



ELECTRONIC COMPONENTS & DEVICES

2016/2017

English

CAT.NO.E1001Q

ALUMINUM ELECTROLYTIC CAPACITORS



Aluminum Electrolytic Capacitors

Product Guide	P2~18
Group Chart	P2~4
Series Table	P5~7
Part Numbering System	P8
Environmental Consideration	P9
Taping Specifications	P10~13
Cut / Formed Lead Type	P14
Minimum Order Quantity	P15
Available Terminals For Snap-in And Screw-Mount Type	P16
Standardization	P17
World-Wide Manufacturing Locations	P18
Conductive Polymer Aluminum Solid Capacitors	P19~65
Precautions and Guidelines	P20~23
Recommended Soldering Conditions	P24
Lifetime Estimation	P25
Part Numbering System	P26
Product List	P27~29
Chip Type	P30~47
Radial Lead Type	P48~63
Conductive Polymer Hybrid Aluminum Electrolytic Capacitors	P65~83
Precautions and Guidelines	P66~69
Recommended Soldering Conditions	P70
Part Numbering System	P71
Chip Type	P72~79
Radial Lead Type	P80~83
Aluminum Electrolytic Capacitors	P85~372
Precautions and Guidelines	P86~89
Recommended Soldering Conditions	P90
Chip Type	P91~132
Radial Lead Type	P133~229
Snap-in Type	P230~288
Screw Terminal Type	P289~354
For Audio	P355~372
Technical Note	P373~386
Reliability Test Data	P387~394
Appendix	P395~399

 : AEC-Q200 compliant. Please contact your local Chemi-Con office for more details, test data, information and also non indicated products.

☆: Recommendation products

CONDUCTIVE POLYMER ALUMINUM SOLID CAPACITORS

RESIN-MOLDED SURFACE MOUNT TYPE

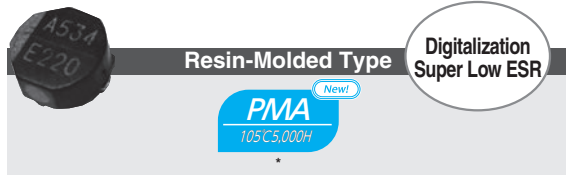

SURFACE MOUNT TYPE (CE32)

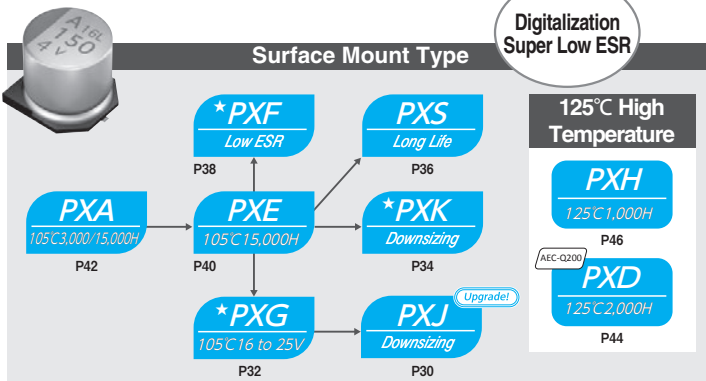

RADIAL LEAD TYPE (CE04)

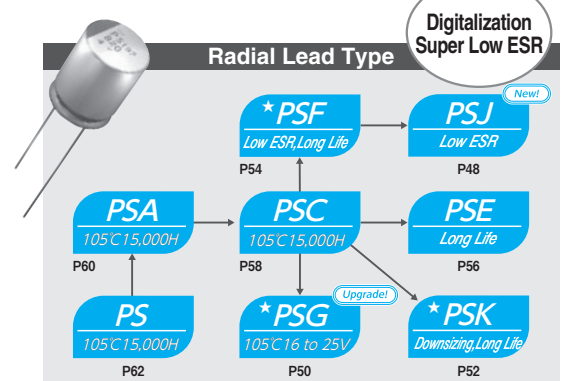

CONDUCTIVE POLYMER HYBRID ALUMINUM ELECTROLYTIC CAPACITORS

SURFACE MOUNT TYPE (CE32)

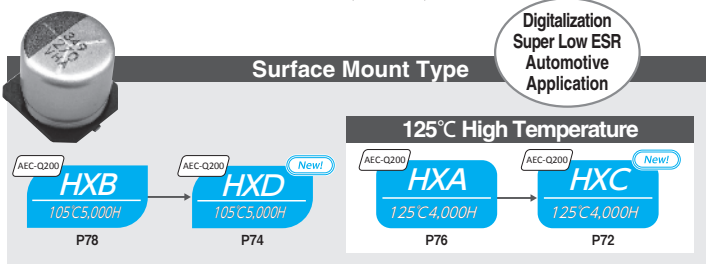

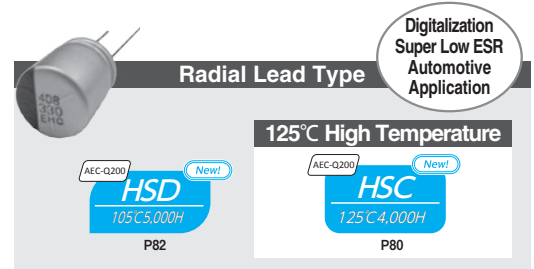

RADIAL LEAD TYPE (CE04)

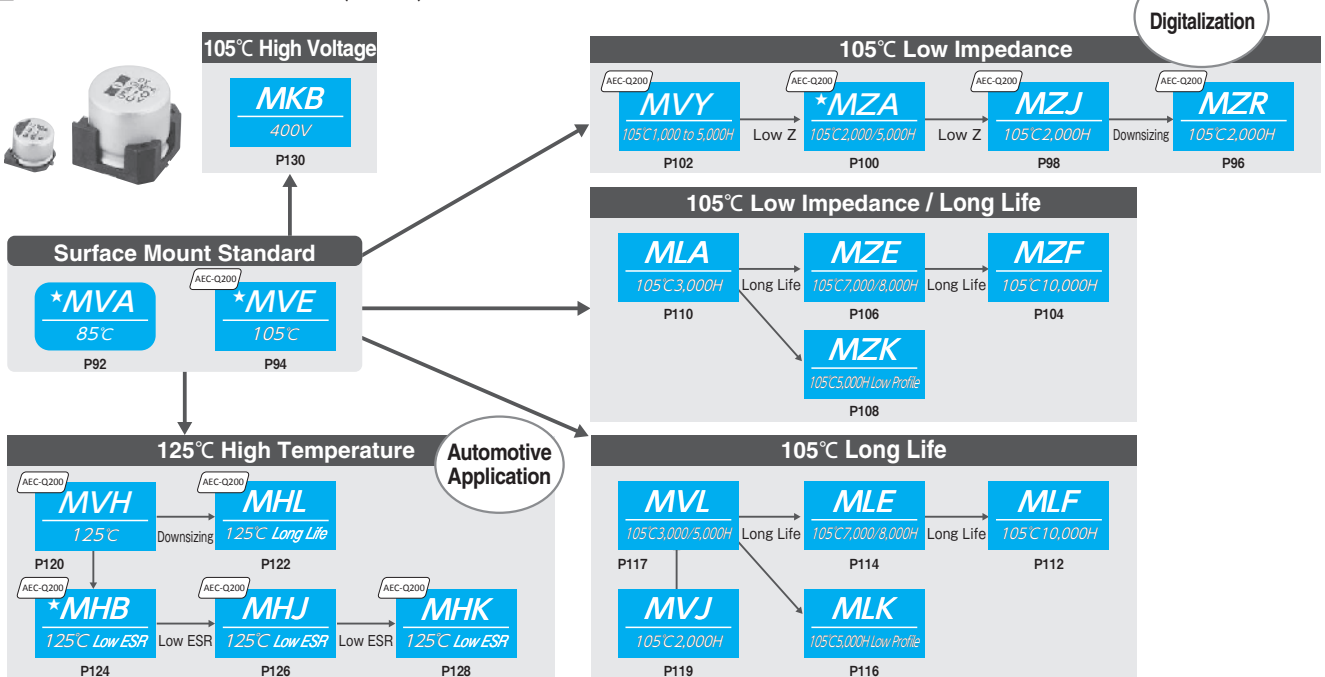

ALUMINUM ELECTROLYTIC CAPACITORS

SURFACE MOUNT TYPE (CE32)



 : AEC-Q200 compliant. Please contact your local Chemi-Con office for more details, test data, information and also non indicated products. ☆: Recommendation products

ALUMINUM ELECTROLYTIC CAPACITORS

■ RADIAL LEAD TYPE

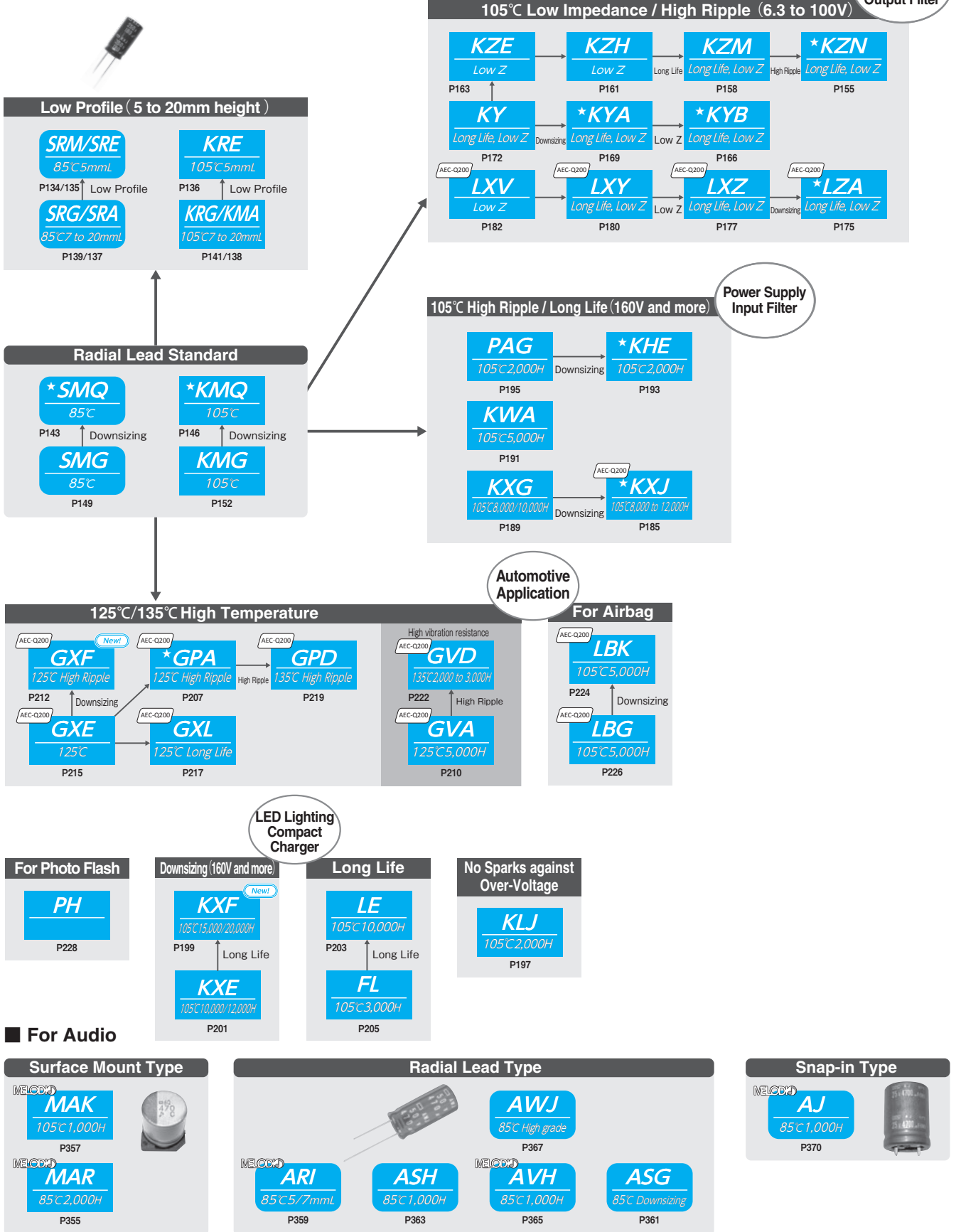

ALUMINUM ELECTROLYTIC CAPACITORS

SNAP-IN TYPE

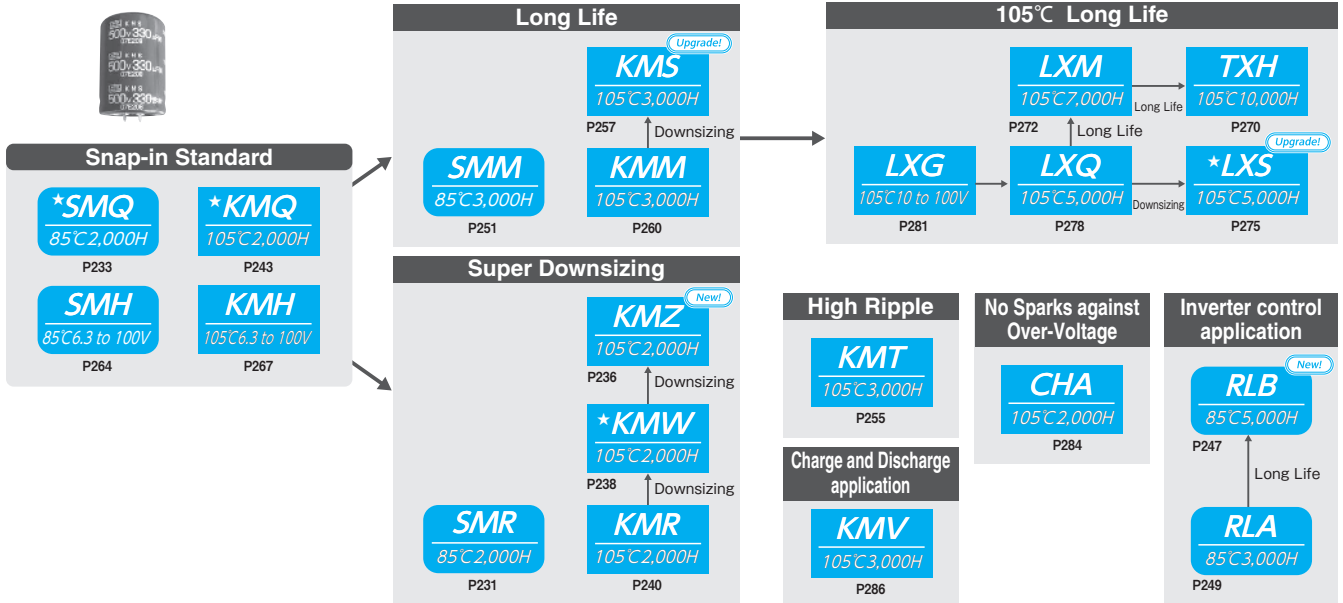

SCREW-MOUNT TYPE

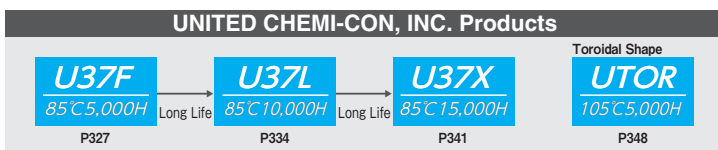
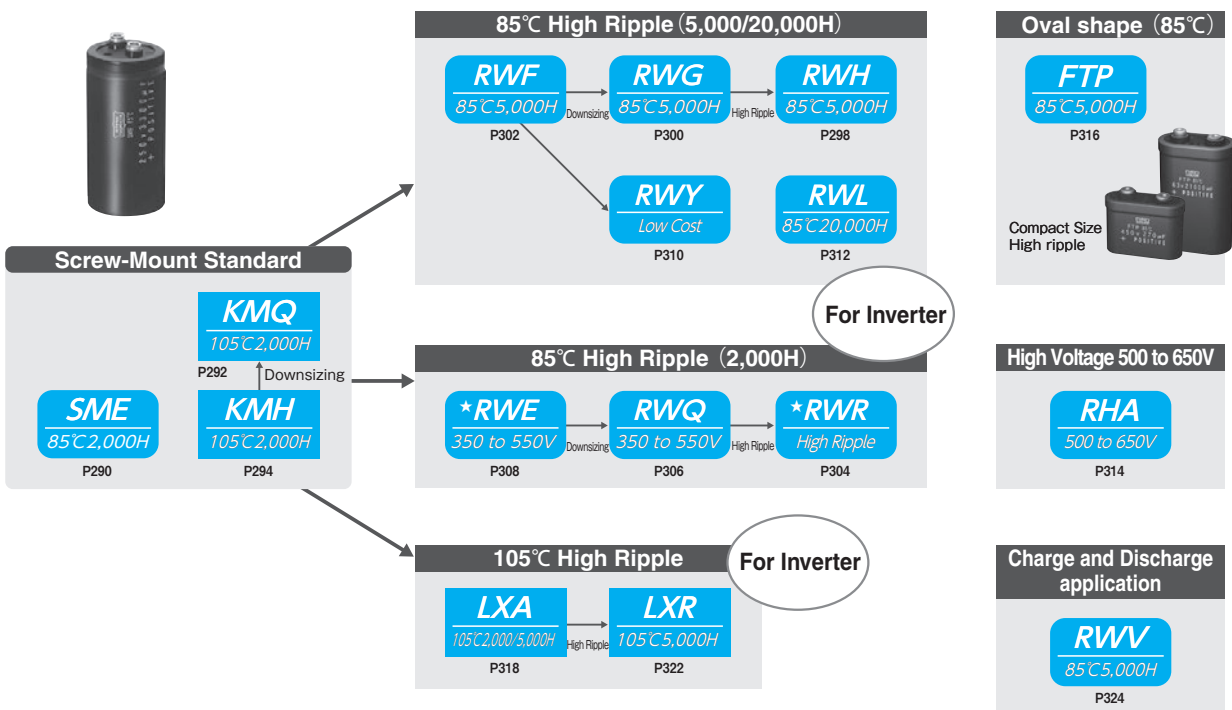



CAPACITOR SERIES TABLE, CONTENTS

■ CONDUCTIVE POLYMER ALUMINUM SOLID CAPACITORS

Series		Page	Features	Standard Type	Miniaturization Low profile type	Low impedance	Long life	High temperature	AEC-Q200	Terminal type	Endurance (+R=With ripple)	Rated voltage range (Vdc)
Resin-Molded Surface Mount Type	PMA (New!)	—	Super low ESR, low profile (Ask Engineering Bulletin No.824 in detail)	●	●					—	105°C 5,000 hours	16 to 25
Surface Mount Type	PXJ (Upgrade!)	30	Super low ESR, high ripple current, downsized	●	●	●				SMD	105°C 15,000 hours	2.5 to 25
	PXG	32	Super low ESR, high ripple current, downsized	●	●	●				SMD	105°C 3,000 to 15,000 hours	16 to 25
	PXK	34	Super low ESR, high ripple current, downsized	●	●	●				SMD	105°C 3,000 to 15,000 hours	2.5 to 16
	PXS	36	Super low ESR, high ripple current	●	●	●				SMD	105°C 20,000 hours	4 to 16
	PXF	38	Super low ESR, high ripple current	●	●	●				SMD	105°C 3,000 to 15,000 hours	2 to 10
	PXE	40	Super low ESR, high ripple current	●	●	●				SMD	105°C 15,000 hours	2.5 to 16
	PXA	42	Super low ESR, high ripple current	●	●	●				SMD	105°C 3,000 to 15,000 hours	2.5 to 25
	PXD	44	125°C, super low ESR, high ripple current	●	●	●	●	●	●	SMD	125°C 2,000 hours	2.5 to 10
PXH	46	125°C, super low ESR, high ripple current	●	●	●		●	●	SMD	125°C 1,000 hours	2.5 to 20	
Radial Lead Type	PSJ (New!)	48	Super low ESR, high ripple current, downsized	●	●					Radial	105°C 2,000 to 5,000 hours	2.5
	PSG (Upgrade!)	50	Super low ESR, high ripple current	●	●	●				Radial	105°C 15,000 to 20,000 hours	16 to 35
	PSK	52	Super low ESR, high ripple current	●	●	●				Radial	105°C 20,000 hours	2.5 to 6.3
	PSF	54	Super low ESR, high ripple current	●	●	●				Radial	105°C 20,000 hours	2 to 16
	PSE	56	Super low ESR, high ripple current	●	●	●				Radial	105°C 20,000 hours	2.5 to 6.3
	PSC	58	Super low ESR, high ripple current	●	●	●				Radial	105°C 15,000 hours	2.5 to 16
	PSA	60	Super low ESR, high ripple current	●	●	●	●			Radial	105°C 15,000 hours	2.5 to 16
PS	62	Super low ESR, high ripple current	●	●	●	●			Radial	105°C 15,000 hours	2.5 to 35	

■ CONDUCTIVE POLYMER HYBRID ALUMINUM ELECTROLYTIC CAPACITORS

Series		Page	Features	Standard Type	Miniaturization Low profile type	Low impedance	Long life	High temperature	AEC-Q200	Terminal type	Endurance (+R=With ripple)	Rated voltage range (Vdc)
Surface Mount Type	HXC (New!)	72	125°C, super low ESR, high ripple current	●	●	●	●	●	●	SMD	125°C 4,000 hours +R	16 to 63
	HXD (New!)	74	Super low ESR, high ripple current	●	●	●			●	SMD	105°C 5,000 hours +R	16 to 63
	HXA	76	125°C, super low ESR, high ripple current		●	●	●	●	●	SMD	125°C 4,000 hours +R	16 to 80
	HXB	78	Super low ESR, high ripple current		●	●			●	SMD	105°C 5,000 hours +R	16 to 80
Radial Lead Type	HSC (New!)	80	125°C, super low ESR, high ripple current	●	●	●	●	●	●	Radial	125°C 4,000 hours +R	25 to 63
	HSD (New!)	82	Super low ESR, high ripple current	●	●	●			●	Radial	105°C 5,000 hours +R	25 to 63

■ ALUMINUM ELECTROLYTIC CAPACITORS

Series		Page	Features	Standard Type	Miniaturization Low profile type	Low impedance	Long life	High temperature	AEC-Q200	Terminal type	Endurance (+R=With ripple)	Rated voltage range (Vdc)	
Surface Mount Type	General Purpose	MVA	92	85°C, standard	●	●				SMD	85°C 2,000 hours	4 to 450	
		MVE	94	105°C, standard	●	●			●	SMD	105°C 1,000 to 2,000 hours	6.3 to 450	
	Low Impedance	MZR	96	Super low ESR, downsized	●	●	●			●	SMD	105°C 2,000 hours	6.3 to 50
		MZJ	98	Super low ESR	●	●	●			●	SMD	105°C 2,000 hours	6.3 to 35
		MZA	100	Super low impedance, Case size 4 to 18mm	●	●	●			●	SMD	105°C 2,000 to 5,000 hours	6.3 to 100
		MVY	102	Low impedance, standard, Case size 4 to 18mm	●	●	●			●	SMD	105°C 1,000 to 5,000 hours	6.3 to 100
		MZF	104	10,000 hours, Long life, low impedance		●	●	●			SMD	105°C 10,000 hours	6.3 to 50
		MZE	106	7,000/8,000 hours, Long life, low impedance		●	●	●			SMD	105°C 7,000 to 8,000 hours	6.3 to 50
		MZK	108	5,000 hours, Long life, low impedance	●	●	●	●			SMD	105°C 5,000 hours	6.3 to 35
		MLA	110	3,000 hours, Long life, low impedance		●	●	●			SMD	105°C 3,000 hours	6.3 to 50
	Long Life	MLF	112	10,000 hours, Long life		●	●	●			SMD	105°C 10,000 hours	6.3 to 50
		MLE	114	7,000/8,000 hours, Long life		●	●	●			SMD	105°C 7,000 to 8,000 hours	6.3 to 50
		MLK	116	5,000 hours, Long life	●	●	●	●			SMD	105°C 5,000 hours	6.3 to 35
		MVL	117	3,000/5,000 hours, Long life		●	●	●			SMD	105°C 3,000 to 5,000 hours	6.3 to 50
		MVJ	119	2,000 hours, Long life		●	●	●			SMD	105°C 2,000 hours	6.3 to 50
	Special Application	MVH	120	125°C, Case size 6.3 to 18mm	●	●	●	●	●	●	SMD	125°C 1,000 to 5,000 hours	10 to 450
		MHL	122	125°C, Downsized		●	●	●	●	●	SMD	125°C 2,000 to 4,000 hours	10 to 35
		MHB	124	125°C, Specified ESR after endurance Case size 8 to 18mm		●	●	●	●	●	SMD	125°C 1,500 to 3,000 hours	10 to 100
		MHJ	126	125°C, Specified ESR after endurance		●	●	●	●	●	SMD	125°C 2,000 to 3,000 hours	10 to 35
		MHK	128	125°C, Specified ESR after endurance		●	●	●	●	●	SMD	125°C 2,000 hours	35
MKB		130	Specified ESR at low temperature		●	●	●	●	●	SMD	105°C 3,000 hours	400	
MV-BP		131	Bi-polar	●	●	●	●			SMD	85°C 2,000 hours	6.3 to 50	
MVK-BP	132	Bi-polar	●	●	●	●			SMD	105°C 1,000 hours	6.3 to 50		

■ : Recommendation products

AEC-Q200 : AEC-Q200 compliant. Please contact your local Chemi-Con office for more details, test data, information and also non indicated products.



CAPACITOR SERIES TABLE, CONTENTS

■ ALUMINUM ELECTROLYTIC CAPACITORS

Series		Page	Features	Standard Type	Miniaturization	Low profile type	Low impedance	Long life	High temperature	AEC-Q200	Terminal type	Endurance (+R=With ripple)	Rated voltage range (Vdc)	
				●	●	●	●	●	●	●				
Radial Lead Type	Low Profile	SRM	134	85°C, 5mm height, downsized	●	●					Radial	85°C 1,000 hours	4 to 50	
		SRE	135	85°C, 5mm height, standard	●	●					Radial	85°C 1,000 hours	4 to 50	
		KRE	136	105°C, 5mm height, standard	●	●						Radial	105°C 1,000 hours	6.3 to 50
		SRA	137	85°C, 7mm height, standard	●	●						Radial	85°C 1,000 hours	4 to 63
		KMA	138	105°C, 7mm height, standard	●	●						Radial	105°C 1,000 hours	4 to 63
		SRG	139	φ 4×7 to φ 18×25mm, low profile	●	●						Radial	85°C 1,000 to 2,000 hours	4 to 50
		KRG	141	φ 4×7 to φ 18×25mm, low profile	●	●						Radial	105°C 1,000 hours	6.3 to 50
	General Purpose	SMQ	143	85°C, Downsized	●	●						Radial	85°C 2,000 hours	6.3 to 450
		KMQ	146	105°C, Downsized	●	●						Radial	105°C 1,000 to 2,000 hours +R	6.3 to 450
		SMG	149	85°C, standard	●	●						Radial	85°C 2,000 hours	6.3 to 450
		KMG	152	105°C, standard	●	●						Radial	105°C 1,000 to 2,000 hours +R	6.3 to 450
		SME-BP	—	Bi-polar, downsized (Ask Engineering Bulletin No.865 in detail)	●	●						Radial	85°C 2,000 hours	6.3 to 100
		KME-BP	—	Bi-polar, downsized (Ask Engineering Bulletin No.866 in detail)	●	●						Radial	105°C 1,000 hours	6.3 to 100
	Power Supply Output, Low Impedance	KZN	155	Long life, low impedance	●	●	●					Radial	105°C 6,000 to 10,000 hours +R	6.3 to 100
		KZM	158	Long life, super low impedance	●	●	●					Radial	105°C 6,000 to 10,000 hours +R	6.3 to 50
		KZH	161	Super low impedance, downsized	●	●	●					Radial	105°C 5,000 to 6,000 hours +R	6.3 to 35
		KZE	163	Low impedance, downsized	●	●	●					Radial	105°C 1,000 to 5,000 hours +R	6.3 to 100
		KYB	166	Low impedance, downsized	●	●	●					Radial	105°C 4,000 to 10,000 hours +R	6.3 to 100
		KYA	169	Low impedance, downsized	●	●	●					Radial	105°C 4,000 to 10,000 hours +R	6.3 to 100
		KY	172	Low impedance, standard	●	●	●					Radial	105°C 4,000 to 10,000 hours +R	6.3 to 100
		LZA	175	Low impedance, downsized	●	●	●				●	Radial	105°C 4,000 to 7,000 hours +R	6.3 to 35
		LXZ	177	Low impedance, downsized	●	●	●				●	Radial	105°C 2,000 to 8,000 hours +R	6.3 to 63
		LXY	180	Low impedance			●	●			●	Radial	105°C 2,000 to 8,000 hours +R	10 to 63
		LXV	182	Low impedance			●	●			●	Radial	105°C 2,000 to 5,000 hours +R	6.3 to 100
	Power Supply Input	KXJ	185	Long life, downsized, for input filtering	●	●			●		●	Radial	105°C 8,000 to 12,000 hours +R	160 to 500
		KXG	189	Long life, downsized, for input filtering	●	●			●			Radial	105°C 8,000 to 10,000 hours +R	160 to 450
		KWA	191	Low profile, long life for input filtering	●	●			●			Radial	105°C 5,000 hours +R	400 to 450
		KHE	193	Low profile, high ripple for input filtering	●	●						Radial	105°C 2,000 hours +R	400 to 450
		PAG	195	Low profile, for input filtering	●	●						Radial	105°C 2,000 hours +R	200 to 450
		KLJ	197	No sparks with DC overvoltage, downsized	●	●						Radial	105°C 2,000 hours +R	200 to 450
		KLG	—	No sparks with DC overvoltage (Ask Engineering Bulletin No.679 in detail)	●	●						Radial	105°C 2,000 hours +R	200 & 400
		KXF (New!)	199	Long life, downsized, for input filtering	●	●			●			Radial	105°C 15,000/20,000 hours +R	160 to 450
		KXE	201	Long life, downsized, for input filtering	●	●			●			Radial	105°C 10,000 to 12,000 hours +R	160 to 400
Power Supply Output	LE	203	Long life, downsized	●	●			●			Radial	105°C 10,000 hours +R	10 to 100	
	FL	205	Long life, downsized	●	●			●			Radial	105°C 3,000 hours +R	6.3 to 50	
High Temperature	GPA	207	125/150°C, downsized (Guaranteed short time at 150°C)	●	●	●	●	●	●	●	Radial	125°C 3,000 to 5,000 hours +R	25 to 100	
	GVA	210	125°C, high vibration resistance	●	●	●	●	●	●	●	Radial	125°C 5,000 hours +R	25 to 100	
	GXF (New!)	212	125°C, high ripple	●	●			●	●	●	Radial	125°C 3,000 hours +R	25 to 400	
	GXE	215	125°C, low impedance, downsized	●	●	●	●	●	●	●	Radial	125°C 2,000 to 5,000 hours +R	10 to 450	
	GXL	217	125°C					●	●	●	Radial	125°C 5,000 hours +R	10 to 50	
	GPD	219	135/150°C, high ripple (Guaranteed short time at 150°C)	●	●	●	●	●	●	●	Radial	135°C 2,000 to 3,000 hours +R	25 to 100	
	GVD	222	135°C, high vibration resistance	●	●	●	●	●	●	●	Radial	135°C 2,000 to 3,000 hours +R	25 to 100	
Special Application	LBK	224	For airbag, downsized	●	●	●				●	Radial	105°C 5,000 hours +R	25 & 35	
	LBG	226	For airbag	●	●	●				●	Radial	105°C 5,000 hours +R	25 & 35	
	PH	228	For photo flash	●	●						Radial	55°C 5,000 times charging	300 & 330	

■ : Recommendation products

AEC-Q200 : AEC-Q200 compliant. Please contact your local Chemi-Con office for more details, test data, information and also non indicated products.



CAPACITOR SERIES TABLE, CONTENTS

ALUMINUM ELECTROLYTIC CAPACITORS

Series		Page	Features	Standard Type	Miniaturization Low profile type	High ripple	Long life	Terminal type	Endurance (+R=With ripple)	Rated voltage range (V _{dc})	
Snap-in Type	General Purpose	SMR	231	85°C, high ripple, downsized	●	●		Pin	85°C 2,000 hours +R	400 to 450	
		SMQ	233	85°C, standard	●	●		Pin	85°C 2,000 hours +R	160 to 450	
		KMZ <small>(New!)</small>	236	105°C, super downsized		●			Pin	105°C 2,000 hours +R	420 & 450
		KMW	238	105°C, super downsized		●			Pin	105°C 2,000 hours +R	400 to 450
		KMR	240	105°C, downsized		●			Pin	105°C 2,000 hours +R	160 to 450
		KMQ	243	105°C, standard	●		●		Pin	105°C 2,000 hours +R	35, 50, 160 to 450
		RLB <small>(New!)</small>	247	85°C, 5,000 hours, high ripple		●	●		Pin	85°C 5,000 hours +R	180 to 250
		RLA	249	85°C, high ripple		●	●		Pin	85°C 3,000 hours +R	180 to 250
		SMM	251	85°C, 3,000 hours	●		●	●	Pin	85°C 3,000 hours +R	160 to 450
		KMT	255	105°C, high ripple			●		Pin	105°C 3,000 hours +R	420 & 450
		KMS <small>(Upgrade!)</small>	257	105°C, downsized	●	●	●	●	Pin	105°C 3,000 hours +R	160 to 550
		KMM	260	105°C, 3,000 hours	●		●	●	Pin	105°C 3,000 hours +R	160 to 450
	SMH	264	85°C, standard <small>(Ask Engineering Bulletin No.585 for 160 to 450V)</small>					Pin	85°C 2,000 hours +R	6.3 to 100	
	KMH	267	105°C, standard <small>(Ask Engineering Bulletin No.584 for 160 to 450V)</small>					Pin	105°C 2,000 hours +R	6.3 to 100	
	Low Profile	SLM	—	15mm height, low profile <small>(Ask Engineering Bulletin No.854 in detail)</small>		●			Pin	85°C 2,000 hours +R	160 to 400
		KLM	—	15mm height, low profile <small>(Ask Engineering Bulletin No.855 in detail)</small>		●			Pin	105°C 2,000 hours +R	160 to 400
	High Temperature	TXH	270	Long life				●	Pin	105°C 10,000 hours +R	200 to 450
		LXM	272	Long life, downsized		●		●	Pin	105°C 7,000 hours +R	160 to 450
		LXS <small>(Upgrade!)</small>	275	Long life, downsized	●	●	●	●	Pin	105°C 5,000 hours +R	160 to 550
		LXQ	278	Long life, downsized		●		●	Pin	105°C 5,000 hours +R	160 to 450
Special Application	LXG	281	Long life				●	Pin	105°C 5,000 hours +R	10 to 100	
	CHA	284	No sparks with DC overvoltage				●	Pin	105°C 2,000 hours +R	200 to 450	
	LXH	—	No sparks with DC overvoltage <small>(Ask Engineering Bulletin No.856 in detail)</small>		●	●	●	Pin	105°C 3,000/5,000 hours +R	200 & 400	
	KMV	286	For charge and discharge application					Pin	105°C 3,000 hours +R	350 to 450	
Screw-Mount Type	General Purpose	SME	290	85°C, standard <small>(Ask Engineering Bulletin No.548 for 160 to 250V)</small>	●			Screw	85°C 2,000 hours +R	10 to 100	
		KMQ	292	105°C, downsized		●		Screw	105°C 2,000 hours +R	315 to 450	
		KMH	294	105°C, standard	●			Screw	105°C 2,000 hours +R	10 to 400	
	For Inverter	RWH	298	High ripple, downsized		●	●	●	Screw	85°C 5,000 hours +R	350 to 450
		RWG	300	Long life, high ripple, downsized		●	●	●	Screw	85°C 5,000 hours +R	350 to 450
		RWF	302	Long life, high ripple		●	●	●	Screw	85°C 5,000 hours +R	350 to 450
		RWR	304	High ripple, downsized		●	●	●	Screw	85°C 2,000 hours +R	350 to 450
		RWQ	306	High ripple, downsized	●		●	●	Screw	85°C 2,000 hours +R	350 to 550
		RWE	308	High ripple	●	●	●		Screw	85°C 2,000 hours +R	350 to 550
		RWY	310	Long life, high ripple, low cost				●	Screw	85°C 5,000 hours +R	350 to 450
		RWL	312	Long life, high ripple				●	Screw	85°C 20,000 hours +R	350 to 450
		RHB <small>(New!)</small>	—	85°C, high voltage <small>(Ask Engineering Bulletin No.846 in detail)</small>					Screw	85°C 2,000 hours +R	575 to 700
		RHA	314	High voltage, high ripple		●	●	●	Screw	85°C 5,000 hours +R	500 to 650
		FTP	316	Ovalized can shape, high ripple		●	●	●	Screw	85°C 5,000 hours +R	63 to 450
		LXA	318	105°C, long life		●		●	Screw	105°C 2,000/5,000 hours +R	10 to 525
		LXR	322	105°C, long life, high ripple			●	●	Screw	105°C 5,000 hours +R	350 to 450
RWV	324	For charge and discharge application					Screw	85°C 5,000 hours +R	350 to 450		

ALUMINUM ELECTROLYTIC CAPACITORS (UNITED CHEMI-CON, INC. Products)

Series		Page	Features	Standard Type	Miniaturization Low profile type	High ripple	Long life	Terminal type	Endurance (+R=With ripple)	Rated voltage range (V _{dc})
Screw-Mount Type	For Inverter	U37F	327	Long life, high ripple		●	●	Screw	85°C 5,000 hours +R	350 to 500
		U37L	334	Long life, high ripple		●	●	Screw	85°C 10,000 hours +R	350 to 500
		U37X	341	Long life, high ripple		●	●	Screw	85°C 15,000 hours +R	350 to 500
		UTOR	348	Toroidal shape, long life, high ripple			●	●	Screw	105°C 5,000 hours +R

ALUMINUM ELECTROLYTIC CAPACITORS FOR AUDIO

Series		Page	Features	Standard Type	Miniaturization Low profile type	Terminal type	Endurance (+R=With ripple)	Rated voltage range (V _{dc})
For Audio	MAR <small>MELODIO</small>	355	Surface mount type	●	●	SMD	85°C 2,000 hours	6.3 to 50
	MAK <small>MELODIO</small>	357	105°C, Surface mount type			SMD	105°C 1,000 hours	6.3 to 50
	ARI <small>MELODIO</small>	359	5mm / 7mm height	●	●	Radial	85°C 1,000 hours	6.3 to 50
	ASG	361	Standard, downsized		●	Radial	85°C 2,000 hours	6.3 to 100
	ASH	363	Standard	●	●	Radial	85°C 1,000 hours	6.3 to 100
	AVH <small>MELODIO</small>	365	Standard		●	Radial	85°C 1,000 hours	6.3 to 100
	AWJ	367	High grade			Radial	85°C 1,000 hours	16 to 100
	SNX-BP	369	General purpose speaker network		●	Radial	85°C 1,000 hours	63
	AJ <small>MELODIO</small>	370	For input filtering, snap-in type		●	Pin	85°C 1,000 hours	25 to 25

● : Recommendation products



PART NUMBERING SYSTEM

Part numbering system

Our part numbering system is common to all of Nippon Chemi-Con's subsidiaries worldwide, and has been switching the conventional part numbering system. The part number uses 18-digit codes to express information of principal product specifications such as product category, series name, rated voltage, capacitance, case size and RoHS compliance.

●Categories

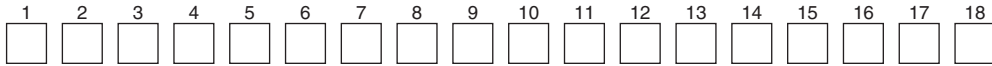

Code	Details
A	Conductive Polymer Aluminum Solid Capacitors (Polar)
H	Conductive Polymer Hybrid Aluminum Electrolytic Capacitors (Polar)
E	Aluminum Electrolytic Capacitors (Polar)
B	Aluminum Electrolytic Capacitors (Bi-polar)
K	Multilayer Ceramic Capacitors
F	Film Capacitors
D	Electric Double Layer Capacitors
T	Metal Oxide Varistors
L	Amorphous Choke Coils

●Example

Product type	Part number (Example)	Conventional part number (Ref.)
Surface mount type	EMVE160ADA100MD55G	MVE16VC10MD55E0
Radial lead type	EKM6R3ETC102MHB5D	TC04RKM6.3VB1000MF50E0
Snap-in type	EKM201VSN471MP30S	KMQ200VSSN470M22BE0
Screw mount terminal type	ERWE551LGC821MCD0M	RWE550LGSN820MCC13EA



Environment friendly capacitors

Nippon Chemi-Con always considers the environment in product materials, designs and manufacturing. In fact, our factories already have received ISO 14000 certificate. Cadmium, Mercury, Hexavalent Chromium, PBB and PBDE have never been used in our products. Furthermore, lead-containing materials have been eliminated from all our aluminum electrolytic capacitors including Conductive Polymer Aluminum Solid Capacitors to comply with RoHS. If you need "Halogen-Free" products, please consult with us.

◆Lead free and Non-PVC Products

1. Lead wire (Plating)

Category		Plating material on lead wires	
Conductive Polymer Aluminum Solid Capacitors	Resin-Molded Chip	Sn	
	Chip	Sn-Bi	
	Radial	Sn	
Conductive Polymer Hybrid Aluminum Electrolytic Capacitors	Chip	Sn-Bi	
	Radial	Sn	
Aluminum Electrolytic Capacitors	Chip	case code : D55 to JA0	Sn-Bi
		case code : KE0 to MN0	Sn
	Radial	case dia : to $\phi 8$	Sn-Bi
		case dia : $\phi 10$ to	Sn
	Snap-in	Sn	
Screw-Mount	Originally lead-free		

*Please consult with us when you need "Lead-free parts" other than the above mentioned terminal plating materials.

(Note) **Sn** : Tin, **Bi** : Bismuth

2. Sleeve

Category		Sleeve material	
Conductive Polymer Aluminum Solid Capacitors	Resin-Molded Chip	Sleeveless (Resin-Molded case)	
	Chip	Sleeveless (Coating case)	
	Radial	Sleeveless (Coating case)	
Conductive Polymer Hybrid Aluminum Electrolytic Capacitors	Chip	Sleeveless (Coating case)	
	Radial	Sleeveless (Coating case)	
Aluminum Electrolytic Capacitors	Chip	Sleeveless (Coating case)	
	Radial	$\phi 8 \times 5L$	Sleeveless (Coating case)
		except $\phi 8 \times 5L$	PET
	Snap-in	PET	
Screw-Mount	PVC		

*Please consult with us when you need "Non-PVC parts" other than the above mentioned outer sleeve materials.

The colors of a PET sleeve are "Black", "Brown", and "Dark blue".

Standard designs of "lead-free" Snap-in type are not equipped with a plastic disc.

Please consult with us when you need nonflammable grade for outer sleeve material.

Identification of friendly parts is given by a supplement code (18th digit) of the part number.

For details, please refer to "Product code guide" for each type.

◆Regarding compliance for EU REACH Regulation

1) According to the content of REACH handbook (Guidance on requirements for substances in articles which is published on May 2008), our electronic components are "articles without any intended release". Therefore they are not applicable for "Registration" for EU REACH Regulation Article 7 (1).

Reference: Electrolytic Condenser Investigation Society

"Study of REACH Regulation in EU about Electrolytic Capacitor" (publicized on 13 March 2008)

2) Nippon Chemi-Con develops the products without substance of very high concern (SVHC). DEHP (CAS No. 117-81-7) was contained as some covering material, Nippon Chemi-Con abolished use of DEHP totally at June, 2011.

TAPING SPECIFICATIONS (Applicable standard JIS C 0806-3)

SURFACE MOUNT TYPE (TAPING)



◆CARRIER TAPE [mm]

Fig.1

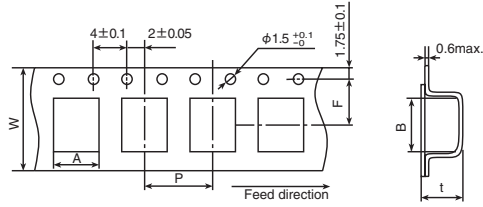

Fig.4

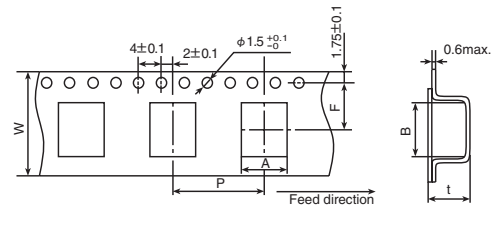

Fig.2

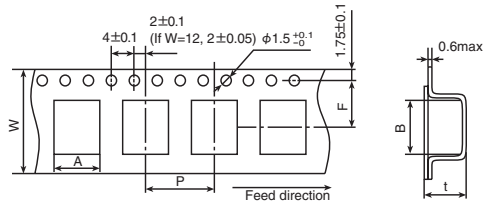

Fig.5

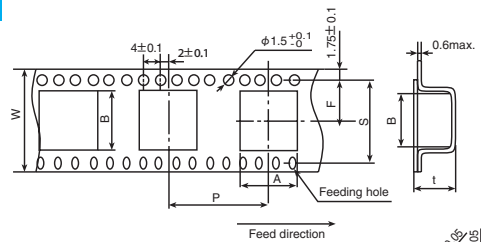
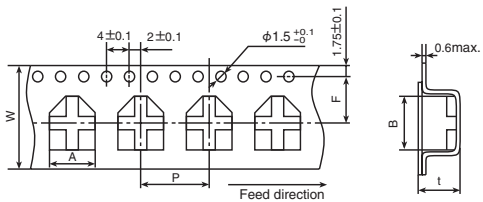

Fig.3



[mm]

Series	Items	W	A	B	F	P	t	S	Fig.	
		±0.3	±0.2	±0.2	±0.1	±0.1	±0.2	±0.1		
Alchip™	D55	12.0	4.7	4.7	5.5	8.0	5.7	—	1	
	D60,D61	12.0	4.7	4.7	5.5	8.0	6.3	—	1	
	D73	12.0	4.6	4.6	5.5	8.0	7.5	—	1	
	E40	12.0	5.7	5.7	5.5	12.0	4.4	—	2	
	E46	12.0	5.7	5.7	5.5	12.0	4.9	—	2	
	E55	12.0	5.7	5.7	5.5	12.0	5.7	—	2	
	E60,E61	12.0	5.7	5.7	5.5	12.0	6.3	—	2	
	E73	16.0	5.7	5.7	7.5	12.0	7.5	—	2	
	F35	16.0	7.5	8.0	7.5	12.0	4.4	—	3	
	F45,F46	16.0	7.0	7.0	7.5	12.0	4.9	—	2	
	F55	16.0	7.0	7.0	7.5	12.0	5.7	—	2	
	F60,F61	16.0	7.0	7.0	7.5	12.0	6.3	—	2	
	F73	16.0	7.0	7.0	7.5	12.0	7.5	—	2	
	F80	16.0	7.0	7.0	7.5	12.0	8.2	—	2	
	F90	16.0	7.0	7.0	7.5	12.0	9.2	—	2	
	FA0	16.0	7.0	7.0	7.5	12.0	10.3	—	2	
	H63	16.0	8.7	8.7	7.5	12.0	6.8	—	2	
	H70	24.0	8.7	8.7	11.5	12.0	7.3	—	2	
	H80	24.0	8.7	8.7	11.5	12.0	8.3	—	2	
	NPCAP™	HA0	24.0	8.7	8.7	11.5	16.0	11.0	—	4
HC0		24.0	8.7	8.7	11.5	16.0	12.7	—	4	
J80		24.0	10.7	10.7	11.5	16.0	8.3	—	4	
JA0		24.0	10.7	10.7	11.5	16.0	11.0	—	4	
JC0		24.0	10.7	10.7	11.5	16.0	12.8	—	4	
Hybrid		KE0	32.0	13.4	13.4	14.2	24.0	14.0	28.4	5
		KG5	32.0	13.4	13.4	14.2	24.0	16.5	28.4	5
		LH0	44.0	17.5	17.5	20.2	28.0	16.8	40.4	5
		LN0	44.0	17.5	17.5	20.2	28.0	22.1	40.4	5
		MH0	44.0	19.5	19.5	20.2	32.0	17.1	40.4	5
	MN0	44.0	19.5	19.5	20.2	32.0	22.1	40.4	5	
	PMA	24.0	8.7	8.7	11.5	12.0	7.3	—	2	
	PXJ/PXG	24.0	8.7	8.7	11.5	12.0	8.3	—	2	
PXK/PXS	24.0	8.7	8.7	11.5	16.0	11.0	—	4		
PXF/PXE	24.0	8.7	8.7	11.5	16.0	12.7	—	4		
PXA/PXD	24.0	10.7	10.7	11.5	16.0	8.3	—	4		
PXH	24.0	10.7	10.7	11.5	16.0	11.0	—	4		

Product specifications in this catalog are subject to change without notice. Request our product specifications before purchase and/or use. Please use our products based on the information contained in this catalog and product specifications.

NIPPON CHEMI-CON

PACKAGING

◆ REEL DIMENSIONS [mm]

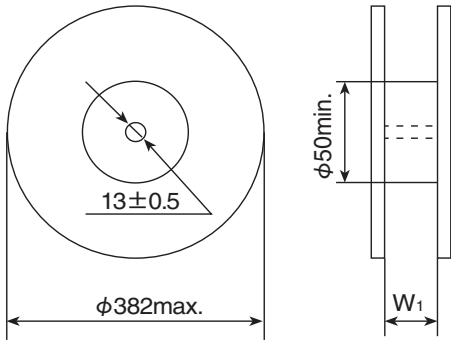

◆ POLARITY

- Alchip™ -MVA/MVE/MZR
MZJ/MZA/MVY
MZJ/MZA/MVY
MZJ/MZA/MVY
MLA/MLF/MLE
MLK/MVL/MVJ
MVH/MHL/MHB
MHJ/MHK/MKB
MV-BP/MVK-BP
- NP CAP™ -PMA
PXJ/PXG/PXK
PXS/PXF/PXE
PXA/PXD/PXH
- Hybrid -HXC/HXD/HXA
HXB

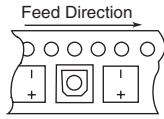

◆ QUANTITY PER REEL/BOX

Series	Size code	Quantity (pcs/reel)	Quantity (pcs/box)	W ₁ (mm)	
Alchip™	D55,D60,D61	2,000	10,000	14	
	D73	1,500	7,500	14	
	MVA/MVE	1,000	5,000	14	
	MZR/MZJ	1,000	5,000	18	
	MZA/MVY	1,000	5,000	18	
	MZF/MZE	1,000	5,000	18	
	MZK/MLA	900	4,500	18	
	MLF/MLE	800	4,000	18	
	MLK/MVL	1,000	5,000	18	
	MVJ/MVH	500	1,500	26	
	MHL/MHB	500	1,500	26	
	MHJ/MHK	250* ¹	750* ¹	34	
	MKB/MV-BP	200* ¹	600* ¹	34	
	MVK-BP	175* ¹	350* ¹	46	
Hybrid	LN0	125* ¹	250* ¹	46	
	MH0	150* ¹	300* ¹	46	
	MN0	100* ¹	200* ¹	46	
NPCAP™	D55	2,000	20,000	14	
	E40,E46,E60,E61	1,000	10,000	14	
	F35,F45,F46,F55,F60,F61	1,000	7,000	18	
	F80	900	6,300	18	
	FA0	750	5,250	18	
	H70	1,000	6,000	26	
	H80	900	5,400	26	
	HA0	500	3,000	26	
	HC0	400	1,200	26	
	J80	500	3,000	26	
	JA0	500	3,000	26	
	JC0	400	1,200	26	
	PMA	PXJ/PXG	1,000	6,000	26
		PXK/PXS	900	5,400	26
PXF/PXE		500	3,000	26	
PXA/PXD	PXH	400	1,200	26	
		500	3,000	26	
		400	1,200	26	

*1 : Changed the packing quantity. (Size Code : KE0 to MN0)

SURFACE MOUNT TYPE (TRAY)

◆ DIMENSIONS [mm]

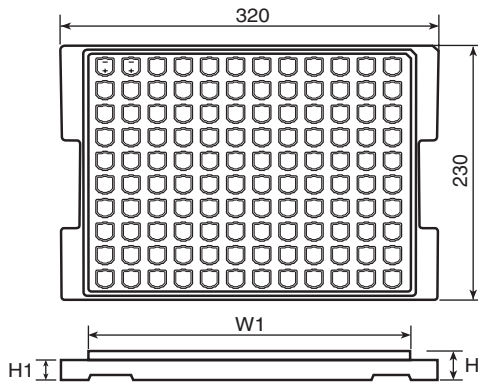

● TRAY CODE : TR

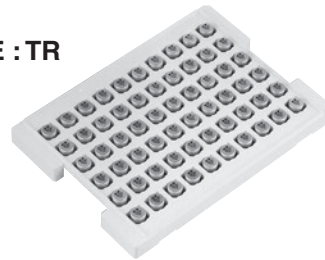

Size code	H [mm]	W ₁ [mm]	H ₁ [mm]	Quantity [pcs/tray]	Quantity [pcs/box]
KE0 & KG5	21.0	284	18.5	120	600
LH0 & LN0	28.0	284	24.0	80	400
MH0 & MN0	28.0	284	24.0	60	300

VIBRATION RESISTANT STRUCTURE (Terminal code : G)

◆ DIMENSIONS [mm]

- Terminal code : G
- Size code : HA0 to JA0

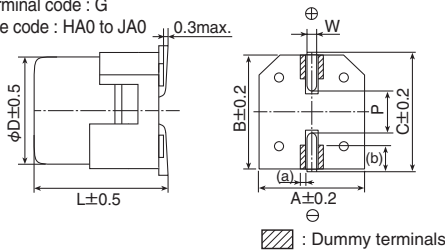

- Size code : KE0 to MN0

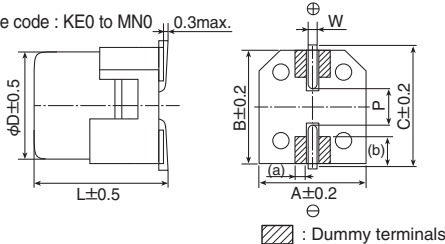

◆ RECOMMENDED SOLDER LAND

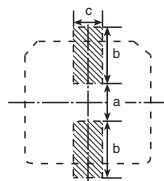

Solder land on PC board

Size code	Dimensions of products (mm)									Solder land (mm)		
	D	L	A	B	C	W	P	(a)	(b)	a	b	c
HA0	8.0	10.0	8.3	8.3	9.0	0.7 to 1.1	3.1	(0.5)	(1.8)	3.1	4.2	3.5
JA0	10.0	10.0	10.3	10.3	11.0	0.7 to 1.1	4.5	(0.5)	(2.1)	4.5	4.4	3.5
KE0	12.5	13.5	13.0	13.0	13.7	1.0 to 1.3	4.2	(1.3)	(3.0)	3.4	6.3	9.3
KG5	12.5	16.0	13.0	13.0	13.7	1.0 to 1.3	4.2	(1.3)	(3.0)	3.4	6.3	9.3
LH0	16.0	16.5	17.0	17.0	18.0	1.0 to 1.3	6.5	(2.0)	(3.0)	4.7	7.8	9.6
LN0	16.0	21.5	17.0	17.0	18.0	1.0 to 1.3	6.5	(2.0)	(3.0)	4.7	7.8	9.6
MH0	18.0	16.5	19.0	19.0	20.0	1.0 to 1.3	6.5	(2.0)	(4.0)	4.7	8.8	9.6
MN0	18.0	21.5	19.0	19.0	20.0	1.0 to 1.3	6.5	(2.0)	(4.0)	4.7	8.8	9.6

() : Ref.

RADIAL LEAD TYPE TAPING SPECIFICATIONS (Applicable standard JIS C 0806-2)

Conductive Polymer Aluminum Solid Capacitors
Conductive Polymer Hybrid Aluminum Electrolytic Capacitors

◆ **DIMENSION [mm]**

Fig.1

Taping Code : TX
 $\phi D = \phi 5$

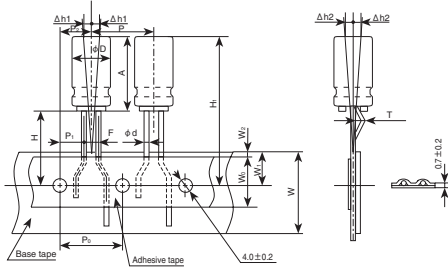
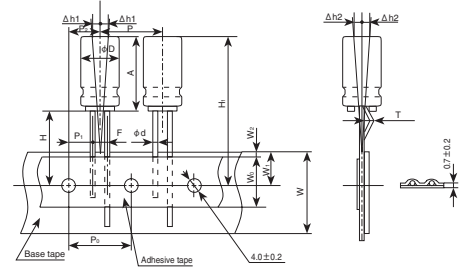

Fig.2

Taping Code : TD
 $\phi D = \phi 6.3$ to 10



Code	Taping Code	Case size		ϕd	P	P_0	P_1	P_2	F	W	W_0	W_1	W_2	H	H_1	ϕD_0	Δh_1	Δh_2	t	T	Fig
		ϕD	A																		
tol.	—	—	—	± 0.05	± 1.0	± 0.2	± 0.7	± 1.0	± 0.2	± 0.5	min.	± 0.5	max.	± 0.75	max.	± 0.2	± 0.2	± 0.2	± 0.3	± 1.0	
Nominal	TX	5	8	0.45^{*1}	12.7	12.7	5.35	6.35	2.0^{*2}	18	10	9.0	2.5	18.5	28.25	4.0	0	0	0.7	0	1
		6.3	5	0.45	12.7	12.7	5.1	6.35	2.5	18	10	9.0	2.5	18.5	28.25	4.0	0	0	0.7	0	2
		6.3	8	0.6	12.7	12.7	5.1	6.35	2.5	18	10	9.0	2.5	18.5	28.75^{*1}	4.0	0	0	0.7	0	2
		6.3	10.5	0.5	12.7	12.7	5.1	6.35	2.5	18	10	9.0	2.5	18.5	30.05	4.0	0	0	0.7	0	2
		8	6	0.6	12.7	12.7	4.6	6.35	3.5	18	10	9.0	2.5	20.0	28.25^{*1}	4.0	0	0	0.7	0	2
	TD	8	8	0.6	12.7	12.7	4.6	6.35	3.5	18	10	9.0	2.5	20.0	29.75	4.0	0	0	0.7	0	2
		8	11.5	0.6^{*1}	12.7	12.7	4.6	6.35	3.5	18	10	9.0	2.5	20.0	33.75	4.0	0	0	0.7	0	2
		8	16	0.6	12.7	12.7	4.6	6.35	3.5	18	10	9.0	2.5	20.0	38.25	4.0	0	0	0.7	0	2
		8	20	0.6	12.7	12.7	4.6	6.35	3.5	18	10	9.0	2.5	20.0	42.25	4.0	0	0	0.7	0	2
		10	10.5	0.6	12.7	12.7	3.85	6.35	5.0	18	10	9.0	2.5	18.5	30.75	4.0	0	0	0.7	0	2
		10	11.5	0.6^{*1}	12.7	12.7	3.85	6.35	5.0	18	10	9.0	2.5	18.5	32.25	4.0	0	0	0.7	0	2
		10	12.5	0.6	12.7	12.7	3.85	6.35	5.0	18	10	9.0	2.5	18.5	33.25	4.0	0	0	0.7	0	2
		10	16	0.6	12.7	12.7	3.85	6.35	5.0	18	10	9.0	2.5	18.5	36.75	4.0	0	0	0.7	0	2
		10	20	0.6	12.7	12.7	3.85	6.35	5.0	18	10	9.0	2.5	18.5	40.75	4.0	0	0	0.7	0	2

* 1 : Each product family has different value. Please refer to each page.
* 2 : For case size $\phi 5 \times 8$ (Taping code : TX), H dimension shall be $2.0^{+0.5/-0.2}$.

TAPING CODE

Example

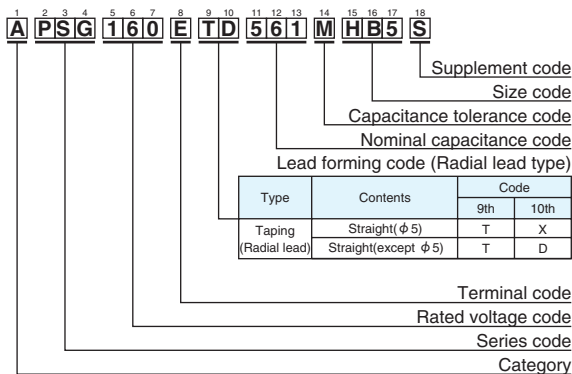

QUANTITY PER AMMO PACK

Ammo pack box

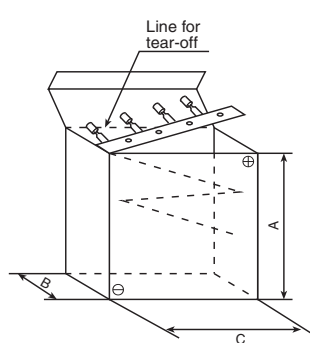

Typical example

Case size $\phi D \times L$ (mm)	A (mm)	B (mm)	C (mm)	Quantity (pcs.)
$\phi 5$ L=8mm	240	51	336	2,000
L=5 & 8mm	285	51	336	
$\phi 6.3$ L=10.5mm	284	51	336	2,000
L=6 to 11.5mm	240	51	336	
$\phi 8$ L=16mm	240	56	336	1,000
L=20mm	240	62	336	
$\phi 10$ L=10.5 to 12.5mm	190	51	337	500
L=16mm	308	56	337	
L=20mm	308	62	337	800

RADIAL LEAD TYPE TAPING SPECIFICATIONS (Applicable standard JIS C 0806-2)

Aluminum Electrolytic Capacitors

◆ DIMENSION [mm]

Fig.1

Taping Code : TA, TC
 $\phi D = \phi 4$ to 8

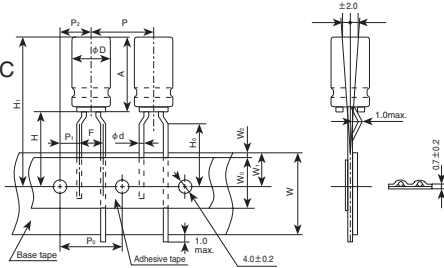

Fig.2

Taping Code : TD
 $\phi D = \phi 5$
 $\phi D \times L = \phi 4 \times 7$

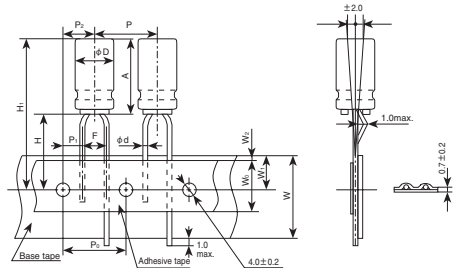

Fig.3

Taping Code : TD
 $\phi D = \phi 6.3$ to 12.5

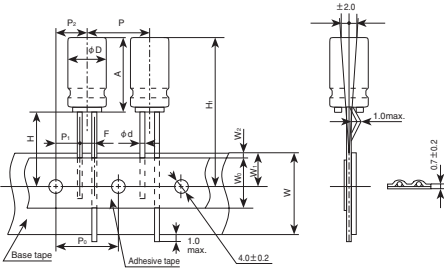
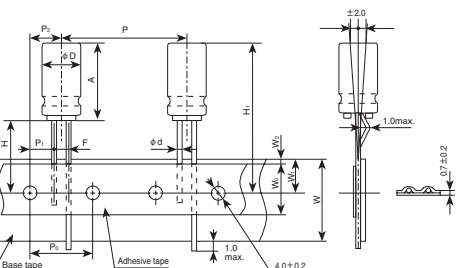

Fig.4

Taping Code : TE
 $\phi D = \phi 12.5$



Code	Taping Code	Case size		ϕd	P	P_0	P_1	P_2	F	W	W_0	W_1	W_2	H	H_0	H_1	Fig
		ϕD	A														
tol.		—	—	± 0.05	± 1.0	± 0.2	± 0.7	± 1.0	± 0.2	± 0.5	min.	± 0.5	max.	± 0.75	± 0.5		
Nominal	TA	4	5	0.45	12.7	12.7	5.1 3.85	6.35	2.5 5	18.0	6.0	9.0	1.5	17.5	16.0	Check insertion machine specs. H1=H+A	1
	TC		7	0.45	12.7	12.7	5.1 3.85	6.35	2.5 5	18.0	6.0	9.0	1.5	17.5	16.0		2
	TD		11.5	0.45	12.7	12.7	5.1 3.85	6.35	2.5 5	18.0	10.0	9.0	1.5	17.5	16.0		1
	TC		5 to 7	0.45	12.7	12.7	5.1 3.85	6.35	2.5 5	18.0	6.0	9.0	1.5	17.5	16.0		2
	TD	9 to 15	0.5 ^{*2}	12.7	12.7	5.1 3.85	6.35	2.5 5	18.0	10.0	9.0	1.5	18.5	16.0	2		
	TC														1		
	TD	6.3	5 to 7	0.45	12.7	12.7	5.1 3.85	6.35	2.5 5	18.0	6.0	9.0	1.5	17.5	16.0		3
	TC																1
	TD	9 to 15	0.5	12.7	12.7	5.1 3.85	6.35	2.5 5	18.0	10.0	9.0	1.5	18.5	16.0	3		
	TC														1		
	TD	8	5	0.45	12.7	12.7	5.1 3.85	6.35	2.5 5	18.0	6.0	9.0	1.5	17.5	16.0		3
	TC																1
	TD		7	0.45	12.7	12.7	3.85	6.35	5	18.0	6.0	9.0	1.5	17.5	16.0		1
	TC																1
	TD	9 to 20	0.6	12.7	12.7	4.6 3.85	6.35	3.5 5	18.0	10.0	9.0	1.5	20.0	16.0	3		
	TC														1		
tol.		± 0.5	max.	± 0.05	± 1.0	± 0.3	± 0.7	± 1.3	± 0.2	± 0.5	min.	± 0.5	max.	± 0.75	—		
Nominal	TD	10	21	0.6 ^{*2}	12.7	12.7	3.85	6.35	5	18.0	12.5	9.0	1.5	18.0	—		3
	TD	12.5	26	0.6 ^{*2}	15	15	5.0	7.5	5	18.0	12.5	9.0	1.5	18.0	—		3
	TE			0.6 ^{*2}	25.4	12.7	3.85	6.35	5	18.0	12.5	9.0	1.5	18.0	—		4

* 1 : Each product family has different value. Please refer to each page.
 * 2 : For case size $\phi 4 \times 7$ (Taping code : TD), H dimension shall be $18.5^{+0.5/-0.75}$.
 * 3 : The taping for size $\phi 16$ and $\phi 18$ is available as a custom design.

TAPING CODE

Example

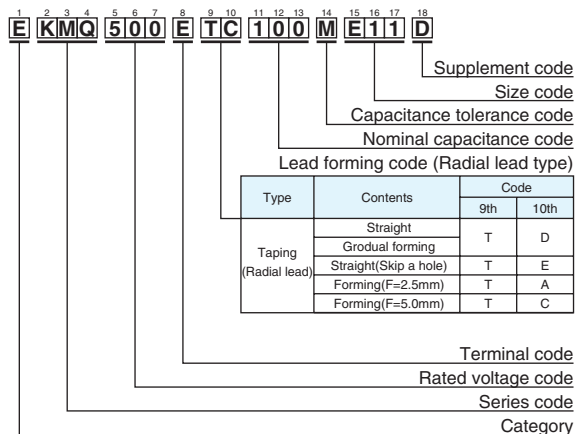

QUANTITY PER AMMO PACK

Ammo pack box

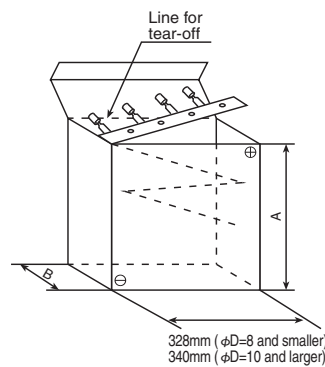

Typical example

Case size $\phi D \times L$ (mm)	A (mm)	B (mm)	Quantity (pcs.)
$\phi 4$	L=5 & 7mm	183	42
	L=11.5mm	183	51
$\phi 5$	L=5 & 7mm	232	42
	L=9 to 15mm	232	51
$\phi 6.3$	L=5 & 7mm	282	42
	L=9 to 15mm	284	51
$\phi 8$	L=5 & 7mm	232	42
	L=9 to 15mm	232	51
$\phi 10$	L=5 & 7mm	308	56
	L=17 & 20mm	308	62
	L=21 to 25mm	308	67
$\phi 12.5$	L=5 & 7mm	308	62
	L=17 to 25mm	308	67

RADIAL LEAD TYPE (CUT/FORMED LEAD)

The following lead configurations are available. When ordering, please indicate the type of lead configurations by using the appropriate supplement code, such as C3, FC, MC or RC in the product part number.

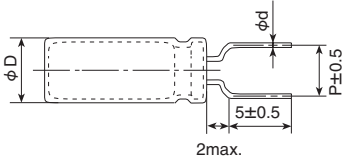
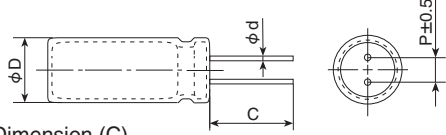
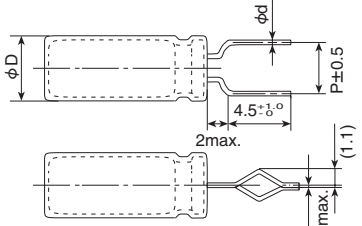
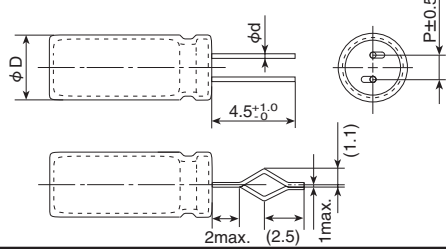
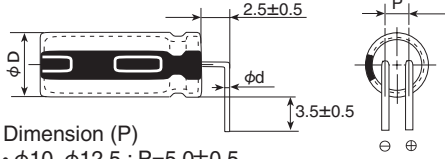
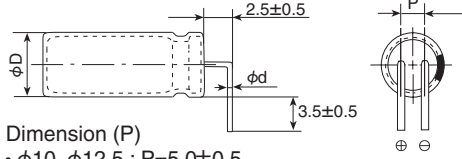
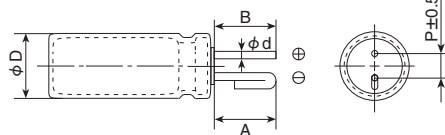
Terminal type	Size	Terminal type	Size												
<p>●Lead code : FC (Forming Cut type)</p>  <p style="text-align: center;">$\phi D=5$ to 8</p>	$\phi D=5$ to 8	<p>●Lead code : C3 (Cutting type)</p>  <p>Dimension (C)</p> <ul style="list-style-type: none"> • $\phi D= 4$ to 8: C3: 3.5 ± 0.5(Second standard C5: 5.0 ± 0.5) • $\phi D=10$ to 18: C3: 3.5 ± 0.5(Second standard C5: 5.0 ± 1.0) <p style="text-align: center;">$\phi D=4$ to 18</p>	$\phi D=4$ to 18												
<p>●Lead code : FM (Snap-in type)</p>  <p style="text-align: center;">$\phi D=5$ to 8</p>	$\phi D=5$ to 8	<p>●Lead code : MC (Snap-in type)</p>  <p style="text-align: center;">$\phi D=10$ to 18</p>	$\phi D=10$ to 18												
<p>●Lead code : BC (Horizontal type)*3</p>  <p>Dimension (P)</p> <ul style="list-style-type: none"> • $\phi 10, \phi 12.5$: $P=5.0\pm 0.5$ • $\phi 14.5, \phi 16, \phi 18$: $P=7.5\pm 0.5$ <p style="text-align: center;">$\phi D=10$ to 18</p>	$\phi D=10$ to 18	<p>●Lead code : BD (Horizontal type)*3</p>  <p>Dimension (P)</p> <ul style="list-style-type: none"> • $\phi 10, \phi 12.5$: $P=5.0\pm 0.5$ • $\phi 14.5, \phi 16, \phi 18$: $P=7.5\pm 0.5$ <p style="text-align: center;">$\phi D=10$ to 18</p>	$\phi D=10$ to 18												
<p>●Lead code : IJ (Forming Cut type)</p>  <p>Dimension</p> <table border="1" style="margin-left: auto; margin-right: auto; border-collapse: collapse;"> <thead> <tr> <th>ϕD</th> <th>A · B</th> <th>ϕd</th> <th>P</th> </tr> </thead> <tbody> <tr> <td>10 to 12.5</td> <td>3.2 ± 0.5</td> <td>0.6</td> <td>5.0 ± 0.5</td> </tr> <tr> <td>14.5 to 18</td> <td>3.2 ± 0.5</td> <td>0.8</td> <td>7.5 ± 0.5</td> </tr> </tbody> </table> <p style="text-align: center;">$\phi D=10$ to 18</p>	ϕD	A · B	ϕd	P	10 to 12.5	3.2 ± 0.5	0.6	5.0 ± 0.5	14.5 to 18	3.2 ± 0.5	0.8	7.5 ± 0.5	$\phi D=10$ to 18	<p>*1 Please consult with us about other terminal forming.</p> <p>*2 Please refer to dimensions of each series for gas escape end seal style.</p> <p>*3 Conventionally, lead forming code is used in common by (BC) for two type of the lead bent directions. We added lead forming code (BD) newly and clarified the lead bent directions. Please place an order after the choice for an appropriate lead forming code depending on condition of use.</p>	
ϕD	A · B	ϕd	P												
10 to 12.5	3.2 ± 0.5	0.6	5.0 ± 0.5												
14.5 to 18	3.2 ± 0.5	0.8	7.5 ± 0.5												

◆ DIMENSION (P) [mm]

Size	Lead forming	Cutting type		Snap-in type	
		FC	C3(C5)	FM	MC
$\phi 4$	—	—	1.5	—	—
$\phi 5$	—	5.0	2.0	5.0	—
$\phi 6.3$	—	5.0	2.5	5.0	—
$\phi 8$	5L	5.0	2.5	5.0	—
	7L min.	5.0	3.5	5.0	—
$\phi 10$	—	—	5.0	—	5.0
$\phi 12.5$	—	—	5.0	—	5.0
$\phi 14.5$	—	—	7.5	—	7.5
$\phi 16$	—	—	7.5	—	7.5
$\phi 18$	—	—	7.5	—	7.5

*4 Please refer to dimensions of each series for lead-wire diameter (ϕd).



PACKAGING

MINIMUM ORDER QUANTITY

Please order by minimum order quantity.

◆SURFACE MOUNT

●Vertical



Series	Size code	Quantity (pcs)	
		Taping	Tray (pcs/box)
Alchip™ MVA/MVE/MZR MZJ/MZA/MVY MZJ/MZA/MVY MZJ/MZA/MVY MLA/MLF/MLE MLK/MVL/MVJ MVH/MHL/MHB MHJ/MHK/MKB MV-BP/MVK-BP	D55, D60, D61	2,000	—
	D73	1,500	—
	E40, E46, E55, E60, E61, E73	1,000	—
	F35, F45, F46, F55, F60, F61, F73	1,000	—
	F80, H80	900	—
	F90	800	—
	FA0	750	—
	H63, H70	1,000	—
	HA0	500	—
	HC0	400	—
	J80, JA0	500	—
	JC0	400	—
	KE0	250*1	600
NPCAP™ PMA PXJ/PXG/PXK PXS/PXF/PXE PXA/PXD/PXH	KG5	200*1	600
	LH0	175*1	400
	LN0	125*1	400
	MH0	150*1	300
	MN0	100*1	300
Hybrid HXC/HXD/HXA HXB			

*1 : Changed the packing quantity. (Size Code : KE0 to MN0)

◆RADIAL



Size	Quantity (pcs)		
	Bagged *2	Taping	Tray Cut type (C3, C5)
φ 4	200	2,000	—
φ 5	200	2,000	—
φ 6.3	200	2,000	—
φ 8	200	1,000	—
φ 10	Height ≤25mm	200(100)*3	1,500
	Height 30mm	200	750
φ 12.5	Height ≤25mm	100	1,500
	Height 30mm		750
φ 14.5	50	250	500
φ 16	50	250	500
φ 18	50	250	500

*2 Standard bagged quantity.

*3 Minimum order quantity for PSJ/PSG(11.5L max.)/PSK/PSF/PSE/PSC/PSA/PS series.

◆SNAP-IN



200 pieces

AVAILABLE TERMINALS FOR SNAP-IN AND SCREW-MOUNT TYPE

- We can make the following terminal type on custom design.
- There is a restriction for specification of product, please consult with us when the product is required.
- Please consult with us about terminal type other than those following listed.

Snap-in type

[mm]

<p>Terminal, Dummy code : VNN</p> <p style="text-align: right; background-color: #0070C0; color: white; padding: 2px;">D=φ22 to φ35</p> <p>PC board pin-out (View from Solder side)</p>	<p>Terminal, Dummy code : LIN</p> <p style="text-align: right; background-color: #0070C0; color: white; padding: 2px;">D=φ30 to φ40</p> <p>PC board pin-out (View from Solder side)</p>
<p>Terminal, Dummy code : VEN</p> <p style="text-align: right; background-color: #0070C0; color: white; padding: 2px;">D=φ30, φ35</p> <p>PC board pin-out (View from Solder side)</p>	<p>Terminal, Dummy code : VRD</p> <p style="text-align: right; background-color: #0070C0; color: white; padding: 2px;">D=φ35, φ40</p> <p>PC board pin-out (View from Solder side)</p> <p>B : Positive, A, C : Dummy</p>
<p>Terminal, Dummy code : VND</p> <p style="text-align: right; background-color: #0070C0; color: white; padding: 2px;">D=φ35, φ40</p> <p>PC board pin-out (View from Solder side)</p> <p>B : Positive, A, C : Dummy</p>	<p>Terminal, Dummy code : LIS</p> <p style="text-align: right; background-color: #0070C0; color: white; padding: 2px;">D=φ50</p> <p>PC board pin-out (View from Solder side)</p> <p>A : Dummy</p>
<p>Horizontal mounting</p> <p style="text-align: right; background-color: #0070C0; color: white; padding: 2px;">D=φ20×30 to 50L, φ22×30 to 50L</p> <p>Terminal, Dummy code : LCN</p> <p>PC board pin-out (View from Solder side)</p>	

*1 Negative terminal : Mesh marking

*2 Use the dummy terminals for mechanical support only.

The dummy terminals must not be connected to any circuit trace on PC board, be sure to electrically isolate from the negative and the positive terminals.

Screw-mount type

[mm]

<p>Stud mounting type</p> <p>PC board pin-out (View from Solder side)</p>	<p style="text-align: right; background-color: #0070C0; color: white; padding: 2px;">D=φ63.5 to φ89</p> <p>Installation Recommendation plate thickness: 3.2mm</p> <p>Recommendation mounting hole: φ31±0.5</p> <p>Mounting screw and case are same potential as the cathode terminal. Please careful of isolation between chassis.</p>
---	---

Please consult with us about other size.



The following series are discontinued. Please use the replacements in the table.

◆CHIP TYPE REPLACEMENTS

Discontinued series	Characteristics	Replacements	Page
MV	85°C standard	MVA	92
MVK	105°C standard	MVE	94
MKA			
MVZ	Low impedance	MZA	100
MZD	Low impedance, Long life	MZE	106

◆LEAD TYPE REPLACEMENTS

Discontinued series	Characteristics	Replacements	Page
SM	85°C standard	SMG	149
SME			
KM	105°C standard	KMG	152
KMC			
KME			
USM			
SHA	95°C L=7mm	LXY/LXZ	180/177
SM-BP	85°C bi-polar	*	—
KM-BP	105°C bi-polar	*	—
SRC	85°C low profile	SRG	139
LXE	Low impedance	KY/LXV	172/182
LXJ			
SXE			
KMF(6.3 to 100V _{dc})			
LXF	Low impedance	LXY	180
KMY	Long life	KY	172
LXA	Long life	KY/LXY	172/180
SMH	85°C large radial	SMG/PAG	149/195
KMH	105°C large radial	KMG/PAG	152/195
GXD	High heat resistance	GXE	215
GHA	150°C high heat resistance	*	—
KMF(160 to 450V _{dc})	High ripple current	KXG	189
KMX	Long life		
KZA	For PC motherboard	*	—
LLA	85°C low leakage current	*	—

◆SCREW-MOUNT TERMINAL REPLACEMENTS

Discontinued series	Characteristics	Replacements	Page
LWY	105°C long life	LXA/LXR	318/322

* Please contact us.

Already been discontinued products are not listed in this catalog.



WORLD-WIDE MANUFACTURING LOCATIONS

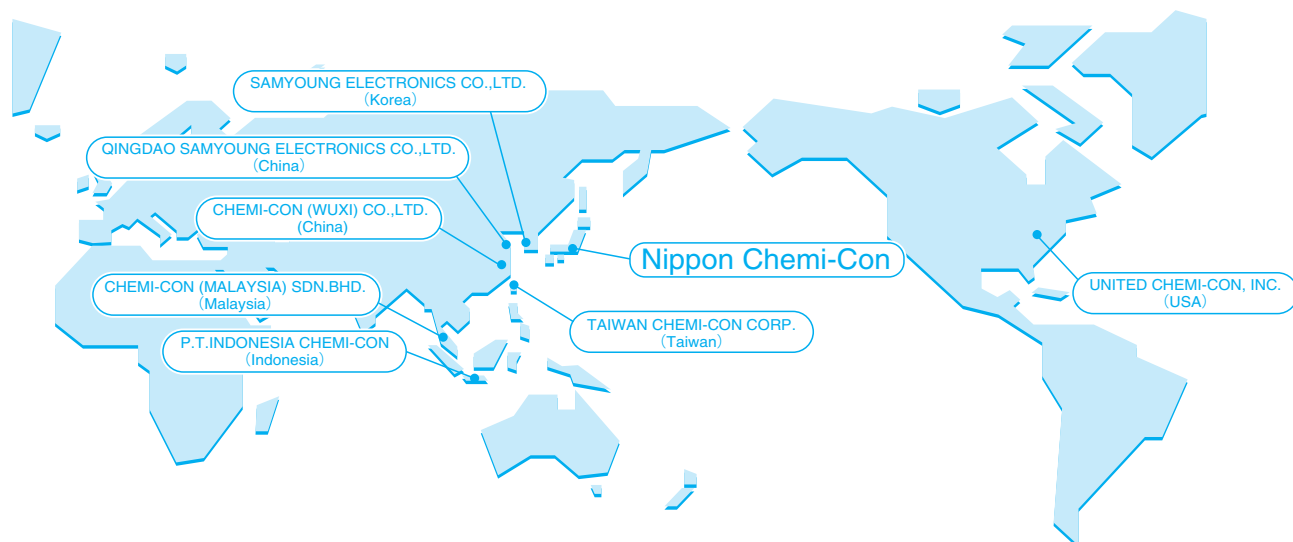

● AVAILABLE ITEMS BY MANUFACTURING LOCATIONS (Production in Japan is excluded)

Classification		Series	SAMYOUNG ELECTRONICS (Korea)	QINGDAO SAMYOUNG ELECTRONICS (China)	CHEMI-CON WUXI (China)	P.T.INDONESIA CHEMI-CON (Indonesia)	TAIWAN CHEMI-CON (Taiwan)	CHEMI-CON MALAYSIA (Malaysia)	UNITED CHEMI-CON (USA)
Conductive Polymer Electrolyte Type	SMD	PXE					●		
		PXF					●		
	Radial lead	PSA					●		
		PSC					●		
		PSE					●		
		PSF				●			
SMD	MVA/MVE	●	●	●	●				
	MVY	●		●	●				
	MZA				●				
	MVH			●					
Radial lead Low profile	SRE				●				
	SRA/KMA				●				
	SRG				●				
Radial lead General purpose	SMG/KMG	●	●	●	●	●			
	SMQ/KMQ			●	●	●			
Radial lead Bi-polar	SME-BP	●	●		●				
	KME-BP	●	●		●				
Radial lead Low impedance, High ripple current	LXZ			●	●				
	LXV			●	●		●		
	KY	●	●	●	●	●	●		
	KYA	●	●	●	●	●	●		
	KYB			●	●	●	●		
	KZE	●	●	●	●	●	●		
	KZH			●	●	●	●		
	KZM			●	●	●	●		
	KZN			●	●	●	●		
	KXG			●	●	●	●		
Radial lead High temperature Long life	KXJ			●	●	●	●		
	PAG			●	●	●	●		
Radial lead Snap-in	GPA			●	●				
	GXE			●	●				
Screw-mount terminal	LE				●				
	SMQ/KMQ						●		
	KMR						●		
	SMM/KMM						●		
	KMS						●		
	LXS/LXQ						●		
	LXM						●		
	CHA						●		
KMV						●			
Screw-mount terminal	KMH			●				●	
	RWE			●				●	
	RWF			●				●	
	RWY			●				●	
	RWL			●				●	
	LXA			●				●	
	U37F/U37L/U37X							●	
UTOR							●		

*1 Please be sure to contact us before ordering as our product range is continuously improved and the product you require may have been superseded.
 *2 Refer to our web site for factory address.

Conductive Polymer Aluminum Solid Capacitors

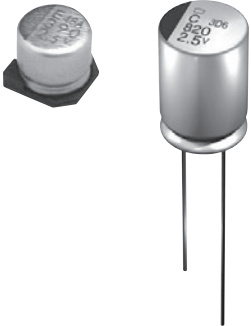



PRECAUTIONS AND GUIDELINES (Conductive Polymer)

The NPCAP™ is a Conductive Polymer Solid Aluminum Capacitor that uses highly conductive polymer electrolytic material. Please read the following in order to get the most out of your NPCAP™ capacitor.

For Conductive Polymer Hybrid Aluminum Electrolytic Capacitors, see Precautions and Guidelines (Conductive Polymer Hybrid).

For Aluminum Electrolytic Capacitors, see Precautions and Guidelines (Aluminum Electrolytic Capacitors).

1 | Designing Device Circuits

1) Types of Circuits Where NPCAP™ Capacitors are Not to be Used

The leakage current in conductive polymer solid aluminum capacitors (hereafter called capacitors) may vary depending on thermal stresses during soldering. Avoid the use of capacitors in the following types of circuits:

- ① High-impedance circuits that are to sustain voltages.
- ② Coupling circuits
- ③ Time constant circuits

Because the capacitance varies depending on the environment the capacitors are used in, there is a possibility that the capacitor can affect a time constant circuit where sensitivity to variation in capacitance is required.

- ④ Other circuits that are significantly affected by leakage current

2) Circuit Design

Verify the following before designing the circuit:

- ① The electrical characteristics of the capacitor will vary depending on differences in temperature and frequency. You had better design after verifying the scope of these factors.
- ② When connecting two or more capacitors in parallel, ensure that the design takes current balancing into account.
- ③ When two or more capacitors are connected in series, variability in applied voltage may cause over-voltage conditions. Contact Nippon Chemi-Con before using capacitors connected in series.
- ④ Avoid putting heat generating parts either around the capacitor or on the reverse of the circuit board.

3) Use in High Reliable and Critical Applications

Consult with Nippon Chemi-Con before using these capacitors in applications involving human life: Aviation/aerospace equipment, Nuclear power equipment, Medical equipment and Automotive equipment, or in applications where capacitor failure could have a major impact.

4) Polarity

The NPCAP™ is a polarized solid aluminum electrolytic capacitor. Do not apply either reverse voltages or AC voltages to the polarized capacitors, using reversed polarity may cause a short circuit. Refer to the catalog, product specifications or capacitor body to confirm the polarity prior to use.

5) Operating Voltage

Do not apply a greater than rated voltage, if a voltage greater than the rated voltage is suddenly applied the leakage current increases causing shorting. The peak voltage of superimposed AC voltages (ripple voltages) on DC voltages must not exceed the full rated voltage. Capacitors do not require voltage derating within the category temperature. While there are specifications for surge voltages exceeding the rated voltage, usage conditions apply, and continued operation for extended periods of time under such conditions cannot be guaranteed.

6) Ripple Current

Do not apply currents in excess of the rated ripple current. The superimposition of a large ripple current increases the rate of heating within the capacitor. When excessive ripple current is imposed the internal temperature increases which can shorten life and shorting may occur.

7) Operating Temperature

Use within the stated category temperature range, if used outside this range, characteristics can deteriorate potentially lead-

ing to problems.

8) Charging and Discharging the Capacitor

Do not use the NPCAP™ capacitor in circuits where the capacitor is repetitively charged and discharged rapidly. Repetitively charging and discharging the capacitor rapidly may reduce the capacitance or may cause damage due to internal heating. Use of a protective circuit to ensure reliability is recommended when rush currents exceed 20A.

9) Leakage current

The leakage current may increase when the capacitors are subjected to the conditions below. After that, however, the leakage current will gradually decrease by self-healing action of the dielectric oxide layer when the capacitors are applied with a voltage less than the rated voltage within the Category Temperature range. As the voltage is closer to the rated voltage and the temperature is closer to the upper limit of Category Temperature range, the leakage current decreases faster.

The leakage current will increase by the following factors,

- ① Soldering
- ② Testing of high temperature exposure with no voltage applied, high temperature/humidity storage, temperature cycles, etc.

10) Failures and Service Life

Based on the JIS C 5003 Standard, the failure rate for NPCAP™ capacitors (with a 60% reliability standard) is as follows:

0.5%/1,000 hours (applied the rate voltage at the upper limit of Category Temperature range)

(1) Failure Modes

- ① The principal failure mode is wear-out failure, that is, capacitance decreases and ESR increases, and eventually the capacitors become open circuit failure. In addition, short circuit failure may happen with over-voltage and excessive current applied to the capacitors.
- ② The failure rate would be reduced by reducing ambient temperatures, ripple current and applying voltage.
- ③ If the short-circuited capacitor, which may be caused by over-voltages higher than the rated voltage or other conditions, has a large amount of current passed through, the aluminum can of the capacitor / resin molded case bulges and might be expelled with odor gas emitted.
- ④ The product contains flammable materials. If the short causes a spark it may ignite.

Please be careful when installing the product, its position and the layout design.

- Increase safety by using in conjunction with a protective circuit or protective equipment.
- Install measures such as redundant circuits so that the failure of a part of the equipment will not cause unstable operation.

(2) Service Life

- ① SMD (Resin-Molded chip type) , the service life depends on the thermal degradation of conductive polymer or sealing resin.
- ② SMD (Chip type) and radial lead type use rubber as the sealing material, so the service life depends on the thermal integrity of this rubber.

When long life performance is required in actual use, please use the capacitor at lower temperature within the category temperature.



PRECAUTIONS AND GUIDELINES (Conductive Polymer)

11) Capacitor Insulation

Insulation of the capacitor's case is not guaranteed. Ensure electrical insulation between the capacitor case, negative electrode, positive electrode and circuit pattern.

12) Capacitor Usage Environment

Do not use/expose capacitors to the following conditions.

- ① Oil, water, salty water, take care to avoid storage in damp locations.
- ② Direct sunlight
- ③ Toxic gases such as hydrogen, sulfide, sulfuric acids, nitrous acids, chlorine and chlorine compounds, bromine and bromine compounds, ammonia, etc.
- ④ Ozone, ultraviolet rays and radiation.
- ⑤ Severe vibration or mechanical shock conditions beyond the limits advised in the product specification section of the catalog.

The standard vibration condition is applicable to JIS C 5101-4.

13) Capacitor mounting

- ① For the surface mount capacitor, design the solder land on the PC board in accordance with the catalog or the product specification.
- ② For radial capacitors, design the terminal holes on the PC board to fit the terminal dimension of the capacitor.
- ③ Do not pass any circuit traces beneath the seal side of a capacitor. The trace must pass 1 to 2mm to the side of the capacitor.
- ④ Do not pass any via holes underneath a capacitor on double sided PC board
- ⑤ In designing double-sided PC boards, do not locate any copper trace under the seal side of a capacitor

2 | Installing Capacitors

1) Installing

- ① Do not reuse capacitors already assembled in equipment that have been exposed to power.
- ② The capacitor may have self charge. If this happens, discharge the capacitor through a resistor of approximately 1k before use.
- ③ If capacitors are stored at a temperature of 35°C or more and more than 75%RH, the leakage current may increase. This may also occur if the capacitors are stored for a longer period than the period which is specified in the catalog or the product specification. In this case, they can be reformed by the voltage treatment through a resistor of approximately 1k.
- ④ Verify the rated capacitance and voltage of the capacitors when installing.
- ⑤ Verify the polarity of the capacitors.
- ⑥ Do not use the capacitors if they have been dropped on the floor.
- ⑦ Do not deform the case of the capacitors.
- ⑧ Verify that the lead spacing of the capacitor fits the hole spacing in the PC board before installing the capacitors.
- ⑨ Do not apply any mechanical force in excess of the limits prescribed in the catalog or the product specification of the capacitors. Avoid subjecting the capacitor to strong forces, as this may break the electrode terminals, bend or deform the capacitor, or damage the packaging, and may also cause short/open circuits, increased leakage current, or damage the appearance. Also, note the capacitors may be damaged by mechanical shocks caused by cut the lead wire, the vacuum/insertion head, component checker or centering operation of an automatic mounting or insertion machine.

2) Heat Resistance during Soldering

Ensure that the soldering conditions meet the specifications recommended by Nippon Chemi-Con. Note that the leakage current may increase or capacitance may decrease due to thermal stresses that occur during soldering, etc. Furthermore, the

leakage current which rose gradually decreases, when voltage is applied at below the category upper limit temperature. Additionally the self repairing action is faster when voltage near the rated voltage rather than at a higher voltage is applied at below the category's upper temperature limit.

① Verify the following before using a soldering iron:

- That the soldering conditions (temperature and time) are within the ranges specified in the catalog or product specifications.
- That the tip of the soldering iron does not come into contact with the capacitor itself.

② Verify the following when flow soldering:

- Do not dip the body of a capacitor into the solder bath only dip the terminals in. The soldering must be done on the reverse side of PC board.
- Soldering conditions (preheat, solder temperature and dipping time) should be within the limits prescribed in the catalog or the product specifications.
- Do not apply flux to any part of capacitors other than their terminals.
- Make sure the capacitors do not come into contact with any other components while soldering.
- Flow soldering must not be used for the SMD(Chip type) capacitors.

③ Verify the following when reflow soldering:

- Soldering conditions (preheat, solder temperature and soldering time) should be within the limits prescribed in the catalogs or the product specification.
- The heat level should be appropriate. (Note that the thermal stress on the capacitor varies depending on the type and position of the heater in the reflow oven, and the color and material of the capacitor.)
- Please consult us about Vapor phase soldering (VPS).
- Except for the surface mount type, reflow soldering must not be used for the capacitors.

④ Do not reuse a capacitor that has already been soldered to PC board and then removed. When using a new capacitor in the same location, remove the flux, etc. first, and then use a soldering iron to solder on the new capacitor in accordance with the specifications.

3) Handling After Soldering

Do not apply any mechanical stress to the capacitor after soldering onto the PC board.

- ① Do not lean or twist the body of the capacitor after soldering the capacitors onto the PC board.
- ② Do not use the capacitors for lifting or carrying the assembly board.
- ③ Do not hit or poke the capacitor after soldering to PC board. When stacking the assembly board, be careful that other components do not touch the aluminum electrolytic capacitors.
- ④ Do not drop the assembled board.

4) Cleaning PC boards

Do not wash PMA series by using any cleaning agents.

- ① Do not wash capacitors by using the following cleaning agents. Solvent resistant capacitors are only suitable for washing using the cleaning conditions prescribed in the catalog or the product specification. In particular, ultrasonic cleaning will accelerate damage to capacitors.
 - Halogenated solvents; cause capacitors to fail due to corrosion.
 - Alkali system solvents; corrode (dissolve) an aluminum case.
 - Petroleum system solvents; cause the rubber seal material to deteriorate.
 - Xylene; causes the rubber seal material to deteriorate.
 - Acetone; erases the markings.
- ② Verify the following points when washing capacitors.
 - CFC alternatives or the other cleaners above; please consult with us.



PRECAUTIONS AND GUIDELINES (Conductive Polymer)

- Monitor conductivity, pH, specific gravity and the water content of cleaning agents. Contamination adversely affects these characteristics.
- Be sure not to expose the capacitors under solvent rich conditions or keep capacitors inside a closed container. In addition, please dry the solvent sufficiently on the PC board and the capacitor with an air knife (temperature should be less than the maximum rated category temperature of the capacitor) for 10 minutes. Aluminum electrolytic capacitors can be characteristically and catastrophically damaged by halogen ions, particularly by chlorine ions, though the degree of the damage mainly depends upon the characteristics of the electrolyte and rubber seal material. When halogen ions come into contact with the capacitors, the foil corrodes when a voltage is applied. This corrosion causes an extremely high leakage current which results venting and an open circuit.

If the new types of cleaning agents mentioned below are used, the following are recommended as cleaning conditions for some of new cleaning agents.

-Higher alcohol cleaning agents

Pine Alpha ST-100S (Arakawa Chemical)

Clean Through 750 H, 750K, 750L, and 710M (Kao)

Technocare FRW-14 through 17 (Momentive performance material)

Cleaning Conditions:

Using these cleaning agents, capacitors are capable of withstanding immersion or ultrasonic cleaning for 10 minutes at a maximum liquid temperature of 60°C. Find optimum condition for washing, rinsing, and drying. Be sure not to rub the marking off the capacitor which can be caused by contact with other components or the PC board. Note that shower cleaning adversely affects the markings on the sleeve.

-Non-Halogenated Solvent Cleaning

AK225AES (Asahi Glass)

Cleaning Conditions:

Immersion, ultrasonic or vapor cleaning for 5 minutes. However, from an environmental point of view, these types of solvent will be banned in near future. We would recommend not using them if at all possible.

-Isopropyl Alcohol (IPA)

IPA (Isopropyl Alcohol) is one of the most acceptable cleaning agents; it is necessary to maintain a flux content in the cleaning liquid at a maximum limit of 2 Wt.%.

5) Precautions for using adhesives and coating materials

- ① Do not use any adhesive and coating materials containing halogenated solvent.
- ② Verify the following before using adhesive and coating material.
 - Remove flux and dust left over between the rubber seal and the PC board before applying adhesive or coating materials to the capacitor.
 - Dry and remove any residual cleaning agents before applying adhesive and coating materials to the capacitors. Do not cover over the whole surface of the rubber seal with the adhesive or coating materials.
 - For permissible heat conditions for curing adhesives or coating materials, please consult with us.
 - Covering over the whole surface of the capacitor rubber seal with resin may result in a hazardous condition because the inside pressure cannot be completely released. Also, a large amount of halogen ions in resins will cause the capacitors to fail because the halogen ions penetrate into the rubber seal and the inside of the capacitor.
 - Some coating materials, it cannot be implemented to the capacitor. Please note change on the surface might be caused ac-

ording to the kind of solvents used for mounting adhesives and coating agents.

6) Fumigation

In many cases when exporting or importing electronic devices, such as capacitors, wooden packaging is used. In order to control insects it may become necessary to fumigate the shipment. Precautions during "Fumigation" using halogenated chemical such as Methyl Bromide must be taken. Halogen gas can penetrate packaging materials such as cardboard boxes and vinyl bags. Penetration of the halogenated gas can cause corrosion of Electrolytic capacitors. Nippon Chemi-Con gives consideration to the packaging materials not to require the Fumigation. Verify whether the assembled PC board, products and capacitors themselves are subjected to Fumigation during their transportation or not.

3) The Operation of Devices

- 1) Do not touch the capacitor terminals directly.
- 2) Do not short-circuit the terminal of a capacitor by letting it come into contact with any conductive object. Also, do not spill electric-conductive liquid such as acid or alkaline solution over the capacitor.
- 3) Do not use capacitors in circumstances where they would be subject to exposure to the following materials
 - Oil, water, salty water or damp location.
 - Direct sunlight.
 - Ozone, ultraviolet rays or radiation.
 - Toxic gases such as hydrogen sulfide, sulfurous acid, nitrous acid, chlorine or its compounds, and ammonium.
 - Severe vibration or mechanical shock conditions beyond the limits prescribed in the catalog or product specification. The standard vibration condition is applicable to JIS C 5101-4.

4) Maintenance Inspection

- 1) Make periodic inspections of capacitors that have been used in industrial applications. Before inspection, turn off the power supply and carefully discharge the electricity in the capacitors. Verify the polarity when measuring the capacitors with a volt-ohm meter. Do not apply any mechanical stress to the terminals of the capacitors.
- 2) The following items should be checked during the periodic inspections.
 - ① Significant damage in appearance
 - ② Electrical characteristics: leakage current, capacitance, $\tan \delta$ and other characteristics prescribed in the catalog or product specification.

We recommend replacing the capacitors if the parts are out of specification.

5) Contingencies

- 1) If gas has vented from the capacitor during use, there is a short circuit and burning, or the capacitor discharges an odor or smoke, turn off the main power supply to the equipment or unplug the power cord.
- 2) If there is a problem with the capacitor or a fire breaks out, the capacitor may produce a burning gas or reactive gas from the outer resin, etc. If this happens, keep your hands and face away from the gas. If vented gas is inhaled or comes into contact with your eyes, flush your eyes immediately with water and/or gargle. If vented gas comes into contact with the skin, wash the affected area thoroughly with soap and water.

6) Storage

We recommend the following conditions for storage.



PRECAUTIONS AND GUIDELINES (Conductive Polymer)

- 1) Store capacitors in a cool, dry place. Store at a temperature between 5 and 35°C, with a humidity of 75% or less. (table-1 Maximum storage term)

	Before the bag is opened	After the bag is opened
SMD (Resin-Molded chip type)	Within 2 years after manufacturing	Within 7 days after the bag is opened
SMD (Chip type)	Within 3 years after manufacturing	Within 6 months after the bag is opened
Radial	Within 3 years after manufacturing	—

SMD products are sealed in a special laminated aluminum bag. Use all capacitors once the bag is opened. Return unused capacitors to the bag, and seal it with a zipper. Please refer to (Table -1 maximum storage term) for storage conditions. Be sure to follow our recommendations for reflow soldering.

- 2) Store the capacitors in a location free from direct contact with water, salt water, and oil.
- 3) Store in a location where the capacitor is not exposed to toxic gas, such as hydrogen sulfide, sulfurous acid, nitrous acid, chlorine or chlorine compounds, bromine or other halogen gases, methyl bromide or other halogen compounds, ammonia, or similar.
- 4) Store in a location where the capacitor is not exposed to ozone, ultraviolet radiation, or other radiation.
- 5) It is recommended to store capacitors in their original packaging wherever possible.
- 6) The JEDEC J-STD-020 standard does not apply.

7 Disposal

Please consult with a local industrial waste disposal specialist when disposing of aluminum electrolytic capacitors.

8 About AEC-Q200

The Automotive Electronics Council (AEC) was originally established by major American automotive related manufactures. Today, the committees are composed of representatives from the sustaining Members of manufacturing companies in automotive electrical components. It has standardized the criteria for "stress test qualification" and "reliability tests" for electronic components.

AEC-Q200 is the reliability test standard for approval of passive components in Automotive applications. It specifies the test type, parameters and quantity, etc. for each component. The criteria of the reliability tests such as for our main products, "Aluminum Electrolytic Capacitors" are described in this standard. Pursuant to the customer's specific testing requirements, Chemi-Con submits the test results according to AEC-Q200 for Aluminum Electrolytic Capacitors used in automotive applications on request. An electronic component manufacturer cannot simply claim that their product is "AEC-Q200 Qualified". It can be claimed "Compliant", "Capable", "Available", etc., however each component must be tested per each users "Qualification Test Plan" in order to claim AEC-Q200 status. Please contact us for more information.

9 Regarding compliance for EU REACH Regulation

- 1) According to the content of REACH handbook (Guidance on requirements for substances in articles which is published on May 2008), our electronic components are "articles without any intended release". Therefore they are not applicable for "Registration" for EU REACH Regulation Article 7 (1).

Reference: Electrolytic Condenser Investigation Society
"Study of REACH Regulation in EU about Electrolytic Capacitor"
(publicized on 13 March 2008)

- 2) Nippon Chemi-Con develops the products without substance of very high concern(SVHC).

10 Catalogs

Specifications in the catalogs are subject to change without notice. Test data shown in the catalogs are not assured as the whole performance values, but typical values. For more details, refer to JEITA RCR-2367C (March 2006)

with the title of "Safety Application Guide for fixed aluminum electrolytic capacitors for use in electronic equipment".



RECOMMENDED SOLDERING CONDITIONS FOR NPCAP™

◆ SURFACE MOUNT TYPE

The following conditions are recommended for air or infrared reflow soldering PMA/PXJ/PXG/PXK/PXS/PXF/PXE/PXA/PXD/PXH series onto a glass epoxy circuit board of 90×50×0.8mm (with resist) by cream solder. The temperatures shown are the surface temperature values on the top of the can and temperature of capacitor terminal.

Reflow should be performed twice or less.

Please ensure that the capacitor became cold enough to the room temperature (5 to 35°C) before the second reflow.

● Recommended soldering heat conditions

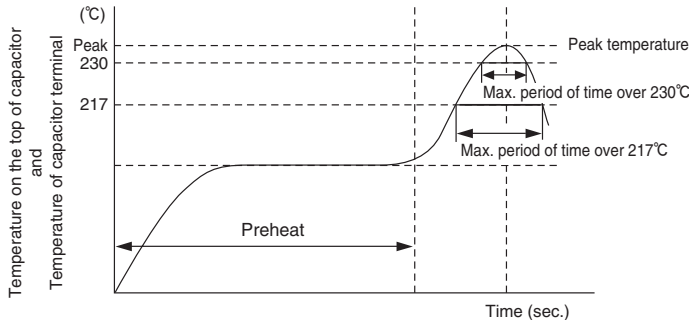

Series	Voltage range (V _{dc})	Preheat	Time maintained above 217°C	Time maintained above 230°C	Peak temp.	Reflow number
PMA	16 to 25V	150 to 180°C 120 sec. max.	50 sec. max.	40 sec. max.	260°C max.	1-cycle only
			40 sec. max.	30 sec. max.		2-cycle allowed
PXJ/PXG/ PXK/PXS/ PXF/PXE/ PXA/PXD/ PXH	2.5 to 16V	150 to 180°C 120 sec. max.	50 sec. max.	40 sec. max.	260°C max.	1-cycle only
			40 sec. max.	30 sec. max.	250°C max.	2-cycle allowed
	20 to 25V		50 sec. max.	40 sec. max.	250°C max.	1-cycle only
			40 sec. max.	30 sec. max.		2-cycle allowed

Note : Resin-Molded chip type have capability to withstand dip or flow soldering (Peak temperature:260°C) . Please consult us for details.

● Recommended Solder Land on PC Board

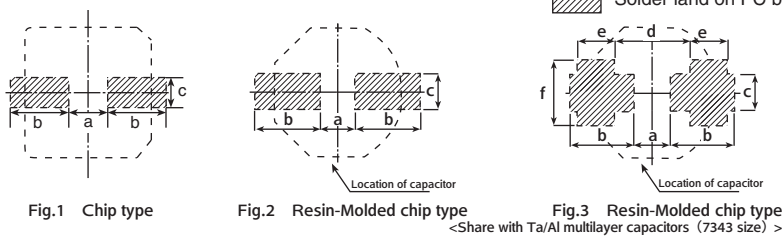

Size code	a	b	c	d	e	f	Fig.
D55	1.0	2.6	1.6	-	-	-	1
E40, E46, E60, E61	1.4	3.0	1.6	-	-	-	1
F35	1.9	3.5	2.0	-	-	-	2
	1.9	3.5	2.0	4.0	2.0	3.0	3
F45, F46, F55, F60 F61, F80, FA0	1.9	3.5	1.6	-	-	-	1
H70, H80, HA0, HC0	3.1	4.2	2.2	-	-	-	1
J80, JA0, JC0	4.5	4.4	2.2	-	-	-	1

◆ RADIAL LEAD TYPE

● Recommended soldering heat conditions

Preheat : 150°C 120 seconds max.

Flow soldering : 260±5°C max. 10+1 seconds max.

◆ PRECAUTIONS FOR USERS

Soldering method

SMD (Chip type) have no capability to with stand such dip or flow soldering as totally immersing components into a solder bath.

Reflow soldering

Reflow the capacitors within Recommended Reflow Soldering Conditions. Verify there is no temperature stress to the capacitors because the following differences might degrade capacitors electrically and mechanically. Please consult with us if other reflow conditions are employed.

1. Location of components : Temperature increases at the edge of PC board more than the center.
2. Population of PC board : The lower the component population is, the more temperature rises.
3. Material of PC board : A ceramic-made board needs more heat than a glass epoxy-made board. The heat increase may cause damage to the capacitors.
4. Thickness of PC board : A thicker board needs more heat than a thinner board. The heat may damage the capacitors.
5. Size of PC board : A larger board needs more heat than a smaller board. The heat may damage the capacitors.
6. Solder thickness
If very thin cream solder paste is to be used for SMD types, please consult with us.
7. Location of infrared ray lamps : IR reflow as well as hot plate reflow heats only on the reverse side of the PC board to lessen heat stress to the capacitors.
8. Case leakage current will increase (~mA) after the reflow process, the leakage current which rose gradually decreases when voltage is applied.
9. Please consult us about vapor phase soldering (VPS).

Rework of soldering

Use a soldering iron for rework. Do not exceed an iron tip temperature of 380±10°C and an exposure time of 3±0.5 seconds.

Mechanical stress

Do not grab the capacitors to lift the PC board and give stress to the capacitor. Avoid bending the PC board. This may damage the capacitors.

Cleaning assembly board

Immediately after solvent cleaning, remove residual solvent with an air knife for at least 10 minutes. If the solvent is insufficiently dry, the capacitors may corrode.

PMA series is not solvent resistant type.

Coating on assembly board

1. Before curing coating material, remove the cleaning solvents from the assembly board.
2. Before conformal coating, a chloride free pre-coat material is recommended to decrease the stress on the capacitors.

Molding with resin

Internal chemical reaction gradually produces gas in the capacitor; increasing internal pressure. If the end seal of the capacitor is completely covered by resin the gas will be unable to escape causing a potentially dangerous situation. The chlorine in resin will penetrate the end seal, reach the element, and damage of the capacitor.

Glue

The followings are requirements for glue.

1. A low curing temperature over a short period of time
2. Strong adhesion and heat resistance after curing
3. Long shelf life
4. No corrosion

Others

Refer to PRECAUTIONS AND GUIDELINES(Conductive Polymer).



Lifetime Estimation of Conductive Polymer Aluminum Solid Capacitors

Subject series : PXJ, PXG, PXK, PXS, PXF, PXE, PXA, PXD, PXH, PSJ, PSG, PSK, PSF, PSE, PSC, PSA, PS
Please consult us about lifetime equations for PMA series.

Conductive polymer aluminum solid capacitors are finite life electronic components like aluminum electrolytic capacitors. The lifetime is affected by ambient temperature, humidity, ripple current and surge voltage.

The lifetime of aluminum electrolytic capacitors is affected mainly by the loss of electrolyte as the result of the liquid electrolyte evaporating through the rubber seal materials, resulting in capacitance drop and $\tan \delta$ rise.

On the other hand, the lifetime of conductive polymer aluminum solid capacitors is affected mainly by oxidation degradation of the conductive polymer caused by osmose of oxygen or the thermal degradation of the conductive polymer by ambient temperature or self-heating, resulting in ESR rise and $\tan \delta$ rise.

The infiltration rate of the oxygen is depend on the temperature as the liquid electrolyte evaporation and the relationship follows the Arrhenius's Law, too. Similarly, thermal degradation of the conductive polymer by self-heating follows the Arrhenius's Law, too.

Therefore, the lifetime estimation has been using the theory of lifetime reducing by half at every 10°C rise of the ambient temperature.

1. Lifetime Estimation

Equation (1) can be used for estimating the lifetime of the conductive polymer aluminum solid capacitors based on the ambient temperature and the rise of internal temperature due to ripple current.

$$L_x = L_o \times 2^{\frac{T_o - T_x}{10}} \times 2^{\frac{-\Delta T}{10}} \dots\dots\dots(1)$$

- Lx : Estimation of actual lifetime (hour)
- Lo : Specified lifetime with the rated voltage at the upper limit of the category temperature (hour)
- To : Maximum category temperature (°C)
- Tx : Actual ambient temperature of the capacitor (°C)
(Note: Tx should be 40°C if the actual ambient temperature is below it)
- ΔT : Rise of internal temperature due to the rated ripple current (°C)

Longer lifetime is expected by lowering the ripple current and the ambient temperature.
Please consult us about lifetime equations for the series of the category temperature 125°C.
Subject series: PXD, PXH.

An approximate value of ripple current-caused ΔT can be calculated using Equation (2)

$$\Delta T = \Delta T_o \times \left(\frac{I_x}{I_o} \right)^2 \dots\dots\dots(2)$$

- ΔTo : Rise in internal temperature due to the rated ripple current (20°C)The product that the maximum category temperature is less than 105°C
- Ix : Operating ripple current (Arms) actually flowing in the capacitor
- Io : Rated ripple current (Arms), frequency compensated, at the upper limit of the category temperature range

Please contact us about the product that the maximum category temperature is more than 125°C.
To determine more accurate values of ΔT, they can be actually measured using a thermocouple.

2. Rated Ripple Current Frequency Multipliers

Self-heat rise is generated by the ripple current even though the conductive polymer aluminum solid capacitors have low ESR compared to liquid based electrolyte aluminum electrolytic capacitor. Longer lifetime is expected by lowering the ripple current and the ambient temperature. Table 1 shows Frequency Multipliers of Rated ripple current.

Table1. Frequency Multipliers

Frequency [Hz]	120	1k	10k	50k	100k to 500k
SMD type	0.05	0.30	0.55	0.70	1.00
Radial lead type	0.10	0.35	0.60	0.80	1.00

Conductive polymer aluminum solid capacitors have super low ESR characteristic in high-frequency range. On the whole, ESR in low-frequency range relatively rises. Therefore, they can use only small ripple current in low-frequency range.

Please ensure that excessive ripple current is not applied to the capacitors in all frequency range.

3. Restriction of calculated lifetime

The result calculated by the estimated lifetime formula, it is not guaranteed lifetime by Nippon Chemi-Con Corporation.

When designer calculate the lifetime of apparatus, please include an ample margin in consideration to the estimated lifetime of a capacitor.

When calculated lifetime result are over 15 years (131,400 hrs.) by using the estimated lifetime formula, please consider 15 years to be a maximum in considering that the sealing rubber characteristics vary during the lifetime.

If 15 years or more may be required as an expected lifetime, please consult us.

Product specifications in this catalog are subject to change without notice. Request our product specifications before purchase and/or use. Please use our products based on the information contained in this catalog and product specifications.

Return Group Chart



PART NUMBERING SYSTEM

Product code guide (Conductive polymer Surface mount type)

(Example : PXA series, 4V-150 μ F, ϕ 6.3 \times 5.7L)



Please refer to the following table

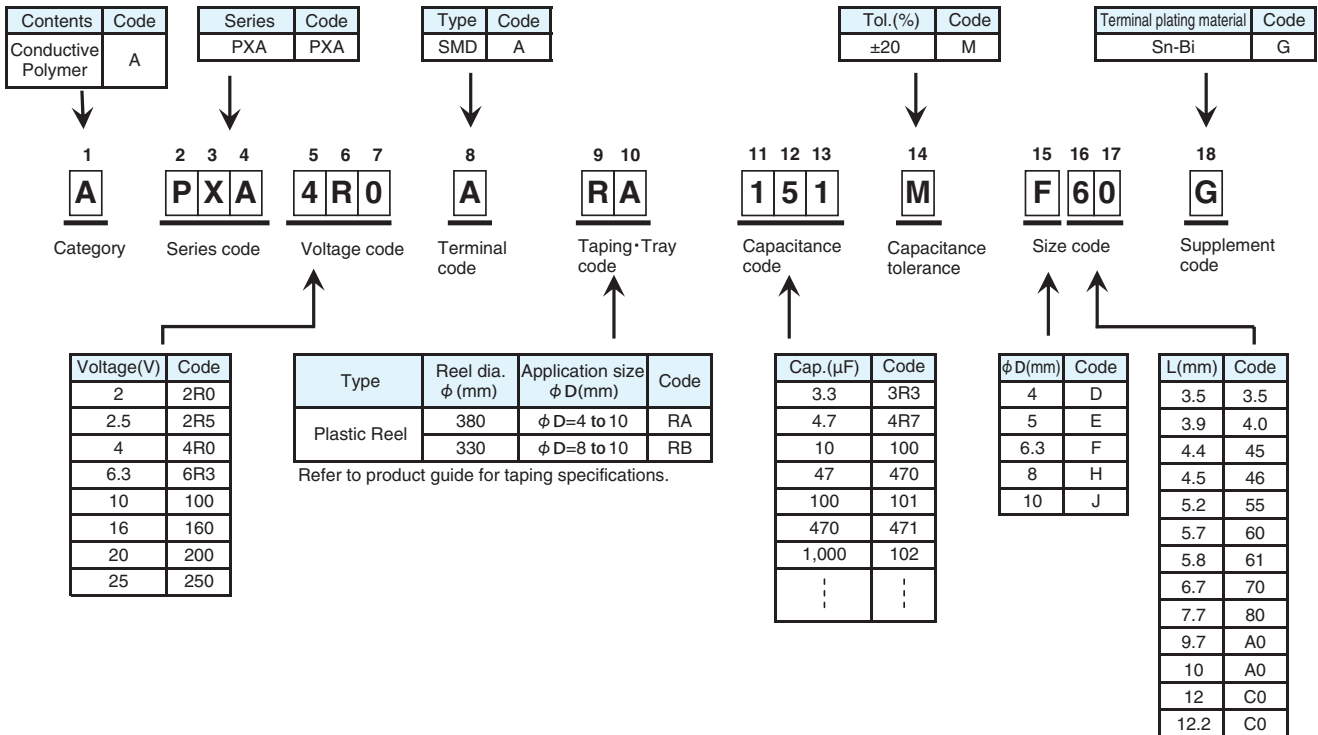

*Refer to the appendix (Part number) for codes not listed here.

Product code guide (Conductive polymer Radial lead type)

(Example : PSC series, 6.3V-470 μ F, ϕ 8 \times 8L, Long Lead with bulk)

Please refer to the following table

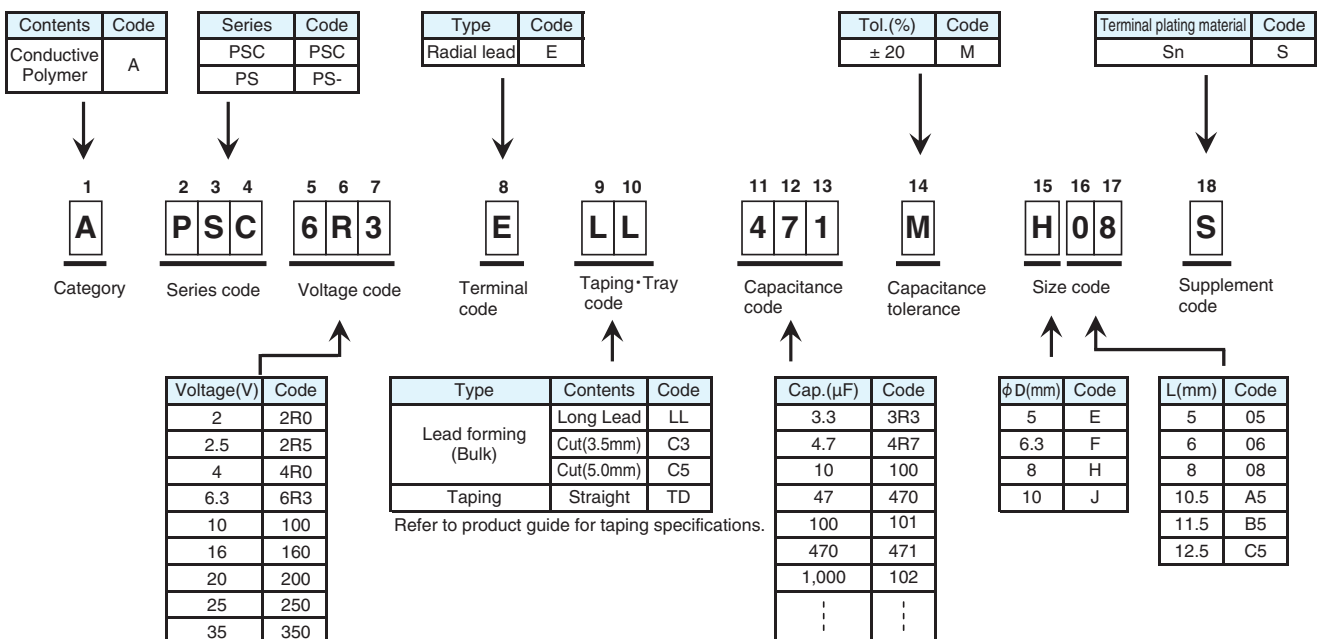

*Refer to the appendix (Part number) for codes not listed here.

Return Group Chart



CONDUCTIVE POLYMER ALUMINUM SOLID CAPACITORS

Surface Mount

NPCAP™-PXJ Series Upgrade!

- Super low ESR, impedance and high heat resistance have been obtained by using conductive polymer as electrolyte.
- Added case size Dia. 8.
- Rated voltage range : 2.5 to 25V_{dc}, Capacitance range : 56 to 1,200μF
- Case size range : φ 6.3×5.8L to φ 8×6.7L
- Suitable for DC-DC converters, voltage regulators and decoupling applications used on computer motherboards etc.
- Solvent resistant type (see PRECAUTIONS AND GUIDELINES)
- RoHS Compliant
- Halogen Free

PXJ
↑ Downsizing
PXG P32



◆ SPECIFICATIONS

Items	Characteristics										
Category											
Temperature Range	-55 to +105°C										
Rated Voltage Range	2.5 to 25V _{dc}										
Capacitance Tolerance	±20% (M) (at 20°C, 120Hz)										
Surge Voltage	Rated voltage × 1.15 (at 105°C)										
Leakage Current	Shall not exceed values shown in STANDARD RATINGS. (at 20°C after 2 minutes)										
Dissipation Factor (tan δ)	0.12 max. (at 20°C, 120Hz)										
Low Temperature Characteristics (Max. Impedance Ratio)	Z(-25°C)/Z(+20°C) ≤ 1.15 Z(-55°C)/Z(+20°C) ≤ 1.25 (at 100kHz)										
Endurance	The following specifications shall be satisfied when the capacitors are restored to 20°C after the rated voltage is applied for 15,000 hours at 105°C. <table border="1"> <tr><td>Appearance</td><td>No significant damage</td></tr> <tr><td>Capacitance change</td><td>≤ ±20% of the initial value</td></tr> <tr><td>D.F. (tan δ)</td><td>≤ 150% of the initial specified value</td></tr> <tr><td>ESR</td><td>≤ 150% of the initial specified value</td></tr> <tr><td>Leakage current</td><td>≤ The initial specified value</td></tr> </table>	Appearance	No significant damage	Capacitance change	≤ ±20% of the initial value	D.F. (tan δ)	≤ 150% of the initial specified value	ESR	≤ 150% of the initial specified value	Leakage current	≤ The initial specified value
Appearance	No significant damage										
Capacitance change	≤ ±20% of the initial value										
D.F. (tan δ)	≤ 150% of the initial specified value										
ESR	≤ 150% of the initial specified value										
Leakage current	≤ The initial specified value										
Bias Humidity	The following specifications shall be satisfied when the capacitors are restored to 20°C after subjecting them to the DC rated voltage at 60°C, 90 to 95% RH for 1,000 hours. <table border="1"> <tr><td>Appearance</td><td>No significant damage</td></tr> <tr><td>Capacitance change</td><td>≤ ±20% of the initial value</td></tr> <tr><td>D.F. (tan δ)</td><td>≤ 150% of the initial specified value</td></tr> <tr><td>ESR</td><td>≤ 150% of the initial specified value</td></tr> <tr><td>Leakage current</td><td>≤ The initial specified value</td></tr> </table>	Appearance	No significant damage	Capacitance change	≤ ±20% of the initial value	D.F. (tan δ)	≤ 150% of the initial specified value	ESR	≤ 150% of the initial specified value	Leakage current	≤ The initial specified value
Appearance	No significant damage										
Capacitance change	≤ ±20% of the initial value										
D.F. (tan δ)	≤ 150% of the initial specified value										
ESR	≤ 150% of the initial specified value										
Leakage current	≤ The initial specified value										
Surge Voltage	The capacitors shall be subjected to 1,000 cycles each consisting of charge with the surge voltage specified at 105°C for 30 seconds through a protective resistor (R=1kΩ) and discharge for 5 minutes 30 seconds. <table border="1"> <tr><td>Appearance</td><td>No significant damage</td></tr> <tr><td>Capacitance change</td><td>≤ ±20% of the initial value</td></tr> <tr><td>D.F. (tan δ)</td><td>≤ 150% of the initial specified value</td></tr> <tr><td>ESR</td><td>≤ 150% of the initial specified value</td></tr> <tr><td>Leakage current</td><td>≤ The initial specified value</td></tr> </table>	Appearance	No significant damage	Capacitance change	≤ ±20% of the initial value	D.F. (tan δ)	≤ 150% of the initial specified value	ESR	≤ 150% of the initial specified value	Leakage current	≤ The initial specified value
Appearance	No significant damage										
Capacitance change	≤ ±20% of the initial value										
D.F. (tan δ)	≤ 150% of the initial specified value										
ESR	≤ 150% of the initial specified value										
Leakage current	≤ The initial specified value										
Failure Rate	0.5% per 1,000 hours maximum (Confidence level 60% at 105°C)										

*Note : If any doubt arises, measure the leakage current after the following voltage treatment.
Voltage treatment : DC rated voltage is applied to the capacitors for 120 minutes at 105°C.

◆ DIMENSIONS [mm]

- Terminal Code : A

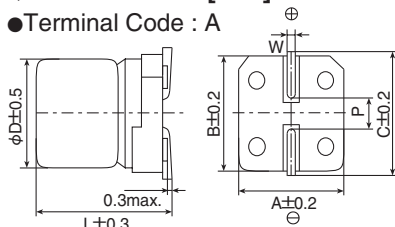

Size Code	φD	L	A	B	C	W	P
F61	6.3	5.8	6.6	6.6	7.2	0.5 to 0.8	1.9
F80	6.3	7.7	6.6	6.6	7.2	0.5 to 0.8	1.9
FA0	6.3	9.7	6.6	6.6	7.2	0.5 to 0.8	1.9
H70	8	6.7	8.3	8.3	9.0	0.7 to 1.1	3.1

◆ MARKING

EX) 2.5V820μF



Return Group Chart



CONDUCTIVE POLYMER ALUMINUM SOLID CAPACITORS

Surface Mount

NPCAP™-PXJ Series Upgrade!

◆PART NUMBERING SYSTEM

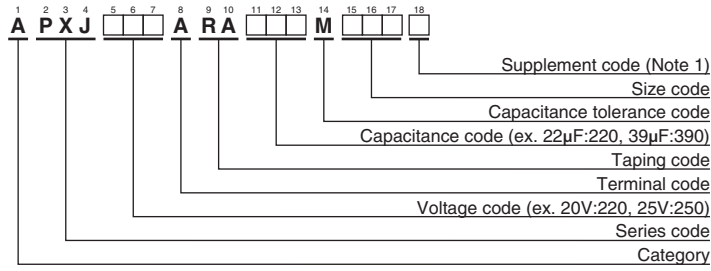

Please refer to "Product code guide (conductive polymer type)"

(Note1) :PXJ series, 16V270 μ F (Rated ripple current 5,080mArms) have supplement code "J". Terminal and terminal plating are the same as all other in PXJ series.

◆STANDARD RATINGS

WV (V _{dc})	Cap (μF)	Size code	Leakage current (μA max./after 2min.)	ESR (mΩ max./20°C, 100k to 300kHz)	Rated ripple current (mArms/105°C, 100kHz)	Part No.
2.5	820	F61	1,020	10	4,900	APXJ2R5ARA821MF61G
	820	F80	1,020	7	5,000	APXJ2R5ARA821MF80G
	820	FA0	1,020	10	4,300	APXJ2R5ARA821MFA0G
	1,000	FA0	1,250	10	4,300	APXJ2R5ARA102MFA0G
	1,200	FA0	1,500	10	4,300	APXJ2R5ARA122MFA0G
	1,200	H70	1,500	10	4,500	APXJ2R5ARA122MH70G
6.3	390	F61	1,220	10	4,900	APXJ6R3ARA391MF61G
	560	F80	1,760	8	5,000	APXJ6R3ARA561MF80G
	560	FA0	1,760	10	4,300	APXJ6R3ARA561MFA0G
	680	H70	2,140	10	4,500	APXJ6R3ARA681MH70G
10	270	F61	1,350	15	4,000	APXJ100ARA271MF61G
	390	F80	1,950	13	4,460	APXJ100ARA391MF80G
	390	FA0	1,950	13	4,000	APXJ100ARA391MFA0G
	470	H70	2,350	15	4,000	APXJ100ARA471MH70G
16	220	F61	704	20	3,500	APXJ160ARA221MF61G
	270	F80	864	10	5,080	APXJ160ARA271MF80J
	270	F80	864	13	4,460	APXJ160ARA271MF80G
	270	FA0	864	16	3,500	APXJ160ARA271MFA0G
	390	H70	1,240	25	3,600	APXJ160ARA391MH70G
20	150	F61	600	23	3,300	APXJ200ARA151MF61G
	150	F80	600	18	3,790	APXJ200ARA151MF80G
	150	FA0	600	18	3,200	APXJ200ARA151MFA0G
	220	H70	880	28	3,300	APXJ200ARA221MH70G
25	56	F61	280	28	3,000	APXJ250ARA560MF61G
	82	F80	410	28	3,040	APXJ250ARA820MF80G
	82	FA0	410	28	3,000	APXJ250ARA820MFA0G
	120	H70	600	38	3,200	APXJ250ARA121MH70G



NPCAP™-P_XG Series

- Super low ESR, high ripple current capability
- Rated voltage range : 16 to 25V_{dc}, Capacitance range : 10 to 1,000μF
- Case size : φ5×4.5L to φ10×12.2L
- Solvent resistant type (see PRECAUTIONS AND GUIDELINES)
- RoHS Compliant
- Halogen Free

P_XG

↑
Downsized
PXE P40



◆ SPECIFICATIONS

Items	Characteristics
Category	
Temperature Range	-55 to +105°C
Rated Voltage Range	16 to 25V _{dc}
Capacitance Tolerance	±20% (M) (at 20°C, 120Hz)
Surge Voltage	Rated voltage × 1.15 (at 105°C)
Leakage Current	Shall not exceed values shown in STANDARD RATINGS. (at 20°C after 2 minutes)
Dissipation Factor (tan δ)	0.12 max. (at 20°C, 120Hz)
Low Temperature Characteristics (Max. Impedance Ratio)	Z(-25°C)/Z(+20°C) ≤ 1.15 Z(-55°C)/Z(+20°C) ≤ 1.25 (at 100kHz)
Endurance	The following specifications shall be satisfied when the capacitors are restored to 20°C after the rated voltage is applied for 15,000 hours (E46,F45 : 3,000 hours) at 105°C.
Appearance	No significant damage
Capacitance change	≤ ±20% of the initial value
D.F. (tan δ)	≤ 150% of the initial specified value
ESR	≤ 150% of the initial specified value
Leakage current	≤ The initial specified value
Bias Humidity	The following specifications shall be satisfied when the capacitors are restored to 20°C after subjecting them to the DC rated voltage at 60°C, 90 to 95% RH for 1,000 hours (E46,F45 : 500 hours).
Appearance	No significant damage
Capacitance change	≤ ±20% of the initial value
D.F. (tan δ)	≤ 150% of the initial specified value
ESR	≤ 150% of the initial specified value
Leakage current	≤ The initial specified value
Surge Voltage	The capacitors shall be subjected to 1,000 cycles each consisting of charge with the surge voltage specified at 105°C for 30 seconds through a protective resistor (R=1kΩ) and discharge for 5 minutes 30 seconds.
Appearance	No significant damage
Capacitance change	≤ ±20% of the initial value
D.F. (tan δ)	≤ 150% of the initial specified value
ESR	≤ 150% of the initial specified value
Leakage current	≤ The initial specified value
Failure Rate	0.5% per 1,000 hours maximum (Confidence level 60% at 105°C)

*Note : If any doubt arises, measure the leakage current after the following voltage treatment.
Voltage treatment : DC rated voltage is applied to the capacitors for 120 minutes at 105°C.

◆ DIMENSIONS [mm]

● Terminal Code : A

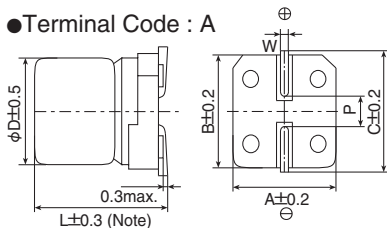

Note : L+0.1/-0.2 for E46 and F45
L±0.5 for HA0, JA0 and JC0

Size Code	φD	L	A	B	C	W	P
E46	5	4.5	5.3	5.3	5.9	0.5 to 0.8	1.4
E61	5	5.8	5.3	5.3	5.9	0.5 to 0.8	1.4
F45	6.3	4.4	6.6	6.6	7.2	0.5 to 0.8	1.9
F61	6.3	5.8	6.6	6.6	7.2	0.5 to 0.8	1.9
F80	6.3	7.7	6.6	6.6	7.2	0.5 to 0.8	1.9
H70	8	6.7	8.3	8.3	9.0	0.7 to 1.1	3.1
H80	8	7.7	8.3	8.3	9.0	0.7 to 1.1	3.1
HA0	8	10.0	8.3	8.3	9.0	0.7 to 1.1	3.1
J80	10	7.7	10.3	10.3	11.0	0.7 to 1.1	4.5
JA0	10	10.0	10.3	10.3	11.0	0.7 to 1.1	4.5
JC0	10	12.2	10.3	10.3	11.0	0.7 to 1.1	4.5

◆ MARKING

EX) 25V47μF



◆ PART NUMBERING SYSTEM

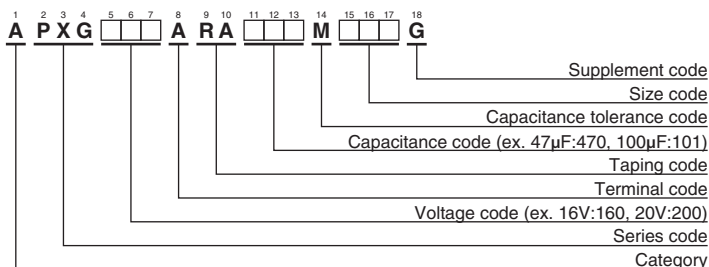

Please refer to "Product code guide (conductive polymer type)"

Return Group Chart



CONDUCTIVE POLYMER ALUMINUM SOLID CAPACITORS

Surface Mount

NPCAP™-P_XG Series

◆STANDARD RATINGS

WV (V _{dc})	Cap (μF)	Size code	Leakage current (μA max./after 2min.)	ESR (mΩ max./20°C, 100k to 300kHz)	Rated ripple current (mArms/105°C, 100kHz)	Part No.
16	39	E46	312	50	1,860	APXG160ARA390ME46G
	68	F45	544	40	2,450	APXG160ARA680MF45G
	100	E61	320	27	3,000	APXG160ARA101ME61G
	180	F61	576	22	3,300	APXG160ARA181MF61G
	220	F80	704	22	3,300	APXG160ARA221MF80G
	270	H70	864	22	3,300	APXG160ARA271MH70G
	330	H70	1,050	22	3,300	APXG160ARA331MH70G
	330	H80	1,050	21	3,400	APXG160ARA331MH80G
	330	HA0	1,050	21	3,400	APXG160ARA331MHA0G
	560	HA0	1,790	18	3,900	APXG160ARA561MHA0G
	560	J80	1,790	20	3,800	APXG160ARA561MJ80G
	820	JA0	2,620	16	4,200	APXG160ARA821MJA0G
	820	JC0	2,620	12	5,400	APXG160ARA821MJC0G
	1,000	JA0	3,200	18	4,100	APXG160ARA102MJA0G
1,000	JC0	3,200	12	5,400	APXG160ARA102MJC0G	
20	27	E46	270	55	1,770	APXG200ARA270ME46G
	47	E61	188	30	2,800	APXG200ARA470ME61G
	47	F45	470	42	2,400	APXG200ARA470MF45G
	56	E61	224	30	2,800	APXG200ARA560ME61G
	120	F61	480	25	3,200	APXG200ARA121MF61G
	150	F80	600	25	3,200	APXG200ARA151MF80G
	180	H70	720	25	3,200	APXG200ARA181MH70G
	220	H80	880	23	3,300	APXG200ARA221MH80G
	220	HA0	880	23	3,400	APXG200ARA221MHA0G
	390	HA0	1,560	20	3,700	APXG200ARA391MHA0G
	390	J80	1,560	22	3,650	APXG200ARA391MJ80G
	560	JA0	2,240	18	4,100	APXG200ARA561MJA0G
25	10	E46	125	60	1,700	APXG250ARA100ME46G
	22	E61	110	40	2,450	APXG250ARA220ME61G
	22	F45	275	45	2,350	APXG250ARA220MF45G
	27	E61	135	40	2,450	APXG250ARA270ME61G
	39	F61	195	30	2,800	APXG250ARA390MF61G
	47	F61	235	30	2,800	APXG250ARA470MF61G
	56	F61	280	30	2,800	APXG250ARA560MF61G
	56	F80	280	28	2,800	APXG250ARA560MF80G
	68	H70	340	28	3,000	APXG250ARA680MH70G
	82	H80	410	26	3,100	APXG250ARA820MH80G
	100	HA0	500	24	3,300	APXG250ARA101MHA0G
	120	HA0	600	22	3,500	APXG250ARA121MHA0G
	150	J80	750	25	3,400	APXG250ARA151MJ80G
	220	JA0	1,100	20	3,800	APXG250ARA221MJA0G

Product specifications in this catalog are subject to change without notice. Request our product specifications before purchase and/or use. Please use our products based on the information contained in this catalog and product specifications.



NPCAP™-PXX Series

- Super low ESR, impedance and high heat resistance have been obtained by using conductive polymer as electrolyte.
- Rated voltage range : 2.5 to 16V_{dc}, Capacitance range : 100 to 560μF
- Suitable for DC-DC converters, voltage regulators and decoupling applications used to computer motherboards etc.
- Solvent resistant type (see PRECAUTIONS AND GUIDELINES)
- RoHS Compliant
- Halogen Free

PXX
↑ Downsized
PXE P40



◆ SPECIFICATIONS

Items	Characteristics										
Category Temperature Range	-55 to +105°C										
Rated Voltage Range	2.5 to 16V _{dc}										
Capacitance Tolerance	±20% (M) (at 20°C, 120Hz)										
Surge Voltage	Rated voltage × 1.15V (at 105°C)										
Leakage Current	Shall not exceed values shown in STANDARD RATINGS. (at 20°C after 2 minutes)										
Dissipation Factor (tan δ)	0.12 max. (at 20°C, 120Hz)										
Low Temperature Characteristics (Max. Impedance Ratio)	Z(-25°C)/Z(+20°C) ≤ 1.15 Z(-55°C)/Z(+20°C) ≤ 1.25 (at 100kHz)										
Endurance	The following specifications shall be satisfied when the capacitors are restored to 20°C after the rated voltage is applied for 15,000 hours (F46 : 3,000 hours) at 105°C. <table border="1" style="width: 100%; border-collapse: collapse; margin-top: 5px;"> <tr><td>Appearance</td><td>No significant damage</td></tr> <tr><td>Capacitance change</td><td>≤ ±20% of the initial value</td></tr> <tr><td>D.F. (tan δ)</td><td>≤ 150% of the initial specified value</td></tr> <tr><td>ESR</td><td>≤ 150% of the initial specified value</td></tr> <tr><td>Leakage current</td><td>≤ The initial specified value</td></tr> </table>	Appearance	No significant damage	Capacitance change	≤ ±20% of the initial value	D.F. (tan δ)	≤ 150% of the initial specified value	ESR	≤ 150% of the initial specified value	Leakage current	≤ The initial specified value
Appearance	No significant damage										
Capacitance change	≤ ±20% of the initial value										
D.F. (tan δ)	≤ 150% of the initial specified value										
ESR	≤ 150% of the initial specified value										
Leakage current	≤ The initial specified value										
Bias Humidity	The following specifications shall be satisfied when the capacitors are restored to 20°C after subjecting them to the DC rated voltage at 60°C, 90 to 95% RH for 1,000 hours (F46 : 500hours). <table border="1" style="width: 100%; border-collapse: collapse; margin-top: 5px;"> <tr><td>Appearance</td><td>No significant damage</td></tr> <tr><td>Capacitance change</td><td>≤ ±20% of the initial value</td></tr> <tr><td>D.F. (tan δ)</td><td>≤ 150% of the initial specified value</td></tr> <tr><td>ESR</td><td>≤ 150% of the initial specified value</td></tr> <tr><td>Leakage current</td><td>≤ The initial specified value</td></tr> </table>	Appearance	No significant damage	Capacitance change	≤ ±20% of the initial value	D.F. (tan δ)	≤ 150% of the initial specified value	ESR	≤ 150% of the initial specified value	Leakage current	≤ The initial specified value
Appearance	No significant damage										
Capacitance change	≤ ±20% of the initial value										
D.F. (tan δ)	≤ 150% of the initial specified value										
ESR	≤ 150% of the initial specified value										
Leakage current	≤ The initial specified value										
Surge Voltage	The capacitors shall be subjected to 1,000 cycles each consisting of charge with the surge voltage specified at 105°C for 30 seconds through a protective resistor(R=1kΩ) and discharge for 5 minutes 30 seconds. <table border="1" style="width: 100%; border-collapse: collapse; margin-top: 5px;"> <tr><td>Appearance</td><td>No significant damage</td></tr> <tr><td>Capacitance change</td><td>≤ ±20% of the initial value</td></tr> <tr><td>D.F. (tan δ)</td><td>≤ 150% of the initial specified value</td></tr> <tr><td>ESR</td><td>≤ 150% of the initial specified value</td></tr> <tr><td>Leakage current</td><td>≤ The initial specified value</td></tr> </table>	Appearance	No significant damage	Capacitance change	≤ ±20% of the initial value	D.F. (tan δ)	≤ 150% of the initial specified value	ESR	≤ 150% of the initial specified value	Leakage current	≤ The initial specified value
Appearance	No significant damage										
Capacitance change	≤ ±20% of the initial value										
D.F. (tan δ)	≤ 150% of the initial specified value										
ESR	≤ 150% of the initial specified value										
Leakage current	≤ The initial specified value										
Failure Rate	0.5% per 1,000 hours maximum (Confidence level 60% at 105°C)										

*Note : If any doubt arises, measure the leakage current after following voltage treatment.
Voltage treatment : DC rated voltage are applied to the capacitors for 120 minutes at 105°C.

◆ DIMENSIONS [mm]

● Terminal Code : A

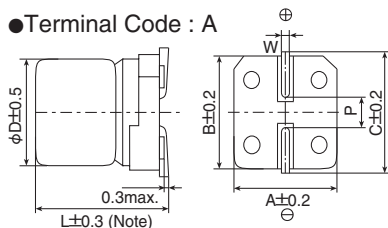

Note : L+0.1/-0.2 for F46

Size Code	φD	L	A	B	C	W	P
E61	5	5.8	5.3	5.3	5.9	0.5 to 0.8	1.4
F46	6.3	4.5	6.6	6.6	7.2	0.5 to 0.8	1.9
F61	6.3	5.8	6.6	6.6	7.2	0.5 to 0.8	1.9

◆ MARKING

EX) 2.5V330μF

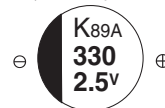

◆ PART NUMBERING SYSTEM

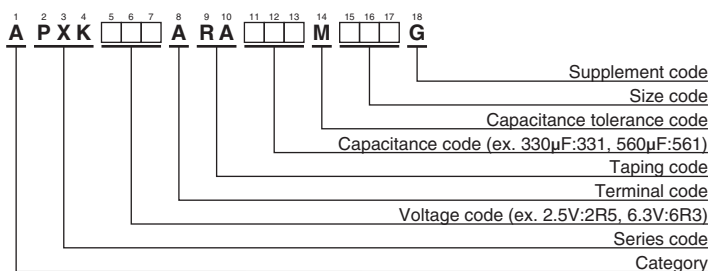

Please refer to "Product code guide (conductive polymer type)"

Return Group Chart



CONDUCTIVE POLYMER ALUMINUM SOLID CAPACITORS

Surface Mount

NPCAP™-P XK Series

◆STANDARD RATINGS

WV (V _{dc})	Cap (μF)	Size code	Leakage current (μA max./after 2min.)	ESR (mΩ max./20°C, 100k to 300kHz)	Rated ripple current (mA _{rms} /105°C, 100kHz)	Part No.
2.5	220	F46	300	19	2,780	APXK2R5ARA221MF46G
	330	E61	412	16	3,500	APXK2R5ARA331ME61G
	330	F46	700	16	3,500	APXK2R5ARA331MF46G
	560	F61	700	16	3,500	APXK2R5ARA561MF61G
4	180	F46	360	19	2,780	APXK4R0ARA181MF46G
	220	E61	440	17	3,390	APXK4R0ARA221ME61G
	390	F61	780	17	3,390	APXK4R0ARA391MF61G
6.3	150	F46	472	19	2,780	APXK6R3ARA151MF46G
	180	E61	567	17	3,390	APXK6R3ARA181ME61G
	220	F46	700	18	3,200	APXK6R3ARA221MF46G
	330	F61	1,040	17	3,390	APXK6R3ARA331MF61G
16	100	F61	320	24	2,490	APXK160ARA101MF61G

Return Group Chart



CONDUCTIVE POLYMER ALUMINUM SOLID CAPACITORS

Surface Mount

NPCAP™-PXS Series

- Super low ESR, high ripple current capability
- Longer life (20,000 hours at 105°C)
- Rated voltage range : 4 to 16V_{dc}, Capacitance range : 22 to 560μF
- Case size : φ5×5.8L to φ8×6.7L
- Suitable for DC-DC converters, voltage regulators and decoupling applications for computer motherboards etc.
- Solvent resistant type (see PRECAUTIONS AND GUIDELINES)
- RoHS Compliant
- Halogen Free

PXS

↑ Longer life

PXE/PXA
P40 P42



◆ SPECIFICATIONS

Items	Characteristics										
Category											
Temperature Range	-55 to +105°C										
Rated Voltage Range	4 to 16V _{dc}										
Capacitance Tolerance	±20% (M) (at 20°C, 120Hz)										
Surge Voltage	Rated voltage × 1.15 (at 105°C)										
Leakage Current	I=0.2CV Where, I : Max. leakage current (μA), C : Nominal capacitance (μF), V : Rated voltage (V _{dc}) (at 20°C after 2 minutes)										
Dissipation Factor (tan δ)	0.12 max. (at 20°C, 120Hz)										
Low Temperature Characteristics (Max. Impedance Ratio)	Z(-25°C)/Z(+20°C) ≤ 1.15 Z(-55°C)/Z(+20°C) ≤ 1.25 (at 100kHz)										
Endurance	The following specifications shall be satisfied when the capacitors are restored to 20°C after the rated voltage is applied for 20,000 hours at 105°C.										
	<table border="1"> <tr> <td>Appearance</td> <td>No significant damage</td> </tr> <tr> <td>Capacitance change</td> <td>≤ ±20% of the initial value</td> </tr> <tr> <td>D.F. (tan δ)</td> <td>≤ 150% of the initial specified value</td> </tr> <tr> <td>ESR</td> <td>≤ 150% of the initial specified value</td> </tr> <tr> <td>Leakage current</td> <td>≤ The initial specified value</td> </tr> </table>	Appearance	No significant damage	Capacitance change	≤ ±20% of the initial value	D.F. (tan δ)	≤ 150% of the initial specified value	ESR	≤ 150% of the initial specified value	Leakage current	≤ The initial specified value
Appearance	No significant damage										
Capacitance change	≤ ±20% of the initial value										
D.F. (tan δ)	≤ 150% of the initial specified value										
ESR	≤ 150% of the initial specified value										
Leakage current	≤ The initial specified value										
Bias Humidity	The following specifications shall be satisfied when the capacitors are restored to 20°C after subjecting them to the DC rated voltage at 60°C, 90 to 95% RH for 1,000 hours.										
	<table border="1"> <tr> <td>Appearance</td> <td>No significant damage</td> </tr> <tr> <td>Capacitance change</td> <td>≤ ±20% of the initial value</td> </tr> <tr> <td>D.F. (tan δ)</td> <td>≤ 150% of the initial specified value</td> </tr> <tr> <td>ESR</td> <td>≤ 150% of the initial specified value</td> </tr> <tr> <td>Leakage current</td> <td>≤ The initial specified value</td> </tr> </table>	Appearance	No significant damage	Capacitance change	≤ ±20% of the initial value	D.F. (tan δ)	≤ 150% of the initial specified value	ESR	≤ 150% of the initial specified value	Leakage current	≤ The initial specified value
Appearance	No significant damage										
Capacitance change	≤ ±20% of the initial value										
D.F. (tan δ)	≤ 150% of the initial specified value										
ESR	≤ 150% of the initial specified value										
Leakage current	≤ The initial specified value										
Surge Voltage	The capacitors shall be subjected to 1,000 cycles each consisting of charge with the surge voltage specified at 105°C for 30 seconds through a protective resistor (R=1kΩ) and discharge for 5 minutes 30 seconds.										
	<table border="1"> <tr> <td>Appearance</td> <td>No significant damage</td> </tr> <tr> <td>Capacitance change</td> <td>≤ ±20% of the initial value</td> </tr> <tr> <td>D.F. (tan δ)</td> <td>≤ 150% of the initial specified value</td> </tr> <tr> <td>ESR</td> <td>≤ 150% of the initial specified value</td> </tr> <tr> <td>Leakage current</td> <td>≤ The initial specified value</td> </tr> </table>	Appearance	No significant damage	Capacitance change	≤ ±20% of the initial value	D.F. (tan δ)	≤ 150% of the initial specified value	ESR	≤ 150% of the initial specified value	Leakage current	≤ The initial specified value
Appearance	No significant damage										
Capacitance change	≤ ±20% of the initial value										
D.F. (tan δ)	≤ 150% of the initial specified value										
ESR	≤ 150% of the initial specified value										
Leakage current	≤ The initial specified value										
Failure Rate	0.5% per 1,000 hours maximum (Confidence level 60% at 105°C)										

*Note : If any doubt arises, measure the leakage current after the following voltage treatment.
Voltage treatment : DC rated voltage is applied to the capacitors for 120 minutes at 105°C.

◆ DIMENSIONS [mm]^o

● Terminal Code : A

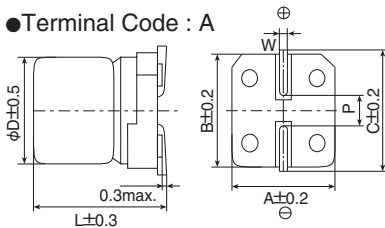

Size Code	φD	L	A	B	C	W	P
E61	5.0	5.8	5.3	5.3	5.9	0.5 to 0.8	1.4
F61	6.3	5.8	6.6	6.6	7.2	0.5 to 0.8	1.9
H70	8.0	6.7	8.3	8.3	9.0	0.7 to 1.1	3.1

◆ MARKING

EX) 6.3V390μF



◆ PART NUMBERING SYSTEM

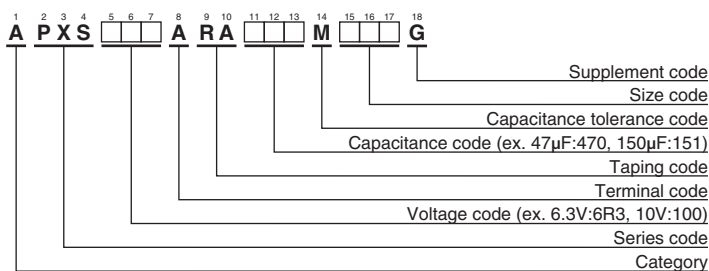

Please refer to "Product code guide (conductive polymer type)"

Return Group Chart



CONDUCTIVE POLYMER ALUMINUM SOLID CAPACITORS

Surface Mount

NPCAP™-PXS Series

◆STANDARD RATINGS

WV (V _{dc})	Cap (μF)	Size code	ESR (mΩ max./20°C, 100k to 300kHz)	Rated ripple current (mA rms/105°C, 100kHz)	Part No.
4	150	E61	25	2,150	APXS4R0ARA151ME61G
	560	H70	22	3,220	APXS4R0ARA561MH70G
6.3	47	E61	30	1,970	APXS6R3ARA470ME61G
	100	E61	25	2,150	APXS6R3ARA101ME61G
	120	F61	22	2,570	APXS6R3ARA121MF61G
	220	F61	22	2,570	APXS6R3ARA221MF61G
	390	H70	22	3,220	APXS6R3ARA391MH70G
10	33	E61	70	1,100	APXS100ARA330ME61G
	68	E61	30	1,970	APXS100ARA680ME61G
	120	F61	27	2,320	APXS100ARA121MF61G
	150	H70	30	2,760	APXS100ARA151MH70G
16	22	E61	90	1,060	APXS160ARA220ME61G
	39	E61	35	1,820	APXS160ARA390ME61G
	39	F61	37	2,050	APXS160ARA390MF61G
	68	F61	30	2,200	APXS160ARA680MF61G
	82	H70	30	2,760	APXS160ARA820MH70G
	120	H70	27	2,900	APXS160ARA121MH70G



NPCAP™-PXF Series

- Super low ESR, impedance and high heat resistance have been obtained by using conductive polymer as electrolyte.
- Rated voltage range : 2 to 10V_{dc}, Capacitance range : 120 to 1,000μF
- Case size range : φ 5x3.9L to φ 8x7.7L
- Suitable for DC-DC converters, voltage regulators and decoupling applications used on computer motherboards etc.
- Solvent resistant type (see PRECAUTIONS AND GUIDELINES)
- RoHS Compliant
- Halogen Free

PXF

↑ Lower ESR
PXE P40



◆ SPECIFICATIONS

Items	Characteristics										
Category											
Temperature Range	-55 to +105°C										
Rated Voltage Range	2 to 10V _{dc}										
Capacitance Tolerance	±20% (M) (at 20°C, 120Hz)										
Surge Voltage	Rated voltage × 1.15 (at 105°C)										
Leakage Current	Shall not exceed values shown in STANDARD RATINGS. (at 20°C after 2 minutes)										
Dissipation Factor (tan δ)	0.12 max. (at 20°C, 120Hz)										
Low Temperature Characteristics (Max. Impedance Ratio)	Z(-25°C)/Z(+20°C) ≤ 1.15 Z(-55°C)/Z(+20°C) ≤ 1.25 (at 100kHz)										
Endurance	The following specifications shall be satisfied when the capacitors are restored to 20°C after the rated voltage is applied for 15,000 hours (E40, E46, F45 : 3,000 hours) at 105°C.										
	<table border="1" style="width: 100%; border-collapse: collapse;"> <tr><td>Appearance</td><td>No significant damage</td></tr> <tr><td>Capacitance change</td><td>≤ ±20% of the initial value</td></tr> <tr><td>D.F. (tan δ)</td><td>≤ 150% of the initial specified value</td></tr> <tr><td>ESR</td><td>≤ 150% of the initial specified value</td></tr> <tr><td>Leakage current</td><td>≤ The initial specified value</td></tr> </table>	Appearance	No significant damage	Capacitance change	≤ ±20% of the initial value	D.F. (tan δ)	≤ 150% of the initial specified value	ESR	≤ 150% of the initial specified value	Leakage current	≤ The initial specified value
Appearance	No significant damage										
Capacitance change	≤ ±20% of the initial value										
D.F. (tan δ)	≤ 150% of the initial specified value										
ESR	≤ 150% of the initial specified value										
Leakage current	≤ The initial specified value										
Bias Humidity	The following specifications shall be satisfied when the capacitors are restored to 20°C after subjecting them to the DC rated voltage at 60°C, 90 to 95% RH for 1,000 hours (E40, E46, F45 : 500 hours).										
	<table border="1" style="width: 100%; border-collapse: collapse;"> <tr><td>Appearance</td><td>No significant damage</td></tr> <tr><td>Capacitance change</td><td>≤ ±20% of the initial value</td></tr> <tr><td>D.F. (tan δ)</td><td>≤ 150% of the initial specified value</td></tr> <tr><td>ESR</td><td>≤ 150% of the initial specified value</td></tr> <tr><td>Leakage current</td><td>≤ The initial specified value</td></tr> </table>	Appearance	No significant damage	Capacitance change	≤ ±20% of the initial value	D.F. (tan δ)	≤ 150% of the initial specified value	ESR	≤ 150% of the initial specified value	Leakage current	≤ The initial specified value
Appearance	No significant damage										
Capacitance change	≤ ±20% of the initial value										
D.F. (tan δ)	≤ 150% of the initial specified value										
ESR	≤ 150% of the initial specified value										
Leakage current	≤ The initial specified value										
Surge Voltage	The capacitors shall be subjected to 1,000 cycles each consisting of charge with the surge voltage specified at 105°C for 30 seconds through a protective resistor(R=1kΩ) and discharge for 5 minutes 30 seconds.										
	<table border="1" style="width: 100%; border-collapse: collapse;"> <tr><td>Appearance</td><td>No significant damage</td></tr> <tr><td>Capacitance change</td><td>≤ ±20% of the initial value</td></tr> <tr><td>D.F. (tan δ)</td><td>≤ 150% of the initial specified value</td></tr> <tr><td>ESR</td><td>≤ 150% of the initial specified value</td></tr> <tr><td>Leakage current</td><td>≤ The initial specified value</td></tr> </table>	Appearance	No significant damage	Capacitance change	≤ ±20% of the initial value	D.F. (tan δ)	≤ 150% of the initial specified value	ESR	≤ 150% of the initial specified value	Leakage current	≤ The initial specified value
Appearance	No significant damage										
Capacitance change	≤ ±20% of the initial value										
D.F. (tan δ)	≤ 150% of the initial specified value										
ESR	≤ 150% of the initial specified value										
Leakage current	≤ The initial specified value										
Failure Rate	0.5% per 1,000 hours maximum (Confidence level 60% at 105°C)										

*Note : If any doubt arises, measure the leakage current after the following voltage treatment.
Voltage treatment : DC rated voltage is applied to the capacitors for 120 minutes at 105°C.

◆ DIMENSIONS [mm]

● Terminal Code : A

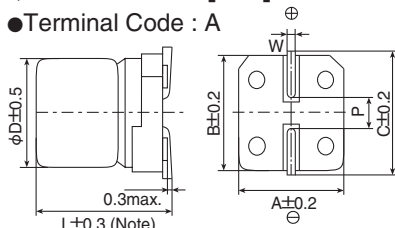

Size Code	φD	L	A	B	C	W	P
E40	5	3.9	5.3	5.3	5.9	0.5 to 0.8	1.4
E46	5	4.5	5.3	5.3	5.9	0.5 to 0.8	1.4
E61	5	5.8	5.3	5.3	5.9	0.5 to 0.8	1.4
F45	6.3	4.4	6.6	6.6	7.2	0.5 to 0.8	1.9
F61	6.3	5.8	6.6	6.6	7.2	0.5 to 0.8	1.9
F80	6.3	7.7	6.6	6.6	7.2	0.5 to 0.8	1.9
H70	8	6.7	8.3	8.3	9.0	0.7 to 1.1	3.1
H80	8	7.7	8.3	8.3	9.0	0.7 to 1.1	3.1

◆ MARKING

EX) 2.5V390μF



◆ PART NUMBERING SYSTEM

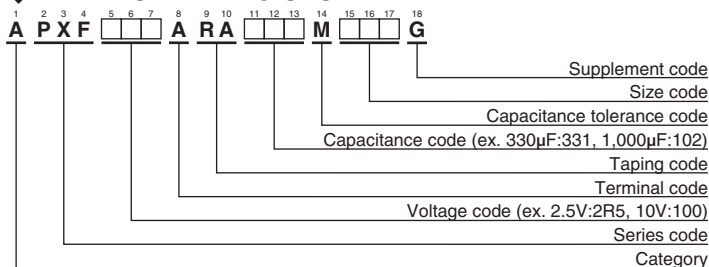

Please refer to "Product code guide (conductive polymer type)"

Return Group Chart



CONDUCTIVE POLYMER ALUMINUM SOLID CAPACITORS

Surface Mount

NPCAP™-PXF Series

◆STANDARD RATINGS

WV (V _{dc})	Cap (μF)	Size code	Leakage current (μA max./after 2min.)	ESR (mΩ max./20°C, 100k to 300kHz)	Rated ripple current (mA rms/105°C, 100kHz)	Part No.
2	680	F61	700	12	3,500	APXF2R0ARA681MF61G
	220	E40	700	12	3,300	APXF2R5ARA221ME40G
2.5	220	E46	700	25	2,100	APXF2R5ARA221ME46G
	330	E61	700	10	3,900	APXF2R5ARA331ME61G
	330	F45	700	12	3,500	APXF2R5ARA331MF45G
	390	E61	700	10	3,900	APXF2R5ARA391ME61G
	390	F61	292	10	3,900	APXF2R5ARA391MF61G
	470	F80	352	9	4,200	APXF2R5ARA471MF80G
	560	F61	700	10	3,900	APXF2R5ARA561MF61G
	560	F80	420	9	4,200	APXF2R5ARA561MF80G
	560	H70	420	10	4,500	APXF2R5ARA561MH70G
	680	H70	510	10	4,500	APXF2R5ARA681MH70G
	1,000	H80	750	9	4,500	APXF2R5ARA102MH80G
4	330	F61	396	10	3,900	APXF4R0ARA331MF61G
	390	F80	468	9	4,200	APXF4R0ARA391MF80G
	470	H70	564	10	4,500	APXF4R0ARA471MH70G
	560	H70	672	10	4,500	APXF4R0ARA561MH70G
	680	H80	816	9	4,500	APXF4R0ARA681MH80G
6.3	150	E40	700	20	2,700	APXF6R3ARA151ME40G
	150	E46	700	25	2,100	APXF6R3ARA151ME46G
	150	E61	700	12	3,500	APXF6R3ARA151ME61G
	220	E61	700	12	3,500	APXF6R3ARA221ME61G
	220	F61	415	10	3,900	APXF6R3ARA221MF61G
	270	F80	510	9	4,200	APXF6R3ARA271MF80G
	330	F61	700	10	3,900	APXF6R3ARA331MF61G
	330	F80	623	9	4,200	APXF6R3ARA331MF80G
	330	H70	623	10	4,500	APXF6R3ARA331MH70G
	390	H70	737	10	4,500	APXF6R3ARA391MH70G
	470	H80	888	9	4,500	APXF6R3ARA471MH80G
	560	H80	1,050	9	4,500	APXF6R3ARA561MH80G
	10	120	E61	240	22	2,600
270		F61	540	20	2,800	APXF100ARA271MF61G



NPCAP™-PXE Series

- Super low ESR, impedance and high heat resistance have been obtained by using conductive polymer as electrolyte.
(ESR and rated ripple current values are improved from PXA series.)
- Rated voltage range : 2.5 to 16V_{dc}, Capacitance range : 33 to 2,700μF
- Suitable for DC-DC converters, voltage regulators and decoupling applications used on computer motherboards etc.
- Solvent resistant type (see PRECAUTIONS AND GUIDELINES)
- RoHS Compliant
- Halogen Free

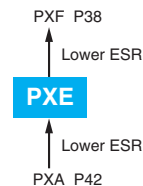

◆ SPECIFICATIONS

Items	Characteristics
Category	-55 to +105°C
Temperature Range	-55 to +105°C
Rated Voltage Range	2.5 to 16V _{dc}
Capacitance Tolerance	±20% (M) (at 20°C, 120Hz)
Surge Voltage	Rated voltage × 1.15 (at 105°C)
Leakage Current	Shall not exceed values shown in STANDARD RATINGS. (at 20°C after 2 minutes)
Dissipation Factor (tan δ)	0.12 max. (at 20°C, 120Hz)
Low Temperature Characteristics (Max. Impedance Ratio)	Z(-25°C)/Z(+20°C) ≤ 1.15 Z(-55°C)/Z(+20°C) ≤ 1.25 (at 100kHz)
Endurance	The following specifications shall be satisfied when the capacitors are restored to 20°C after the rated voltage is applied for 15,000 hours at 105°C.
Appearance	No significant damage
Capacitance change	≤ ±20% of the initial value
D.F. (tan δ)	≤ 150% of the initial specified value
ESR	≤ 150% of the initial specified value
Leakage current	≤ The initial specified value
Bias Humidity	The following specifications shall be satisfied when the capacitors are restored to 20°C after subjecting them to the DC rated voltage at 60°C, 90 to 95% RH for 1,000 hours.
Appearance	No significant damage
Capacitance change	≤ ±20% of the initial value
D.F. (tan δ)	≤ 150% of the initial specified value
ESR	≤ 150% of the initial specified value
Leakage current	≤ The initial specified value
Surge Voltage	The capacitors shall be subjected to 1,000 cycles each consisting of charge with the surge voltage specified at 105°C for 30 seconds through a protective resistor (R=1kΩ) and discharge for 5 minutes 30 seconds.
Appearance	No significant damage
Capacitance change	≤ ±20% of the initial value
D.F. (tan δ)	≤ 150% of the initial specified value
ESR	≤ 150% of the initial specified value
Leakage current	≤ The initial specified value
Failure Rate	0.5% per 1,000 hours maximum (Confidence level 60% at 105°C)

*Note : If any doubt arises, measure the leakage current after the following voltage treatment.
Voltage treatment : DC rated voltage is applied to the capacitors for 120 minutes at 105°C.

◆ DIMENSIONS [mm]

● Terminal Code : A

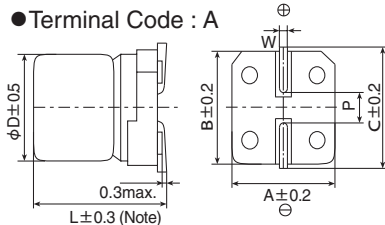

(Note) L ±0.5 for HA0, HC0, JA0, JC0

Size Code	φD	L	A	B	C	W	P
E61	5	5.8	5.3	5.3	5.9	0.5 to 0.8	1.4
F61	6.3	5.8	6.6	6.6	7.2	0.5 to 0.8	1.9
F80	6.3	7.7	6.6	6.6	7.2	0.5 to 0.8	1.9
H70	8	6.7	8.3	8.3	9.0	0.7 to 1.1	3.1
H80	8	7.7	8.3	8.3	9.0	0.7 to 1.1	3.1
HA0	8	10.0	8.3	8.3	9.0	0.7 to 1.1	3.1
HC0	8	12.0	8.3	8.3	9.0	0.7 to 1.1	3.1
J80	10	7.7	10.3	10.3	11.0	0.7 to 1.1	4.5
JA0	10	10.0	10.3	10.3	11.0	0.7 to 1.1	4.5
JC0	10	12.2	10.3	10.3	11.0	0.7 to 1.1	4.5

◆ MARKING

EX) 2.5V390μF



◆ PART NUMBERING SYSTEM

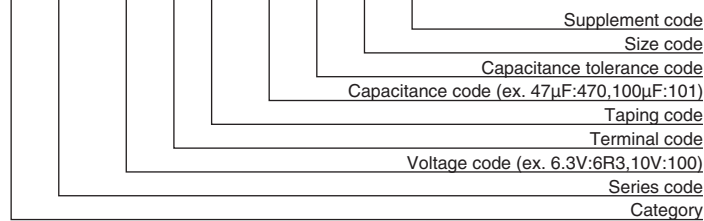

Category Please refer to "Product code guide (conductive polymer type)"

Return Group Chart



CONDUCTIVE POLYMER ALUMINUM SOLID CAPACITORS

Surface Mount

NPCAP™-PXE Series

◆STANDARD RATINGS

WV (V _{dc})	Cap (μF)	Size code	Leakage current (μA max./after 2min.)	ESR (mΩ max./20°C, 100k to 300kHz)	Rated ripple current (mA rms/105°C, 100kHz)	Part No.
2.5	180	E61	90.0	21	2,670	APXE2R5ARA181ME61G
	390	F61	195	15	3,160	APXE2R5ARA391MF61G
	470	F80	235	13	3,600	APXE2R5ARA471MF80G
	560	F80	280	13	3,600	APXE2R5ARA561MF80G
	560	H70	280	13	4,100	APXE2R5ARA561MH70G
	680	H70	340	13	4,100	APXE2R5ARA681MH70G
	820	H80	410	12	4,260	APXE2R5ARA821MH80G
	820	HC0	410	9	5,400	APXE2R5ARA821MHC0G
	1,000	H80	500	12	4,260	APXE2R5ARA102MH80G
	1,200	J80	600	13	4,450	APXE2R5ARA122MJ80G
	1,500	HA0	750	10	5,220	APXE2R5ARA152MHA0G
	1,500	HC0	750	9	5,400	APXE2R5ARA152MHC0G
2,200	JA0	1,100	10	5,500	APXE2R5ARA222MJA0G	
2,700	JC0	1,350	9	5,600	APXE2R5ARA272MJC0G	
4	100	E61	80.0	22	2,610	APXE4R0ARA101ME61G
	150	E61	120	22	2,610	APXE4R0ARA151ME61G
	270	F61	216	15	3,160	APXE4R0ARA271MF61G
	330	F61	264	15	3,160	APXE4R0ARA331MF61G
	390	F80	312	14	3,470	APXE4R0ARA391MF80G
	470	H70	376	14	3,950	APXE4R0ARA471MH70G
	560	H70	448	14	3,950	APXE4R0ARA561MH70G
	680	H80	544	13	3,950	APXE4R0ARA681MH80G
	1,000	HA0	800	10	5,220	APXE4R0ARA102MHA0G
	1,000	J80	800	14	4,300	APXE4R0ARA102MJ80G
	1,200	HC0	960	9	5,400	APXE4R0ARA122MHC0G
	1,200	JA0	960	10	5,500	APXE4R0ARA122MJA0G
1,500	JA0	1,200	10	5,500	APXE4R0ARA152MJA0G	
1,800	JA0	1,440	10	5,500	APXE4R0ARA182MJA0G	
1,800	JC0	1,440	9	5,600	APXE4R0ARA182MJC0G	
6.3	100	E61	126	24	2,500	APXE6R3ARA101ME61G
	120	E61	151	24	2,500	APXE6R3ARA121ME61G
	220	F61	277	15	3,160	APXE6R3ARA221MF61G
	270	F80	340	14	3,470	APXE6R3ARA271MF80G
	330	F80	415	14	3,470	APXE6R3ARA331MF80G
	330	H70	415	14	3,950	APXE6R3ARA331MH70G
	390	H70	491	14	3,950	APXE6R3ARA391MH70G
	470	H80	592	13	3,950	APXE6R3ARA471MH80G
	820	HA0	1,030	12	4,770	APXE6R3ARA821MHA0G
	820	HC0	1,030	10	5,150	APXE6R3ARA821MHC0G
	820	J80	1,030	14	4,300	APXE6R3ARA821MJ80G
	1,200	JA0	1,510	12	5,025	APXE6R3ARA122MJA0G
1,500	JA0	1,890	12	5,025	APXE6R3ARA152MJA0G	
1,500	JC0	1,890	10	5,500	APXE6R3ARA152MJC0G	
10	47	E61	94.0	28	2,310	APXE100ARA470ME61G
	56	E61	112	28	2,310	APXE100ARA560ME61G
	68	E61	136	28	2,310	APXE100ARA680ME61G
	120	F61	240	25	2,530	APXE100ARA121MF61G
	150	F80	300	21	2,880	APXE100ARA151MF80G
	220	H70	440	21	3,220	APXE100ARA221MH70G
	270	H70	540	21	3,220	APXE100ARA271MH70G
	330	H80	660	19	3,390	APXE100ARA331MH80G
	390	HA0	780	17	4,000	APXE100ARA391MHA0G
470	J80	940	19	3,800	APXE100ARA471MJ80G	
680	JA0	1,360	13	4,820	APXE100ARA681MJA0G	
16	33	E61	105	35	2,070	APXE160ARA330ME61G
	39	E61	124	35	2,070	APXE160ARA390ME61G
	68	F61	217	28	2,390	APXE160ARA680MF61G
	82	F80	262	24	2,700	APXE160ARA820MF80G
	100	F80	320	24	2,700	APXE160ARA101MF80G
	100	H70	320	24	3,010	APXE160ARA101MH70G
	120	H70	384	24	3,010	APXE160ARA121MH70G
	150	H80	480	22	3,150	APXE160ARA151MH80G
	180	HA0	576	18	3,890	APXE160ARA181MHA0G
	220	HA0	704	18	3,890	APXE160ARA221MHA0G
220	J80	704	22	3,450	APXE160ARA221MJ80G	
330	JA0	1,050	16	4,350	APXE160ARA331MJA0G	

Product specifications in this catalog are subject to change without notice. Request our product specifications before purchase and/or use. Please use our products based on the information contained in this catalog and product specifications.



NPCAP™-PXA Series

- Super low ESR, impedance and high heat resistance have been obtained by using conductive polymer as electrolyte
- Rated voltage range : 2.5 to 25V_{dc}, case size range : φ4×5.2L to φ10×12.2L
- Suitable for DC-DC converters, voltage regulators and decoupling applications used on computer motherboards etc.
- Solvent resistant type (see PRECAUTIONS AND GUIDELINES)
- RoHS Compliant
- Halogen Free



◆ SPECIFICATIONS

Items	Characteristics										
Category	-55 to +105°C										
Temperature Range											
Rated Voltage Range	2.5 to 25V _{dc}										
Capacitance Tolerance	±20% (M) (at 20°C, 120Hz)										
Surge Voltage	Rated voltage × 1.15 (Rated voltage 2.5 to 20V _{dc} , 25V _{dc}) / Rated voltage × 1.00 (Rated voltage 23V _{dc}) (at 105°C)										
Leakage Current	Shall not exceed values shown in STANDARD RATINGS. (at 20°C after 2 minutes)										
Dissipation Factor (tan δ)	0.12 max. (at 20°C, 120Hz)										
Low Temperature Characteristics (Max. Impedance Ratio)	Z(-25°C)/Z(+20°C) ≤ 1.15 Z(-55°C)/Z(+20°C) ≤ 1.25 (at 100kHz)										
Endurance	The following specifications shall be satisfied when the capacitors are restored to 20°C after the rated voltage is applied for 15,000 hours (F45 : 3,000 hours) at 105°C.										
	<table border="1" style="width: 100%; border-collapse: collapse;"> <tr><td>Appearance</td><td>No significant damage</td></tr> <tr><td>Capacitance change</td><td>≤ ±20% of the initial value</td></tr> <tr><td>D.F. (tan δ)</td><td>≤ 150% of the initial specified value</td></tr> <tr><td>ESR</td><td>≤ 150% of the initial specified value</td></tr> <tr><td>Leakage current</td><td>≤ The initial specified value</td></tr> </table>	Appearance	No significant damage	Capacitance change	≤ ±20% of the initial value	D.F. (tan δ)	≤ 150% of the initial specified value	ESR	≤ 150% of the initial specified value	Leakage current	≤ The initial specified value
Appearance	No significant damage										
Capacitance change	≤ ±20% of the initial value										
D.F. (tan δ)	≤ 150% of the initial specified value										
ESR	≤ 150% of the initial specified value										
Leakage current	≤ The initial specified value										
Bias Humidity	The following specifications shall be satisfied when the capacitors are restored to 20°C after subjecting them to the DC rated voltage at 60°C, 90 to 95% RH for 1,000 hours (F45 : 500 hours).										
	<table border="1" style="width: 100%; border-collapse: collapse;"> <tr><td>Appearance</td><td>No significant damage</td></tr> <tr><td>Capacitance change</td><td>≤ ±20% of the initial value</td></tr> <tr><td>D.F. (tan δ)</td><td>≤ 150% of the initial specified value</td></tr> <tr><td>ESR</td><td>≤ 150% of the initial specified value</td></tr> <tr><td>Leakage current</td><td>≤ The initial specified value</td></tr> </table>	Appearance	No significant damage	Capacitance change	≤ ±20% of the initial value	D.F. (tan δ)	≤ 150% of the initial specified value	ESR	≤ 150% of the initial specified value	Leakage current	≤ The initial specified value
Appearance	No significant damage										
Capacitance change	≤ ±20% of the initial value										
D.F. (tan δ)	≤ 150% of the initial specified value										
ESR	≤ 150% of the initial specified value										
Leakage current	≤ The initial specified value										
Surge Voltage	The capacitors shall be subjected to 1,000 cycles each consisting of charge with the surge voltage specified at 105°C for 30 seconds through a protective resistor (R=1kΩ) and discharge for 5 minutes 30 seconds.										
	<table border="1" style="width: 100%; border-collapse: collapse;"> <tr><td>Appearance</td><td>No significant damage</td></tr> <tr><td>Capacitance change</td><td>≤ ±20% of the initial value</td></tr> <tr><td>D.F. (tan δ)</td><td>≤ 150% of the initial specified value</td></tr> <tr><td>ESR</td><td>≤ 150% of the initial specified value</td></tr> <tr><td>Leakage current</td><td>≤ The initial specified value</td></tr> </table>	Appearance	No significant damage	Capacitance change	≤ ±20% of the initial value	D.F. (tan δ)	≤ 150% of the initial specified value	ESR	≤ 150% of the initial specified value	Leakage current	≤ The initial specified value
Appearance	No significant damage										
Capacitance change	≤ ±20% of the initial value										
D.F. (tan δ)	≤ 150% of the initial specified value										
ESR	≤ 150% of the initial specified value										
Leakage current	≤ The initial specified value										
Failure Rate	0.5% per 1,000 hours maximum (Confidence level 60% at 105°C)										

*Note : If any doubt arises, measure the leakage current after the following voltage treatment.
Voltage treatment : DC rated voltage is applied to the capacitors for 120 minutes at 105°C.

◆ DIMENSIONS [mm]

● Terminal Code : A

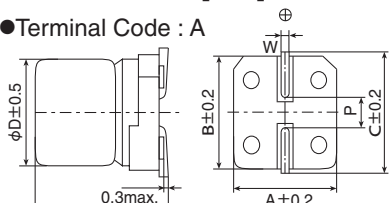

Note : L+0.1/-0.2 for F45
L±0.5 for HC0 and JC0

Size code	φD	L	A	B	C	W	P
D55	4	5.2	4.3	4.3	5.1	0.5 to 0.8	1.0
E60	5	5.7	5.3	5.3	5.9	0.5 to 0.8	1.4
F45	6.3	4.4	6.6	6.6	7.2	0.5 to 0.8	1.9
F55	6.3	5.2	6.6	6.6	7.2	0.5 to 0.8	1.9
F60	6.3	5.7	6.6	6.6	7.2	0.5 to 0.8	1.9
H70	8	6.7	8.3	8.3	9.0	0.7 to 1.1	3.1
HC0	8	12.0	8.3	8.3	9.0	0.7 to 1.1	3.1
J80	10	7.7	10.3	10.3	11.0	0.7 to 1.1	4.5
JC0	10	12.2	10.3	10.3	11.0	0.7 to 1.1	4.5

◆ MARKING

EX) 16V39μF



◆ PART NUMBERING SYSTEM

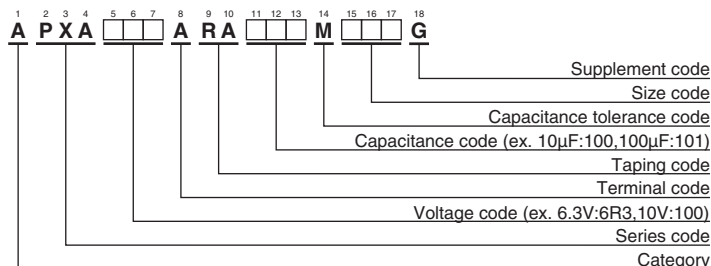

Please refer to "Product code guide (conductive polymer type)"

Return Group Chart



CONDUCTIVE POLYMER ALUMINUM SOLID CAPACITORS

Surface Mount

NPCAP™-PXA Series

◆STANDARD RATINGS

WV (V _{ac})	Cap (μF)	Size code	Leakage current (μA max./ after 2 min.)	ESR (mΩ max./ 20°C, 100k to 300kHz)	Rated ripple current (mA rms/105°C, 100kHz)	Part No.	WV (V _{ac})	Cap (μF)	Size code	Leakage current (μA max./ after 2 min.)	ESR (mΩ max./ 20°C, 100k to 300kHz)	Rated ripple current (mA rms/105°C, 100kHz)	Part No.
2.5	220	F55	110	25	2,500	APXA2R5ARA221MF55G	10	4.7	D55	24.0	240	670	APXA100ARA4R7MD55G
	220	F60	110	25	2,500	APXA2R5ARA221MF60G		6.8	D55	34.0	240	670	APXA100ARA6R8MD55G
	560	H70	280	23	3,100	APXA2R5ARA561MH70G		10	D55	50.0	220	700	APXA100ARA100MD55G
	680	HCO	340	12	4,770	APXA2R5ARA681MHC0G		15	D55	75.0	200	740	APXA100ARA150MD55G
	1,000	J80	500	19	4,240	APXA2R5ARA102MJ80G		33	E60	66.0	40	1,270	APXA100ARA330ME60G
	1,500	JCO	750	10	5,500	APXA2R5ARA152MJCOG		47	E60	94.0	40	1,270	APXA100ARA470ME60G
4	33	D55	66.0	200	740	APXA4R0ARA330MD55G	47	F45	235	41	1,560	APXA100ARA470MF45G	
	100	F55	80.0	26	2,450	APXA4R0ARA101MF55G	47	F60	94.0	31	2,250	APXA100ARA470MF60G	
	100	F60	80.0	26	2,450	APXA4R0ARA101MF60G	56	F55	112	31	2,250	APXA100ARA560MF55G	
	120	F45	240	38	1,710	APXA4R0ARA121MF45G	56	F60	112	31	2,250	APXA100ARA560MF60G	
	150	E60	120	30	1,490	APXA4R0ARA151ME60G	120	H70	240	27	2,800	APXA100ARA121MH70G	
	150	F55	120	26	2,450	APXA4R0ARA151MF55G	150	H70	300	27	2,800	APXA100ARA151MH70G	
	150	F60	120	26	2,450	APXA4R0ARA151MF60G	270	HCO	540	14	4,420	APXA100ARA271MHC0G	
	220	H70	176	25	3,020	APXA4R0ARA221MH70G	270	J80	540	24	3,770	APXA100ARA271MJ80G	
	330	H70	264	25	3,020	APXA4R0ARA331MH70G	330	HCO	660	14	4,420	APXA100ARA331MHC0G	
	470	J80	376	20	4,130	APXA4R0ARA471MJ80G	330	J80	660	24	3,770	APXA100ARA331MJ80G	
	560	HCO	448	12	4,770	APXA4R0ARA561MHC0G	470	JCO	940	12	5,300	APXA100ARA471MJCOG	
	680	J80	544	20	4,130	APXA4R0ARA681MJ80G	560	JCO	1,120	12	5,300	APXA100ARA561MJCOG	
820	JCO	656	10	5,500	APXA4R0ARA821MJCOG	16	3.3	D55	26.0	260	660	APXA160ARA3R3MD55G	
1,200	JCO	960	10	5,500	APXA4R0ARA122MJCOG		22	E60	70.4	45	1,210	APXA160ARA220ME60G	
6.3	22	D55	69.0	200	740		APXA6R3ARA220MD55G	22	F45	176	45	1,490	APXA160ARA220MF45G
	47	E60	59.2	35	1,380		APXA6R3ARA470ME60G	33	F60	106	37	2,050	APXA160ARA330MF60G
	68	F60	85.6	27	2,400		APXA6R3ARA680MF60G	39	F55	125	37	2,050	APXA160ARA390MF55G
	82	F45	267	40	1,670		APXA6R3ARA820MF45G	39	F60	125	37	2,050	APXA160ARA390MF60G
	82	F55	103	27	2,400		APXA6R3ARA820MF55G	82	H70	262	30	2,700	APXA160ARA820MH70G
	82	F60	103	27	2,400		APXA6R3ARA820MF60G	150	J80	480	26	3,430	APXA160ARA151MJ80G
	100	E60	126	35	1,380		APXA6R3ARA101ME60G	180	HCO	576	16	4,360	APXA160ARA181MHC0G
	100	F45	315	40	1,670		APXA6R3ARA101MF45G	180	J80	576	26	3,430	APXA160ARA181MJ80G
	100	F55	126	27	2,400		APXA6R3ARA101MF55G	220	JCO	704	14	5,050	APXA160ARA221MJCOG
	100	F60	126	27	2,400		APXA6R3ARA101MF60G	330	JCO	1,050	14	5,050	APXA160ARA331MJCOG
	120	F60	151	27	2,400	APXA6R3ARA121MF60G	20	15	F45	150	57	1,300	APXA200ARA150MF45G
	150	H70	189	25	3,020	APXA6R3ARA151MH70G		22	F55	88.0	50	1,650	APXA200ARA220MF55G
220	H70	277	25	3,020	APXA6R3ARA221MH70G	22		F60	88.0	50	1,650	APXA200ARA220MF60G	
330	J80	416	20	4,130	APXA6R3ARA331MJ80G	39		H70	156	45	2,000	APXA200ARA390MH70G	
390	HCO	491	12	4,770	APXA6R3ARA391MHC0G	47		H70	188	45	2,000	APXA200ARA470MH70G	
470	HCO	592	12	4,770	APXA6R3ARA471MHC0G	82		J80	328	40	2,500	APXA200ARA820MJ80G	
470	J80	592	20	4,130	APXA6R3ARA471MJ80G	150	JCO	600	20	4,320	APXA200ARA151MJCOG		
680	JCO	857	10	5,500	APXA6R3ARA681MJCOG	23	15	F45	172	57	1,300	APXA230ARA150MF45G	
820	JCO	1,030	10	5,500	APXA6R3ARA821MJCOG		10	F60	125	65	1,500	APXA250ARA100MF60G	
25	22	H70	275	50	1,800		APXA250ARA220MH70G	22	H70	275	50	1,800	APXA250ARA220MH70G
	39	J80	488	45	2,100	APXA250ARA390MJ80G	39	J80	488	45	2,100	APXA250ARA390MJ80G	



NPCAP™-PXD Series

- Super low ESR, impedance and high heat resistance have been obtained by using conductive polymer as electrolyte.
- For automobile modules and other high temperature applications
- Endurance : 125°C 2,000 hours
- Rated voltage range : 2.5 to 10V_{dc}, Capacitance range : 47 to 470μF
- Solvent resistant type (see PRECAUTIONS AND GUIDELINES)
- RoHS Compliant
- Halogen Free
- AEC-Q200 compliant : Please contact Chemi-Con for more details, test data, information.

PXD

↑
Longer life

PXH P46



◆ SPECIFICATIONS

Items	Characteristics										
Category	-55 to +125°C										
Temperature Range											
Rated Voltage Range	2.5 to 10V _{dc}										
Capacitance Tolerance	±20% (M) (at 20°C, 120Hz)										
Surge Voltage	Rated voltage × 1.15 (at 125°C)										
Leakage Current	Shall not exceed values shown in STANDARD RATINGS. (at 20°C after 2 minutes)										
Dissipation Factor (tan δ)	0.12 max. (at 20°C, 120Hz)										
Low Temperature Characteristics (Max. Impedance Ratio)	Z(-25°C)/Z(+20°C) ≤ 1.15 Z(-55°C)/Z(+20°C) ≤ 1.25 (at 100kHz)										
Endurance	The following specifications shall be satisfied when the capacitors are restored to 20°C after the rated voltage is applied for 2,000 hours at 125°C.										
	<table border="1" style="width: 100%; border-collapse: collapse;"> <tr><td>Appearance</td><td>No significant damage</td></tr> <tr><td>Capacitance change</td><td>≤ ±20% of the initial value</td></tr> <tr><td>D.F. (tan δ)</td><td>≤ 200% of the initial specified value</td></tr> <tr><td>ESR</td><td>≤ 200% of the initial specified value</td></tr> <tr><td>Leakage current</td><td>≤ The initial specified value</td></tr> </table>	Appearance	No significant damage	Capacitance change	≤ ±20% of the initial value	D.F. (tan δ)	≤ 200% of the initial specified value	ESR	≤ 200% of the initial specified value	Leakage current	≤ The initial specified value
Appearance	No significant damage										
Capacitance change	≤ ±20% of the initial value										
D.F. (tan δ)	≤ 200% of the initial specified value										
ESR	≤ 200% of the initial specified value										
Leakage current	≤ The initial specified value										
Bias Humidity	The following specifications shall be satisfied when the capacitors are restored to 20°C after subjecting them to the DC rated voltage at 60°C, 90 to 95% RH for 1,000 hours.										
	<table border="1" style="width: 100%; border-collapse: collapse;"> <tr><td>Appearance</td><td>No significant damage</td></tr> <tr><td>Capacitance change</td><td>≤ ±20% of the initial value</td></tr> <tr><td>D.F. (tan δ)</td><td>≤ 150% of the initial specified value</td></tr> <tr><td>ESR</td><td>≤ 150% of the initial specified value</td></tr> <tr><td>Leakage current</td><td>≤ The initial specified value</td></tr> </table>	Appearance	No significant damage	Capacitance change	≤ ±20% of the initial value	D.F. (tan δ)	≤ 150% of the initial specified value	ESR	≤ 150% of the initial specified value	Leakage current	≤ The initial specified value
Appearance	No significant damage										
Capacitance change	≤ ±20% of the initial value										
D.F. (tan δ)	≤ 150% of the initial specified value										
ESR	≤ 150% of the initial specified value										
Leakage current	≤ The initial specified value										
Surge Voltage	The capacitors shall be subjected to 1,000 cycles each consisting of charge with the surge voltage specified at 125°C for 30 seconds through a protective resistor(R=1kΩ) and discharge for 5 minutes 30 seconds.										
	<table border="1" style="width: 100%; border-collapse: collapse;"> <tr><td>Appearance</td><td>No significant damage</td></tr> <tr><td>Capacitance change</td><td>≤ ±20% of the initial value</td></tr> <tr><td>D.F. (tan δ)</td><td>≤ 150% of the initial specified value</td></tr> <tr><td>ESR</td><td>≤ 150% of the initial specified value</td></tr> <tr><td>Leakage current</td><td>≤ The initial specified value</td></tr> </table>	Appearance	No significant damage	Capacitance change	≤ ±20% of the initial value	D.F. (tan δ)	≤ 150% of the initial specified value	ESR	≤ 150% of the initial specified value	Leakage current	≤ The initial specified value
Appearance	No significant damage										
Capacitance change	≤ ±20% of the initial value										
D.F. (tan δ)	≤ 150% of the initial specified value										
ESR	≤ 150% of the initial specified value										
Leakage current	≤ The initial specified value										
Failure Rate	0.5% per 1,000 hours maximum (Confidence level 60% at 125°C)										

*Note : If any doubt arises, measure the leakage current after the following voltage treatment.
Voltage treatment : DC rated voltage is applied to the capacitors for 120 minutes at 125°C.

◆ DIMENSIONS [mm]

● Terminal Code : A

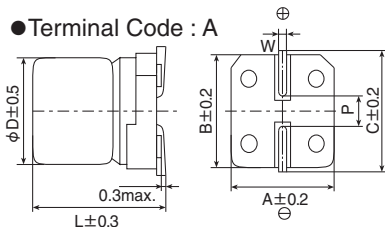

Size code	φD	L	A	B	C	W	P
E61	5	5.8	5.3	5.3	5.9	0.5 to 0.8	1.4
F61	6.3	5.8	6.6	6.6	7.2	0.5 to 0.8	1.9
H70	8	6.7	8.3	8.3	9.0	0.7 to 1.1	3.1
J80	10	7.7	10.3	10.3	11.0	0.7 to 1.1	4.5

◆ MARKING

EX) 10V330μF



◆ PART NUMBERING SYSTEM

1 2 3 4 5 6 7 8 9 10 11 12 13 14 15 16 17 18
A PXD [] [] A RA [] [] M [] [] G

- Supplement code
- Size code
- Capacitance tolerance code
- Capacitance code (ex. 47μF:470,100μF:101)
- Taping code
- Terminal code
- Voltage code (ex. 6.3V:6R3,10V:100)
- Series code
- Category

Please refer to "Product code guide (conductive polymer type)"

Return Group Chart



CONDUCTIVE POLYMER ALUMINUM SOLID CAPACITORS

Surface Mount

NPCAP™-PXD Series

◆STANDARD RATINGS

WV (V _{dc})	Cap (μF)	Size code	Leakage current (μA max./after 2min.)	ESR (mΩ max./20°C, 100k to 300kHz)	Rated ripple current (mA _{rms} /100kHz)		Part No.
					-55°C ≤ T _x ≤ +105°C ^{*1}	+105°C < T _x ≤ +125°C ^{*1}	
2.5	120	E61	60.0	40	1,450	650	APXD2R5ARA121ME61G
	220	F61	110	30	2,500	770	APXD2R5ARA221MF61G
6.3	56	E61	70.5	45	1,380	600	APXD6R3ARA560ME61G
	100	F61	126	35	2,400	720	APXD6R3ARA101MF61G
	220	H70	277	30	3,020	960	APXD6R3ARA221MH70G
	470	J80	592	25	3,500	1,100	APXD6R3ARA471MJ80G
10	47	E61	94.0	50	1,270	550	APXD100ARA470ME61G
	56	F61	112	40	2,250	680	APXD100ARA560MF61G
	150	H70	300	35	2,800	880	APXD100ARA151MH70G
	330	J80	660	25	3,500	1,100	APXD100ARA331MJ80G

*1 T_x : Ambient temperature (°C)



NPCAP™-PXH Series

- Super low ESR, impedance and high heat resistance have been obtained by using conductive polymer as electrolyte.
- Suitable for DC-DC converters, voltage regulators and decoupling applications.
- Endurance : 125°C 1,000 hours
- Rated voltage range : 2.5 to 20V_{dc}, Capacitance range : 22 to 1,000μF
- Case size range : φ6.3×5.7L to φ10×7.7L
- Solvent resistant type (see PRECAUTIONS AND GUIDELINES)
- RoHS Compliant
- Halogen Free

PXH

↑
Higher temperature
PXA P42



◆ SPECIFICATIONS

Items	Characteristics										
Category	-55 to +125°C										
Temperature Range											
Rated Voltage Range	2.5 to 20V _{dc}										
Capacitance Tolerance	±20% (M) (at 20°C, 120Hz)										
Surge Voltage	Rated voltage × 1.15 (at 125°C)										
Leakage Current	Shall not exceed values shown in STANDARD RATINGS. (at 20°C after 2 minutes)										
Dissipation Factor (tan δ)	0.12 max. (at 20°C, 120Hz)										
Low Temperature Characteristics (Max. Impedance Ratio)	Z(-25°C)/Z(+20°C) ≤ 1.15 Z(-55°C)/Z(+20°C) ≤ 1.25 (at 100kHz)										
Endurance	The following specifications shall be satisfied when the capacitors are restored to 20°C after the rated voltage is applied for 1,000 hours at 125°C.										
	<table border="1" style="width: 100%; border-collapse: collapse;"> <tr><td>Appearance</td><td>No significant damage</td></tr> <tr><td>Capacitance change</td><td>≤ ±20% of the initial value</td></tr> <tr><td>D.F. (tan δ)</td><td>≤ 200% of the initial specified value</td></tr> <tr><td>ESR</td><td>≤ 200% of the initial specified value</td></tr> <tr><td>Leakage current</td><td>≤ The initial specified value</td></tr> </table>	Appearance	No significant damage	Capacitance change	≤ ±20% of the initial value	D.F. (tan δ)	≤ 200% of the initial specified value	ESR	≤ 200% of the initial specified value	Leakage current	≤ The initial specified value
Appearance	No significant damage										
Capacitance change	≤ ±20% of the initial value										
D.F. (tan δ)	≤ 200% of the initial specified value										
ESR	≤ 200% of the initial specified value										
Leakage current	≤ The initial specified value										
Bias Humidity	The following specifications shall be satisfied when the capacitors are restored to 20°C after subjecting them to the DC rated voltage at 60°C, 90 to 95% RH for 1,000 hours.										
	<table border="1" style="width: 100%; border-collapse: collapse;"> <tr><td>Appearance</td><td>No significant damage</td></tr> <tr><td>Capacitance change</td><td>≤ ±20% of the initial value</td></tr> <tr><td>D.F. (tan δ)</td><td>≤ 150% of the initial specified value</td></tr> <tr><td>ESR</td><td>≤ 150% of the initial specified value</td></tr> <tr><td>Leakage current</td><td>≤ The initial specified value</td></tr> </table>	Appearance	No significant damage	Capacitance change	≤ ±20% of the initial value	D.F. (tan δ)	≤ 150% of the initial specified value	ESR	≤ 150% of the initial specified value	Leakage current	≤ The initial specified value
Appearance	No significant damage										
Capacitance change	≤ ±20% of the initial value										
D.F. (tan δ)	≤ 150% of the initial specified value										
ESR	≤ 150% of the initial specified value										
Leakage current	≤ The initial specified value										
Surge Voltage	The capacitors shall be subjected to 1,000 cycles each consisting of charge with the surge voltage specified at 125°C for 30 seconds through a protective resistor(R=1kΩ) and discharge for 5 minutes 30 seconds.										
	<table border="1" style="width: 100%; border-collapse: collapse;"> <tr><td>Appearance</td><td>No significant damage</td></tr> <tr><td>Capacitance change</td><td>≤ ±20% of the initial value</td></tr> <tr><td>D.F. (tan δ)</td><td>≤ 150% of the initial specified value</td></tr> <tr><td>ESR</td><td>≤ 150% of the initial specified value</td></tr> <tr><td>Leakage current</td><td>≤ The initial specified value</td></tr> </table>	Appearance	No significant damage	Capacitance change	≤ ±20% of the initial value	D.F. (tan δ)	≤ 150% of the initial specified value	ESR	≤ 150% of the initial specified value	Leakage current	≤ The initial specified value
Appearance	No significant damage										
Capacitance change	≤ ±20% of the initial value										
D.F. (tan δ)	≤ 150% of the initial specified value										
ESR	≤ 150% of the initial specified value										
Leakage current	≤ The initial specified value										
Failure Rate	0.5% per 1,000 hours maximum (Confidence level 60% at 125°C)										

*Note : If any doubt arises, measure the leakage current after the following voltage treatment.
Voltage treatment : DC rated voltage is applied to the capacitors for 120 minutes at 125°C.

◆ DIMENSIONS [mm]

● Terminal Code : A

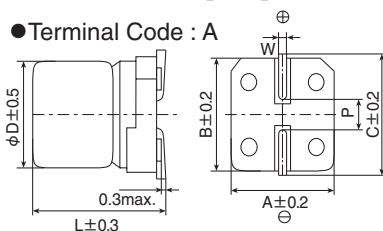

Size code	φD	L	A	B	C	W	P
F60	6.3	5.7	6.6	6.6	7.2	0.5 to 0.8	1.9
H70	8	6.7	8.3	8.3	9.0	0.7 to 1.1	3.1
J80	10	7.7	10.3	10.3	11.0	0.7 to 1.1	4.5

◆ MARKING

EX) 20V22μF



◆ PART NUMBERING SYSTEM

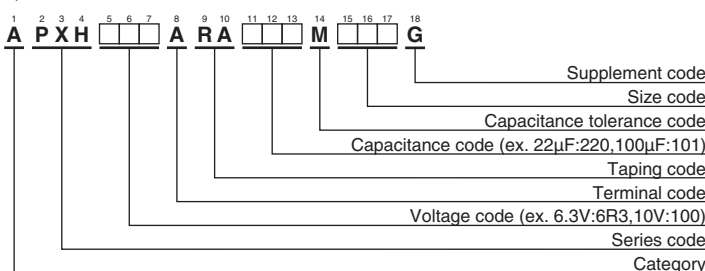

Please refer to "Product code guide (conductive polymer type)"

Return Group Chart



CONDUCTIVE POLYMER ALUMINUM SOLID CAPACITORS

Surface Mount

NPCAP™-PXH Series

◆STANDARD RATINGS

WV (V _{dc})	Cap (μF)	Size code	Leakage current (μA max./after 2min.)	ESR (mΩ max./20°C, 100k to 300kHz)	Rated ripple current (mArms/100kHz)		Part No.
					-55°C ≤ Tx ≤ +105°C ^{*1}	+105°C < Tx ≤ +125°C ^{*1}	
2.5	220	F60	110	35	2,500	770	APXH2R5ARA221MF60G
	560	H70	280	30	3,100	960	APXH2R5ARA561MH70G
	1,000	J80	500	25	3,700	1,100	APXH2R5ARA102MJ80G
4	150	F60	120	35	2,450	770	APXH4R0ARA151MF60G
	220	H70	176	30	3,020	960	APXH4R0ARA221MH70G
	680	J80	544	25	3,700	1,100	APXH4R0ARA681MJ80G
6.3	82	F60	103	40	2,400	720	APXH6R3ARA820MF60G
	100	F60	126	40	2,400	720	APXH6R3ARA101MF60G
	150	H70	189	30	3,020	960	APXH6R3ARA151MH70G
	220	H70	277	30	3,020	960	APXH6R3ARA221MH70G
	470	J80	592	25	3,700	1,100	APXH6R3ARA471MJ80G
10	56	F60	112	45	2,250	680	APXH100ARA560MF60G
	120	H70	240	35	2,800	880	APXH100ARA121MH70G
	150	H70	300	35	2,800	880	APXH100ARA151MH70G
	330	J80	660	30	3,700	1,010	APXH100ARA331MJ80G
16	39	F60	125	50	2,050	650	APXH160ARA390MF60G
	82	H70	262	40	2,700	830	APXH160ARA820MH70G
	150	J80	480	35	3,020	930	APXH160ARA151MJ80G
	180	J80	576	35	3,020	930	APXH160ARA181MJ80G
20	22	F60	88.0	60	1,650	590	APXH200ARA220MF60G
	47	H70	188	45	2,000	780	APXH200ARA470MH70G
	82	J80	328	45	2,400	820	APXH200ARA820MJ80G

*1 Tx : Ambient temperature (°C)

Return Group Chart



CONDUCTIVE POLYMER ALUMINUM SOLID CAPACITORS

Radial Lead

NPCAP™-PSJ Series New!

- Super low ESR, high ripple current capability
- ESR 4mΩ max. lineup
- Endurance : 2,000 hours at 105°C
- Solvent resistant type (see PRECAUTIONS AND GUIDELINES)
- RoHS Compliant
- Halogen Free

PSJ

↑ Lower ESR
PSF P54



◆ SPECIFICATIONS

Items	Characteristics										
Category	-55 to +105°C										
Temperature Range											
Rated Voltage Range	2.5V _{dc}										
Capacitance Tolerance	±20% (M) (at 20°C, 120Hz)										
Surge Voltage	Rated voltage(V) × 1.15 (at 105°C)										
Leakage Current <small>*Note</small>	500μA max. (at 20°C after 2 minutes)										
Dissipation Factor (tan δ)	0.10 max. (at 20°C, 120Hz)										
Low Temperature Characteristics (Max. Impedance Ratio)	Z(-25°C)/Z(+20°C) ≤ 1.15 Z(-55°C)/Z(+20°C) ≤ 1.25 (at 100kHz)										
Endurance	The following specifications shall be satisfied when the capacitors are restored to 20°C after the rated voltage is applied for 5,000 hours (φ 5.4 × 8L : 2,000 hours) at 105°C.										
	<table border="1"> <tr> <td>Appearance</td> <td>No significant damage</td> </tr> <tr> <td>Capacitance change</td> <td>≤ ±20% of the initial value</td> </tr> <tr> <td>D.F. (tan δ)</td> <td>≤ 150% of the initial specified value</td> </tr> <tr> <td>ESR</td> <td>≤ 150% of the initial specified value</td> </tr> <tr> <td>Leakage current</td> <td>≤ The initial specified value</td> </tr> </table>	Appearance	No significant damage	Capacitance change	≤ ±20% of the initial value	D.F. (tan δ)	≤ 150% of the initial specified value	ESR	≤ 150% of the initial specified value	Leakage current	≤ The initial specified value
Appearance	No significant damage										
Capacitance change	≤ ±20% of the initial value										
D.F. (tan δ)	≤ 150% of the initial specified value										
ESR	≤ 150% of the initial specified value										
Leakage current	≤ The initial specified value										
Bias Humidity Test	The following specifications shall be satisfied when the capacitors are restored to 20°C after subjecting them to DC voltage at 60°C, 90 to 95% RH for 1,000 hours.										
	<table border="1"> <tr> <td>Appearance</td> <td>No significant damage</td> </tr> <tr> <td>Capacitance change</td> <td>≤ ±20% of the initial value</td> </tr> <tr> <td>D.F. (tan δ)</td> <td>≤ 150% of the initial specified value</td> </tr> <tr> <td>ESR</td> <td>≤ 150% of the initial specified value</td> </tr> <tr> <td>Leakage current</td> <td>≤ The initial specified value</td> </tr> </table>	Appearance	No significant damage	Capacitance change	≤ ±20% of the initial value	D.F. (tan δ)	≤ 150% of the initial specified value	ESR	≤ 150% of the initial specified value	Leakage current	≤ The initial specified value
Appearance	No significant damage										
Capacitance change	≤ ±20% of the initial value										
D.F. (tan δ)	≤ 150% of the initial specified value										
ESR	≤ 150% of the initial specified value										
Leakage current	≤ The initial specified value										
Surge Voltage Test	The capacitors shall be subjected to 1,000 cycles each consisting of charge with the surge voltage specified at 105°C for 30 seconds through a protective resistor(R=1kΩ) and discharge for 5 minutes 30 seconds.										
	<table border="1"> <tr> <td>Appearance</td> <td>No significant damage</td> </tr> <tr> <td>Capacitance change</td> <td>≤ ±20% of the initial value</td> </tr> <tr> <td>D.F. (tan δ)</td> <td>≤ 150% of the initial specified value</td> </tr> <tr> <td>ESR</td> <td>≤ 150% of the initial specified value</td> </tr> <tr> <td>Leakage current</td> <td>≤ The initial specified value</td> </tr> </table>	Appearance	No significant damage	Capacitance change	≤ ±20% of the initial value	D.F. (tan δ)	≤ 150% of the initial specified value	ESR	≤ 150% of the initial specified value	Leakage current	≤ The initial specified value
Appearance	No significant damage										
Capacitance change	≤ ±20% of the initial value										
D.F. (tan δ)	≤ 150% of the initial specified value										
ESR	≤ 150% of the initial specified value										
Leakage current	≤ The initial specified value										
Failure Rate	0.5% per 1,000 hours maximum (Confidence level 60% at 105°C)										

*Note : If any doubt arises, measure the leakage current after the following voltage treatment.
Voltage treatment : DC rated voltage is applied to the capacitors for 120 minutes at 105°C.

◆ DIMENSIONS [mm]

- Terminal Code : E

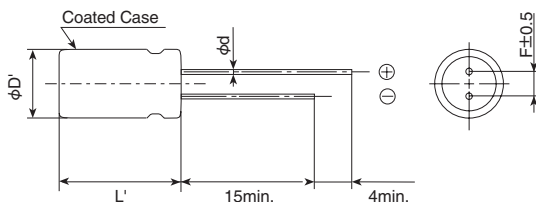

Size code	E08	F08
φD	5.4	6.3
φd	0.6	0.6
F	2.0	2.5
φD'	φD+0.5max.	
L'	L+1.5max.	

◆ MARKING

EX) 2.5V560μF



Return Group Chart



CONDUCTIVE POLYMER ALUMINUM SOLID CAPACITORS

Radial Lead

NPCAP™-PSJ ^{New!} Series

◆PART NUMBERING SYSTEM

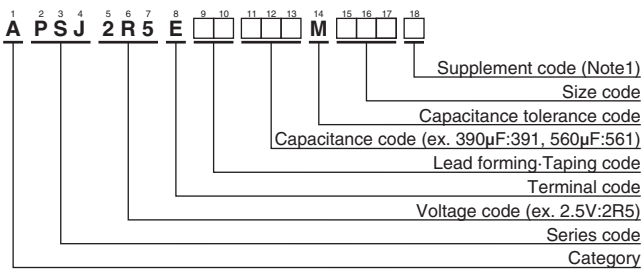

(Note1) : PSJ series, 2.5V560µF (ESR 4mΩ max.) has supplement code "J".
Terminal and terminal plating are the same as all other in PSJ series.

Please refer to "Product code guide (conductive polymer type)"

◆STANDARD RATINGS

WV (V _{dc})	Cap (µF)	Case size φD×L(mm)	ESR (mΩ max./20°C, 300kHz)	Rated ripple current (mA _{rms} /105°C, 100kHz)	Part No.
2.5	390	5.4 × 8	4	5,600	APSJ2R5E□□391ME08S
	470	5.4 × 8	4.5	5,200	APSJ2R5E□□471ME08S
	560	6.3 × 8	4	6,500	APSJ2R5E□□561MF08J
	560	6.3 × 8	4.5	6,200	APSJ2R5E□□561MF08S

□□ : Enter the appropriate lead forming or taping code.

Return Group Chart



CONDUCTIVE POLYMER ALUMINUM SOLID CAPACITORS

Radial Lead

NPCAP™-PSG Series Upgrade!

- Super low ESR, high ripple current capability
- Added 35V
- Endurance: 15,000 to 20,000 hours at 105°C
- Rated voltage : 16 to 35V_{dc}
- RoHS Compliant
- Halogen Free

PSG

↓
Downsized
PSF P54



◆ SPECIFICATIONS

Items	Characteristics										
Category	-55 to +105°C										
Temperature Range											
Rated Voltage	16 to 35V _{dc}										
Capacitance Tolerance	±20% (M) (at 20°C, 120Hz)										
Surge Voltage	Rated voltage(V) × 1.15 (at 105°C)										
Leakage Current <small>*Note</small>	I=0.2CV or 500μA, whichever is greater Where, I : Leakage current (μA), C : Nominal capacitance (μF), V : Rated voltage (V) (at 20°C after 2 minutes)										
Dissipation Factor (tan δ)	0.12 max. (at 20°C, 120Hz)										
Low Temperature Characteristics (Max.Impedance Ratio)	Z(-25°C)/Z(+20°C) ≤ 1.15 Z(-55°C)/Z(+20°C) ≤ 1.25 (at 100kHz)										
Endurance	The following specifications shall be satisfied when the capacitors are restored to 20°C after the rated voltage is applied for 20,000 hours (20 to 35V : 15,000 hours) at 105°C.										
	<table border="1"> <tr><td>Appearance</td><td>No significant damage</td></tr> <tr><td>Capacitance change</td><td>≤ ±20% of the initial value</td></tr> <tr><td>D.F. (tan δ)</td><td>≤ 150% of the initial specified value</td></tr> <tr><td>ESR</td><td>≤ 150% of the initial specified value</td></tr> <tr><td>Leakage current</td><td>≤ The initial specified value</td></tr> </table>	Appearance	No significant damage	Capacitance change	≤ ±20% of the initial value	D.F. (tan δ)	≤ 150% of the initial specified value	ESR	≤ 150% of the initial specified value	Leakage current	≤ The initial specified value
Appearance	No significant damage										
Capacitance change	≤ ±20% of the initial value										
D.F. (tan δ)	≤ 150% of the initial specified value										
ESR	≤ 150% of the initial specified value										
Leakage current	≤ The initial specified value										
Bias Humidity Test	The following specifications shall be satisfied when the capacitors are restored to 20°C after subjecting them to DC voltage at 60°C, 90 to 95% RH for 1,000 hours.										
	<table border="1"> <tr><td>Appearance</td><td>No significant damage</td></tr> <tr><td>Capacitance change</td><td>≤ ±20% of the initial value</td></tr> <tr><td>D.F. (tan δ)</td><td>≤ The initial specified value</td></tr> <tr><td>ESR</td><td>≤ 150% of the initial specified value</td></tr> <tr><td>Leakage current</td><td>≤ The initial specified value</td></tr> </table>	Appearance	No significant damage	Capacitance change	≤ ±20% of the initial value	D.F. (tan δ)	≤ The initial specified value	ESR	≤ 150% of the initial specified value	Leakage current	≤ The initial specified value
Appearance	No significant damage										
Capacitance change	≤ ±20% of the initial value										
D.F. (tan δ)	≤ The initial specified value										
ESR	≤ 150% of the initial specified value										
Leakage current	≤ The initial specified value										
Surge Voltage Test	The capacitors shall be subjected to 1,000 cycles each consisting of charge with the surge voltage specified at 105°C for 30 seconds through a protective resistor(R=1kΩ) and discharge for 5 minutes 30 seconds.										
	<table border="1"> <tr><td>Appearance</td><td>No significant damage</td></tr> <tr><td>Capacitance change</td><td>≤ ±20% of the initial value</td></tr> <tr><td>D.F. (tan δ)</td><td>≤ The initial specified value</td></tr> <tr><td>ESR</td><td>≤ 150% of the initial specified value</td></tr> <tr><td>Leakage current</td><td>≤ The initial specified value</td></tr> </table>	Appearance	No significant damage	Capacitance change	≤ ±20% of the initial value	D.F. (tan δ)	≤ The initial specified value	ESR	≤ 150% of the initial specified value	Leakage current	≤ The initial specified value
Appearance	No significant damage										
Capacitance change	≤ ±20% of the initial value										
D.F. (tan δ)	≤ The initial specified value										
ESR	≤ 150% of the initial specified value										
Leakage current	≤ The initial specified value										
Failure Rate	0.5% per 1,000 hours maximum (Confidence level 60% at 105°C)										

*Note : If any doubt arises, measure the leakage current after the following voltage treatment.
Voltage treatment : DC rated voltage is applied to the capacitors for 120 minutes at 105°C.

◆ DIMENSIONS [mm]

- Terminal Code : E

F05,F08,H06,H08

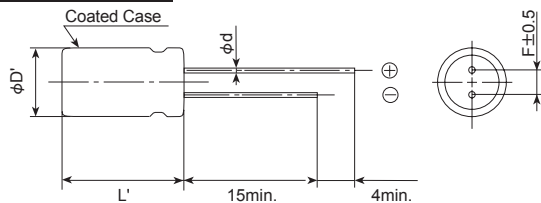

Size code	F05	F08	H06	H08	HB5	H16	H20	JB5	J16	J20
φD	6.3		8.0			10.0				
φd	0.45		0.6			1.0				
F	2.5		3.5			5.0				
φD'			φD+0.5max.							
L'	L+1.0max. (Note1)				L+1.5max.					

Note1 : L+1.2 max. for 16V270μF (Rated ripple current 5,080mArms).

HB5,H16,H20,JB5,J16,J20

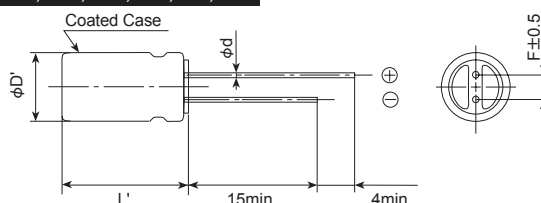

◆ MARKING

EX) 16V150μF



Return Group Chart



CONDUCTIVE POLYMER ALUMINUM SOLID CAPACITORS

Radial Lead

NPCAP™-PSG Series Upgrade!

◆PART NUMBERING SYSTEM

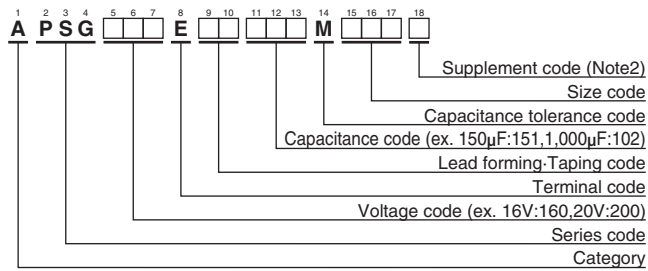

(Note2) : PSG series, 16V270 μ F (Rated ripple current 5,080mArms) ,16V470 μ F (Rated ripple current 5,400mArms) ,16V560 μ F (Rated ripple current 6,100mArms) have supplement code "J". Terminal and terminal plating are the same as all other in PSG series.

Please refer to "Product code guide (conductive polymer type)"

◆STANDARD RATINGS

WV (V _{dc})	Cap (μ F)	Case size ϕ D \times L (mm)	ESR (m Ω max./20°C, 100k to 300kHz)	Rated ripple current (mArms/105°C, 100kHz)	Part No.
16	150	6.3 \times 5	20	3,200	APSG160E□□151MF05S
	270	6.3 \times 8	10	5,080	APSG160E□□271MF08J
	270	6.3 \times 8	15	3,800	APSG160E□□271MF08S
	270	8 \times 6	22	3,300	APSG160E□□271MH06S
	470	8 \times 8	8	5,400	APSG160E□□471MH08J
	470	8 \times 8	16	4,000	APSG160E□□471MH08S
	560	8 \times 11.5	8	6,100	APSG160E□□561MHB5J
	560	8 \times 11.5	14	4,970	APSG160E□□561MHB5S
	820	8 \times 16	8	7,000	APSG160E□□821MH16S
	820	10 \times 11.5	12	5,400	APSG160E□□821MJB5S
	1,000	8 \times 20	8	7,500	APSG160E□□102MH20S
	1,000	10 \times 11.5	12	5,400	APSG160E□□102MJB5S
	1,200	8 \times 20	8	7,500	APSG160E□□122MH20S
	1,500	10 \times 16	8	7,700	APSG160E□□152MJ16S
1,800	10 \times 20	8	8,100	APSG160E□□182MJ20S	
2,200	10 \times 20	8	8,100	APSG160E□□222MJ20S	
20	120	6.3 \times 5	20	3,200	APSG200E□□121MF05S
	180	6.3 \times 8	18	3,460	APSG200E□□181MF08S
	330	8 \times 8	17	3,880	APSG200E□□331MH08S
	390	8 \times 11.5	14	4,970	APSG200E□□391MHB5S
	680	10 \times 11.5	12	5,400	APSG200E□□681MJB5S
25	56	6.3 \times 5	30	2,600	APSG250E□□560MF05S
	82	6.3 \times 8	28	2,780	APSG250E□□820MF08S
	180	8 \times 8	18	3,770	APSG250E□□181MH08S
	180	8 \times 11.5	16	4,650	APSG250E□□181MHB5S
	220	8 \times 11.5	16	4,650	APSG250E□□221MHB5S
	330	10 \times 11.5	14	5,000	APSG250E□□331MJB5S
35	390	10 \times 11.5	14	5,000	APSG250E□□391MJB5S
	68	8 \times 11.5	18	4,380	APSG350E□□680MHB5S
	120	10 \times 11.5	16	4,670	APSG350E□□121MJB5S

□□ : Enter the appropriate lead forming or taping code.



NPCAP™-PSK Series

- Super low ESR, high ripple current capability
- Downsized from PSE series (φ 6.3x8L to φ 5x8L)
- Long life (20,000 hours at 105°C)
- Solvent resistant type (see PRECAUTIONS AND GUIDELINES)
- RoHS Compliant
- Halogen Free



◆ SPECIFICATIONS

Items	Characteristics										
Category	-55 to +105°C										
Temperature Range											
Rated Voltage Range	2.5 to 6.3 V _{dc}										
Capacitance Tolerance	±20% (M) (at 20°C, 120Hz)										
Surge Voltage	Rated voltage(V) × 1.15 (at 105°C)										
Leakage Current*Note	500μA max. (at 20°C after 2 minutes)										
Dissipation Factor (tan δ)	0.10 max. (at 20°C, 120Hz)										
Low Temperature Characteristics (Max.Impedance Ratio)	Z(-25°C)/Z(+20°C) ≤ 1.15 Z(-55°C)/Z(+20°C) ≤ 1.25 (at 100kHz)										
Endurance	The following specifications shall be satisfied when the capacitors are restored to 20°C after the rated voltage is applied for 20,000 hours at 105°C.										
	<table border="1" style="width: 100%; border-collapse: collapse;"> <tr> <td>Appearance</td> <td>No significant damage</td> </tr> <tr> <td>Capacitance change</td> <td>≤ ±20% of the initial value</td> </tr> <tr> <td>D.F. (tan δ)</td> <td>≤ 150% of the initial specified value</td> </tr> <tr> <td>ESR</td> <td>≤ 150% of the initial specified value</td> </tr> <tr> <td>Leakage current</td> <td>≤ The initial specified value</td> </tr> </table>	Appearance	No significant damage	Capacitance change	≤ ±20% of the initial value	D.F. (tan δ)	≤ 150% of the initial specified value	ESR	≤ 150% of the initial specified value	Leakage current	≤ The initial specified value
Appearance	No significant damage										
Capacitance change	≤ ±20% of the initial value										
D.F. (tan δ)	≤ 150% of the initial specified value										
ESR	≤ 150% of the initial specified value										
Leakage current	≤ The initial specified value										
Bias Humidity Test	The following specifications shall be satisfied when the capacitors are restored to 20°C after subjecting them to DC voltage at 60°C, 90 to 95% RH for 1,000 hours.										
	<table border="1" style="width: 100%; border-collapse: collapse;"> <tr> <td>Appearance</td> <td>No significant damage</td> </tr> <tr> <td>Capacitance change</td> <td>≤ ±20% of the initial value</td> </tr> <tr> <td>D.F. (tan δ)</td> <td>≤ The initial specified value</td> </tr> <tr> <td>ESR</td> <td>≤ The initial specified value</td> </tr> <tr> <td>Leakage current</td> <td>≤ The initial specified value</td> </tr> </table>	Appearance	No significant damage	Capacitance change	≤ ±20% of the initial value	D.F. (tan δ)	≤ The initial specified value	ESR	≤ The initial specified value	Leakage current	≤ The initial specified value
Appearance	No significant damage										
Capacitance change	≤ ±20% of the initial value										
D.F. (tan δ)	≤ The initial specified value										
ESR	≤ The initial specified value										
Leakage current	≤ The initial specified value										
Surge Voltage Test	The capacitors shall be subjected to 1,000 cycles each consisting of charge with the surge voltage specified at 105°C for 30 seconds through a protective resistor(R=1kΩ) and discharge for 5 minutes 30 seconds.										
	<table border="1" style="width: 100%; border-collapse: collapse;"> <tr> <td>Appearance</td> <td>No significant damage</td> </tr> <tr> <td>Capacitance change</td> <td>≤ ±20% of the initial value</td> </tr> <tr> <td>D.F. (tan δ)</td> <td>≤ The initial specified value</td> </tr> <tr> <td>ESR</td> <td>≤ The initial specified value</td> </tr> <tr> <td>Leakage current</td> <td>≤ The initial specified value</td> </tr> </table>	Appearance	No significant damage	Capacitance change	≤ ±20% of the initial value	D.F. (tan δ)	≤ The initial specified value	ESR	≤ The initial specified value	Leakage current	≤ The initial specified value
Appearance	No significant damage										
Capacitance change	≤ ±20% of the initial value										
D.F. (tan δ)	≤ The initial specified value										
ESR	≤ The initial specified value										
Leakage current	≤ The initial specified value										
Failure Rate	0.5% per 1,000 hours maximum (Confidence level 60% at 105°C)										

*Note : If any doubt arises, measure the leakage current after the following voltage treatment.
Voltage treatment : DC rated voltage is applied to the capacitors for 120 minutes at 105°C.

◆ DIMENSIONS [mm]

● Terminal Code : E

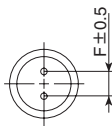
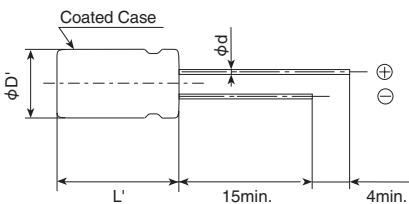

Size code	E08
φD	5.0
φd	0.5(Note2)
F	2.0
φD'	φD+0.5max.
L'	L+1.0max.

Note2 : 0.45 for rated voltage 2.5V

◆ MARKING

EX) 2.5V560μF





NPCAP™-PSK Series

◆PART NUMBERING SYSTEM

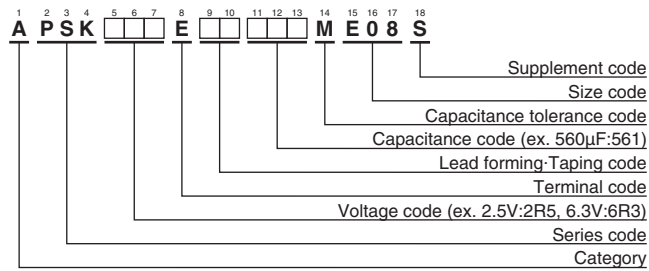

Please refer to "Product code guide (conductive polymer type)"

◆STANDARD RATINGS

WV (V _{dc})	Cap (μF)	Case size φD×L (mm)	ESR (mΩ max./20°C, 100k to 300kHz)	Rated ripple current (mA _{rms} /105°C, 100kHz)	Part No.
2.5	220	5 × 8	7	4,350	APSK2R5E□□221ME08S
	330	5 × 8	7	4,350	APSK2R5E□□331ME08S
	470	5 × 8	7	4,350	APSK2R5E□□471ME08S
	560	5 × 8	7	4,350	APSK2R5E□□561ME08S
4	330	5 × 8	8	4,050	APSK4R0E□□331ME08S
6.3	270	5 × 8	10	3,700	APSK6R3E□□271ME08S
	330	5 × 8	8	4,050	APSK6R3E□□331ME08S

□□ : Enter the appropriate lead forming or taping code.

Return Group Chart



CONDUCTIVE POLYMER ALUMINUM SOLID CAPACITORS

Radial Lead

NPCAP™-PSF Series

- Super low ESR, high ripple current capability
- ESR 5mΩmax. (2 to 4V_{dc})
- Longer life (20,000 hours at 105°C)
- Rated voltage range : 2 to 16V_{dc}
- Solvent resistant type (see PRECAUTIONS AND GUIDELINES)
- RoHS Compliant
- Halogen Free

PSF

↑ Lower ESR
PSE P56



◆ SPECIFICATIONS

Items	Characteristics
Category	
Temperature Range	-55 to +105°C
Rated Voltage Range	2 to 16V _{dc}
Capacitance Tolerance	±20%(M) (at 20°C, 120Hz)
Surge Voltage	Rated voltage(V) × 1.15 (at 105°C)
Leakage Current *Note	Shall not exceed values shown in STANDARD RATINGS. (at 20°C after 2 minutes)
Dissipation Factor (tan δ)	0.10 max. (at 20°C, 120Hz)
Low Temperature Characteristics (Max.Impedance Ratio)	Z(-25°C)/Z(+20°C) ≤ 1.15 Z(-55°C)/Z(+20°C) ≤ 1.25 (at 100kHz)
Endurance	The following specifications shall be satisfied when the capacitors are restored to 20°C after the rated voltage is applied for 20,000 hours at 105°C.
Appearance	No significant damage
Capacitance change	≤ ±20% of the initial value
D.F. (tan δ)	≤ 150% of the initial specified value
ESR	≤ 150% of the initial specified value
Leakage current	≤ The initial specified value
Bias Humidity Test	The following specifications shall be satisfied when the capacitors are restored to 20°C after subjecting them to DC voltage at 60°C, 90 to 95% RH for 1,000 hours.
Appearance	No significant damage
Capacitance change	≤ ±20% of the initial value
D.F. (tan δ)	≤ The initial specified value
ESR	2 to 6.3V _{dc} : ≤ The initial specified value 16V _{dc} : ≤ 150% of the initial specified value
Leakage current	≤ The initial specified value
Surge Voltage Test	The capacitors shall be subjected to 1,000 cycles each consisting of charge with the surge voltage specified at 105°C for 30 seconds through a protective resistor(R=1kΩ) and discharge for 5 minutes 30 seconds.
Appearance	No significant damage
Capacitance change	≤ ±20% of the initial value
D.F. (tan δ)	≤ The initial specified value
ESR	2 to 6.3V _{dc} : ≤ The initial specified value 16V _{dc} : ≤ 150% of the initial specified value
Leakage current	≤ The initial specified value
Failure Rate	0.5% per 1,000 hours maximum (Confidence level 60% at 105°C)

*Note : If any doubt arises, measure the leakage current after the following voltage treatment.
Voltage treatment : DC rated voltage is applied to the capacitors for 120 minutes at 105°C.

◆ DIMENSIONS [mm]

● Terminal Code : E

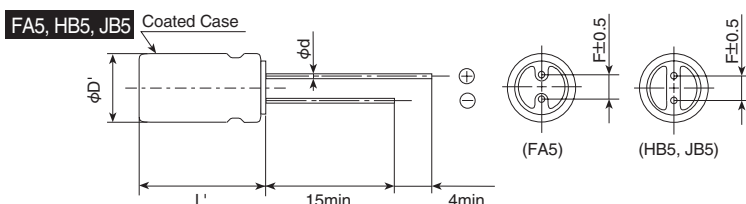
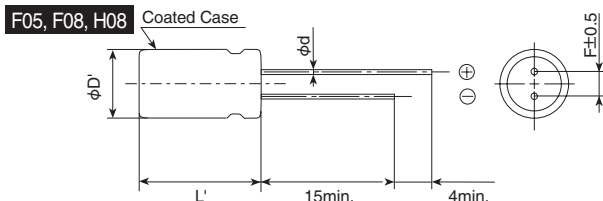

Size code	F05	F08	FA5	H08	HB5	JB5
φD		6.3		8.0	10.0	
φd	0.45	0.6	0.5		0.6	
F		2.5		3.5	5.0	
φD'	φD+0.5max.					
L'	L+1.0max. (Note1)	L+0.3max.	L+1.0max.		L+1.5max.	

Note1 : L+1.2 max. for 6.3V820μF

◆ MARKING

EX) 2.5V560μF





NPCAP™-PSF Series

◆PART NUMBERING SYSTEM

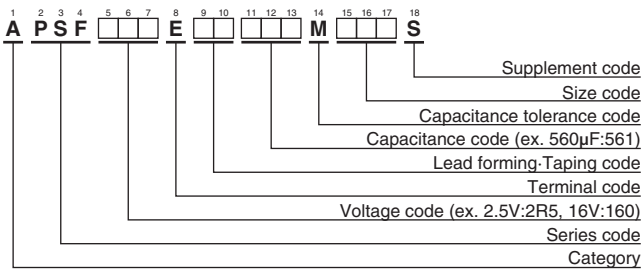

Please refer to "Product code guide (conductive polymer type)"

◆STANDARD RATINGS

WV (V _{dc})	Cap (μF)	Case size φD×L(mm)	Leakage current (μA max./after 2min.)	ESR (mΩ max./20°C, 100k to 300kHz)	Rated ripple current (mArms/105°C, 100kHz)	Part No.
2	1,000	6.3×8	500	5	5,900	APSF2R0E□□102MF08S
	330	6.3×8	500	5	5,900	APSF2R5E□□331MF08S
2.5	470	6.3×8	500	5	5,900	APSF2R5E□□471MF08S
	560	6.3×8	500	5	5,900	APSF2R5E□□561MF08S
	820	6.3×8	500	5	5,900	APSF2R5E□□821MF08S
	1,200	6.3×8	1,200	5	5,900	APSF2R5E□□122MF08S
	1,600	8×8	800	5	6,100	APSF2R5E□□162MH08S
	470	6.3×8	500	5	5,900	APSF4R0E□□471MF08S
4	560	6.3×8	500	5	5,900	APSF4R0E□□561MF08S
	820	6.3×8	1,030	8	4,700	APSF6R3E□□821MF08S
6.3	100	6.3×5	500	24	2,490	APSF160E□□101MF05S
	100	6.3×10.5	500	25	2,820	APSF160E□□101MFA5S
	270	8×8	864	10	5,000	APSF160E□□271MH08S
	270	8×11.5	864	11	5,080	APSF160E□□271MHB5S
	330	8×8	1,050	13	4,700	APSF160E□□331MH08S
	470	8×11.5	1,500	11	5,400	APSF160E□□471MHB5S
	470	10×11.5	1,500	10	6,100	APSF160E□□471MJB5S

□□ : Enter the appropriate lead forming or taping code.

Return Group Chart



CONDUCTIVE POLYMER ALUMINUM SOLID CAPACITORS

Radial Lead

NPCAP™-PSE Series

- Super low ESR, high ripple current capability
- Downsized from PSC series (φ 8×8L to φ 6.3×8L)
- Endurance is longer than PSC series (20,000 hours at 105°C)
- Rated voltage range : 2.5 to 6.3V_{dc}
- Solvent resistant type (see PRECAUTIONS AND GUIDELINES)
- RoHS Compliant
- Halogen Free

PSE

↑ Longer life
Downsized
PSC P58



◆ SPECIFICATIONS

Items	Characteristics										
Category	-55 to +105°C										
Temperature Range											
Rated Voltage Range	2.5 to 6.3V _{dc}										
Capacitance Tolerance	±20% (M) (at 20°C, 120Hz)										
Surge Voltage	Rated voltage(V) × 1.15 (at 105°C)										
Leakage Current *Note	I=0.2CV or 500μA, whichever is greater Where, I : Max. leakage current (μA), C : Nominal capacitance (μF), V : Rated voltage (V) (at 20°C after 2 minutes)										
Dissipation Factor (tan δ)	0.10 max. (at 20°C, 120Hz)										
Low Temperature Characteristics (Max.Impedance Ratio)	Z(-25°C)/Z(+20°C) ≤ 1.15 Z(-55°C)/Z(+20°C) ≤ 1.25 (at 100kHz)										
Endurance	The following specifications shall be satisfied when the capacitors are restored to 20°C after the rated voltage is applied for 20,000 hours at 105°C.										
	<table border="1"> <tr> <td>Appearance</td> <td>No significant damage</td> </tr> <tr> <td>Capacitance change</td> <td>≤ ±20% of the initial value</td> </tr> <tr> <td>D.F. (tan δ)</td> <td>≤ 150% of the initial specified value</td> </tr> <tr> <td>ESR</td> <td>≤ 200% of the initial specified value</td> </tr> <tr> <td>Leakage current</td> <td>≤ The initial specified value</td> </tr> </table>	Appearance	No significant damage	Capacitance change	≤ ±20% of the initial value	D.F. (tan δ)	≤ 150% of the initial specified value	ESR	≤ 200% of the initial specified value	Leakage current	≤ The initial specified value
Appearance	No significant damage										
Capacitance change	≤ ±20% of the initial value										
D.F. (tan δ)	≤ 150% of the initial specified value										
ESR	≤ 200% of the initial specified value										
Leakage current	≤ The initial specified value										
Bias Humidity Test	The following specifications shall be satisfied when the capacitors are restored to 20°C after subjecting them to DC voltage at 60°C, 90 to 95% RH for 1,000 hours.										
	<table border="1"> <tr> <td>Appearance</td> <td>No significant damage</td> </tr> <tr> <td>Capacitance change</td> <td>≤ ±20% of the initial value</td> </tr> <tr> <td>D.F. (tan δ)</td> <td>≤ The initial specified value</td> </tr> <tr> <td>ESR</td> <td>≤ The initial specified value</td> </tr> <tr> <td>Leakage current</td> <td>≤ The initial specified value</td> </tr> </table>	Appearance	No significant damage	Capacitance change	≤ ±20% of the initial value	D.F. (tan δ)	≤ The initial specified value	ESR	≤ The initial specified value	Leakage current	≤ The initial specified value
Appearance	No significant damage										
Capacitance change	≤ ±20% of the initial value										
D.F. (tan δ)	≤ The initial specified value										
ESR	≤ The initial specified value										
Leakage current	≤ The initial specified value										
Surge Voltage Test	The capacitors shall be subjected to 1,000 cycles each consisting of charge with the surge voltage specified at 105°C for 30 seconds through a protective resistor(R=1kΩ) and discharge for 5 minutes 30 seconds.										
	<table border="1"> <tr> <td>Appearance</td> <td>No significant damage</td> </tr> <tr> <td>Capacitance change</td> <td>≤ ±20% of the initial value</td> </tr> <tr> <td>D.F. (tan δ)</td> <td>≤ The initial specified value</td> </tr> <tr> <td>ESR</td> <td>≤ The initial specified value</td> </tr> <tr> <td>Leakage current</td> <td>≤ The initial specified value</td> </tr> </table>	Appearance	No significant damage	Capacitance change	≤ ±20% of the initial value	D.F. (tan δ)	≤ The initial specified value	ESR	≤ The initial specified value	Leakage current	≤ The initial specified value
Appearance	No significant damage										
Capacitance change	≤ ±20% of the initial value										
D.F. (tan δ)	≤ The initial specified value										
ESR	≤ The initial specified value										
Leakage current	≤ The initial specified value										
Failure Rate	0.5% per 1,000 hours maximum (Confidence level 60% at 105°C)										

*Note : If any doubt arises, measure the leakage current after the following voltage treatment.
Voltage treatment : DC rated voltage is applied to the capacitors for 120 minutes at 105°C.

◆ DIMENSIONS [mm]

● Terminal Code : E

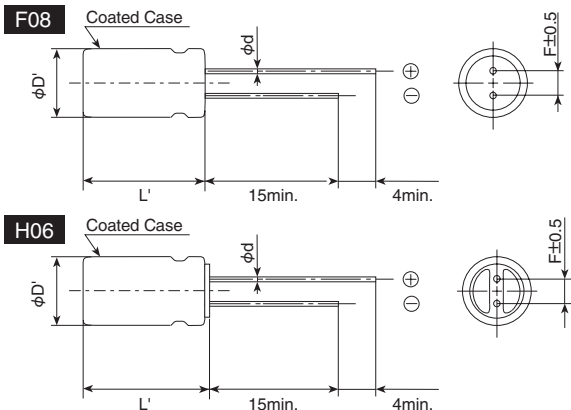

Size code	F08	H06
φD	6.3	8.0
φd	0.6	
F	2.5	3.5
φD'	φD+0.5max.	
L'	L+1.5max.	

◆ MARKING

EX) 2.5V820μF





NPCAP™-PSE Series

◆PART NUMBERING SYSTEM

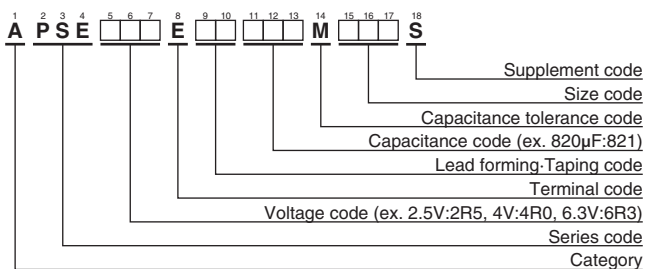

Please refer to "Product code guide (conductive polymer type)"

◆STANDARD RATINGS

WV (V _{dc})	Cap (µF)	Case size φ D×L(mm)	ESR (mΩ max./20°C, 100k to 300kHz)	Rated ripple current (mA _{rms} /105°C, 100kHz)	Part No.
2.5	680	8 × 6	8	4,900	APSE2R5E□□681MH06S
	820	6.3 × 8	7	5,000	APSE2R5E□□821MF08S
4	560	6.3 × 8	7	5,000	APSE4R0E□□561MF08S
6.3	470	6.3 × 8	8	4,700	APSE6R3E□□471MF08S
	560	6.3 × 8	8	4,700	APSE6R3E□□561MF08S

□□ : Enter the appropriate lead forming or taping code.



NPCAP™-PSC Series

- Super low ESR, high ripple current capability
- Lower profile than PSA ($\phi 8 \times 8L$ to $\phi 10 \times 12.5L$)
- Rated voltage range : 2.5 to 16V_{dc}
- Nominal capacitance range : 270 to 2,700 μ F
- Endurance : 15,000 hours at 105°C
- Suitable for DC-DC converters, voltage regulators and decoupling applications for computer motherboards
- Added 2.5V 820 μ F (ESR 5m Ω max.)
- Solvent resistant type (see PRECAUTIONS AND GUIDELINES)
- RoHS Compliant
- Halogen Free

PSC

↑
Low profile
Lower ESR
PSA P60



◆ SPECIFICATIONS

Items	Characteristics
Category Temperature Range	-55 to +105°C
Rated Voltage Range	2.5 to 16V _{dc}
Capacitance Tolerance	$\pm 20\%$ (M) (at 20°C, 120Hz)
Surge Voltage	Rated voltage $\times 1.15$ (at 105°C)
Leakage Current <small>*Note</small>	$I=0.2CV$ or 500 μ A, whichever is greater. Where, I : Max. leakage current (μ A), C : Nominal capacitance (μ F), V : Rated voltage (V _{dc}) (at 20°C after 2 minutes)
Dissipation Factor (tan δ)	0.10 max. (at 20°C, 120Hz)
Low Temperature Characteristics (Max.Impedance Ratio)	$Z(-25^\circ\text{C})/Z(+20^\circ\text{C}) \leq 1.15$ $Z(-55^\circ\text{C})/Z(+20^\circ\text{C}) \leq 1.25$ (at 100kHz)
Endurance	The following specifications shall be satisfied when the capacitors are restored to 20°C after the rated voltage is applied for 15,000 hours at 105°C.
Appearance	No significant damage
Capacitance change	$\leq \pm 20\%$ of the initial value
D.F. (tan δ)	$\leq 150\%$ of the initial specified value
ESR	$\leq 150\%$ of the initial specified value
Leakage current	\leq The initial specified value
Bias Humidity Test	The following specifications shall be satisfied when the capacitors are restored to 20°C after subjecting them to DC voltage at 60°C, 90 to 95% RH for 1,000 hours.
Appearance	No significant damage
Capacitance change	$\leq \pm 20\%$ of the initial value
D.F. (tan δ)	$\leq 150\%$ of the initial specified value
ESR	$\leq 150\%$ of the initial specified value
Leakage current	\leq The initial specified value
Surge Voltage Test	The capacitors shall be subjected to 1,000 cycles each consisting of charge with the surge voltage specified at 105°C for 30 seconds through a protective resistor(R=1k Ω) and discharge for 5 minutes 30 seconds.
Appearance	No significant damage
Capacitance change	$\leq \pm 20\%$ of the initial value
D.F. (tan δ)	$\leq 150\%$ of the initial specified value
ESR	$\leq 150\%$ of the initial specified value
Leakage current	\leq The initial specified value
Failure Rate	0.5% per 1,000 hours maximum (Confidence level 60% at 105°C)

*Note : If any doubt arises, measure the leakage current after the following voltage treatment.
Voltage treatment : DC rated voltage is applied to the capacitors for 120 minutes at 105°C.

◆ DIMENSIONS [mm]

● Terminal Code : E

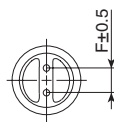
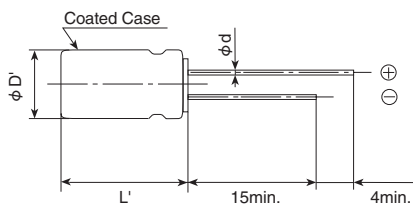

Size code	H08	HB5	JB5	JC5
ϕD	8.0	8.0	10.0	10.0
ϕd	0.6	0.8(Note1)	0.8(Note1)	0.6
F	3.5	3.5	5.0	5.0
$\phi D'$	$\phi D+0.5\text{max.}$			
L'	L+1.0max.		L+1.5max.	

Note 1 : 0.6 for rated volt 16V.

◆ MARKING

EX) 2.5V820 μ F





NPCAP™-PSC Series

◆PART NUMBERING SYSTEM

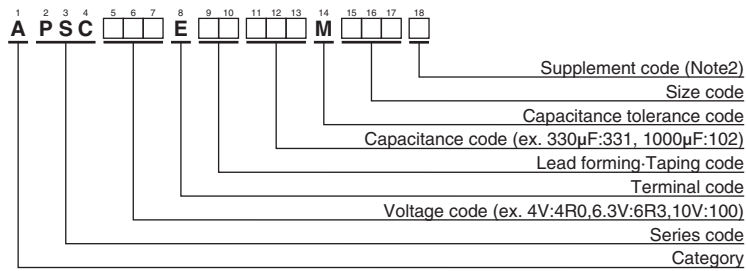

(Note2) PSC series, 2.5V820μF(ESR 5mΩ max.) has supplement code "J".
 Can case, terminal and terminal plating are the same as all others in PSC series.

Please refer to "Product code guide (conductive polymer type)"

◆STANDARD RATINGS

WV (V _{dc})	Cap (μF)	Case size φ D×L(mm)	ESR (mΩ max./20°C, 100k to 300kHz)	Rated ripple current (mArms/105°C, 100kHz)	Part No.
2.5	560	8×8	7	6,100	APSC2R5E□□561MH08S
	820	8×8	5	6,100	APSC2R5E□□821MH08J
	820	8×8	7	6,100	APSC2R5E□□821MH08S
	1,000	8×8	7	6,100	APSC2R5E□□102MH08S
	1,000	8×11.5	7	6,100	APSC2R5E□□102MHB5S
	1,500	8×11.5	7	6,100	APSC2R5E□□152MHB5S
4	2,700	10×11.5	8	5,560	APSC2R5E□□272MJB5S
	560	8×8	7	6,100	APSC4R0E□□561MH08S
	680	8×11.5	7	6,100	APSC4R0E□□681MHB5S
6.3	1,000	10×11.5	6	6,640	APSC4R0E□□102MJB5S
	470	8×8	8	5,700	APSC6R3E□□471MH08S
	560	8×8	8	5,700	APSC6R3E□□561MH08S
	820	10×11.5	7	6,640	APSC6R3E□□821MJB5S
10	1,500	10×11.5	10	5,560	APSC6R3E□□152MJB5S
	390	8×11.5	9	5,650	APSC100E□□391MHB5S
16	680	10×11.5	7	6,100	APSC100E□□681MJB5S
	270	8×11.5	11	5,080	APSC160E□□271MHB5S
	330	10×11.5	10	6,100	APSC160E□□331MJB5S
	330	10×12.5	10	6,100	APSC160E□□331MJC5S
	470	10×11.5	10	6,100	APSC160E□□471MJB5S

□□ : Enter the appropriate lead forming or taping code.



NPCAP™-PSA Series

- Super low ESR, high temperature resistance and high ripple current capability
- Rated voltage range : 2.5 to 16V_{dc}
- Endurance : 15,000 hours at 105°C
- Suitable for DC-DC converters, voltage regulators and decoupling applications for computer motherboards
- Solvent resistant type (see PRECAUTIONS AND GUIDELINES)
- RoHS Compliant
- Halogen Free

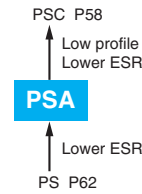

◆ SPECIFICATIONS

Items	Characteristics										
Category	-55 to +105°C										
Temperature Range	-55 to +105°C										
Rated Voltage Range	2.5 to 16V _{dc}										
Capacitance Tolerance	±20% (M) (at 20°C, 120Hz)										
Surge Voltage	Rated voltage × 1.15 (at 105°C)										
Leakage Current	I=0.2CV (at 20°C after 2 minutes)										
<small>*Note</small>	Where, I : Max. leakage current (μA), C : Nominal capacitance (μF), V : Rated voltage (V _{dc})										
Dissipation Factor (tan δ)	0.08 max. (FA5 size : 0.12max.) (at 20°C, 120Hz)										
Low Temperature Characteristics (Max. Impedance Ratio)	Z(-25°C)/Z(+20°C) ≤ 1.15 Z(-55°C)/Z(+20°C) ≤ 1.25 (at 100kHz)										
Endurance	The following specifications shall be satisfied when the capacitors are restored to 20°C after the rated voltage is applied for 15,000 hours at 105°C.										
	<table border="1" style="width: 100%; border-collapse: collapse;"> <tr><td>Appearance</td><td>No significant damage</td></tr> <tr><td>Capacitance change</td><td>≤ ±20% of the initial value</td></tr> <tr><td>D.F. (tan δ)</td><td>≤ 150% of the initial specified value</td></tr> <tr><td>ESR</td><td>≤ 150% of the initial specified value</td></tr> <tr><td>Leakage current</td><td>≤ The initial specified value</td></tr> </table>	Appearance	No significant damage	Capacitance change	≤ ±20% of the initial value	D.F. (tan δ)	≤ 150% of the initial specified value	ESR	≤ 150% of the initial specified value	Leakage current	≤ The initial specified value
Appearance	No significant damage										
Capacitance change	≤ ±20% of the initial value										
D.F. (tan δ)	≤ 150% of the initial specified value										
ESR	≤ 150% of the initial specified value										
Leakage current	≤ The initial specified value										
Bias Humidity Test	The following specifications shall be satisfied when the capacitors are restored to 20°C after subjecting them to DC voltage at 60°C, 90 to 95% RH for 1,000 hours.										
	<table border="1" style="width: 100%; border-collapse: collapse;"> <tr><td>Appearance</td><td>No significant damage</td></tr> <tr><td>Capacitance change</td><td>≤ ±20% of the initial value</td></tr> <tr><td>D.F. (tan δ)</td><td>≤ 150% of the initial specified value</td></tr> <tr><td>ESR</td><td>≤ 150% of the initial specified value</td></tr> <tr><td>Leakage current</td><td>≤ The initial specified value</td></tr> </table>	Appearance	No significant damage	Capacitance change	≤ ±20% of the initial value	D.F. (tan δ)	≤ 150% of the initial specified value	ESR	≤ 150% of the initial specified value	Leakage current	≤ The initial specified value
Appearance	No significant damage										
Capacitance change	≤ ±20% of the initial value										
D.F. (tan δ)	≤ 150% of the initial specified value										
ESR	≤ 150% of the initial specified value										
Leakage current	≤ The initial specified value										
Surge Voltage Test	The capacitors shall be subjected to 1,000 cycles each consisting of charge with the surge voltage specified at 105°C for 30 seconds through a protective resistor (R=1kΩ) and discharge for 5 minutes 30 seconds.										
	<table border="1" style="width: 100%; border-collapse: collapse;"> <tr><td>Appearance</td><td>No significant damage</td></tr> <tr><td>Capacitance change</td><td>≤ ±20% of the initial value</td></tr> <tr><td>D.F. (tan δ)</td><td>≤ 150% of the initial specified value</td></tr> <tr><td>ESR</td><td>≤ 150% of the initial specified value</td></tr> <tr><td>Leakage current</td><td>≤ The initial specified value</td></tr> </table>	Appearance	No significant damage	Capacitance change	≤ ±20% of the initial value	D.F. (tan δ)	≤ 150% of the initial specified value	ESR	≤ 150% of the initial specified value	Leakage current	≤ The initial specified value
Appearance	No significant damage										
Capacitance change	≤ ±20% of the initial value										
D.F. (tan δ)	≤ 150% of the initial specified value										
ESR	≤ 150% of the initial specified value										
Leakage current	≤ The initial specified value										
Failure Rate	0.5% per 1,000 hours maximum (Confidence level 60% at 105°C)										

*Note : If any doubt arises, measure the leakage current after the following voltage treatment.
Voltage treatment : DC rated voltage is applied to the capacitors for 120 minutes at 105°C.

◆ DIMENSIONS [mm]

● Terminal Code : E

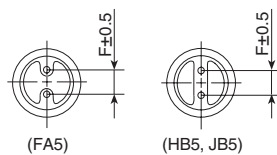
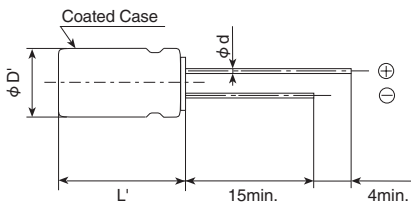

Size code	FA5	HB5	JB5
φ D	6.3	8.0	10.0
φ d	0.5	0.8	
F	2.5	3.5	5.0
φ D'	φ D+0.5max		
L'	L+0.3max	L+1.5max	

◆ MARKING

EX) 4V560μF





NPCAP™-PSA Series

◆PART NUMBERING SYSTEM

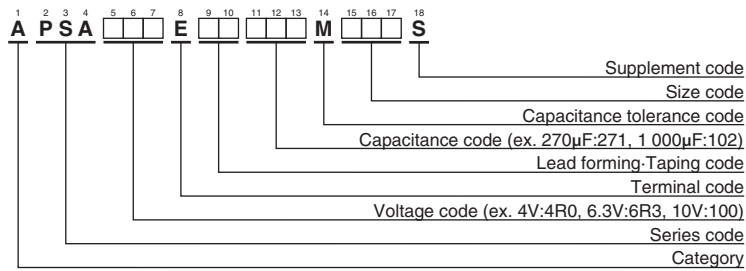

Please refer to "Product code guide (conductive polymer type)"

◆STANDARD RATINGS

WV (V _{dc})	Cap (μF)	Case size φ D × L (mm)	ESR (mΩ max./20°C, 100k to 300kHz)	Rated ripple current (mA rms/105°C, 100kHz)	Part No.
2.5	390	6.3 × 10.5	20	3,160	APSA2R5E□□□391MFA5S
	680	8 × 11.5	7	5,580	APSA2R5E□□□681MHB5S
	820	8 × 11.5	7	5,580	APSA2R5E□□□821MHB5S
	1,000	10 × 11.5	6	5,860	APSA2R5E□□□102MJB5S
	1,500	10 × 11.5	7	5,860	APSA2R5E□□□152MJB5S
4	270	6.3 × 10.5	20	3,160	APSA4R0E□□□271MFA5S
	390	6.3 × 10.5	24	3,300	APSA4R0E□□□391MFA5S
	560	8 × 11.5	7	5,580	APSA4R0E□□□561MHB5S
	820	10 × 11.5	6	5,860	APSA4R0E□□□821MJB5S
6.3	220	6.3 × 10.5	20	3,160	APSA6R3E□□□221MFA5S
	330	6.3 × 10.5	28	3,190	APSA6R3E□□□331MFA5S
	390	8 × 11.5	8	5,080	APSA6R3E□□□391MHB5S
	470	8 × 11.5	7	5,700	APSA6R3E□□□471MHB5S
	680	10 × 11.5	7	5,860	APSA6R3E□□□681MJB5S
10	47	6.3 × 10.5	25	2,820	APSA100E□□□470MFA5S
	68	6.3 × 10.5	25	2,820	APSA100E□□□680MFA5S
	100	6.3 × 10.5	25	2,820	APSA100E□□□101MFA5S
	150	6.3 × 10.5	25	2,820	APSA100E□□□151MFA5S
	270	8 × 11.5	9	4,710	APSA100E□□□271MHB5S
16	470	10 × 11.5	8	5,650	APSA100E□□□471MJB5S
	100	6.3 × 10.5	25	2,820	APSA160E□□□101MFA5S

□□ : Enter the appropriate lead forming or taping code.



NPCAP™-PS Series

- Super low ESR, high temperature resistance
- Large capacitance & Improved high ripple current capability
- Rated voltage range : 2.5 to 35V_{dc}
- Endurance : 15,000 hours at 105°C
- Suitable for DC-DC converters, voltage regulators and decoupling applications
For computer motherboards
- Solvent resistant type (see PRECAUTIONS AND GUIDELINES)
- RoHS Compliant
- Halogen Free

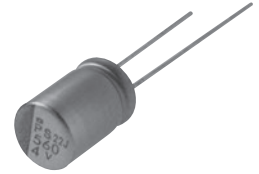
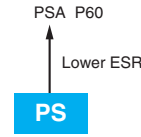

◆ SPECIFICATIONS

Items	Characteristics										
Category	-55 to +105°C										
Temperature Range	-55 to +105°C										
Rated Voltage Range	2.5 to 35V _{dc}										
Capacitance Tolerance	±20% (M) (at 20°C, 120Hz)										
Surge Voltage	Rated voltage × 1.15 (at 105°C)										
Leakage Current <small>*Note</small>	I=0.2CV (Rated voltage 2.5 to 25V _{dc}) / I=0.5CV (Rated voltage 35V _{dc}) Where, I : Max. leakage current (μA), C : Nominal capacitance (μF), V : Rated voltage (V _{dc}) (at 20°C after 2 minutes)										
Dissipation Factor (tan δ)	0.12 max. (at 20°C, 120Hz)										
Low Temperature Characteristics (Max. Impedance Ratio)	Z(-25°C)/Z(+20°C) ≤ 1.15 Z(-55°C)/Z(+20°C) ≤ 1.25 (at 100kHz)										
Endurance	The following specifications shall be satisfied when the capacitors are restored to 20°C after the rated voltage is applied for 15,000 hours at 105°C. <table border="1" style="width: 100%; border-collapse: collapse;"> <tr><td>Appearance</td><td>No significant damage</td></tr> <tr><td>Capacitance change</td><td>≤ ±20% of the initial value</td></tr> <tr><td>D.F. (tan δ)</td><td>≤ 150% of the initial specified value</td></tr> <tr><td>ESR</td><td>≤ 150% of the initial specified value</td></tr> <tr><td>Leakage current</td><td>≤ The initial specified value</td></tr> </table>	Appearance	No significant damage	Capacitance change	≤ ±20% of the initial value	D.F. (tan δ)	≤ 150% of the initial specified value	ESR	≤ 150% of the initial specified value	Leakage current	≤ The initial specified value
Appearance	No significant damage										
Capacitance change	≤ ±20% of the initial value										
D.F. (tan δ)	≤ 150% of the initial specified value										
ESR	≤ 150% of the initial specified value										
Leakage current	≤ The initial specified value										
Bias Humidity Test	The following specifications shall be satisfied when the capacitors are restored to 20°C after subjecting them to DC voltage at 60°C, 90 to 95% RH for 1,000 hours. <table border="1" style="width: 100%; border-collapse: collapse;"> <tr><td>Appearance</td><td>No significant damage</td></tr> <tr><td>Capacitance change</td><td>≤ ±20% of the initial value</td></tr> <tr><td>D.F. (tan δ)</td><td>≤ 150% of the initial specified value</td></tr> <tr><td>ESR</td><td>≤ 150% of the initial specified value</td></tr> <tr><td>Leakage current</td><td>≤ The initial specified value</td></tr> </table>	Appearance	No significant damage	Capacitance change	≤ ±20% of the initial value	D.F. (tan δ)	≤ 150% of the initial specified value	ESR	≤ 150% of the initial specified value	Leakage current	≤ The initial specified value
Appearance	No significant damage										
Capacitance change	≤ ±20% of the initial value										
D.F. (tan δ)	≤ 150% of the initial specified value										
ESR	≤ 150% of the initial specified value										
Leakage current	≤ The initial specified value										
Surge Voltage Test	The capacitors shall be subjected to 1,000 cycles each consisting of charge with the surge voltage specified at 105°C for 30 seconds through a protective resistor (R=1kΩ) and discharge for 5 minutes 30 seconds. <table border="1" style="width: 100%; border-collapse: collapse;"> <tr><td>Appearance</td><td>No significant damage</td></tr> <tr><td>Capacitance change</td><td>≤ ±20% of the initial value</td></tr> <tr><td>D.F. (tan δ)</td><td>≤ 150% of the initial specified value</td></tr> <tr><td>ESR</td><td>≤ 150% of the initial specified value</td></tr> <tr><td>Leakage current</td><td>≤ The initial specified value</td></tr> </table>	Appearance	No significant damage	Capacitance change	≤ ±20% of the initial value	D.F. (tan δ)	≤ 150% of the initial specified value	ESR	≤ 150% of the initial specified value	Leakage current	≤ The initial specified value
Appearance	No significant damage										
Capacitance change	≤ ±20% of the initial value										
D.F. (tan δ)	≤ 150% of the initial specified value										
ESR	≤ 150% of the initial specified value										
Leakage current	≤ The initial specified value										
Failure Rate	0.5% per 1,000 hours maximum (Confidence level 60% at 105°C)										

*Note : If any doubt arises, measure the leakage current after the following voltage treatment.
Voltage treatment : DC rated voltage is applied to the capacitors for 120 minutes at 105°C.

◆ DIMENSIONS [mm]

● Terminal Code : E

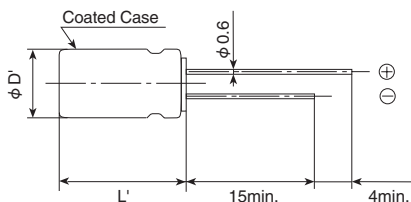

Size code	HB5	JC5
φ D	8	10
φ d	0.6	
F	3.5	5.0
φ D'	φ D+0.5max	
L'	L+1.5max.	

◆ MARKING

EX) 4V820μF





NPCAP™-PS Series

◆PART NUMBERING SYSTEM

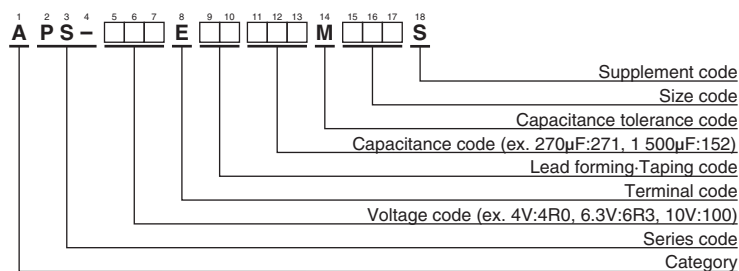

Please refer to "Product code guide (conductive polymer type)"

◆STANDARD RATINGS

WV (V _{dc})	Cap (μF)	Case size φ D×L(mm)	ESR (mΩ max./20°C, 100k to 300kHz)	Rated ripple current (mA rms/105°C, 100kHz)	Part No.
2.5	680	8 × 11.5	10	5,230	APS-2R5E□□681MHB5S
	820	8 × 11.5	10	5,230	APS-2R5E□□821MHB5S
	1,500	10 × 12.5	8	5,500	APS-2R5E□□152MJC5S
4	560	8 × 11.5	10	5,230	APS-4R0E□□561MHB5S
	820	10 × 12.5	8	5,500	APS-4R0E□□821MJC5S
	1,000	10 × 12.5	8	5,500	APS-4R0E□□102MJC5S
	1,200	10 × 12.5	8	5,500	APS-4R0E□□122MJC5S
6.3	390	8 × 11.5	12	4,770	APS-6R3E□□391MHB5S
	470	8 × 11.5	12	4,770	APS-6R3E□□471MHB5S
	680	10 × 12.5	10	5,500	APS-6R3E□□681MJC5S
	820	10 × 12.5	10	5,500	APS-6R3E□□821MJC5S
	1,000	10 × 12.5	10	5,500	APS-6R3E□□102MJC5S
10	270	8 × 11.5	14	4,420	APS-100E□□271MHB5S
	330	8 × 11.5	14	4,420	APS-100E□□331MHB5S
	470	10 × 12.5	12	5,300	APS-100E□□471MJC5S
	560	10 × 12.5	12	5,300	APS-100E□□561MJC5S
16	100	8 × 11.5	16	4,360	APS-160E□□101MHB5S
	180	8 × 11.5	16	4,360	APS-160E□□181MHB5S
	270	10 × 12.5	14	5,050	APS-160E□□271MJC5S
	330	10 × 12.5	14	5,050	APS-160E□□331MJC5S
20	100	8 × 11.5	24	3,320	APS-200E□□101MHB5S
	150	10 × 12.5	20	4,320	APS-200E□□151MJC5S
25	68	8 × 11.5	24	3,320	APS-250E□□680MHB5S
	100	10 × 12.5	20	4,320	APS-250E□□101MJC5S
35	18	8 × 11.5	34	2,830	APS-350E□□180MHB5S
	33	10 × 12.5	30	3,270	APS-350E□□330MJC5S

□□ : Enter the appropriate lead forming or taping code.

Return Group Chart

Conductive Polymer Hybrid Aluminum Electrolytic Capacitors





PRECAUTIONS AND GUIDELINES (Conductive Polymer Hybrid)

Conductive Polymer Hybrid Aluminum Electrolytic Capacitors (Hereinafter called capacitor) that uses highly conductive polymer electrolytic materials and electrolyte. Please read the following in order to get the most out of your capacitor. For Conductive Polymer Aluminum Solid Electrolytic Capacitors, see Precautions and Guidelines (Conductive Polymer). For Aluminum Electrolytic Capacitors, see Precautions and Guidelines (Aluminum Electrolytic Capacitors).

1) Device circuits design considerations

1) Confirm installation and operating requirements for the capacitors, then use them within the performance limits prescribed in this catalog or product specifications.

2) Polarity

Capacitors are polarized.

Never apply a reverse voltage or AC voltage. Connecting with wrong polarity will short-circuit or damage the capacitor with the pressure relief vent opening early on. To identify the polarity of a capacitor, see the relevant diagram in the catalogs or product specifications, or the polarity marking on the body of the capacitors.

3) Operating voltage

Do not apply an over-voltage that exceeds a rated voltage specified for the capacitors.

The total peak value of the ripple voltage plus the DC voltage must not exceed the rated voltage of the capacitors. Capacitors do not require voltage derating within the category temperature. Although capacitors specify a surge voltage that exceeds the full rated voltage, it does not assure long-term use but limited use under specific conditions.

4) Ripple current

Do not apply an over current that exceeds the rated ripple current specified for the capacitors. Excessive ripple current will increase heat production within the capacitors, causing the capacitors to be damaged as follows:

- Shorten lifetime
- Open pressure relief vent
- Short circuit

At the time of low DC bias voltage, reverse voltage may be applied if uses with less than rated ripple current. Please use it as far as the reverse voltage is not applied. The rated ripple current is specified along with a specific ripple frequency. Where using the capacitors at any ripple frequency other than the specified frequency, calculate the allowable ripple current by multiplying the rated ripple current by a frequency compensation factor (Frequency Multiplier) specified for each product series.

5) Operating temperature (Category temperature)

Do not apply high temperatures that exceed the upper limit of the category temperature range specified for the capacitors.

Using the capacitors at temperatures higher than the upper limit will considerably shorten the lifetime of the capacitors and make the pressure relief vent open. The temperature, please confirm the temperature of the capacitors which included the ambient temperature of the device, not only the temperature in the device but also radiant heat of the heating element (power transistor, resistance) in the apparatus, self heating caused by the ripple current. Additionally, please do not place heating element on the back side of the capacitors. In addition, please use the capacitors within category temperature range because the life of the capacitors are affected by the operating temperature. In other words, lowering ambient temperatures will extend the expected lifetime of the capacitors.

6) Lifetime

Select the capacitors to meet the service life requirements of device.

7) Charging and discharging

Do not use capacitors in circuits intended for rapid charge and discharge cycle operations.

If capacitors are used in the circuits that repeat a charge and discharge with a large voltage drop or a rapid charge and discharge at short interval cycle, capacitance will decrease and/or the capacitors will be damaged by internal heat generation.

Please consult us the capacitors to use for the circuit where rapid charge and discharge is repeated.

Please be careful about rush currents. Recommend to install protective circuit.

8) Failure mode of capacitors

Non-solid aluminum electrolytic capacitors have a limited lifetime which ends in an open circuit failure mode, in general.

Depending on the product type and operating conditions, the failure mode may involve in opening of the pressure relief vent.

But it may lead to shot circuit mode failure when capacitor is used in the overload more than the guarantee ranges including over voltage and the over current.

9) Capacitor insulation

The can case of capacitor does not assure electrical insulation.

The outer coating on can case is aimed for indication and does not assure function of the electrical insulation.

Electrically isolate the outer can case of a capacitor from the negative terminal, the positive terminal and circuit patterns.

10) Operating conditions

Do not use/expose capacitors to the following conditions:

- ① Direct contact with water, salt water or oil, or high condensation environment.
- ② Direct sunlight
- ③ Toxic gases such as hydrogen sulfide, sulfurous acid, nitrous acid, chlorine and its compounds, bromine and its compounds and ammonium.
- ④ Ozone, ultraviolet rays or radiation.
- ⑤ Extreme vibration or mechanical shock that exceeds limits in the catalogs or product specifications.

The standard vibration condition is applicable to JIS C 5101-4.

11) Mounting

Capacitors contain paper separators and electric-conductive electrolyte that contains organic solvent as main solvent material, both of which are flammable. If the electrolyte leaks onto a printed circuit board, it can erode the device circuit pattern, may short-circuit the copper traces, smoke and burn. Make sure of designing a PC board as follows:

- ① Provide clearance space (2mm minimum) over the pressure relief vent of a capacitor to avoid blocking the correct opening of the pressure relief vent for 10mm case diameter of capacitor.
- ② Do not locate any wire or circuit pattern over the pressure relief vent of a capacitor.
- ③ Avoid locating any heat source components near capacitors or on the opposite side of the PC board under capacitors.
- ④ Design the solder land on the PC board in accordance with the catalog or the product specification.
- ⑤ For radial capacitors, design the terminal holes on the PC board to fit the terminal dimension of the capacitor.
- ⑥ Do not print any copper trace under the seal (terminal) side of a capacitor. When the electrolyte leaks out, it may occur circuit pattern short-circuit, and tracking or migration. Copper traces should be 1 mm (preferably 2mm or more) spaced apart from the side of the capacitor body.
- ⑦ In designing a double-sided PC board, do not locate any



PRECAUTIONS AND GUIDELINES (Conductive Polymer Hybrid)

- through-hole via or unnecessary hole underneath a capacitor.
- ⑧ In designing a double-sided PC board, do not print any circuit pattern underneath a capacitor.

12) Using capacitors for significantly safety-oriented applications

Consult us about capacitors for a device application affecting human safety (①Aviation and aerospace ②Nuclear ③Medical ④Vehicle) or for any device whose failure will make an impact on society. Note that some products such as photoflash use capacitors which have been designed for specific applications cannot be used for any other application.

13) Others

Design device circuits taking into consideration the following conditions:

- ① Electrical characteristics of a capacitor depend on the temperature and frequency. In designing the device circuits, consider the change in the characteristics.
- ② If using more than one capacitor connected in parallel, design the device circuits to balance the current flow in individual capacitors.
- ③ If using more than one capacitor connected in series, connect shunting resistors in parallel with the individual capacitors to balance the voltage.

2 Installation

1) Assembling

- ① Do not try to reuse the capacitors once assembled and electrified
- ② Capacitors may have been spontaneously recharged with time by a recovery voltage phenomenon.
Capacitors may produce recovery voltage higher than aluminum electrolytic capacitors and conductive polymer aluminum solid capacitors. In this case, discharge electricity through approximately 1kΩ before use.
- ③ If capacitors have been stored at any conditions more than 35°C and 75%RH for long storage periods of time more than the limits specified in the catalogs or product specifications, they may have high leakage current. In this case, make pre-conditioning by applying the rated voltage through a resistor of approximately 1kΩ.
- ④ Confirm the rated capacitance and voltage of capacitors before installation.
- ⑤ Confirm the polarity of capacitors before installation.
- ⑥ Do not try to use the capacitors that were dropped to the floor and so forth.
- ⑦ Do not deform the can case of a capacitor.
- ⑧ Verify that the lead spacing of the capacitor fits the hole spacing in the PC board before installing the capacitors.
- ⑨ Do not apply excessive mechanical force to capacitors more than the limits prescribed in the catalogs or product specifications. Avoid excessive mechanical force while the capacitors are in the process of vacuum-picking, placing and positioning by automatic mounting machines or cutting the lead wires by automatic insertion machines.

2) Soldering and heat resistance

- ① For soldering using a soldering iron, consider the following conditions:
Soldering conditions (temperature and time) should be (380 ± 10°C, 3 ± 0.5second).
Do not touch the body of a capacitor with the hot tip of the soldering iron.
- ② Verify the following when flow soldering:
 - Do not dip the body of a capacitor into the solder bath only dip the terminals in. The soldering must be done on the reverse side of PC board.
 - Soldering conditions (preheat, solder temperature and dipping time) should be within the limits prescribed in the catalog or the product specifications.
 - Do not apply flux to any part of capacitors other than their terminals.
 - Make sure the capacitors do not come into contact with any other components while soldering.

- ③ For reflow soldering, consider the following conditions:
Soldering conditions (preheat, reflow temperature and time) should be within the limits prescribed in the catalogs or product specifications.
 - When using the infrared heater and setting its temperatures, adjust the heating levels taking into consideration that the color and materials of a capacitor vary in their infrared absorbance.
 - The allowable number of reflow passes is specified in the catalogs or product specifications.
 - Please consult us about vapor phase soldering (VPS).
- ④ Do not try to reuse the capacitors once assembled.
- ⑤ Only use radial lead type capacitors for flow soldering. The other type capacitors are not designed for the flow soldering.
- ⑥ Only use chip type capacitors for reflow soldering. The other type capacitors are not designed for the reflow soldering.

3) Handling after soldering

After soldering the PC board, do not apply the following mechanical stress to the capacitor:

- ① Do not tilt, push down or twist the body of the capacitor.
- ② Do not grab the body of the capacitor to carry the assembly board.
- ③ Do not hit anything against the capacitor. When stacking the assembled boards, do not put any of the PC boards or other components against the capacitor.
- ④ Do not drop the assembled board.

4) Cleaning assembly boards

- ① Do not clean capacitors with the following cleaning agents:
 - Halogenated solvents: cause capacitor failures due to corrosion.
 - Alkali system solvents: corrode (dissolve) the aluminum can case.
 - Terpene and petroleum system solvents: deteriorate the rubber seal materials.
 - Xylene: deteriorates the rubber seal materials as well.
 - Acetone: erases the markings printed on a capacitor.

Where cleaning is necessary, use only solvent resistant type capacitors that have been assured for the cleaning within the specific cleaning conditions prescriber in the catalogs or product specifications. In particular, carefully set up the conditions for ultrasonic cleaning system. Consult us regarding alternative CFCs or other cleaners before use.

- ② Where cleaning the capacitors, confirm the following conditions:
 - Control the contamination (the conductivity, pH, specific gravity, water content, etc.) of the cleaning agents.
 - After the cleaning, do not leave the capacitors (assembly boards) in an environment of cleaning agent-rich or in a closed container. Sufficiently evaporate the residual cleaning agent from the assembly boards and the capacitors by forced hot air at temperatures less than the upper limit of category temperature range for more than 10 minutes.

In general, aluminum electrolytic capacitors are sensitive to contamination of halogen ions (particularly to chlorine ions). Depending on the properties of the electrolyte and rubber seal materials used in a capacitor, the halogen ions lead up to catastrophic failures on the capacitor. Where the inside of a capacitor has been contaminated with more than a certain amount of halogen ions and the capacitor is in use, the corrosion reaction of aluminum occurs. The corrosion causes the capacitor to have a significant increase in leakage current with heat produced, open the pressure relief vent and become open circuit mode failure. Due to global environmental issues (greenhouse effects and other environmental destruction by depletion of the ozone layer), the conventional cleaning solvents of CFC 113, Trichloroethylene and 1,1,1-trichloroethylene were replaced by substitutes. The following are some substitute cleaning agents and allowable cleaning conditions:

- a) Fatty-alcohol cleaning agents
Pine Alpha ST-100S (Arakawa Chemical)
Clean Through 750H, 750K, 750L and 710M (Kao)
Technocare FRW-14, 15, 16 and 17 (Momentive Performance Materials)
- [Cleaning conditions]
Either of immersion or ultrasonic cleaning, for a maximum of 10 minutes and at a maximum liquid temperature of 60



PRECAUTIONS AND GUIDELINES (Conductive Polymer Hybrid)

°C is acceptable. Make sure that the markings on the capacitor are not rubbed against any other component or the PC board during cleaning. Note that shower cleaning affects the markings on the capacitor.

b) Alternative CFCs

AK225AES (Asahi Glass)

[Cleaning conditions]

Solvent resistant type capacitors, which were originally developed to intend to resist Freon TE or Freon TES, are also capable of withstanding any one of immersion, ultrasonic or vapor cleaning, for a maximum of 5 minutes.

However, this type of cleaning agent is not recommended to use, as the cleaning materials may be banned in near future in view of global environmental issues

c) IPA (Isopropyl Alcohol)

Immersion cleaning with a maximum flux concentration of 2 wt% is acceptable.

5) Adhesives and coating materials

- ① Do not use any adhesive or coating materials containing halogenated solvents.
- ② Make sure of the following conditions before applying adhesive or coating materials to a capacitor,
 - No flux residue nor stain is left between the rubber seal of a capacitor and PC board.
 - Dry the capacitor to remove residual cleaning agents before applying adhesive and coating materials. Do not cover up the entire surface of the rubber seal of the capacitor with adhesives or coating materials.
 - Consult us Heating and curing conditions for adhesives and coating materials.
 - Covering up the entire surface of the rubber seal with resin mold materials will obstruct the normal diffusion of internal hydrogen gas from a capacitor and result in serious failures. Also, where the adhesive and coating materials contain a large amount of halogen ions, the halogen ions will contaminate the inside of the capacitor through the rubber seal materials, causing the capacitor to become a failure.
 - Depending on solvent materials that the adhesive or coating materials contains, note that the surface of a capacitor may change in appearance.

6) Fumigation

In exporting or importing electronic devices, they may be exposed to fumigation with halide such as methyl bromide.

Where the capacitors are exposed to halide such as methyl bromide, the capacitors will be damaged with the corrosion reaction with halogen ions in the same way as cleaning agents. For the export and import, Nippon Chemi-Con considers using some packaging method and so forth so that fumigation is not required. For customers to export or import electronic devices, semi-assembly products or capacitor components, confirm if they will be exposed to fumigation and also consider final condition of packaging. (Note that either cardboard or vinyl package has a risk of fumigation gas penetration.)

3) Precautions during operation of devices

- (1) Never touch the terminals of a capacitor directly with bare hands.
- (2) Do not short-circuit between the capacitor terminals with anything conductive. Also, do not spill any conductive liquid such as acid or alkaline solution over a capacitor.
- (3) Confirm environmental conditions where the device will be placed. Do not use the device in the following environmental conditions:
 - ① Water or oil spatters, or high condensation environment.
 - ② Direct sunlight.

- ③ Ozone, ultraviolet rays or radiation.
- ④ Toxic gases such as hydrogen sulfide, sulfuric acid, nitrous acid, chlorine and its compounds, bromine and its compounds and ammonium.
- ⑤ Severe vibration or mechanical shock conditions beyond the limits prescribed in the catalog or product specification. The standard vibration condition is applicable to JIS C 5101-4.

4) Maintenance inspections

- (1) For industrial use capacitors, make periodic inspections of the capacitors. Before the inspections, turn off the power supply of the device and discharge the electricity of the capacitors. Where checking it by a volt-ohm meter, confirm the polarity beforehand. Do not apply mechanical stress to the terminals of the capacitors during inspection.
- (2) Characteristics to be inspected
 - ① Significant damage in appearance: vent opening, electrolyte leakage, etc.
 - ② Electrical characteristics: leakage current, capacitance, $\tan \delta$ and other characteristics prescribed in the catalogs or product specifications. If finding anything abnormal on the characteristics above, check the specifications of the capacitor and take appropriate actions such as replacement.

5) Contingencies

- 1) A capacitor with more than a certain case size has the pressure relief vent functioning to escape abnormal gas pressure increase. If gas expels from a venting capacitor, disconnect the power supply of the device or unplug the power supply cord. If not disconnecting the power supply, the device circuit may be damaged due to the short circuit failure of the capacitor or short-circuited with the liquid that the gas was condensed to. It may cause secondary damages such as device burnout in the worst case scenario. The gas that comes out of the open vent is vaporized electrolyte not smoke.
- 2) The gas expelled from a venting capacitor is more than 100°C. Never expose your face to the capacitor. If your eyes are exposed to the gas or you inhale it, immediately flush your eyes and/or gargle with water. If the electrolyte comes in contact with the skin, wash with soap and water.

6) Storage

- 1) Do not store capacitors at high temperature or high humidity. Store the capacitors indoors at temperatures of 5 to 35°C and humidities of less than 75%RH. In principle, aluminum electrolytic capacitors should be used within 2 years after production.
- 2) Keep capacitors packed in the original packaging material whenever possible.
- 3) Avoid the following storage environmental conditions:
 - ① Water spattering, high temperatures, high humidity or condensation environment.
 - ② Oil spattering or oil mist filled.
 - ③ Salt water spattering or salt filled.
 - ④ Acidic toxic gases such as hydrogen sulfide, sulfuric acid, nitrous acid, chlorine, bromine and methyl bromide filled.
 - ⑤ Alkaline toxic gases such as ammonium filled.
 - ⑥ Acid or alkaline solutions spattering.
 - ⑦ Direct sunlight, ozone, ultraviolet rays or radiation.
 - ⑧ Extreme vibration or shock loading.
- 4) JEDEC J-STD-020 is not applicable.

7) Capacitor disposal

Please consult with a local organization for the proper disposal of industrial waste. For incinerating capacitors, apply a high temperature incineration (over 800°C). Incinerating them at temperatures lower than that may produce toxic gases such as



chlorine. To prevent capacitors from explosion, punch holes in or sufficiently crush the can cases of the capacitors, then incinerate.

8 About AEC-Q200

The Automotive Electronics Council (AEC) was originally established by major American automotive related manufactures. Today, the committees are composed of representatives from the sustaining Members of manufacturing companies in automotive electrical components. It has standardized the criteria for “stress test qualification” and “reliability tests” for electronic components.

AEC-Q200 is the reliability test standard for approval of passive components in Automotive applications. It specifies the test type, parameters and quantity, etc. for each component. The criteria of the reliability tests such as for our main products, “Aluminum Electrolytic Capacitors” are described in this standard.

Pursuant to the customer’s specific testing requirements, Chemi-Con submits the test results according to AEC-Q200 for Aluminum Electrolytic Capacitors used in automotive applications on request.

An electronic component manufacturer cannot simply claim that their product is “AEC-Q200 Qualified”. It can be claimed “Compliant”, “Capable”, “Available”, etc., however each component must be tested per each users “Qualification Test Plan” in order to claim AEC-Q200 status.

Please contact us for more information.

9 Regarding compliance for EU REACH Regulation

- 1) According to the content of REACH handbook (Guidance on requirements for substances in articles which is published on May 2008), our electronic components are “articles without any intended release” . Therefore they are not applicable for “Registration” for EU REACH Regulation Article 7 (1). Reference: Electrolytic Condenser Investigation Society “Study of REACH Regulation in EU about Electrolytic Capacitor” (publicized on 13 March 2008)
- 2) Nippon Chemi-Con develops the products without substance of very high concern (SVHC).

10 Catalogs

Specifications in the catalogs are subject to change without notice. Test data shown in the catalogs are not assured as the whole performance values, but typical values. For more details, refer to JEITA RCR-2367C (March 2006) with the title of “Safety Application Guide for fixed aluminum electrolytic capacitors for use in electronic equipment”.



RECOMMENDED SOLDERING CONDITIONS

◆ SURFACE MOUNT TYPE

The following conditions are recommended for air or infrared reflow soldering HXC/HXD/HXA/HXB series onto a glass epoxy circuit board of 90×50×0.8mm (with resist) by cream solder. The temperatures shown are the surface temperature values on the top of the can and temperature of capacitor terminal.

Reflow should be performed twice or less.

Please ensure that the capacitor became cold enough to the room temperature (5 to 35°C) before the second reflow.

● Recommended soldering heat conditions

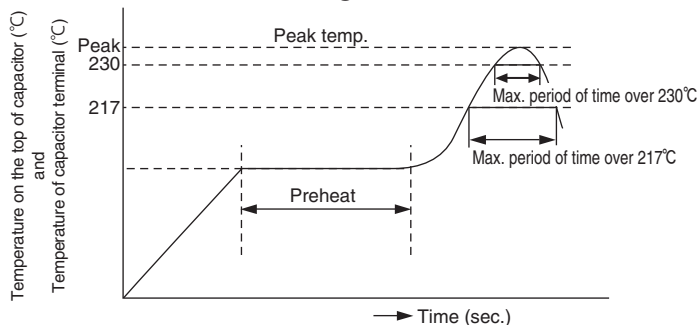

Size Code	Preheat	Time maintained above 217°C	Time maintained above 230°C	Peak temp.	Reflow number
E61, F61, F80	150 to 180V	50 sec. max.	40 sec. max.	260°C max.	2-cycle allowed
HA0, JA0	120 sec. max.	50 sec. max.	40 sec. max.	260°C max. 245°C max.	1-cycle only 2-cycle allowed

● Recommended Solder Land on PC Board

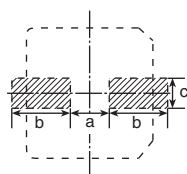

Solder land on PC board

Size code	[mm]		
	a	b	c
E61	1.4	3.0	1.6
F61, F80	1.9	3.5	1.6
HA0	3.1	4.2	2.2
JA0	4.5	4.4	2.2

◆ RADIAL LEAD TYPE

● Recommended soldering heat conditions

Preheat : 150°C 120 seconds max.

Flow soldering : 260±5°C max. 10+1 seconds max.

◆ PRECAUTIONS FOR USERS

Soldering method

SMD type have no capability to withstand such dip or wave soldering as totally immersing components into a solder bath.

Reflow soldering

Reflow the capacitors within Recommended Reflow Soldering Conditions. Verify there is no temperature stress to the capacitors because the following differences might degrade capacitors electrically and mechanically. Please consult with us if other reflow conditions are employed.

1. Location of components : Temperature increases at the edge of PC board more than the center.
2. Population of PC board : The lower the component population is, the more temperature rises.
3. Material of PC board : A ceramic-made board needs more heat than a glass epoxy-made board. The heat increase may cause damage to the capacitors.
4. Thickness of PC board : A thicker board needs more heat than a thinner board. The heat may damage the capacitors.
5. Size of PC board : A larger board needs more heat than a smaller board. The heat may damage the capacitors.
6. Solder thickness
If very thin cream solder paste is to be used for SMD types, please consult with us.
7. Location of infrared ray lamps : IR reflow as well as hot plate reflow heats only on the reverse side of the PC board to lessen heat stress to the capacitors.
8. Case leakage current will increase (~mA) after the reflow process, the leakage current which rose gradually decreases when voltage is applied.
9. Please consult us about vapor phase soldering (VPS).

Rework of soldering

Use a soldering iron for rework. Do not exceed an iron tip temperature of 380±10°C and an exposure time of 3±0.5 seconds.

Mechanical stress

Do not grab the capacitors to lift the PC board and give stress to the capacitor. Avoid bending the PC board. This may damage the capacitors.

Cleaning assembly board

Immediately after solvent cleaning, remove residual solvent with an air knife for at least 10 minutes. If the solvent is insufficiently dry, the capacitors may corrode.

Coating on assembly board

1. Before curing coating material, remove the cleaning solvents from the assembly board.
2. Before conformal coating, a chloride free pre-coat material is recommended to decrease the stress on the capacitors.

Molding with resin

Internal chemical reaction gradually produces gas in the capacitor; increasing internal pressure. If the end seal of the capacitor is completely covered by resin the gas will be unable to escape causing a potentially dangerous situation. The chlorine in resin will penetrate the end seal, reach the element, and damage of the capacitor.

Glue

The followings are requirements for glue.

1. A low curing temperature over a short period of time
2. Strong adhesion and heat resistance after curing
3. Long shelf life
4. No corrosion

Others

Refer to PRECAUTIONS AND GUIDELINES(Conductive Polymer Hybrid).



PART NUMBERING SYSTEM

Product code guide (Conductive polymer hybrid Surface mount type)

(Example : HXA series, 16V-82μF, φ6.3×5.8L)



Please refer to the following table

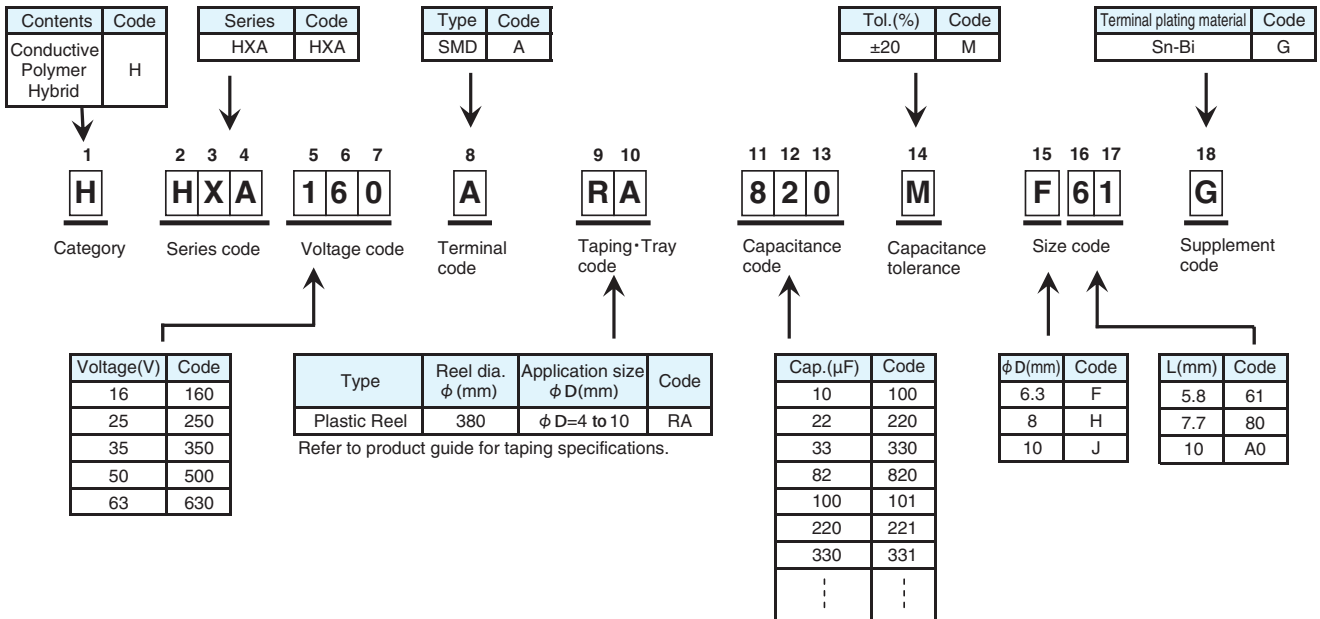

Product code guide (Conductive polymer hybrid Radial lead type)

(Example : HSC series, 25V-330μF, φ10×12.5L, Long Lead with bulk)



Please refer to the following table

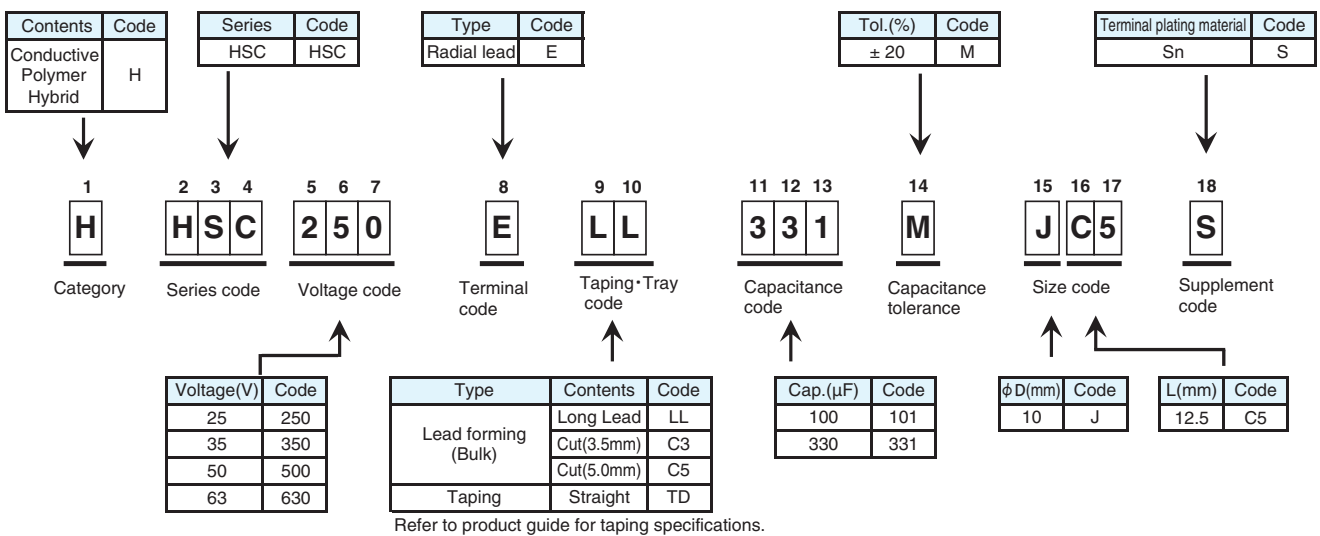

Return Group Chart



CONDUCTIVE POLYMER HYBRID ALUMINUM ELECTROLYTIC CAPACITORS

Surface Mount

HXC Series New!

- High reliability and high voltage are realized by hybrid electrolyte
- Endurance with ripple current : 4,000 hours at 125°C
- Rated voltage range : 16 to 63V_{dc}, Capacitance range : 6.8 to 470μF
- For high temperature and high reliability applications.
(Automotive equipment, Base station equipment, etc.)
- RoHS Compliant
- Halogen Free
- AEC-Q200 compliant : Please contact Chemi-Con for more details, test data, information.

HXC

Higher temperature
HXD P74



SPECIFICATIONS

Items	Characteristics						
Category	-55 to +125°C						
Temperature Range	-55 to +125°C						
Rated Voltage Range	16 to 63V _{dc}						
Capacitance Tolerance	±20% (M) (at 20°C, 120Hz)						
Leakage Current	I=0.01CV Where, I : Max. leakage current (μA), C: Nominal capacitance(μF), V : Rated voltage(V) (at 20°C after 2 minutes)						
Dissipation Factor (tan δ)	Rated voltage(V _{dc})	16V	25V	35V	50V	63V	
	tan δ (Max.)	0.16	0.14	0.12	0.10	0.08	(at 20°C, 120Hz)
Low Temperature Characteristics (Max. Impedance Ratio)	Z(-25°C)/Z(+20°C) ≤ 1.5 Z(-55°C)/Z(+20°C) ≤ 2.0 (at 100kHz)						
Endurance	The following specifications shall be satisfied when the capacitors are restored to 20°C after subjected to DC voltage with the rated ripple current is applied (the peak voltage shall not exceed the rated voltage) for 4,000 hours at 125°C.						
	Capacitance change	≤ ±30% of the initial value					
	D.F. (tan δ)	≤ 200% of the initial specified value					
	ESR	≤ 200% of the initial specified value					
	Leakage current	≤ The initial specified value					
Shelf Life	The following specifications shall be satisfied when the capacitors are restored to 20°C after exposing them for 1,000 hours at 125°C without voltage applied. Before the measurement, the capacitor shall be preconditioned by applying voltage according to item 4.1 of JIS C 5101-4.						
	Capacitance change	≤ ±30% of the initial value					
	D.F. (tan δ)	≤ 200% of the initial specified value					
	ESR	≤ 200% of the initial specified value					
	Leakage current	≤ The initial specified value					
Bias Humidity Test	The following specifications shall be satisfied when the capacitors are restored to 20°C after subjecting them to the DC rated voltage at 85°C, 85% RH for 2,000 hours.						
	Appearance	No significant damage					
	Capacitance change	≤ ±30% of the initial value					
	D.F. (tan δ)	≤ 200% of the initial specified value					
	ESR	≤ 200% of the initial specified value					
	Leakage current	≤ The initial specified value					

DIMENSIONS [mm]

Terminal Code : A

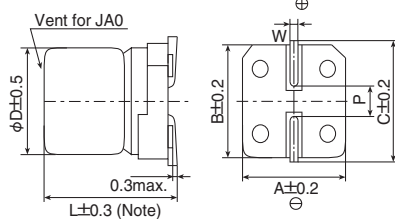

Note : L±0.5 for HA0 and JA0

Size Code	φD	L	A	B	C	W	P
E61	5	5.8	5.3	5.3	5.9	0.5 to 0.8	1.4
F61	6.3	5.8	6.6	6.6	7.2	0.5 to 0.8	1.9
F80	6.3	7.7	6.6	6.6	7.2	0.5 to 0.8	1.9
HA0	8	10.0	8.3	8.3	9.0	0.7 to 1.1	3.1
JA0	10	10.0	10.3	10.3	11.0	0.7 to 1.1	4.5

MARKING

EX) 35V270μF



Rated voltage symbol

Rated voltage (V _{dc})	Symbol
16	C
25	E
35	V
50	H
63	J

PART NUMBERING SYSTEM

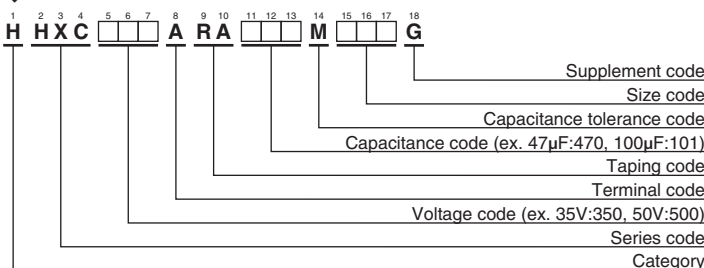

Please refer to "Product code guide (conductive polymer hybrid type)"

Return Group Chart



CONDUCTIVE POLYMER HYBRID ALUMINUM ELECTROLYTIC CAPACITORS

Surface Mount



◆ STANDARD RATINGS

WV (V _{dc})	Cap (μF)	Size code	ESR (mΩ max./20°C, 100kHz)	Rated ripple current (mA _{rms} /125°C, 100kHz)	Part No.
16	47	E61	80	550	HHXC160ARA470ME61G
	82	F61	45	950	HHXC160ARA820MF61G
	150	F80	27	1,450	HHXC160ARA151MF80G
	270	HA0	22	1,700	HHXC160ARA271MHA0G
	470	JA0	18	2,100	HHXC160ARA471MJA0G
25	33	E61	80	550	HHXC250ARA330ME61G
	47	F61	50	900	HHXC250ARA470MF61G
	56	F61	50	900	HHXC250ARA560MF61G
	68	F80	30	1,400	HHXC250ARA680MF80G
	100	F80	30	1,400	HHXC250ARA101MF80G
	150	HA0	27	1,600	HHXC250ARA151MHA0G
	220	HA0	27	1,600	HHXC250ARA221MHA0G
	270	JA0	20	2,000	HHXC250ARA271MJA0G
35	330	JA0	20	2,000	HHXC250ARA331MJA0G
	22	E61	100	550	HHXC350ARA220ME61G
	27	F61	60	900	HHXC350ARA270MF61G
	47	F61	60	900	HHXC350ARA470MF61G
	47	F80	35	1,400	HHXC350ARA470MF80G
	68	F80	35	1,400	HHXC350ARA680MF80G
	100	HA0	27	1,600	HHXC350ARA101MHA0G
	150	HA0	27	1,600	HHXC350ARA151MHA0G
50	150	JA0	20	2,000	HHXC350ARA151MJA0G
	270	JA0	20	2,000	HHXC350ARA271MJA0G
	10	E61	120	500	HHXC500ARA100ME61G
	10	F61	80	750	HHXC500ARA100MF61G
	15	F80	40	1,100	HHXC500ARA150MF80G
	22	F61	80	750	HHXC500ARA220MF61G
	33	F80	40	1,100	HHXC500ARA330MF80G
	33	HA0	30	1,250	HHXC500ARA330MHA0G
	47	HA0	30	1,250	HHXC500ARA470MHA0G
63	56	JA0	25	1,600	HHXC500ARA560MJA0G
	68	HA0	30	1,250	HHXC500ARA680MHA0G
	100	JA0	25	1,600	HHXC500ARA101MJA0G
	120	JA0	25	1,600	HHXC500ARA121MJA0G
	6.8	F61	120	700	HHXC630ARA6R8MF61G
	10	F61	120	700	HHXC630ARA100MF61G
	10	F80	80	900	HHXC630ARA100MF80G
	22	F80	80	900	HHXC630ARA220MF80G
	22	HA0	40	1,100	HHXC630ARA220MHA0G
63	33	HA0	40	1,100	HHXC630ARA330MHA0G
	33	JA0	30	1,400	HHXC630ARA330MJA0G
	47	HA0	40	1,100	HHXC630ARA470MHA0G
	56	JA0	30	1,400	HHXC630ARA560MJA0G
	82	JA0	30	1,400	HHXC630ARA820MJA0G

Product specifications in this catalog are subject to change without notice. Request our product specifications before purchase and/or use. Please use our products based on the information contained in this catalog and product specifications.

Return Group Chart



CONDUCTIVE POLYMER HYBRID ALUMINUM ELECTROLYTIC CAPACITORS

Surface Mount

HXD Series New!

- High reliability and high voltage are realized by hybrid electrolyte
- Endurance with ripple current : 5,000 hours at 105°C
- Rated voltage range : 16 to 63V_{dc}, Capacitance range : 6.8 to 470μF
- For high reliability applications.
(Automotive equipment, Base station equipment, etc.)
- RoHS Compliant
- Halogen Free
- AEC-Q200 compliant : Please contact Chemi-Con for more details, test data, information.

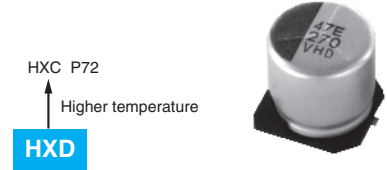

◆ SPECIFICATIONS

Items	Characteristics						
Category Temperature Range	-55 to +105°C						
Rated Voltage Range	16 to 63V _{dc}						
Capacitance Tolerance	±20% (M) (at 20°C, 120Hz)						
Leakage Current	I=0.01CV Where, I : Max. leakage current (μA), C: Nominal capacitance(μF), V : Rated voltage(V) (at 20°C after 2 minutes)						
Dissipation Factor (tan δ)	Rated voltage(V _{dc})	16V	25V	35V	50V	63V	
	tan δ (Max.)	0.16	0.14	0.12	0.10	0.08	(at 20°C, 120Hz)
Low Temperature Characteristics (Max. Impedance Ratio)	Z(-25°C)/Z(+20°C) ≤ 1.5 Z(-55°C)/Z(+20°C) ≤ 2.0 (at 100kHz)						
Endurance	The following specifications shall be satisfied when the capacitors are restored to 20°C after subjected to DC voltage with the rated ripple current is applied (the peak voltage shall not exceed the rated voltage) for 5,000 hours at 105 °C.						
	Capacitance change	≤ ±30% of the initial value					
	D.F. (tan δ)	≤ 200% of the initial specified value					
	ESR	≤ 200% of the initial specified value					
	Leakage current	≤ The initial specified value					
Shelf Life	The following specifications shall be satisfied when the capacitors are restored to 20°C after exposing them for 1,000 hours at 105 °C without voltage applied. Before the measurement, the capacitor shall be preconditioned by applying voltage according to item 4.1 of JIS C 5101-4.						
	Capacitance change	≤ ±30% of the initial value					
	D.F. (tan δ)	≤ 200% of the initial specified value					
	ESR	≤ 200% of the initial specified value					
	Leakage current	≤ The initial specified value					
Bias Humidity Test	The following specifications shall be satisfied when the capacitors are restored to 20°C after subjecting them to the DC rated voltage at 85°C, 85% RH for 2,000 hours.						
	Appearance	No significant damage					
	Capacitance change	≤ ±30% of the initial value					
	D.F. (tan δ)	≤ 200% of the initial specified value					
	ESR	≤ 200% of the initial specified value					
	Leakage current	≤ The initial specified value					

◆ DIMENSIONS [mm]

● Terminal Code : A

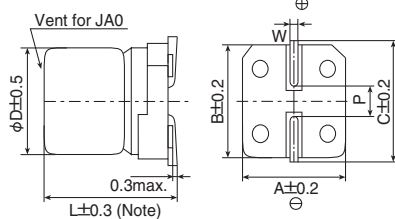

Note : L±0.5 for HA0 and JA0

Size Code	φD	L	A	B	C	W	P
E61	5	5.8	5.3	5.3	5.9	0.5 to 0.8	1.4
F61	6.3	5.8	6.6	6.6	7.2	0.5 to 0.8	1.9
F80	6.3	7.7	6.6	6.6	7.2	0.5 to 0.8	1.9
HA0	8	10.0	8.3	8.3	9.0	0.7 to 1.1	3.1
JA0	10	10.0	10.3	10.3	11.0	0.7 to 1.1	4.5

◆ MARKING

EX) 35V47μF



● Rated voltage symbol

Rated voltage (V _{dc})	Symbol
16	C
25	E
35	V
50	H
63	J

◆ PART NUMBERING SYSTEM

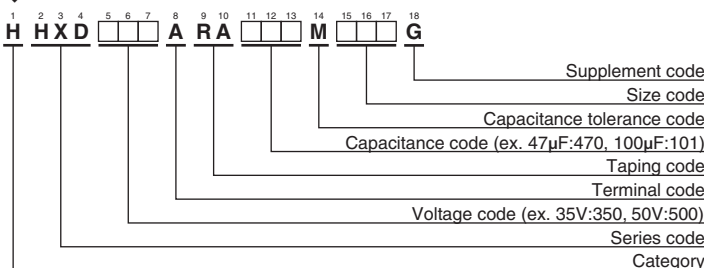

Please refer to "Product code guide (conductive polymer hybrid type)"

Return Group Chart



CONDUCTIVE POLYMER HYBRID ALUMINUM ELECTROLYTIC CAPACITORS

Surface Mount



◆ STANDARD RATINGS

WV (V _{dc})	Cap (μF)	Size code	ESR (mΩ max./20°C, 100kHz)	Rated ripple current (mA _{rms} /105°C, 100kHz)	Part No.
16	47	E61	80	900	HHXD160ARA470ME61G
	82	F61	45	1,600	HHXD160ARA820MF61G
	150	F80	27	2,200	HHXD160ARA151MF80G
	270	HA0	22	2,500	HHXD160ARA271MHA0G
	470	JA0	18	2,600	HHXD160ARA471MJA0G
25	33	E61	80	900	HHXD250ARA330ME61G
	47	F61	50	1,300	HHXD250ARA470MF61G
	56	F61	50	1,300	HHXD250ARA560MF61G
	68	F80	30	2,000	HHXD250ARA680MF80G
	100	F80	30	2,000	HHXD250ARA101MF80G
	150	HA0	27	2,300	HHXD250ARA151MHA0G
	220	HA0	27	2,300	HHXD250ARA221MHA0G
	270	JA0	20	2,500	HHXD250ARA271MJA0G
35	330	JA0	20	2,500	HHXD250ARA331MJA0G
	22	E61	100	900	HHXD350ARA220ME61G
	27	F61	60	1,300	HHXD350ARA270MF61G
	47	F61	60	1,300	HHXD350ARA470MF61G
	47	F80	35	2,000	HHXD350ARA470MF80G
	68	F80	35	2,000	HHXD350ARA680MF80G
	100	HA0	27	2,300	HHXD350ARA101MHA0G
	150	HA0	27	2,300	HHXD350ARA151MHA0G
50	150	JA0	20	2,500	HHXD350ARA151MJA0G
	270	JA0	20	2,500	HHXD350ARA271MJA0G
	10	E61	120	750	HHXD500ARA100ME61G
	10	F61	80	1,100	HHXD500ARA100MF61G
	15	F80	40	1,600	HHXD500ARA150MF80G
	22	F61	80	1,100	HHXD500ARA220MF61G
	33	F80	40	1,600	HHXD500ARA330MF80G
	33	HA0	30	1,800	HHXD500ARA330MHA0G
63	47	HA0	30	1,800	HHXD500ARA470MHA0G
	56	JA0	25	2,000	HHXD500ARA560MJA0G
	68	HA0	30	1,800	HHXD500ARA680MHA0G
	100	JA0	25	2,000	HHXD500ARA101MJA0G
	120	JA0	25	2,000	HHXD500ARA121MJA0G
	6.8	F61	120	1,000	HHXD630ARA6R8MF61G
	10	F61	120	1,000	HHXD630ARA100MF61G
	10	F80	80	1,500	HHXD630ARA100MF80G
63	22	F80	80	1,500	HHXD630ARA220MF80G
	22	HA0	40	1,600	HHXD630ARA220MHA0G
	33	HA0	40	1,600	HHXD630ARA330MHA0G
	33	JA0	30	1,800	HHXD630ARA330MJA0G
	47	HA0	40	1,600	HHXD630ARA470MHA0G
	56	JA0	30	1,800	HHXD630ARA560MJA0G
	82	JA0	30	1,800	HHXD630ARA820MJA0G

Product specifications in this catalog are subject to change without notice. Request our product specifications before purchase and/or use. Please use our products based on the information contained in this catalog and product specifications.

Return Group Chart



CONDUCTIVE POLYMER HYBRID ALUMINUM ELECTROLYTIC CAPACITORS

Surface Mount

HXA Series

- High reliability and high voltage are realized by hybrid electrolyte
- Endurance with ripple current : 4,000 hours at 125°C
- For high temperature and high reliability applications.
(Automotive equipment, Base station equipment, etc.)
- RoHS Compliant
- Halogen Free
- AEC-Q200 compliant : Please contact Chemi-Con for more details, test data, information.

HXA

Higher temperature
HXB P78



SPECIFICATIONS

Items	Characteristics							
Category								
Temperature Range	-55 to +125°C							
Rated Voltage Range	16 to 80V _{dc}							
Capacitance Tolerance	±20% (M) (at 20°C, 120Hz)							
Leakage Current	I=0.01CV Where, I : Max. leakage current (μA), C: Nominal capacitance(μF), V : Rated voltage(V) (at 20°C after 2 minutes)							
Dissipation Factor (tan δ)	Rated voltage(V _{dc})	16V	25V	35V	50V	63V	80V	
	tan δ (Max.)	0.16	0.14	0.12	0.10	0.08	0.08	(at 20°C, 120Hz)
Low Temperature Characteristics (Max. Impedance Ratio)	Z(-25°C)/Z(+20°C) ≤ 1.5 Z(-55°C)/Z(+20°C) ≤ 2.0 (at 100kHz)							
Endurance	The following specifications shall be satisfied when the capacitors are restored to 20°C after subjected to DC voltage with the rated ripple current is applied (the peak voltage shall not exceed the rated voltage) for 4,000 hours at 125°C.							
	Capacitance change	≤ ±30% of the initial value						
	D.F. (tan δ)	≤ 200% of the initial specified value						
	ESR	≤ 200% of the initial specified value						
	Leakage current	≤ The initial specified value						
Shelf Life	The following specifications shall be satisfied when the capacitors are restored to 20°C after exposing them for 1,000 hours at 125°C without voltage applied. Before the measurement, the capacitor shall be preconditioned by applying voltage according to item 4.1 of JIS C 5101-4.							
	Capacitance change	≤ ±30% of the initial value						
	D.F. (tan δ)	≤ 200% of the initial specified value						
	ESR	≤ 200% of the initial specified value						
	Leakage current	≤ The initial specified value						

DIMENSIONS [mm]

Terminal Code : A

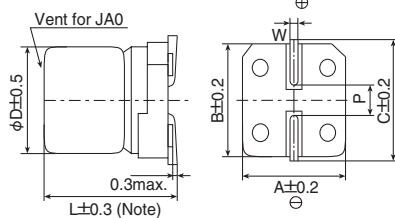

Note : L±0.5 for HA0 and JA0

Size Code	φD	L	A	B	C	W	P
F61	6.3	5.8	6.6	6.6	7.2	0.5 to 0.8	1.9
F80	6.3	7.7	6.6	6.6	7.2	0.5 to 0.8	1.9
HA0	8	10.0	8.3	8.3	9.0	0.7 to 1.1	3.1
JA0	10	10.0	10.3	10.3	11.0	0.7 to 1.1	4.5

MARKING

EX) 35V47μF



Rated voltage symbol

Rated voltage (V _{dc})	Symbol
16	C
25	E
35	V
50	H
63	J
80	K

PART NUMBERING SYSTEM

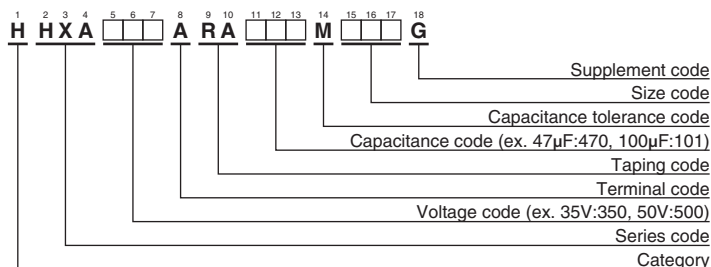

Please refer to "Product code guide (conductive polymer hybrid type)"

Return Group Chart



CONDUCTIVE POLYMER HYBRID ALUMINUM ELECTROLYTIC CAPACITORS

Surface Mount

HXA Series

◆ STANDARD RATINGS

WV (V _{dc})	Cap (μF)	Size code	ESR (mΩ max./20°C, 100kHz)	Rated ripple current (mA _{rms} /125°C, 100kHz)	Part No.
16	82	F61	45	950	HHXA160ARA820MF61G
	150	F80	27	1,450	HHXA160ARA151MF80G
	270	HA0	22	1,700	HHXA160ARA271MHA0G
	470	JA0	18	2,100	HHXA160ARA471MJA0G
25	47	F61	50	900	HHXA250ARA470MF61G
	56	F61	50	900	HHXA250ARA560MF61G
	68	F80	30	1,400	HHXA250ARA680MF80G
	100	F80	30	1,400	HHXA250ARA101MF80G
	150	HA0	27	1,600	HHXA250ARA151MHA0G
	220	HA0	27	1,600	HHXA250ARA221MHA0G
	270	JA0	20	2,000	HHXA250ARA271MJA0G
	330	JA0	20	2,000	HHXA250ARA331MJA0G
35	27	F61	60	900	HHXA350ARA270MF61G
	47	F61	60	900	HHXA350ARA470MF61G
	47	F80	35	1,400	HHXA350ARA470MF80G
	68	F80	35	1,400	HHXA350ARA680MF80G
	100	HA0	27	1,600	HHXA350ARA101MHA0G
	150	HA0	27	1,600	HHXA350ARA151MHA0G
	150	JA0	20	2,000	HHXA350ARA151MJA0G
	270	JA0	20	2,000	HHXA350ARA271MJA0G
50	10	F61	80	750	HHXA500ARA100MF61G
	15	F80	40	1,100	HHXA500ARA150MF80G
	22	F61	80	750	HHXA500ARA220MF61G
	33	F80	40	1,100	HHXA500ARA330MF80G
	33	HA0	30	1,250	HHXA500ARA330MHA0G
	47	HA0	30	1,250	HHXA500ARA470MHA0G
	56	JA0	25	1,600	HHXA500ARA560MJA0G
	68	HA0	30	1,250	HHXA500ARA680MHA0G
	100	JA0	25	1,600	HHXA500ARA101MJA0G
63	6.8	F61	120	700	HHXA630ARA6R8MF61G
	10	F61	120	700	HHXA630ARA100MF61G
	10	F80	80	900	HHXA630ARA100MF80G
	22	F80	80	900	HHXA630ARA220MF80G
	22	HA0	40	1,100	HHXA630ARA220MHA0G
	33	HA0	40	1,100	HHXA630ARA330MHA0G
	33	JA0	30	1,400	HHXA630ARA330MJA0G
	56	JA0	30	1,400	HHXA630ARA560MJA0G
	80	22	HA0	45	1,100
39		JA0	35	1,200	HHXA800ARA390MJA0G

Return Group Chart



CONDUCTIVE POLYMER HYBRID ALUMINUM ELECTROLYTIC CAPACITORS

Surface Mount

HXB Series

- High reliability and high voltage are realized by hybrid electrolyte
- Endurance with ripple current : 5,000 hours at 105°C
- For high reliability applications.
(Automotive equipment, Base station equipment, etc.)
- RoHS Compliant
- Halogen Free
- AEC-Q200 compliant : Please contact Chemi-Con for more details, test data, information.

HXA P76

↑ Higher temperature

HXB



SPECIFICATIONS

Items	Characteristics							
Category	-55 to +105°C							
Temperature Range	-55 to +105°C							
Rated Voltage Range	16 to 80V _{dc}							
Capacitance Tolerance	±20% (M) (at 20°C, 120Hz)							
Leakage Current	I=0.01CV Where, I : Max. leakage current (μA), C: Nominal capacitance(μF), V : Rated voltage(V) (at 20°C after 2 minutes)							
Dissipation Factor (tan δ)	Rated voltage(V _{dc})	16V	25V	35V	50V	63V	80V	
	tan δ (Max.)	0.16	0.14	0.12	0.10	0.08	0.08	(at 20°C, 120Hz)
Low Temperature Characteristics (Max. Impedance Ratio)	Z(-25°C)/Z(+20°C) ≤ 1.5 Z(-55°C)/Z(+20°C) ≤ 2.0 (at 100kHz)							
Endurance	The following specifications shall be satisfied when the capacitors are restored to 20°C after subjected to DC voltage with the rated ripple current is applied (the peak voltage shall not exceed the rated voltage) for 5,000 hours at 105 °C.							
	Capacitance change	≤ ±30% of the initial value						
	D.F. (tan δ)	≤ 200% of the initial specified value						
	ESR	≤ 200% of the initial specified value						
	Leakage current	≤ The initial specified value						
Shelf Life	The following specifications shall be satisfied when the capacitors are restored to 20°C after exposing them for 1,000 hours at 105 °C without voltage applied. Before the measurement, the capacitor shall be preconditioned by applying voltage according to item 4.1 of JIS C 5101-4.							
	Capacitance change	≤ ±30% of the initial value						
	D.F. (tan δ)	≤ 200% of the initial specified value						
	ESR	≤ 200% of the initial specified value						
	Leakage current	≤ The initial specified value						

DIMENSIONS [mm]

Terminal Code : A

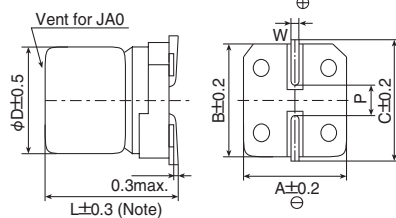

Note : L±0.5 for HA0 and JA0

Size Code	φD	L	A	B	C	W	P
F61	6.3	5.8	6.6	6.6	7.2	0.5 to 0.8	1.9
F80	6.3	7.7	6.6	6.6	7.2	0.5 to 0.8	1.9
HA0	8	10.0	8.3	8.3	9.0	0.7 to 1.1	3.1
JA0	10	10.0	10.3	10.3	11.0	0.7 to 1.1	4.5

MARKING

EX) 35V47μF



Rated voltage symbol

Rated voltage (V _{dc})	Symbol
16	C
25	E
35	V
50	H
63	J
80	K

PART NUMBERING SYSTEM

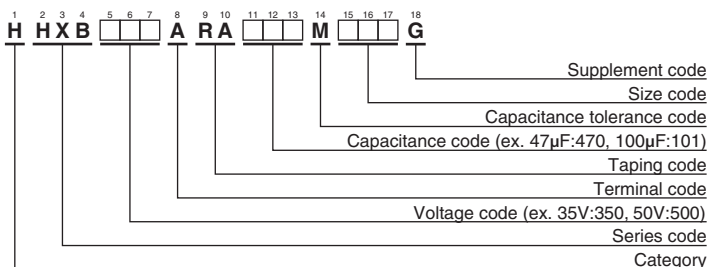

Please refer to "Product code guide (conductive polymer hybrid type)"

Return Group Chart



CONDUCTIVE POLYMER HYBRID ALUMINUM ELECTROLYTIC CAPACITORS

Surface Mount

HXB Series

◆ STANDARD RATINGS

WV (V _{dc})	Cap (μF)	Size code	ESR (mΩ max./20°C, 100kHz)	Rated ripple current (mA _{rms} /105°C, 100kHz)	Part No.
16	82	F61	45	1,600	HHXB160ARA820MF61G
	150	F80	27	2,200	HHXB160ARA151MF80G
	270	HA0	22	2,500	HHXB160ARA271MHA0G
	470	JA0	18	2,600	HHXB160ARA471MJA0G
25	47	F61	50	1,300	HHXB250ARA470MF61G
	56	F61	50	1,300	HHXB250ARA560MF61G
	68	F80	30	2,000	HHXB250ARA680MF80G
	100	F80	30	2,000	HHXB250ARA101MF80G
	150	HA0	27	2,300	HHXB250ARA151MHA0G
	220	HA0	27	2,300	HHXB250ARA221MHA0G
	270	JA0	20	2,500	HHXB250ARA271MJA0G
	330	JA0	20	2,500	HHXB250ARA331MJA0G
35	27	F61	60	1,300	HHXB350ARA270MF61G
	47	F61	60	1,300	HHXB350ARA470MF61G
	47	F80	35	2,000	HHXB350ARA470MF80G
	68	F80	35	2,000	HHXB350ARA680MF80G
	100	HA0	27	2,300	HHXB350ARA101MHA0G
	150	HA0	27	2,300	HHXB350ARA151MHA0G
	150	JA0	20	2,500	HHXB350ARA151MJA0G
	270	JA0	20	2,500	HHXB350ARA271MJA0G
50	10	F61	80	1,100	HHXB500ARA100MF61G
	15	F80	40	1,600	HHXB500ARA150MF80G
	22	F61	80	1,100	HHXB500ARA220MF61G
	33	F80	40	1,600	HHXB500ARA330MF80G
	33	HA0	30	1,800	HHXB500ARA330MHA0G
	47	HA0	30	1,800	HHXB500ARA470MHA0G
	56	JA0	25	2,000	HHXB500ARA560MJA0G
	68	HA0	30	1,800	HHXB500ARA680MHA0G
	100	JA0	25	2,000	HHXB500ARA101MJA0G
63	6.8	F61	120	1,000	HHXB630ARA6R8MF61G
	10	F61	120	1,000	HHXB630ARA100MF61G
	10	F80	80	1,500	HHXB630ARA100MF80G
	22	F80	80	1,500	HHXB630ARA220MF80G
	22	HA0	40	1,600	HHXB630ARA220MHA0G
	33	HA0	40	1,600	HHXB630ARA330MHA0G
	33	JA0	30	1,800	HHXB630ARA330MJA0G
	56	JA0	30	1,800	HHXB630ARA560MJA0G
	80	22	HA0	45	1,600
39		JA0	35	1,700	HHXB800ARA390MJA0G

Return Group Chart



CONDUCTIVE POLYMER HYBRID ALUMINUM ELECTROLYTIC CAPACITORS

Radial Lead

HSC Series New!

- High reliability and high voltage are realized by hybrid electrolyte
- Endurance with ripple current : 4,000 hours at 125°C
- Rated voltage range : 25 to 63V_{dc}, Capacitance range : 100 to 330μF
- For high temperature and high reliability applications.
(Automotive equipment, Base station equipment, etc.)
- RoHS Compliant
- Halogen Free
- AEC-Q200 compliant : Please contact Chemi-Con for more details, test data, information.

HSC

Higher temperature
HSD P82

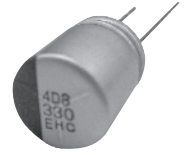

SPECIFICATIONS

Items	Characteristics										
Category											
Temperature Range	-55 to +125°C										
Rated Voltage Range	25 to 63V _{dc}										
Capacitance Tolerance	±20% (M) (at 20°C, 120Hz)										
Leakage Current	I=0.05CV Where, I : Max. leakage current (μA), C: Nominal capacitance(μF), V : Rated voltage(V) (at 20°C after 2 minutes)										
Dissipation Factor (tan δ)	0.16 max. (at 20°C, 120Hz)										
Low Temperature Characteristics (Max. Impedance Ratio)	Z(-25°C)/Z(+20°C) ≤ 1.5 Z(-55°C)/Z(+20°C) ≤ 2.0 (at 100kHz)										
Endurance	The following specifications shall be satisfied when the capacitors are restored to 20°C after subjected to DC voltage with the rated ripple current is applied (the peak voltage shall not exceed the rated voltage) for 4,000 hours at 125°C. <table border="1"> <tr> <td>Capacitance change</td> <td>≤ ±30% of the initial value</td> </tr> <tr> <td>D.F. (tan δ)</td> <td>≤ 200% of the initial specified value</td> </tr> <tr> <td>ESR</td> <td>≤ 200% of the initial specified value</td> </tr> <tr> <td>Leakage current</td> <td>≤ The initial specified value</td> </tr> </table>	Capacitance change	≤ ±30% of the initial value	D.F. (tan δ)	≤ 200% of the initial specified value	ESR	≤ 200% of the initial specified value	Leakage current	≤ The initial specified value		
Capacitance change	≤ ±30% of the initial value										
D.F. (tan δ)	≤ 200% of the initial specified value										
ESR	≤ 200% of the initial specified value										
Leakage current	≤ The initial specified value										
Shelf Life	The following specifications shall be satisfied when the capacitors are restored to 20°C after exposing them for 1,000 hours at 125°C without voltage applied. Before the measurement, the capacitor shall be preconditioned by applying voltage according to item 4.1 of JIS C 5101-4. <table border="1"> <tr> <td>Capacitance change</td> <td>≤ ±30% of the initial value</td> </tr> <tr> <td>D.F. (tan δ)</td> <td>≤ 200% of the initial specified value</td> </tr> <tr> <td>ESR</td> <td>≤ 200% of the initial specified value</td> </tr> <tr> <td>Leakage current</td> <td>≤ The initial specified value</td> </tr> </table>	Capacitance change	≤ ±30% of the initial value	D.F. (tan δ)	≤ 200% of the initial specified value	ESR	≤ 200% of the initial specified value	Leakage current	≤ The initial specified value		
Capacitance change	≤ ±30% of the initial value										
D.F. (tan δ)	≤ 200% of the initial specified value										
ESR	≤ 200% of the initial specified value										
Leakage current	≤ The initial specified value										
Bias Humidity Test	The following specifications shall be satisfied when the capacitors are restored to 20°C after subjecting them to the DC rated voltage at 85°C, 85% RH for 2,000 hours. <table border="1"> <tr> <td>Appearance</td> <td>No significant damage</td> </tr> <tr> <td>Capacitance change</td> <td>≤ ±30% of the initial value</td> </tr> <tr> <td>D.F. (tan δ)</td> <td>≤ 200% of the initial specified value</td> </tr> <tr> <td>ESR</td> <td>≤ 200% of the initial specified value</td> </tr> <tr> <td>Leakage current</td> <td>≤ The initial specified value</td> </tr> </table>	Appearance	No significant damage	Capacitance change	≤ ±30% of the initial value	D.F. (tan δ)	≤ 200% of the initial specified value	ESR	≤ 200% of the initial specified value	Leakage current	≤ The initial specified value
Appearance	No significant damage										
Capacitance change	≤ ±30% of the initial value										
D.F. (tan δ)	≤ 200% of the initial specified value										
ESR	≤ 200% of the initial specified value										
Leakage current	≤ The initial specified value										

DIMENSIONS [mm]

Terminal Code : E

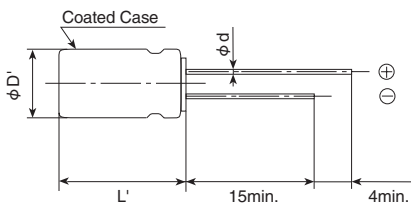

Size Code	JC5
φD	10
φd	0.6
F	5.0
φD'	φD+0.5max.
L'	L+1.5max.

MARKING

EX) 25V330μF



Rated voltage symbol

Rated voltage (V _{dc})	Symbol
25	E
35	V
50	H
63	J

PART NUMBERING SYSTEM

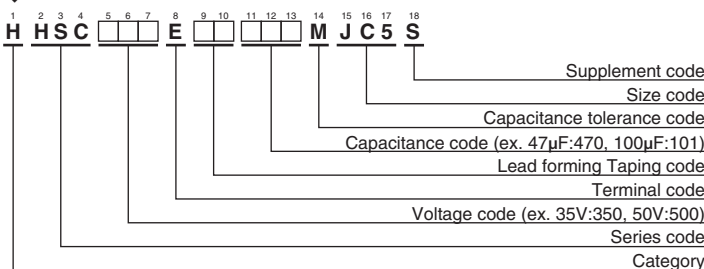

Please refer to "Product code guide (conductive polymer hybrid type)"

Return Group Chart



CONDUCTIVE POLYMER HYBRID ALUMINUM ELECTROLYTIC CAPACITORS

Radial Lead



◆STANDARD RATINGS

WV (V _{dc})	Cap (μ F)	Case size ϕ D×L (mm)	ESR (m Ω max./20°C, 100kHz)	Rated ripple current (mA _{rms} /125°C, 100kHz)	Part No.
25	330	10×12.5	16	2,300	HHSC250E□□331MJC5S
35	270	10×12.5	17	2,200	HHSC350E□□271MJC5S
50	120	10×12.5	19	2,100	HHSC500E□□121MJC5S
63	100	10×12.5	20	2,000	HHSC630E□□101MJC5S

□□:Enter the appropriate lead forming or taping code.

Return Group Chart



CONDUCTIVE POLYMER HYBRID ALUMINUM ELECTROLYTIC CAPACITORS

Radial Lead

HSD Series New!

- High reliability and high voltage are realized by hybrid electrolyte
- Endurance with ripple current : 5,000 hours at 105°C
- Rated voltage range : 25 to 63V_{dc}, Capacitance range : 100 to 330μF
- For high reliability applications.
(Automotive equipment, Base station equipment, etc.)
- RoHS Compliant
- Halogen Free
- AEC-Q200 compliant : Please contact Chemi-Con for more details, test data, information.

HSC P80

↑ Higher temperature

HSD



SPECIFICATIONS

Items	Characteristics										
Category Temperature Range	-55 to +105°C										
Rated Voltage Range	25 to 63V _{dc}										
Capacitance Tolerance	±20% (M) (at 20°C, 120Hz)										
Leakage Current	I=0.05CV Where, I : Max. leakage current (μA), C: Nominal capacitance(μF), V : Rated voltage(V) (at 20°C after 2 minutes)										
Dissipation Factor (tan δ)	0.16 max. (at 20°C, 120Hz)										
Low Temperature Characteristics (Max. Impedance Ratio)	Z(-25°C)/Z(+20°C) ≤ 1.5 Z(-55°C)/Z(+20°C) ≤ 2.0 (at 100kHz)										
Endurance	The following specifications shall be satisfied when the capacitors are restored to 20°C after subjected to DC voltage with the rated ripple current is applied (the peak voltage shall not exceed the rated voltage) for 5,000 hours at 105 °C. <table border="1"> <tr> <td>Capacitance change</td> <td>≤ ±30% of the initial value</td> </tr> <tr> <td>D.F. (tan δ)</td> <td>≤ 200% of the initial specified value</td> </tr> <tr> <td>ESR</td> <td>≤ 200% of the initial specified value</td> </tr> <tr> <td>Leakage current</td> <td>≤ The initial specified value</td> </tr> </table>	Capacitance change	≤ ±30% of the initial value	D.F. (tan δ)	≤ 200% of the initial specified value	ESR	≤ 200% of the initial specified value	Leakage current	≤ The initial specified value		
Capacitance change	≤ ±30% of the initial value										
D.F. (tan δ)	≤ 200% of the initial specified value										
ESR	≤ 200% of the initial specified value										
Leakage current	≤ The initial specified value										
Shelf Life	The following specifications shall be satisfied when the capacitors are restored to 20°C after exposing them for 1,000 hours at 105 °C without voltage applied. Before the measurement, the capacitor shall be preconditioned by applying voltage according to item 4.1 of JIS C 5101-4. <table border="1"> <tr> <td>Capacitance change</td> <td>≤ ±30% of the initial value</td> </tr> <tr> <td>D.F. (tan δ)</td> <td>≤ 200% of the initial specified value</td> </tr> <tr> <td>ESR</td> <td>≤ 200% of the initial specified value</td> </tr> <tr> <td>Leakage current</td> <td>≤ The initial specified value</td> </tr> </table>	Capacitance change	≤ ±30% of the initial value	D.F. (tan δ)	≤ 200% of the initial specified value	ESR	≤ 200% of the initial specified value	Leakage current	≤ The initial specified value		
Capacitance change	≤ ±30% of the initial value										
D.F. (tan δ)	≤ 200% of the initial specified value										
ESR	≤ 200% of the initial specified value										
Leakage current	≤ The initial specified value										
Bias Humidity Test	The following specifications shall be satisfied when the capacitors are restored to 20°C after subjecting them to the DC rated voltage at 85°C, 85% RH for 2,000 hours. <table border="1"> <tr> <td>Appearance</td> <td>No significant damage</td> </tr> <tr> <td>Capacitance change</td> <td>≤ ±30% of the initial value</td> </tr> <tr> <td>D.F. (tan δ)</td> <td>≤ 200% of the initial specified value</td> </tr> <tr> <td>ESR</td> <td>≤ 200% of the initial specified value</td> </tr> <tr> <td>Leakage current</td> <td>≤ The initial specified value</td> </tr> </table>	Appearance	No significant damage	Capacitance change	≤ ±30% of the initial value	D.F. (tan δ)	≤ 200% of the initial specified value	ESR	≤ 200% of the initial specified value	Leakage current	≤ The initial specified value
Appearance	No significant damage										
Capacitance change	≤ ±30% of the initial value										
D.F. (tan δ)	≤ 200% of the initial specified value										
ESR	≤ 200% of the initial specified value										
Leakage current	≤ The initial specified value										

DIMENSIONS [mm]

- Terminal Code : E

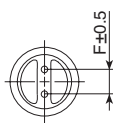
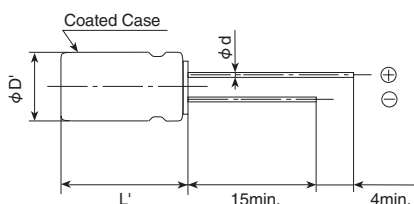

Size Code	JC5
φD	10
φd	0.6
F	5.0
φD'	φD+0.5max.
L'	L+1.5max.

MARKING

EX) 25V330μF



- Rated voltage symbol

Rated voltage (V _{dc})	Symbol
25	E
35	V
50	H
63	J

PART NUMBERING SYSTEM

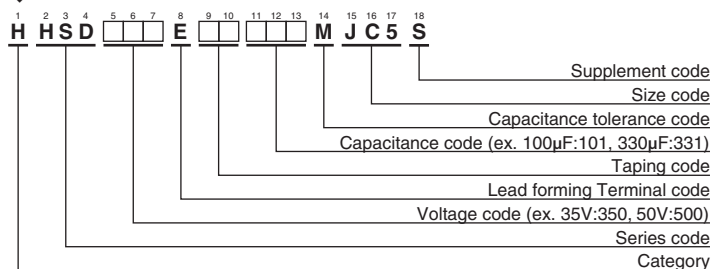

Please refer to "Product code guide (conductive polymer hybrid type)"

Return Group Chart



CONDUCTIVE POLYMER HYBRID ALUMINUM ELECTROLYTIC CAPACITORS

Radial Lead



◆STANDARD RATINGS

WV (V _{dc})	Cap (μF)	Case size φ D×L (mm)	ESR (mΩ max./20°C, 100kHz)	Rated ripple current (mA _{rms} /105°C, 100kHz)	Part No.
25	330	10×12.5	16	3,100	HHSD250E□□331MJC5S
35	270	10×12.5	17	3,000	HHSD350E□□271MJC5S
50	120	10×12.5	19	2,800	HHSD500E□□121MJC5S
63	100	10×12.5	20	2,600	HHSD630E□□101MJC5S

□□:Enter the appropriate lead forming or taping code.

Aluminum Electrolytic Capacitors



Precautions and Guidelines (Aluminum Electrolytic Capacitors)

For Conductive Polymer Aluminum Solid Electrolytic Capacitors, see Precautions and Guidelines (Conductive Polymer).

For Conductive Polymer Hybrid Aluminum Electrolytic Capacitors, see Precautions and Guidelines (Conductive Polymer Hybrid).

1) Device circuits design considerations

1) Confirm installation and operating requirements for capacitors, then use them within the performance limits prescribed in this catalog or product specifications.

2) Polarity

Aluminum electrolytic capacitors are polarized. Never apply a reverse voltage or AC voltage. Connecting with wrong polarity will short-circuit or damage the capacitor with the pressure relief vent opening early on. To identify the polarity of a capacitor, see the relevant diagram in the catalogs or product specifications, or the polarity marking on the body of the capacitor. Incidentally, the rubber end seal bungs of the radial lead type capacitors have a solder-flux gas escaping configuration, which is nothing to do with the polarity of the capacitors. For circuits where the polarity is occasionally reversed, use a bi-polar type of aluminum electrolytic capacitor. However, note that even bi-polar type capacitors must not be used for AC circuits.

3) Operating voltage

Do not apply an over-voltage that exceeds a rated voltage specified for the capacitors. The total peak value of the ripple voltage plus the DC voltage must not exceed the rated voltage of the capacitors. Although capacitors specify a surge voltage that exceeds the full rated voltage, it does not assure long-term use but limited use under specific conditions.

4) Ripple current

Do not apply an overcurrent that exceeds the rated ripple current specified for the capacitors. Excessive ripple current will increase heat production within the capacitors, causing the capacitors to be damaged as follows:

- Shorten lifetime
- Open pressure relief vent
- Short circuit

The rated ripple current is specified along with a specific ripple frequency.

When using the capacitors at any other ripple frequency other than the specified frequency, calculate the allowable ripple current by multiplying the rated ripple current by a frequency compensation factor (Frequency Multiplier) specified for each product series.

5) Operating temperature (Category temperature)

Do not apply high temperatures that exceed the upper limit of the category temperature range specified for the capacitors.

Using the capacitor at temperatures higher than the upper limit will considerably shorten the lifetime of the capacitor and make the pressure relief vent open.

In other words, lowering ambient temperatures will extend the expected lifetime of the capacitors.

6) Lifetime

Select the capacitors to meet the service life requirements of a device.

7) Charging and discharging

Do not use capacitors in circuits intended for rapid charge and discharge cycle operations.

If capacitors are used in the circuits that repeat a charge and discharge with a large voltage drop or a rapid charge and discharge at a short interval cycle, capacitance will decrease and/or the capacitors will be damaged by internal heat generation.

Consult us for a heavy charge and discharge type of capacitor so that the capacitor will be designed in accordance with requirements of duty cycle of charge and discharge, the number of cycles, discharging resistance and operating temperatures.

8) Failure mode of capacitors

Non-solid aluminum electrolytic capacitors have a limited lifetime which ends in an open circuit failure mode, in general. Depending on the product type and operating conditions, the failure mode may involve in opening of the pressure relief vent.

9) Capacitor insulation

Electrically isolate the following sections of a capacitor from the negative terminal, the positive terminal and the circuit patterns.

- The outer can case of a non-solid aluminum capacitor.
- The dummy terminal of a snap-in type non-solid aluminum capacitor, which is designed for mounting stability.

10) Outer sleeve

The outer sleeve of a capacitor does not assure electrical insulation (except for screw-terminal type capacitors). It should not be used where electrical insulation is required.

11) Operating conditions

Do not use/expose capacitors to the following conditions:

- ① Direct contact with water, salt water or oil, or high condensation environment.
- ② Direct sunlight.
- ③ Toxic gases such as hydrogen sulfide, sulfurous acid, nitrous acid, chlorine and its compounds, bromine and its compounds and ammonium.
- ④ Ozone, ultraviolet rays or radiation.
- ⑤ Extreme vibration or mechanical shock that exceeds limits in the catalogs or product specifications.

The standard vibration condition is applicable to JIS C 5101-4.

12) Mounting

① Non-solid aluminum electrolytic capacitors contain paper separators and electric-conductive electrolyte that contains organic solvent as main solvent material, both of which are flammable. If the electrolyte leaks onto a printed circuit board, it can erode the device circuit pattern, may short-circuit the copper traces, smoke and burn. Make sure of designing a PC board as follows:

- Provide the appropriate hole spacing on the PC board to match the terminal spacing of a capacitor.
- Provide the following adequate clearance space over the pressure relief vent of a capacitor to avoid blocking the correct opening of the pressure relief vent.

Case diameter	Clearance
φ 8(6.3) to φ 16mm:	2mm minimum
φ 18 to φ 35mm:	3mm minimum
φ 40 mm and above:	5mm minimum

- Do not locate any wire or circuit pattern over the pressure relief vent of a capacitor.
 - If a capacitor is mounted with its pressure relief vent facing down on the PC board, provide a ventilation hole in the board beneath it to let gas escape when the vent opens.
 - Do not print any copper trace under the seal (terminal) side of a capacitor. Copper traces should be 1 mm (preferably 2mm or more) spaced apart from the side of the capacitor body.
 - Avoid locating any heat source components near capacitors or on the opposite side of the PC board under capacitors.
 - In designing a double-sided PC board, do not locate any through-hole via or unnecessary hole underneath a capacitor.
 - In designing a double-sided PC board, do not print any circuit pattern underneath a capacitor.
- ② For a screw terminal type capacitor, tightening the terminal screws and the mounting clamp should be within the maximum torque specified in the catalogs or product specifications. Do not mount a screw terminal type capacitor with the terminals facing downward. Also, if the body of a capacitor is installed horizontally such as being laid on its side, do not position the pressure relief vent downward.
- ③ For a chip type capacitor, design the land patterns of the PC board in accordance with the recommended footprint dimensions described in the catalogs or product specifications.



Precautions and Guidelines (Aluminum Electrolytic Capacitors)

13) Using capacitors for significantly safety-oriented applications

Consult us about capacitors for a device application affecting human safety (①Aviation and aerospace ②Nuclear ③Medical ④Vehicle) or for any device whose failure will make an impact on society. Note that some products such as photoflash use capacitors which have been designed for specific applications cannot be used for any other application.

14) Others

Design device circuits taking into consideration the following conditions:

- ① Electrical characteristics of a capacitor depend on the temperature and frequency. In designing the device circuits, consider the change in the characteristics.
- ② If using more than one capacitor connected in parallel, design the device circuits to balance the current flow in individual capacitors.
- ③ If using more than one capacitor connected in series, connect shunting resistors in parallel with the individual capacitors to balance the voltage.

2 Installation

1) Assembling

- ① Do not try to reuse the capacitors once assembled and electrified, except only capacitors that are taken from a device for periodic inspection to measure their electrical characteristics.
- ② Capacitors may have been spontaneously recharged with time by a recovery voltage phenomenon. In this case, discharge the capacitors through a resistor of approximately 1kΩ before use.
- ③ If non-solid aluminum electrolytic capacitors have been stored at any conditions more than 35°C and 75%RH for long storage periods of time more than the limits specified in the catalogs or product specifications, they may have high leakage current. In this case, make pre-conditioning by applying the rated voltage through a resistor of approximately 1kΩ.
- ④ Confirm the rated capacitance and voltage of capacitors before installation.
- ⑤ Confirm the polarity of capacitors before installation.
- ⑥ Do not try to use the capacitors that were dropped to the floor and so forth.
- ⑦ Do not deform the can case of a capacitor.
- ⑧ Make sure that the terminal spacing of a capacitor equals the holes spacing on the PC board before installing the capacitor. For radial lead type capacitors, some standard pre-formed lead types are also available.
- ⑨ When installing a snap-in type capacitor on the PC board, insert the terminals into the holes and press the capacitor down until the body is settled flush on the surface of the PC board (without the body standing off).
- ⑩ Do not apply excessive mechanical force to capacitors more than the limits prescribed in the catalogs or product specifications. Avoid excessive mechanical force while the capacitors are in the process of vacuum-picking, placing and positioning by automatic mounting machines or cutting the lead wires by automatic insertion machines.

2) Soldering and heat resistance

- ① For soldering using a soldering iron, consider the following conditions:
 - Soldering conditions (temperature and time) should be within the limits prescribed in the catalogs or product specifications.
 - If it is necessary to pre-form the terminal spacing of a capacitor to match the hole spacing on the PC board before assembly and soldering, do not make mechanical stress reach into the body of the capacitor but only the lead wires.
 - Do not touch the body of a capacitor with the hot tip of the soldering iron.
- ② For flow soldering, consider the following conditions:
 - Do not dip the body of a capacitor into a solder bath. Expose only the terminals to the melt solder with the PC board interposing between the solder and the body of the capacitor. Solder only the reverse side of the PC board where the body of the capacitor is not located.
 - Soldering conditions should be within the limits prescribed

in the catalogs or product specifications.

- Do not apply flux to any part of a capacitor other than the terminals.
 - Do not let any other component lean against nor come into contact with the capacitor while soldering.
- ③ For reflow soldering, consider the following conditions:
 - Soldering conditions (preheat, reflow temperature and time) should be within the limits prescribed in the catalogs or product specifications.
 - When using the infrared heater and setting its temperatures, adjust the heating levels taking into consideration that the color and materials of a capacitor vary in their infrared absorbance.
 - The allowable number of reflow passes is specified in the catalogs or product specifications.
 - When mounting a capacitor on the double-sided PC board, do not place any wiring pattern underneath the capacitor.
 - Please consult us about vapor phase soldering (VPS).
 - ④ Do not try to reuse the capacitor that was removed from the PC board after soldering.
 - ⑤ Only use chip type capacitors for reflow soldering. The other type capacitors are not designed for the reflow.

3) Handling after soldering

After soldering the PC board, do not apply the following mechanical stress to the capacitor:

- ① Do not tilt, push down or twist the body of the capacitor.
- ② Do not grab the body of the capacitor to carry the assembly board.
- ③ Do not hit anything against the capacitor. When stacking the assembled boards, do not put any of the PC boards or other components against the capacitor.
- ④ Do not drop the assembled board.

4) Cleaning assembly boards

- ① Do not clean capacitors with the following cleaning agents:
 - Halogenated solvents: cause capacitor failures due to corrosion.
 - Alkali system solvents: corrode (dissolve) the aluminum can case.
 - Terpene and petroleum system solvents: deteriorate the rubber seal materials.
 - Xylene: deteriorates the rubber seal materials as well.
 - Acetone: erases the markings printed on a capacitor.

Where cleaning is necessary, use only solvent resistant type capacitors that have been assured for the cleaning within the specific cleaning conditions prescriber in the catalogs or product specifications. In particular, carefully set up the conditions for ultrasonic cleaning system.
- ② Where cleaning the solvent resistance type of aluminum electrolytic capacitors, confirm the following conditions:
 - Control the contamination (the conductivity, pH, specific gravity, water content, etc.) of the cleaning agents.
 - After the cleaning, do not leave the capacitors (assembly boards) in an environment of cleaning agent-rich or in a closed container. Sufficiently evaporate the residual cleaning agent from the assembly boards and the capacitors by forced hot air at temperatures less than the upper limit of category temperature range for more than 10 minutes.

In general, aluminum electrolytic capacitors are sensitive to contamination of halogen ions (particularly to chlorine ions). Depending on the properties of the electrolyte and rubber seal materials used in a capacitor, the halogen ions lead up to catastrophic failures on the capacitor. Where the inside of a capacitor has been contaminated with more than a certain amount of halogen ions and the capacitor is in use, the corrosion reaction of aluminum occurs. The corrosion causes the capacitor to have a significant increase in leakage current with heat produced, open the pressure relief vent and become open circuit mode failure.

Due to global environmental issues (greenhouse effects and other environmental destruction by depletion of the ozone layer), the conventional cleaning solvents of CFC 113, Trichloroethylene and 1,1,1-trichloroethylene were replaced by substitutes.

The following are some substitute cleaning agents and allowable cleaning conditions:



Precautions and Guidelines (Aluminum Electrolytic Capacitors)

- a) Fatty-alcohol cleaning agents
 Pine Alpha ST-100S (Arakawa Chemical)
 Clean Through 750H, 750K, 750L and 710M (Kao)
 Technocare FRW-14, 15, 16 and 17 (Momentive Performance Materials)

[Cleaning conditions]

Either of immersion or ultrasonic cleaning, for a maximum of 10 minutes and at a maximum liquid temperature of 60°C is acceptable. Make sure that the markings on the capacitor are not rubbed against any other component or the PC board during cleaning. Note that shower cleaning affects the markings on the capacitor.

- b) HCFC (Freon 225) as Alternative CFCs
 AK225AES (Asahi Glass)

[Cleaning conditions]

Solvent resistant type capacitors, which were originally developed to intend to resist Freon TE or Freon TES, are also capable of withstanding any one of immersion, ultrasonic or vapor cleaning, for a maximum of 5 minutes (or 2 minutes for KRE and KRE-BP series capacitors or 3 minutes for SRM series). However, this type of cleaning agent is not recommended to use, as the cleaning materials may be banned in near future in view of global environmental issues.

- c) IPA (Isopropyl Alcohol)

Immersion cleaning with a maximum flux concentration of 2 wt% is acceptable.

5) Adhesives and coating materials

- ① Do not use any adhesive or coating materials containing halogenated solvents.
- ② Make sure of the following conditions before applying adhesive or coating materials to a capacitor,
 - No flux residue nor stain is left between the rubber seal of a capacitor and PC board.
 - Dry the capacitor to remove residual cleaning agents before applying adhesive and coating materials. Do not cover up the entire surface of the rubber seal of the capacitor with adhesives or coating materials.
 - Heating and curing conditions for adhesives and coating materials should be followed as prescribed in the catalogs or product specifications.
 - Covering up the entire surface of the rubber seal with resin mold materials will obstruct the normal diffusion of internal hydrogen gas from a capacitor and result in serious failures. Also, where the adhesive and coating materials contain a large amount of halogen ions, the halogen ions will contaminate the inside of the capacitor through the rubber seal materials, causing the capacitor to become a failure.
 - Depending on solvent materials that the adhesive or coating materials contains, note that the outer sleeve of a capacitor may lose a gloss or whiten in appearance.

6) Fumigation

In exporting or importing electronic devices, they may be exposed to fumigation with halide such as methyl bromide. Where aluminum electrolytic capacitors are exposed to halide such as methyl bromide, the capacitors will be damaged with the corrosion reaction with halogen ions in the same way as cleaning agents. For the export and import, Nippon Chemi-Con considers using some packaging method and so forth so that fumigation is not required. For customers to export or import electronic devices, semi-assembly products or capacitor components, confirm if they will be exposed to fumigation and also consider final condition of packaging. (Note that either cardboard or vinyl package has a risk of fumigation gas penetration.)

3 Precautions during operation of devices

- 1) Never touch the terminals of a capacitor directly with bare hands.
- 2) Do not short-circuit between the capacitor terminals with anything conductive.
 Also, do not spill any conductive liquid such as acid or alkaline solution over a capacitor.
- 3) Confirm environmental conditions where the device will be placed. Do not use the device in the following environmental conditions:
 - ① Water or oil spatters, or high condensation environment.
 - ② Direct sunlight.
 - ③ Ozone, ultraviolet rays or radiation.
 - ④ Toxic gases such as hydrogen sulfide, sulfuric acid, nitrous acid, chlorine and its compounds, bromine and its compounds and ammonium.
 - ⑤ Severe vibration or mechanical shock conditions beyond the limits prescribed in the catalog or product specification.
 The standard vibration condition is applicable to JIS C 5101-4.

4 Maintenance inspections

- 1) For industrial use capacitors, make periodic inspections of the capacitors. Before the inspections, turn off the power supply of the device and discharge the electricity of the capacitors. Where checking it by a volt-ohm meter, confirm the polarity beforehand. Do not apply mechanical stress to the terminals of the capacitors during inspection.
- 2) Characteristics to be inspected
 - ① Significant damage in appearance: vent opening, electrolyte leakage, etc.
 - ② Electrical characteristics: leakage current, capacitance, $\tan \delta$ and other characteristics prescribed in the catalogs or product specifications

If finding anything abnormal on the characteristics above, check the specifications of the capacitor and take appropriate actions such as replacement.

5 Capacitor venting

- 1) A capacitor with more than a certain case size has the pressure relief vent functioning to escape abnormal gas pressure increase.
 If gas expels from a venting capacitor, disconnect the power supply of the device or unplug the power supply cord. If not disconnecting the power supply, the device circuit may be damaged due to the short circuit failure of the capacitor or short-circuited with the liquid that the gas was condensed to. It may cause secondary damages such as device burnout in the worst case scenario.
 The gas that comes out of the open vent is vaporized electrolyte, not smoke.
- 2) The gas expelled from a venting capacitor is more than 100°C. Never expose your face to the capacitor. If your eyes are exposed to the gas or you inhale it, immediately flush your eyes and/or gargle with water. If the electrolyte comes in contact with the skin, wash with soap and water.

6 Storage

- 1) Do not store capacitors at high temperature or high humidity. Store the capacitors indoors at temperatures of 5 to 35°C and humidities of less than 75%RH.
 In principle, aluminum electrolytic capacitors should be used within three years after production.



Precautions and Guidelines (Aluminum Electrolytic Capacitors)

- 2) Keep capacitors packed in the original packaging material wherever possible.
- 3) Avoid the following storage environmental conditions:
 - ① Water spattering, high temperatures, high humidity or condensation environment.
 - ② Oil spattering or oil mist filled.
 - ③ Salt water spattering or salt filled.
 - ④ Acidic toxic gases such as hydrogen sulfide, sulfuric acid, nitrous acid, chlorine, bromine and methyl bromide filled.
 - ⑤ Alkaline toxic gases such as ammonium filled.
 - ⑥ Acid or alkaline solutions spattering.
 - ⑦ Direct sunlight, ozone, ultraviolet rays or radiation.
 - ⑧ Extreme vibration or shock loading.
- 4) JEDEC J-STD-020 is not applicable.

7 Capacitor disposal

Please consult with a local organization for the proper disposal of industrial waste. For incinerating capacitors, apply a high-temperature incineration (over 800°C). Incinerating them at temperatures lower than that may produce toxic gases such as chlorine. To prevent capacitors from explosion, punch holes in or sufficiently crush the can cases of the capacitors, then incinerate.

8 About AEC-Q200

The Automotive Electronics Council (AEC) was originally established by major American automotive related manufacturers. Today, the committees are composed of representatives from the sustaining Members of manufacturing companies in automotive electrical components. It has standardized the criteria for "stress test qualification" and "reliability tests" for electronic components.

AEC-Q200 is the reliability test standard for approval of passive components in Automotive applications. It specifies the test type, parameters and quantity, etc. for each component. The criteria of the reliability tests such as for our main products, "Aluminum Electrolytic Capacitors" are described in this standard.

Pursuant to the customer's specific testing requirements, Chemi-Con submits the test results according to AEC-Q200 for Aluminum Electrolytic Capacitors used in automotive applications on request.

An electronic component manufacturer cannot simply claim that their product is "AEC-Q200 Qualified". It can be claimed "Compliant", "Capable", "Available", etc., however each component must be tested per each users "Qualification Test Plan" in order to claim AEC-Q200 status.

Please contact us for more information.

9 Regarding compliance for EU REACH Regulation

- 1) According to the content of REACH handbook (Guidance on requirements for substances in articles which is published on May 2008), our electronic components are "articles without any intended release". Therefore they are not applicable for "Registration" for EU REACH Regulation Article 7 (1).

Reference: Electrolytic Condenser Investigation Society
 "Study of REACH Regulation in EU about Electrolytic Capacitor"
 (publicized on 13 March 2008)

- 2) Nippon Chemi-Con develops the products without substance of very high concern (SVHC). DEHP (CAS No. 117-81-7) was contained as some covering material, Nippon Chemi-Con abolished use of DEHP totally at June, 2011.

10 Catalogs

Specifications in the catalogs are subject to change without notice. Test data shown in the catalogs are not assured as the whole performance values, but typical values.

For more details, refer to JEITA RCR-2367C (March 2006) with the title of "Safety Application Guide for fixed aluminum electrolytic capacitors for use in electronic equipment".



RECOMMENDED SOLDERING CONDITIONS

◆ SURFACE MOUNT TYPE

Alchip™ MVA/MVE/MZR/MZJ/MZA/MVY/MZF/MZE/MZK/MLA/MLF/MLK/MVL/MVJ/MVH/MHL/MHB/MHJ/MHK/MKB/MV-BP/MVK-BP

The following conditions are recommended for air convection and infrared reflow soldering on the SMD products onto a glass epoxy circuit boards by cream solder. The dimensions of the glass epoxy boards with resist are 90×50×0.8mm for D55 to KG5 case code SMD capacitors and 180×90×0.8mm for LH0 to MN0 case codes SMD capacitors.

The temperatures shown are the surface temperature values on the top of the can and on the capacitor terminals.

Reflow should be performed twice or less.

Please ensure that the capacitor became cold enough to the room temperature (5 to 35°C) before the second reflow.

Consult with us when performing reflow profile in IPC / JEDEC (J-STD-020)

● Recommended soldering heat conditions (Except for Conductive Polymer Aluminum Solid Capacitors)

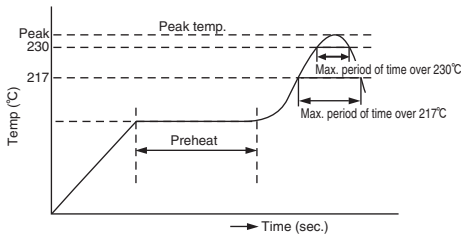

SMD type	Size code	Voltage range (V _{dc})	Preheat	Time maintained above 217°C	Time maintained above 230°C	Peak temp.	Reflow number
Vertical	D55 to F90	4 to 63V (Except 63V for MVH)	150 to 180°C 120sec. max.	90sec. max.	60sec. max.	260°Cmax.	2 times or less
		63V(MVH), 80V		60sec. max.	40sec. max.	250°Cmax.	2 times or less
	4 to 50V	60sec. max.		30sec. max.	245°Cmax.	2 times or less	
	63 to 100, 400V	30sec. max.		20sec. max.	240°Cmax.	2 times or less	
KE0 to MN0	6.3 to 50V	30sec. max.	20sec. max.	240°Cmax.	2 times or less		
	63 to 450V	20sec. max.	—	230°Cmax.	2 times or less		

● Recommended Solder Land on PC Board

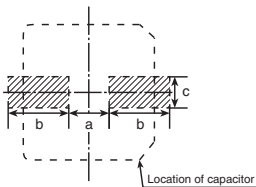

▨ : Solder land on PC board

Size code	Terminal code : A			Terminal code : G		
	a	b	c	a	b	c
D55, D60, D61, D73	1.0	2.6	1.6			
E55, E60, E61, E73	1.4	3.0	1.6			
F55, F60, F61, F73, F80, F90	1.9	3.5	1.6			
H63	2.3	4.5	1.6			
HA0	3.1	4.2	2.2	3.1	4.2	3.5
JA0	4.5	4.4	2.2	4.5	4.4	3.5
KE0, KG5	4.0	5.7	2.5	3.4	6.3	9.3
LH0, LN0	6.0	6.9	2.5	4.7	7.8	9.6
MH0, MN0	6.0	7.9	2.5	4.7	8.8	9.6

◆ RADIAL LEAD AND SNAP-IN TYPE

● Recommended soldering heat conditions

Flow soldering : 260±5°C for 10±1 seconds

Hand soldering : 380±10°C for 3±0.5 seconds

◆ PRECAUTIONS FOR USERS

Soldering method

The capacitors of Alchip-series have no capability to withstand such dip or wave soldering as totally immerses components into a solder bath.

Reflow soldering

Reflow the capacitors within recommended reflow soldering conditions. Verify there is no temperature stress to the capacitors because the following differences might degrade capacitors electrically and mechanically. Please consult us if other reflow conditions are employed.

1. Location of components : Temperature increases at the edge of PC board more than the center.
2. Population of PC board : The lower the component population is, the more temperature rises.
3. Material of PC board : A ceramic made board needs more heat than a glass epoxy made board. The heat increase may cause damage to the capacitors.
4. Thickness of PC board : A thicker board needs more heat than a thinner board. The heat increase may damage the capacitors.
5. Size of PC board : A larger board needs more heat than a smaller board. The heat increase may damage the capacitors.
6. Solder thickness
If very thin cream solder paste is to be used for SMD types, please consult with us.
7. Location of infrared ray lamps : IR reflow as well as hot plate reflow heats only on the reverse side of the PC board to lessen heat stress to the capacitors.
8. Please consult us about vapor phase soldering (VPS).

Rework of soldering

Use a soldering iron for rework. Do not exceed an iron tip temperature of 380±10°C and an exposure time of 3±0.5 seconds.

Mechanical stress

Do not use the capacitors for lifting the PC board and give stress to the capacitor. Avoid bending the PC board. This may damage the capacitors.

Cleaning assembly board

Immediately after solvent cleaning, remove residual solvent with an air knife for at least 10 minutes. If the solvent is insufficiently dry, the capacitors may corrode.

Coating on assembly board

1. Before curing coating material, remove the cleaning solvents from the assembly board.
2. Before conformal coating, a chloride free pre-coat material is recommended to decrease the stress on the capacitors.

Molding with resin

Internal chemical reaction gradually produces gas in the capacitor; then, increasing internal pressure. If the end seal of the capacitor is completely covered by resin the gas will be unable to escape causing a potentially dangerous situation. The chlorine contained resin will penetrate into the end seal, reach the inside element, and cause damage of the capacitor.

Others

Refer to PRECAUTIONS AND GUIDELINES.



PART NUMBERING SYSTEM

Product code guide (Surface mount type)

(Example : MVA series, 25V-47 μ F, ϕ 6.3 \times 5.2L)

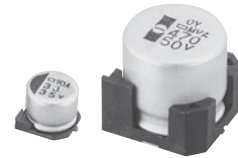

Please refer to the following table

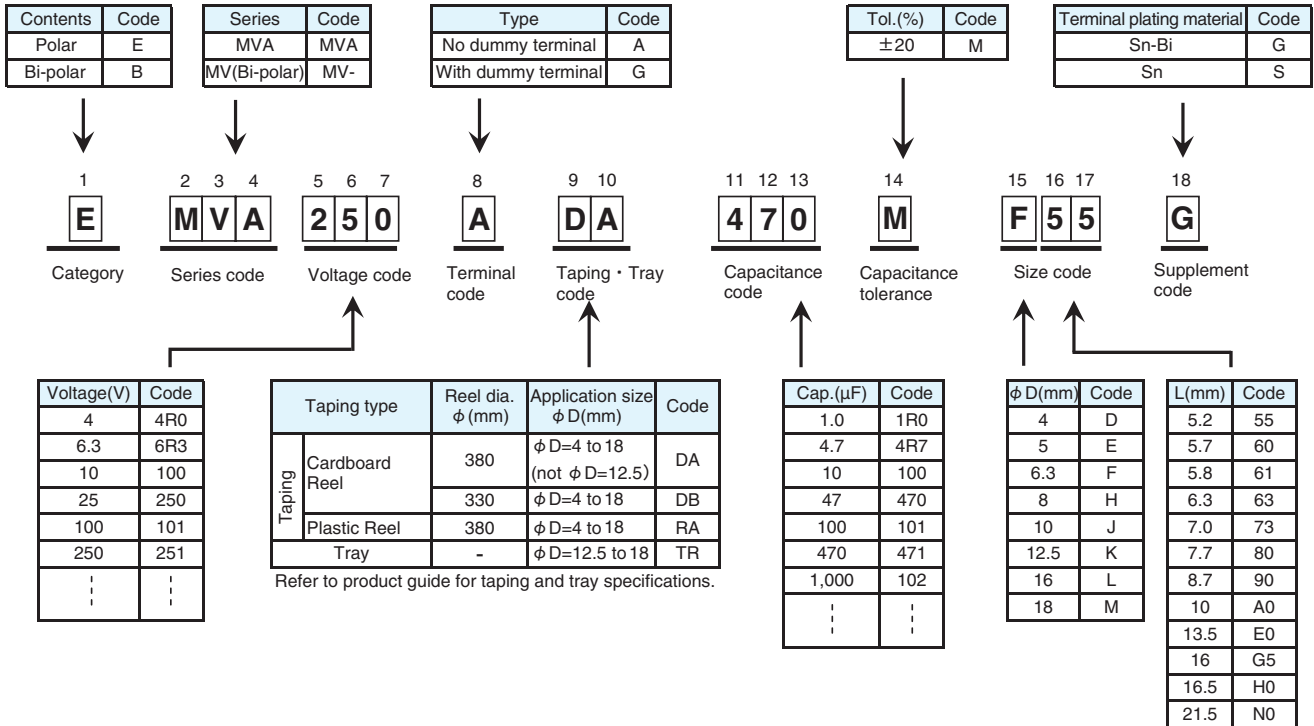

*Refer to the appendix (Part number) for codes not listed here.

Return Group Chart



SURFACE MOUNT ALUMINUM ELECTROLYTIC CAPACITORS

Standard, 85°C

Alchip™-MVA Series

- ϕ 4 through ϕ 18 case sizes are fully lined up
- Endurance : 2,000 hours at 85°C
- Suitable to fit for downsized equipment
- Solvent resistant type except 100 to 450V_{dc} (see PRECAUTIONS AND GUIDELINES)
- RoHS Compliant

MVA → MVE P94
105°C



◆ SPECIFICATIONS

Items	Characteristics												
Category	-40 to +85°C												
Temperature Range	-40 to +85°C												
Rated Voltage Range	4 to 450V _{dc}												
Capacitance Tolerance	±20% (M) (at 20°C, 120Hz)												
Leakage Current	Rated voltage (V _{dc})	4 to 100V						160 to 450V					
	D55 to JA0	I=0.01CV or 3μA, whichever is greater.(after 2 minutes)						—					
	KE0 to MN0	I=0.03CV or 4μA, whichever is greater.(after 1 minute)						I=0.04CV+100μA max.(after 1 minute)					
Where, I : Max. leakage current (μA), C : Nominal capacitance (μF), V : Rated voltage (V) (at 20°C)													
Dissipation Factor (tan δ)	Rated voltage (V _{dc})	4V	6.3V	10V	16V	25V	35V	50V	63V	100V	160 to 250V	400 & 450V	
	tan δ (Max.)	D55 to JA0	0.42	0.35	0.30	0.26	0.16	0.14	0.12	0.12	0.12	—	—
		KE0 to MN0	—	0.38	0.34	0.30	0.26	0.22	0.18	0.14	0.10	0.20	0.25
When nominal capacitance exceeds 1,000μF, add 0.02 to the value above for each 1,000μF increase. (at 20°C, 120Hz)													
Low Temperature Characteristics (Max. Impedance Ratio)	Rated voltage (V _{dc})	4V	6.3V	10V	16V	25V	35V	50V	63V	100V	160 to 250V	400 & 450V	
	D55 to JA0	Z(-25°C)/Z(+20°C)	7	4	3	2	2	2	2	2	3	—	—
		Z(-40°C)/Z(+20°C)	17	10	8	6	4	3	3	3	4	—	—
	KE0 to MN0	Z(-25°C)/Z(+20°C)	—	5	4	3	2	2	2	2	2	3	6
Z(-40°C)/Z(+20°C)		—	12	10	8	5	4	3	3	3	6	10	
(at 120Hz)													
Endurance	The following specifications shall be satisfied when the capacitors are restored to 20°C after the rated voltage is applied for 2,000 hours at 85°C.												
	Size code	D55 to JA0				D55 to JA0				KE0 to MN0			
	Rated voltage (V _{dc})	4V & 6.3V				10 to 100V				6.3 to 450V			
	Capacitance change	≤ ±30% of the initial value				≤ ±20% of the initial value				≤ ±20% of the initial value			
	D.F. (tan δ)	≤200% of the initial specified value				≤200% of the initial specified value				≤200% of the initial specified value			
	Leakage current	≤The initial specified value				≤The initial specified value				≤The initial specified value			
Shelf Life	The following specifications shall be satisfied when the capacitors are restored to 20°C after exposing them for 1,000 hours at 85°C without voltage applied. Before the measurement, the capacitor shall be preconditioned by applying voltage according to Item 4.1 of JIS C 5101-4.												
	Size code	D55 to JA0				D55 to JA0				KE0 to MN0			
	Rated voltage	4V & 6.3V				10 to 100V				6.3 to 450V			
	Capacitance change	≤ ±30% of the initial value				≤ ±20% of the initial value				≤ ±20% of the initial value			
	D.F. (tan δ)	≤200% of the initial specified value				≤200% of the initial specified value				≤200% of the initial specified value			
	Leakage current	≤The initial specified value				≤The initial specified value				≤The initial specified value			

◆ DIMENSIONS [mm]

- Terminal Code : A
- Size code : D55 to MN0

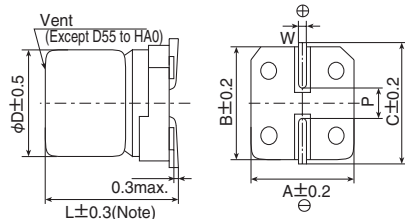

Note : L±0.5 for HA0 to MN0

- Terminal Code : G (Vibration resistant structure)
- Size code : LH0 to MN0

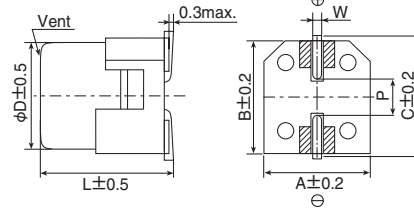

▨ : Dummy terminals

Size code	D	L	A	B	C	W	P
D55	4	5.2	4.3	4.3	5.1	0.5 to 0.8	1.0
E55	5	5.2	5.3	5.3	5.9	0.5 to 0.8	1.4
F55	6.3	5.2	6.6	6.6	7.2	0.5 to 0.8	1.9
F80	6.3	7.7	6.6	6.6	7.2	0.5 to 0.8	1.9
HA0	8	10.0	8.3	8.3	9.0	0.7 to 1.1	3.1
JA0	10	10.0	10.3	10.3	11.0	0.7 to 1.1	4.5
KE0	12.5	13.5	13.0	13.0	13.7	1.0 to 1.3	4.2
KG5	12.5	16.0	13.0	13.0	13.7	1.0 to 1.3	4.2
LH0	16	16.5	17.0	17.0	18.0	1.0 to 1.3	6.5
LN0	16	21.5	17.0	17.0	18.0	1.0 to 1.3	6.5
MH0	18	16.5	19.0	19.0	20.0	1.0 to 1.3	6.5
MN0	18	21.5	19.0	19.0	20.0	1.0 to 1.3	6.5

◆ MARKING

D55 to JA0
EX) 16V47μF



KE0 to HN0
EX) 25V1,000μF

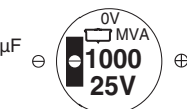

◆ PART NUMBERING SYSTEM

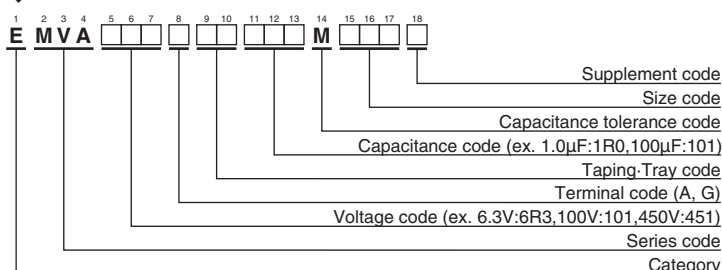

◆ RATED RIPPLE CURRENT MULTIPLIERS

- Frequency Multipliers

Size code	Capacitance(μF)	Frequency(Hz)			
		1.0	120	1k	10k
D55 to JA0	1.0	1.00	1.50	1.75	1.80
	2.2 to 10	1.00	1.30	1.40	1.50
	22 to 1,500	1.00	1.05	1.08	1.08
KE0 to MN0	4.7	1.00	1.75	2.30	2.50
	10 to 68	1.00	1.50	1.75	1.80
	100 to 1,000	1.00	1.30	1.40	1.50
	2,200 to 10,000	1.00	1.05	1.08	1.08

The endurance of capacitors is reduced with internal heating produced by ripple current at the rate of halving the lifetime with every 5°C rise.

When long life performance is required in actual use, the rms ripple current has to be reduced.

Please refer to "Product code guide (surface mount type)"

Return Group Chart



SURFACE MOUNT ALUMINUM ELECTROLYTIC CAPACITORS

Standard, 85°C

Alchip™-MVA Series

◆ STANDARD RATINGS

□ is not solvent resistant.

WV (V _{dc})	Cap (μF)	Size code	tan δ	Rated ripple current (mArms/85°C, 120Hz)	Part No.	WV (V _{dc})	Cap (μF)	Size code	tan δ	Rated ripple current (mArms/85°C, 120Hz)	Part No.	
4	33	D55	0.42	25	EMVA4R0ADA330MD55G	35	33	F55	0.14	54	EMVA350ADA330MF55G	
	47	D55	0.42	30	EMVA4R0ADA470MD55G		100	F80	0.14	120	EMVA350ADA101MF80G	
	100	E55	0.42	50	EMVA4R0ADA101ME55G		150	HA0	0.14	210	EMVA350ADA151MHA0G	
	220	F55	0.42	80	EMVA4R0ADA221MF55G		220	HA0	0.14	260	EMVA350ADA221MHA0G	
	330	F80	0.42	135	EMVA4R0ADA331MF80G		330	JA0	0.14	360	EMVA350ADA331MJA0G	
	470	F80	0.42	150	EMVA4R0ADA471MF80G		470	KE0	0.22	600	EMVA350ARA471MKE0S	
	1,000	HA0	0.42	320	EMVA4R0ADA102MHA0G		1,000	LH0	0.22	1,100	EMVA350□DA102MLH0S	
6.3	33	D55	0.35	30	EMVA6R3ADA330MD55G	50	2,200	MN0	0.24	1,700	EMVA350□DA222MMN0S	
	47	D55	0.35	33	EMVA6R3ADA470MD55G		3.3	D55	0.12	15	EMVA500ADA3R3MD55G	
	100	E55	0.35	55	EMVA6R3ADA101ME55G		4.7	D55	0.12	18	EMVA500ADA4R7MD55G	
	220	F55	0.35	88	EMVA6R3ADA221MF55G		10	E55	0.12	30	EMVA500ADA100ME55G	
	330	F80	0.35	135	EMVA6R3ADA331MF80G		22	F55	0.12	47	EMVA500ADA220MF55G	
	470	HA0	0.35	280	EMVA6R3ADA471MHA0G		33	F80	0.12	70	EMVA500ADA330MF80G	
	680	HA0	0.35	290	EMVA6R3ADA681MHA0G		47	F80	0.12	85	EMVA500ADA470MF80G	
	820	HA0	0.35	320	EMVA6R3ADA821MHA0G		100	HA0	0.12	190	EMVA500ADA101MHA0G	
	1,000	JA0	0.35	430	EMVA6R3ADA102MJA0G		220	JA0	0.12	320	EMVA500ADA221MJA0G	
	1,500	JA0	0.35	480	EMVA6R3ADA152MJA0G		330	KE0	0.18	600	EMVA500ARA331MKE0S	
	2,200	KE0	0.40	890	EMVA6R3ARA222MKE0S		470	KG5	0.18	740	EMVA500ARA471MKG5S	
	3,300	KG5	0.42	1,000	EMVA6R3ARA332MKG5S		470	LH0	0.18	850	EMVA500□DA471MLH0S	
	3,300	LH0	0.42	1,200	EMVA6R3□DA332MLH0S		1,000	LN0	0.18	1,300	EMVA500□DA102MLN0S	
	4,700	LH0	0.44	1,400	EMVA6R3□DA472MLH0S		1,000	MN0	0.18	1,400	EMVA500□DA102MMN0S	
	6,800	LN0	0.48	1,750	EMVA6R3□DA682MLN0S		63	1.0	D55	0.12	8.0	EMVA630ADA1R0MD55G
6,800	MH0	0.48	1,700	EMVA6R3□DA682MMH0S	2.2	D55		0.12	12	EMVA630ADA2R2MD55G		
10,000	MN0	0.56	2,000	EMVA6R3□DA103MMN0S	3.3	E55		0.12	17	EMVA630ADA3R3ME55G		
10	22	D55	0.30	26	EMVA100ADA220MD55G	4.7		E55	0.12	20	EMVA630ADA4R7ME55G	
	33	D55	0.30	30	EMVA100ADA330MD55G	10		F55	0.12	32	EMVA630ADA100MF55G	
	47	E55	0.30	44	EMVA100ADA470ME55G	22		F80	0.12	60	EMVA630ADA220MF80G	
	100	F55	0.30	70	EMVA100ADA101MF55G	33		HA0	0.12	110	EMVA630ADA330MHA0G	
	150	F55	0.30	79	EMVA100ADA151MF55G	47		HA0	0.12	130	EMVA630ADA470MHA0G	
	220	F80	0.30	130	EMVA100ADA221MF80G	56		JA0	0.12	160	EMVA630ADA560MJA0G	
	330	HA0	0.30	270	EMVA100ADA331MHA0G	68		JA0	0.12	170	EMVA630ADA680MJA0G	
	470	HA0	0.30	280	EMVA100ADA471MHA0G	100		KE0	0.14	380	EMVA630ARA101MKE0S	
	1,000	JA0	0.30	430	EMVA100ADA102MJA0G	220		KE0	0.14	580	EMVA630ARA221MKE0S	
	2,200	KE0	0.36	960	EMVA100ARA222MKE0S	330		KG5	0.14	720	EMVA630ARA331MKG5S	
	3,300	LH0	0.38	1,300	EMVA100□DA332MLH0S	330		LH0	0.14	820	EMVA630□DA331MLH0S	
	4,700	LN0	0.40	1,550	EMVA100□DA472MLN0S	470		LH0	0.14	950	EMVA630□DA471MLH0S	
	4,700	MH0	0.40	1,600	EMVA100□DA472MMH0S	470	MH0	0.14	1,000	EMVA630□DA471MMH0S		
	6,800	MN0	0.44	1,850	EMVA100□DA682MMN0S	100	22	HA0	0.12	90	EMVA101ADA220MHA0G	
	16	22	D55	0.26	26		EMVA160ADA220MD55G	33	JA0	0.12	120	EMVA101ADA330MJA0G
33		E55	0.26	37	EMVA160ADA330ME55G		68	KE0	0.10	380	EMVA101ARA680MKE0S	
47		E55	0.26	44	EMVA160ADA470ME55G		100	KE0	0.10	440	EMVA101ARA101MKE0S	
100		F55	0.26	70	EMVA160ADA101MF55G		220	LN0	0.10	850	EMVA101□DA221MLN0S	
150		F80	0.26	110	EMVA160ADA151MF80G		220	MH0	0.10	800	EMVA101□DA221MMH0S	
220		F80	0.26	130	EMVA160ADA221MF80G		330	MN0	0.10	1,000	EMVA101□DA331MMN0S	
330		HA0	0.26	270	EMVA160ADA331MHA0G		47	KG5	0.20	370	EMVA161ARA470MKG5S	
470		HA0	0.26	280	EMVA160ADA471MHA0G		68	LH0	0.20	500	EMVA161□DA680MLH0S	
680		JA0	0.26	380	EMVA160ADA681MJA0G		100	LN0	0.20	590	EMVA161□DA101MLN0S	
1,000		KE0	0.30	710	EMVA160ARA102MKE0S		100	MH0	0.20	590	EMVA161□DA101MMH0S	
2,200		LH0	0.32	1,150	EMVA160□DA222MLH0S		200	22	KE0	0.20	240	EMVA201ARA220MKE0S
3,300		LN0	0.34	1,450	EMVA160□DA332MLN0S			33	KG5	0.20	310	EMVA201ARA330MKG5S
3,300		MH0	0.34	1,450	EMVA160□DA332MMH0S			47	LH0	0.20	420	EMVA201□DA470MLH0S
4,700		MN0	0.36	1,750	EMVA160□DA472MMN0S			68	LN0	0.20	510	EMVA201□DA680MLN0S
25		10	D55	0.16	24	EMVA250ADA100MD55G		68	MH0	0.20	510	EMVA201□DA680MMH0S
	22	E55	0.16	41	EMVA250ADA220ME55G	100		MN0	0.20	590	EMVA201□DA101MMN0S	
	33	E55	0.16	47	EMVA250ADA330ME55G	250	10	KE0	0.20	150	EMVA251ARA100MKE0S	
	47	F55	0.16	60	EMVA250ADA470MF55G		22	KG5	0.20	240	EMVA251ARA220MKG5S	
	56	F55	0.16	66	EMVA250ADA560MF55G		33	LH0	0.20	340	EMVA251□DA330MLH0S	
	100	F80	0.16	120	EMVA250ADA101MF80G		47	LN0	0.20	420	EMVA251□DA470MLN0S	
	150	HA0	0.16	210	EMVA250ADA151MHA0G		47	MH0	0.20	420	EMVA251□DA470MMH0S	
	220	HA0	0.16	260	EMVA250ADA221MHA0G		68	MN0	0.20	490	EMVA251□DA680MMN0S	
	330	HA0	0.16	300	EMVA250ADA331MHA0G	400	4.7	KE0	0.25	120	EMVA401ARA4R7MKE0S	
	470	JA0	0.16	400	EMVA250ADA471MJA0G		10	LH0	0.25	140	EMVA401□DA100MLH0S	
	1,000	KE0	0.26	820	EMVA250ARA102MKE0S		22	LN0	0.25	280	EMVA401□DA220MLN0S	
	2,200	LN0	0.28	1,450	EMVA250□DA222MLN0S		22	MH0	0.25	280	EMVA401□DA220MMH0S	
	2,200	MH0	0.28	1,400	EMVA250□DA222MMH0S		33	MN0	0.25	350	EMVA401□DA330MMN0S	
	3,300	MN0	0.30	1,800	EMVA250□DA332MMN0S		450	4.7	KE0	0.25	120	EMVA451ARA4R7MKE0S
	35	4.7	D55	0.14	18	EMVA350ADA4R7MD55G		10	LH0	0.25	140	EMVA451□DA100MLH0S
10		D55	0.14	24	EMVA350ADA100MD55G	22		LN0	0.25	280	EMVA451□DA220MLN0S	
22		E55	0.14	41	EMVA350ADA220ME55G	33		MN0	0.25	350	EMVA451□DA330MMN0S	

□ : Enter the appropriate terminal code.

Return Group Chart



SURFACE MOUNT ALUMINUM ELECTROLYTIC CAPACITORS

Standard, 105°C

Alchip™-MVE Series

- Endurance : 1,000 to 2,000 hours at 105°C
- Case size range : $\phi 4 \times 5.2L$ to $\phi 18 \times 21.5L$
- Solvent resistant type except 100 to 450V_{dc} (see PRECAUTIONS AND GUIDELINES)
- RoHS Compliant
- AEC-Q200 compliant : Please contact Chemi-Con for more details, test data, information.

MVE → Longer life → MVL P117
MVJ P119



◆ SPECIFICATIONS

Items	Characteristics												
Category Temperature Range	-40 to +105°C												
Rated Voltage Range	6.3 to 450V _{dc}												
Capacitance Tolerance	±20%(M) (at 20°C, 120Hz)												
Leakage Current	Rated voltage (V _{dc})	6.3 to 100V						160 to 450V					
	D55 to JA0	I=0.01CV or 3μA, whichever is greater (2 minutes)						—					
	KE0 to MN0	I=0.03CV or 4μA, whichever is greater (1 minute)						I=0.04CV+100μA (1 minute)					
	Where, I : Max. leakage current (μA), C : Nominal capacitance (μF), V : Rated voltage (V) (at 20°C)												
Dissipation Factor (tan δ)	See STANDARD RATINGS (at 20°C, 120Hz)												
Low Temperature Characteristics (Max. Impedance Ratio)	Rated voltage (V _{dc})	6.3V	10V	16V	25V	35V	50V	63V	100V	160 to 250V	400 to 450V		
	D55 to JA0	Z(-25°C)/Z(+20°C)	4	3	2	2	2	2	2	3	—	—	
		Z(-40°C)/Z(+20°C)	12	8	6	4	3	3	3	4	—	—	
	KE0 to MN0	Z(-25°C)/Z(+20°C)	5	4	3	2	2	2	2	2	3	6	
Z(-40°C)/Z(+20°C)		10	8	6	4	3	3	3	3	6	10		
Endurance	The following specifications shall be satisfied when the capacitors are restored to 20°C after the rated voltage is applied for the specified period of time at 105°C.												
	Size code	D55 to F80					HA0 to MN0						
	Time	1,000 hours					2,000 hours						
	Capacitance change	≤ ±30% of the initial value					≤ ±20% of the initial value						
	D.F. (tan δ)	≤300% of the initial specified value					≤200% of the initial specified value						
	Leakage current	≤The initial specified value					≤The initial specified value						
Shelf Life	The following specifications shall be satisfied when the capacitors are restored to 20°C after exposing them for 1,000 hours (500 hours for B55 to F80 size) at 105°C without voltage applied. Before the measurement, the capacitor shall be preconditioned by applying voltage according to Item 4.1 of JIS C 5101-4.												
	Size code	D55 to F80					HA0 to MN0						
	Capacitance change	≤ ±25% of the initial value					≤ ±20% of the initial value						
	D.F. (tan δ)	≤200% of the initial specified value					≤200% of the initial specified value						
	Leakage current	≤The initial specified value					≤The initial specified value						

◆ DIMENSIONS [mm]

● Terminal Code : A

● Size code : D55 to MN0

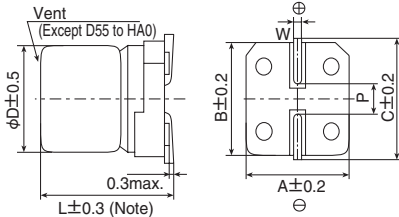

Note : L±0.5 for HA0 to MN0

● Terminal Code : G (Vibration resistant structure)

● Size code : LH0 to MN0

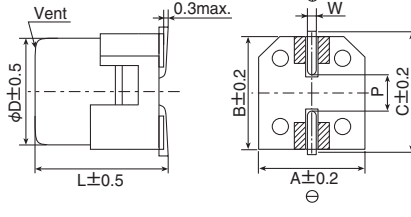

▨ : Dummy terminals

Size code	D	L	A	B	C	W	P
D55	4	5.2	4.3	4.3	5.1	0.5 to 0.8	1.0
E55	5	5.2	5.3	5.3	5.9	0.5 to 0.8	1.4
F55	6.3	5.2	6.6	6.6	7.2	0.5 to 0.8	1.9
F80	6.3	7.7	6.6	6.6	7.2	0.5 to 0.8	1.9
HA0	8	10.0	8.3	8.3	9.0	0.7 to 1.1	3.1
JA0	10	10.0	10.3	10.3	11.0	0.7 to 1.1	4.5
KE0	12.5	13.5	13.0	13.0	13.7	1.0 to 1.3	4.2
KG5	12.5	16.0	13.0	13.0	13.7	1.0 to 1.3	4.2
LH0	16	16.5	17.0	17.0	18.0	1.0 to 1.3	6.5
LN0	16	21.5	17.0	17.0	18.0	1.0 to 1.3	6.5
MH0	18	16.5	19.0	19.0	20.0	1.0 to 1.3	6.5
MN0	18	21.5	19.0	19.0	20.0	1.0 to 1.3	6.5

◆ MARKING

D55 to JA0

Ex) 16V22μF

KE0 to MN0

Ex) 25V1,000μF

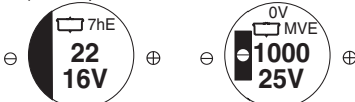

◆ PART NUMBERING SYSTEM

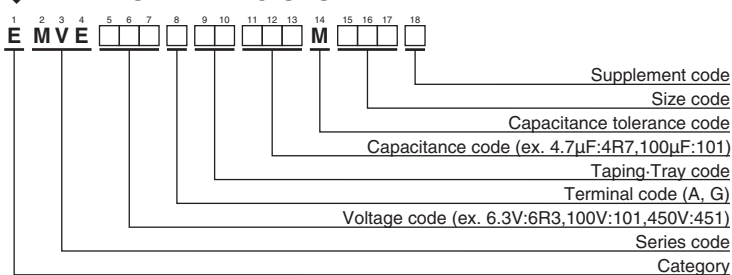

◆ RATED RIPPLE CURRENT MULTIPLIERS

● Frequency Multipliers

Size code	Capacitance(μF)	Frequency(Hz)			
		120	1k	10k	100k
D55 to JA0	1.0	1.00	1.50	1.75	1.80
	2.2 to 10	1.00	1.30	1.40	1.50
	22 to 1,500	1.00	1.05	1.08	1.08
KE0 to MN0	3.3 to 4.7	1.00	1.75	2.30	2.50
	10 to 68	1.00	1.50	1.75	1.80
	100 to 1,000	1.00	1.30	1.40	1.50
	2,200 to 6,800	1.00	1.05	1.08	1.08

The endurance of capacitors is reduced with internal heating produced by ripple current at the rate of halving the lifetime with every 5°C rise.

When long life performance is required in actual use, the rms ripple current has to be reduced.

Please refer to "Product code guide (surface mount type)"

Return Group Chart



SURFACE MOUNT ALUMINUM ELECTROLYTIC CAPACITORS

Standard, 105°C

Alchip™-MVE Series

◆STANDARD RATINGS

is not solvent resistant.

WV (V _{dc})	Cap (μF)	Size code	tan δ	Rated ripple current (mA _{rms} /105°C, 120Hz)	Part No.	WV (V _{dc})	Cap (μF)	Size code	tan δ	Rated ripple current (mA _{rms} /105°C, 120Hz)	Part No.	
6.3	22	D55	0.30	22	EMVE6R3ADA220MD55G	35	330	JA0	0.16	450	EMVE350ADA331MJA0G	
	33	E55	0.30	34	EMVE6R3ADA330ME55G		470	KE0	0.22	520	EMVE350ARA471MKE0S	
	47	E55	0.30	38	EMVE6R3ADA470ME55G		470	LH0	0.22	650	EMVE350□DA471MLH0S	
	100	F55	0.30	69	EMVE6R3ADA101MF55G		1,000	LH0	0.22	750	EMVE350□DA102MLH0S	
	220	F80	0.45	120	EMVE6R3ADA221MF80G		1,000	MH0	0.22	1,000	EMVE350□DA102MMH0S	
	330	HA0	0.40	290	EMVE6R3ADA331MHA0G		2,200	MN0	0.24	1,450	EMVE350□DA222MMN0S	
	470	HA0	0.45	320	EMVE6R3ADA471MHA0G		50	1.0	D55	0.12	8.0	EMVE500ADA1R0MD55G
	680	HA0	0.45	340	EMVE6R3ADA681MHA0G			2.2	D55	0.12	12	EMVE500ADA2R2MD55G
	1,000	JA0	0.40	410	EMVE6R3ADA102MJA0G			3.3	D55	0.12	15	EMVE500ADA3R3MD55G
	1,500	JA0	0.45	550	EMVE6R3ADA152MJA0G			4.7	E55	0.12	20	EMVE500ADA4R7ME55G
	2,200	KE0	0.40	680	EMVE6R3ARA222MKE0S			10	F55	0.12	32	EMVE500ADA100MF55G
	2,200	LH0	0.40	840	EMVE6R3□DA222MLH0S			33	F80	0.14	65	EMVE500ADA330MF80G
	3,300	KG5	0.42	850	EMVE6R3ARA332MKG5S			47	F80	0.14	80	EMVE500ADA470MF80G
	3,300	MH0	0.42	1,000	EMVE6R3□DA332MMH0S			100	HA0	0.14	230	EMVE500ADA101MHA0G
4,700	LN0	0.44	1,200	EMVE6R3□DA472MLN0S	220	JA0		0.14	375	EMVE500ADA221MJA0G		
4,700	MH0	0.44	1,200	EMVE6R3□DA472MMH0S	330	KE0		0.18	500	EMVE500ARA331MKE0S		
6,800	LN0	0.48	1,200	EMVE6R3□DA682MLN0S	330	LH0		0.18	600	EMVE500□DA331MLH0S		
6,800	MN0	0.48	1,350	EMVE6R3□DA682MMN0S	470	LH0		0.18	700	EMVE500□DA471MLH0S		
470	MH0	0.18	750	EMVE500□DA471MMH0S	470	MH0		0.18	750	EMVE500□DA471MMH0S		
1,000	MN0	0.18	1,200	EMVE500□DA102MMN0S	1,000	MN0		0.18	1,200	EMVE500□DA102MMN0S		
10	22	E55	0.24	30	EMVE100ADA220ME55G	63	1.0	D55	0.12	8.0	EMVE630ADA1R0MD55G	
	33	E55	0.24	34	EMVE100ADA330ME55G		2.2	D55	0.12	12	EMVE630ADA2R2MD55G	
	47	F55	0.24	48	EMVE100ADA470MF55G		3.3	E55	0.12	17	EMVE630ADA3R3ME55G	
	100	F55	0.30	69	EMVE100ADA101MF55G		4.7	F55	0.12	22	EMVE630ADA4R7MF55G	
	150	F80	0.35	100	EMVE100ADA151MF80G		10	F55	0.12	32	EMVE630ADA100MF55G	
	220	F80	0.35	120	EMVE100ADA221MF80G		22	F80	0.12	58	EMVE630ADA220MF80G	
	330	HA0	0.35	290	EMVE100ADA331MHA0G		33	HA0	0.12	140	EMVE630ADA330MHA0G	
	470	HA0	0.35	320	EMVE100ADA471MHA0G		47	HA0	0.12	170	EMVE630ADA470MHA0G	
	1,000	JA0	0.35	410	EMVE100ADA102MJA0G		100	JA0	0.12	310	EMVE630ADA101MJA0G	
	2,200	KG5	0.36	750	EMVE100ARA222MKG5S		220	KE0	0.14	470	EMVE630ARA221MKE0S	
	2,200	LH0	0.36	850	EMVE100□DA222MLH0S		220	LH0	0.14	560	EMVE630□DA221MLH0S	
	3,300	LH0	0.38	1,000	EMVE100□DA332MLH0S		330	LH0	0.14	700	EMVE630□DA331MLH0S	
	3,300	MH0	0.38	1,100	EMVE100□DA332MMH0S		330	MH0	0.14	750	EMVE630□DA331MMH0S	
	4,700	LN0	0.40	1,300	EMVE100□DA472MLN0S		470	LN0	0.14	900	EMVE630□DA471MLN0S	
4,700	MN0	0.40	1,350	EMVE100□DA472MMN0S	470	MH0	0.14	900	EMVE630□DA471MMH0S			
16	10	D55	0.20	17	EMVE160ADA100MD55G	100	22	HA0	0.12	100	EMVE101ADA220MHA0G	
	22	E55	0.20	30	EMVE160ADA220ME55G		33	JA0	0.12	150	EMVE101ADA330MJA0G	
	33	F55	0.20	45	EMVE160ADA330MF55G		47	KE0	0.10	250	EMVE101ARA470MKE0S	
	47	F55	0.20	48	EMVE160ADA470MF55G		68	KE0	0.10	300	EMVE101ARA680MKE0S	
	100	F55	0.26	69	EMVE160ADA101MF55G		100	KE0	0.10	380	EMVE101ARA101MKE0S	
	150	F80	0.28	100	EMVE160ADA151MF80G		100	LH0	0.10	450	EMVE101□DA101MLH0S	
	220	F80	0.28	120	EMVE160ADA221MF80G		220	LN0	0.10	750	EMVE101□DA221MLN0S	
	330	HA0	0.28	290	EMVE160ADA331MHA0G		220	MH0	0.10	750	EMVE101□DA221MMH0S	
	470	HA0	0.28	320	EMVE160ADA471MHA0G		330	MN0	0.10	980	EMVE101□DA331MMN0S	
	680	JA0	0.28	470	EMVE160ADA681MJA0G		33	KE0	0.15	95	EMVE161ARA330MKE0S	
	1,000	KE0	0.30	550	EMVE160ARA102MKE0S		47	LH0	0.15	260	EMVE161□DA470MLH0S	
	1,000	LH0	0.30	650	EMVE160□DA102MLH0S		68	LN0	0.15	320	EMVE161□DA680MLN0S	
	2,200	LH0	0.32	950	EMVE160□DA222MLH0S		68	MH0	0.15	320	EMVE161□DA680MMH0S	
	2,200	MH0	0.32	1,000	EMVE160□DA222MMH0S		100	LN0	0.15	380	EMVE161□DA101MLN0S	
3,300	LN0	0.34	1,200	EMVE160□DA332MLN0S	200	10	KE0	0.15	80	EMVE201ARA100MKE0S		
3,300	MH0	0.34	1,200	EMVE160□DA332MMH0S		22	KG5	0.15	110	EMVE201ARA220MKG5S		
10	E55	0.16	27	EMVE250ADA100ME55G		33	LH0	0.15	220	EMVE201□DA330MLH0S		
22	F55	0.16	44	EMVE250ADA220MF55G		47	LN0	0.15	270	EMVE201□DA470MLN0S		
33	F55	0.16	50	EMVE250ADA330MF55G		47	MH0	0.15	270	EMVE201□DA470MMH0S		
47	F55	0.16	60	EMVE250ADA470MF55G		68	MN0	0.15	330	EMVE201□DA680MMN0S		
100	F80	0.18	100	EMVE250ADA101MF80G		4.7	KE0	0.15	65	EMVE251ARA47R7MKE0S		
150	HA0	0.18	240	EMVE250ADA151MHA0G		10	KG5	0.15	105	EMVE251ARA100MKG5S		
220	HA0	0.18	320	EMVE250ADA221MHA0G		22	LH0	0.15	180	EMVE251□DA220MLH0S		
330	JA0	0.16	450	EMVE250ADA331MJA0G		33	LN0	0.15	230	EMVE251□DA330MLN0S		
470	JA0	0.18	490	EMVE250ADA471MJA0G		33	MH0	0.15	230	EMVE251□DA330MMH0S		
1,000	LH0	0.26	820	EMVE250□DA102MLH0S		47	MN0	0.15	280	EMVE251□DA470MMN0S		
1,000	MH0	0.26	880	EMVE250□DA102MMH0S		4.7	KG5	0.20	50	EMVE401ARA47R7MKG5S		
2,200	LN0	0.28	1,250	EMVE250□DA222MLN0S		10	LH0	0.20	85	EMVE401□DA100MLH0S		
2,200	MN0	0.28	1,300	EMVE250□DA222MMN0S	22	MN0	0.20	130	EMVE401□DA220MMN0S			
35	4.7	D55	0.14	16	EMVE350ADA4R7MD55G	400	3.3	KE0	0.20	40	EMVE451ARA3R3MKE0S	
	10	E55	0.14	27	EMVE350ADA100ME55G		4.7	KG5	0.20	50	EMVE451ARA47R7MKG5S	
	22	F55	0.14	44	EMVE350ADA220MF55G		10	LH0	0.20	85	EMVE451□DA100MLH0S	
	47	F80	0.16	80	EMVE350ADA470MF80G		22	MN0	0.20	130	EMVE451□DA220MMN0S	
	100	F80	0.16	100	EMVE350ADA101MF80G		450	10	LH0	0.20	85	EMVE451□DA100MLH0S
	150	HA0	0.16	260	EMVE350ADA151MHA0G			22	MN0	0.20	130	EMVE451□DA220MMN0S
220	JA0	0.16	375	EMVE350ADA221MJA0G								

: Enter the appropriate terminal code.

Return Group Chart



SURFACE MOUNT ALUMINUM ELECTROLYTIC CAPACITORS

Low ESR, 105°C

Alchip™-MZR Series

- Downsizing and Lower ESR, 2,000hours at 105°C
- Rated voltage range : 6.3 to 50V, Nominal capacitance range : 100 to 2,200μF
- Solvent resistant type
- Vibration resistance structure
- RoHS Compliant
- AEC-Q200 compliant : Please contact Chemi-Con for more details, test data, information.

MZR

↑
Downsized
MZJ P98



◆ SPECIFICATIONS

Items	Characteristics
Category	-55 to +105°C
Temperature Range	-55 to +105°C
Rated Voltage Range	6.3 to 50V _{dc}
Capacitance Tolerance	±20% (M) (at 20°C, 120Hz)
Leakage Current	I=0.01CV or 3μA, whichever is greater. Where, I : Max. leakage current (μA), C : Nominal capacitance (μF), V : Rated voltage (V) (at 20°C after 2 minutes)
Dissipation Factor (tan δ)	Rated voltage (V _{dc})
	tan δ (Max.)
Low Temperature Characteristics (Max. Impedance Ratio)	Rated voltage (V _{dc})
	Z(-25°C)/Z(+20°C)
	Z(-40°C)/Z(+20°C)
	Z(-55°C)/Z(+20°C)
Endurance	The following specifications shall be satisfied when the capacitors are restored to 20°C after the rated voltage is applied for 2,000 hours at 105°C.
	Capacitance change
	D.F. (tan δ)
	Leakage current
Shelf Life	The following specifications shall be satisfied when the capacitors are restored to 20°C after exposing them for 1,000 hours at 105°C without voltage applied. Before the measurement, the capacitor shall be preconditioned by applying voltage according to Item 4.1 of JIS C 5101-4.
	Capacitance change
	D.F. (tan δ)
	Leakage current
Surge Voltage Test	The capacitors shall be subjected to 1,000 cycles each consisting of charging with the specified surge voltage for 30±5 seconds through a protective resistor (as required for RC=0.1±0.05sec) and open-circuiting for 5.5 minutes at a room temperature of 15 to 35°C.
	Rated voltage (V _{dc})
	Surge voltage (V _{dc})
	Appearance
	Capacitance change
	D.F. (tan δ)
	Leakage current
	(Caution)
	Surge Voltage Test intends to evaluate capacitors in durability of an exceptional excessive voltage under specific conditions. It does not imply long-term use at all.

◆ DIMENSIONS [mm]

- Terminal Code : A
- Size code : F80 to JA0

- Terminal Code : G (Vibration resistant structure)
- Size code : HA0 and JA0

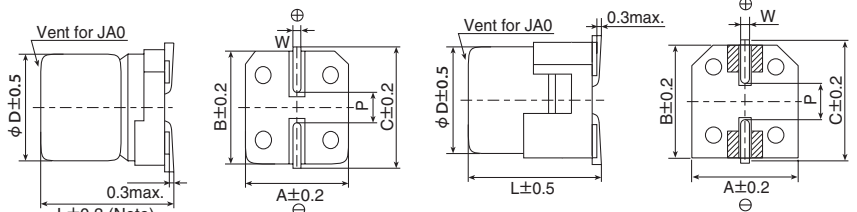

Note : L±0.5 for HA0 and JA0

▨ : Dummy terminals

Size code	D	L	A	B	C	W	P
F80	6.3	7.7	6.6	6.6	7.2	0.5 to 0.8	1.9
HA0	8	10.0	8.3	8.3	9.0	0.7 to 1.1	3.1
JA0	10	10.0	10.3	10.3	11.0	0.7 to 1.1	4.5

◆ MARKING

EX) 35V330μF



- Rated voltage symbol

Rated voltage (V _{dc})	6.3	10	16	25	35	50
Symbol	j	A	C	E	V	H

Applying voltage over the rated voltages causes the capacitors to have short lifetime. Besides, applying voltage over the specified surge voltages may cause to have short circuit failure. A protection circuit should be used if applied voltage will exceed the rated voltages.

Alchip™-MZR Series

◆PART NUMBERING SYSTEM

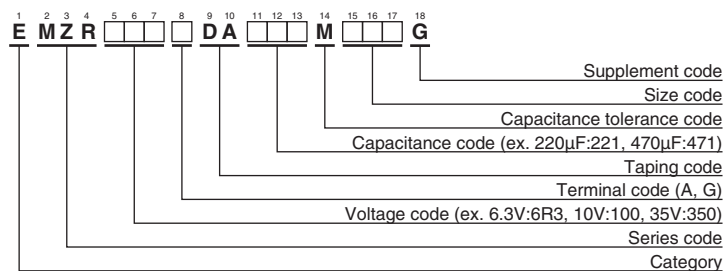

◆STANDARD RATINGS

WV (V _{dc})	Cap (μF)	Size code	tan δ	ESR (Ω max./20°C, 100kHz)	Rated ripple current (mA rms/105°C, 100kHz)	Part No.
6.3	680	F80	0.26	0.16	600	EMZR6R3ADA681MF80G
	1,500	HA0	0.26	0.08	850	EMZR6R3□DA152MHA0G
	2,200	JA0	0.26	0.06	1,190	EMZR6R3□DA222MJA0G
10	470	F80	0.19	0.16	600	EMZR100ADA471MF80G
	1,000	HA0	0.19	0.08	850	EMZR100□DA102MHA0G
	1,500	JA0	0.19	0.06	1,190	EMZR100□DA152MJA0G
16	330	F80	0.16	0.16	600	EMZR160ADA331MF80G
	680	HA0	0.16	0.08	850	EMZR160□DA681MHA0G
	1,000	JA0	0.16	0.06	1,190	EMZR160□DA102MJA0G
25	220	F80	0.14	0.16	600	EMZR250ADA221MF80G
	470	HA0	0.14	0.08	850	EMZR250□DA471MHA0G
	820	JA0	0.14	0.06	1,190	EMZR250□DA821MJA0G
35	150	F80	0.12	0.16	600	EMZR350ADA151MF80G
	330	HA0	0.12	0.08	850	EMZR350□DA331MHA0G
	560	JA0	0.12	0.06	1,190	EMZR350□DA561MJA0G
50	100	F80	0.10	0.34	350	EMZR500ADA101MF80G
	220	HA0	0.10	0.18	670	EMZR500□DA221MHA0G
	330	JA0	0.10	0.12	900	EMZR500□DA331MJA0G

□ : Enter the appropriate terminal code.

◆RATED RIPPLE CURRENT MULTIPLIERS

● Frequency Multipliers

Capacitance(μF)	Frequency(Hz)			
	120	1k	10k	100k
100 to 150	0.40	0.75	0.90	1.00
220 to 560	0.50	0.85	0.94	1.00
680 to 2,200	0.60	0.87	0.95	1.00

The endurance of capacitors is reduced with internal heating produced by ripple current at the rate of halving the lifetime with every 5°C rise. When long life performance is required in actual use, the rms ripple current has to be reduced.

Return Group Chart



SURFACE MOUNT ALUMINUM ELECTROLYTIC CAPACITORS

Low ESR, 105°C

Alchip™-MZJ Series

- Lower ESR, 2,000 hours at 105°C
- Rated voltage range : 6.3 to 35V
- Nominal capacitance range : 10 to 1,800μF
- Solvent resistant type (see PRECAUTIONS AND GUIDELINES)
- Vibration resistant structure
- RoHS Compliant
- AEC-Q200 compliant : Please contact Chemi-Con for more details, test data, information.

MZJ

↑ Lower ESR
MZA P100



◆ SPECIFICATIONS

Items	Characteristics					
Category	-55 to +105°C					
Temperature Range	-55 to +105°C					
Rated Voltage Range	6.3 to 35V _{dc}					
Capacitance Tolerance	±20% (M) (at 20°C, 120Hz)					
Leakage Current	I=0.01CV or 3μA, whichever is greater. Where, I : Max. leakage current (μA), C : Nominal capacitance (μF), V : Rated voltage (V) (at 20°C after 2 minutes)					
Dissipation Factor (tan δ)	Rated voltage (V _{dc})	6.3V	10V	16V	25V	35V
	tan δ (Max.)	0.26	0.19	0.16	0.14	0.12
Low Temperature Characteristics (Max. Impedance Ratio)	Rated voltage (V _{dc})	6.3V	10V	16V	25V	35V
	Z(-25°C)/Z(+20°C)	2	2	2	2	2
	Z(-40°C)/Z(+20°C)	3	3	3	3	3
	Z(-55°C)/Z(+20°C)	4	4	4	3	3
Endurance	The following specifications shall be satisfied when the capacitors are restored to 20°C after the rated voltage is applied for 2,000 hours at 105°C.					
	Capacitance change	≤ ±30% of the initial value				
	D.F. (tan δ)	≤200% of the initial specified value				
	Leakage current	≤The initial specified value				
Shelf Life	The following specifications shall be satisfied when the capacitors are restored to 20°C after exposing them for 1,000 hours at 105°C without voltage applied. Before the measurement, the capacitor shall be preconditioned by applying voltage according to Item 4.1 of JIS C 5101-4.					
	Capacitance change	≤ ±30% of the initial value				
	D.F. (tan δ)	≤200% of the initial specified value				
	Leakage current	≤The initial specified value				
Surge Voltage Test	The capacitors shall be subjected to 1,000 cycles each consisting of charging with the specified surge voltage for 30±5 seconds through a protective resistor (as required for RC=0.1±0.05sec) and open-circuiting for 5.5 minutes at a room temperature of 15 to 35°C.					
	Rated voltage (V _{dc})	6.3V	10V	16V	25V	35V
	Surge voltage (V _{dc})	7.2V	12V	18V	29V	40V
	Appearance	No significant damage				
	Capacitance change	≤ ±20% of the initial value				
	D.F. (tan δ)	≤200% of the initial specified value				
	Leakage current	≤The initial specified value				
	(Caution)	Surge Voltage Test intends to evaluate capacitors in durability of an exceptional excessive voltage under specific conditions. It does not imply long-term use at all.				

◆ DIMENSIONS [mm]

- Terminal Code : A
- Size code : D61 to JA0

- Terminal Code : G (Vibration resistant structure)
- Size code : HA0 and JA0

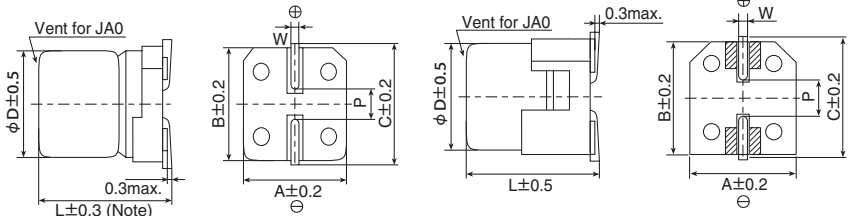

Note : L±0.5 for HA0 and JA0

▨ : Dummy terminals

Size code	D	L	A	B	C	W	P
D61	4	5.8	4.3	4.3	5.1	0.5 to 0.8	1.0
E61	5	5.8	5.3	5.3	5.9	0.5 to 0.8	1.4
F61	6.3	5.8	6.6	6.6	7.2	0.5 to 0.8	1.9
F80	6.3	7.7	6.6	6.6	7.2	0.5 to 0.8	1.9
HA0	8	10.0	8.3	8.3	9.0	0.7 to 1.1	3.1
JA0	10	10.0	10.3	10.3	11.0	0.7 to 1.1	4.5

◆ MARKING

EX) 35V10μF



- Rated voltage symbol

Rated voltage (V _{dc})	6.3	10	16	25	35
Symbol	j	A	C	E	V

Applying voltage over the rated voltages causes the capacitors to have short lifetime. Besides, applying voltage over the specified surge voltages may cause to have short circuit failure. A protection circuit should be used if applied voltage will exceed the rated voltages.

Return Group Chart



SURFACE MOUNT ALUMINUM ELECTROLYTIC CAPACITORS

Low ESR, 105°C

Alchip™-MZJ Series

◆PART NUMBERING SYSTEM

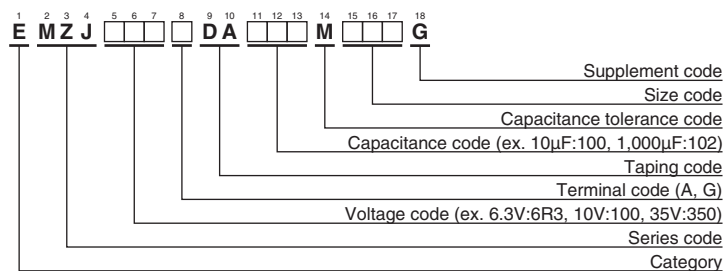

Please refer to "Product code guide (surface mount type)"

◆STANDARD RATINGS

WV (V _{dc})	Cap (µF)	Size code	tan δ	ESR (Ω max./20°C, 100kHz)	Rated ripple current (mA _{rms} /105°C, 100kHz)	Part No.
6.3	(47)	(D61)	(0.26)	(0.85)	(160)	(EMZJ6R3ADA470MD61G)
	100	E61	0.26	0.36	240	EMZJ6R3ADA101ME61G
	220	F61	0.26	0.26	300	EMZJ6R3ADA221MF61G
	330	F80	0.26	0.16	600	EMZJ6R3ADA331MF80G
	1,000	HA0	0.26	0.08	850	EMZJ6R3□DA102MHA0G
	1,500	JA0	0.26	0.06	1,190	EMZJ6R3□DA152MJA0G
10	1,800	JA0	0.26	0.06	1,190	EMZJ6R3□DA182MJA0G
	(33)	(D61)	(0.19)	(0.85)	(160)	(EMZJ100ADA330MD61G)
	150	F61	0.19	0.26	300	EMZJ100ADA151MF61G
	680	HA0	0.19	0.08	850	EMZJ100□DA681MHA0G
	1,000	JA0	0.19	0.06	1,190	EMZJ100□DA102MJA0G
16	1,200	JA0	0.19	0.06	1,190	EMZJ100□DA122MJA0G
	(22)	(D61)	(0.16)	(0.85)	(160)	(EMZJ160ADA220MD61G)
	47	E61	0.16	0.36	240	EMZJ160ADA470ME61G
	100	F61	0.16	0.26	300	EMZJ160ADA101MF61G
	150	F80	0.16	0.16	600	EMZJ160ADA151MF80G
	220	F80	0.16	0.16	600	EMZJ160ADA221MF80G
	470	HA0	0.16	0.08	850	EMZJ160□DA471MHA0G
	680	JA0	0.16	0.06	1,190	EMZJ160□DA681MJA0G
25	820	JA0	0.16	0.06	1,190	EMZJ160□DA821MJA0G
	(10)	(D61)	(0.14)	(0.85)	(160)	(EMZJ250ADA100MD61G)
	22	E61	0.14	0.36	240	EMZJ250ADA220ME61G
	33	E61	0.14	0.36	240	EMZJ250ADA330ME61G
	33	F61	0.14	0.26	300	EMZJ250ADA330MF61G
	47	F61	0.14	0.26	300	EMZJ250ADA470MF61G
	68	F61	0.14	0.26	300	EMZJ250ADA680MF61G
	100	F80	0.14	0.16	600	EMZJ250ADA101MF80G
	330	HA0	0.14	0.08	850	EMZJ250□DA331MHA0G
35	470	JA0	0.14	0.06	1,190	EMZJ250□DA471MJA0G
	560	JA0	0.14	0.06	1,190	EMZJ250□DA561MJA0G
	(10)	(D61)	(0.12)	(0.85)	(160)	(EMZJ350ADA100MD61G)
	22	E61	0.12	0.36	240	EMZJ350ADA220ME61G
	33	F61	0.12	0.26	300	EMZJ350ADA330MF61G
	47	F61	0.12	0.26	300	EMZJ350ADA470MF61G
	68	F61	0.12	0.26	300	EMZJ350ADA680MF61G
	100	F80	0.12	0.16	600	EMZJ350ADA101MF80G
	100	HA0	0.12	0.08	850	EMZJ350□DA101MHA0G
	150	HA0	0.12	0.08	850	EMZJ350□DA151MHA0G
35	220	HA0	0.12	0.08	850	EMZJ350□DA221MHA0G
	330	JA0	0.12	0.06	1,190	EMZJ350□DA331MJA0G
	390	JA0	0.12	0.06	1,190	EMZJ350□DA391MJA0G

□ : Enter the appropriate terminal code.

() : Second standard

◆RATED RIPPLE CURRENT MULTIPLIERS

● Frequency Multipliers

Capacitance(µF)	Frequency(Hz)			
	120	1k	10k	100k
10 to 150	0.40	0.75	0.90	1.00
220 to 560	0.50	0.85	0.94	1.00
680 to 1,800	0.60	0.87	0.95	1.00

The endurance of capacitors is reduced with internal heating produced by ripple current at the rate of halving the lifetime with every 5°C rise. When long life performance is required in actual use, the rms ripple current has to be reduced.

Return Group Chart



SURFACE MOUNT ALUMINUM ELECTROLYTIC CAPACITORS

Low impedance, 105°C

Alchip™-MZA Series

- Endurance : 2,000 to 5,000 hours at 105°C
- Low impedance
- Solvent resistant type(see PRECAUTIONS AND GUIDELINES)
- Vibration resistant structure
- RoHS Compliant
- AEC-Q200 compliant : Please contact Chemi-Con for more details, test data, information.

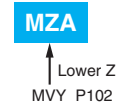

◆SPECIFICATIONS

Items	Characteristics										
Category	-55 to +105°C										
Temperature Range											
Rated Voltage Range	6.3 to 100V _{dc}										
Capacitance Tolerance	±20%(M) (at 20°C, 120Hz)										
Leakage Current	I=0.01CV or 3μA, whichever is greater Where, I : Max. leakage current (μA), C : Nominal capacitance (μF), V : Rated voltage (V) (at 20°C after 2 minutes)										
Dissipation Factor (tan δ)	Rated voltage(V _{dc})	6.3V	10V	16V	25V	35V	50V	63V	80V	100V	
	tan δ(Max.)	D61 to JA0	0.26	0.19	0.16	0.14	0.12	0.10	0.08	0.08	—
		KE0 to MN0	—	—	—	0.16	0.14	0.12	0.12	0.10	0.10
When nominal capacitance exceeds 1,000μF, add 0.02 to the value above for each 1,000μF increase. (at 20°C, 120Hz)											
Low Temperature Characteristics (Max. impedance Ratio)	Rated voltage(V _{dc})	6.3V	10V	16V	25V	35V	50V	63V	80V	100V	
	Z(-25°C)/Z(+20°C)	2	2	2	2	2	2	2	2	2	
	Z(-40°C)/Z(+20°C)	3	3	3	3	3	3	3	3	3	
	Z(-55°C)/Z(+20°C)	4	4	4	3	3	3	3	3	3	
(at 120Hz)											
Endurance	The following specifications shall be satisfied when the capacitors are restored to 20°C after the rated voltage is applied for specified time at 105°C.										
	Time	D61 to JA0 : 2,000 hours KE0 to MN0 : 5,000 hours									
	Capacitance change	≤ ±30% of the initial value									
	D.F. (tan δ)	≤200% of the initial specified value									
	Leakage current	≤The initial specified value									

◆DIMENSIONS [mm]

- Terminal Code : A
- Size code : D61 to MN0

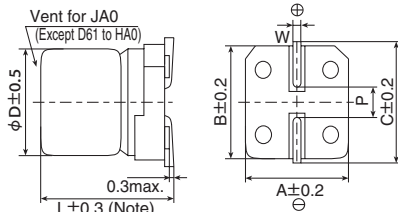

Note : L±0.5 for HA0 and MN0

- Terminal Code : G(Vibration resistant structure)
- Size code : HA0 to MN0

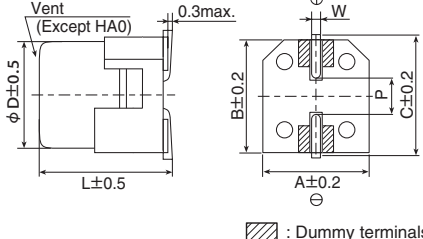

Size code	D	L	A	B	C	W	P
D61	4	5.8	4.3	4.3	5.1	0.5 to 0.8	1.0
E61	5	5.8	5.3	5.3	5.9	0.5 to 0.8	1.4
F61	6.3	5.8	6.6	6.6	7.2	0.5 to 0.8	1.9
F80	6.3	7.7	6.6	6.6	7.2	0.5 to 0.8	1.9
HA0	8	10.0	8.3	8.3	9.0	0.7 to 1.1	3.1
JA0	10	10.0	10.3	10.3	11.0	0.7 to 1.1	4.5
KE0	12.5	13.5	13.0	13.0	13.7	1.0 to 1.3	4.2
KG5	12.5	16.0	13.0	13.0	13.7	1.0 to 1.3	4.2
LH0	16	16.5	17.0	17.0	18.0	1.0 to 1.3	6.5
LN0	16	21.5	17.0	17.0	18.0	1.0 to 1.3	6.5
MH0	18	16.5	19.0	19.0	20.0	1.0 to 1.3	6.5
MN0	18	21.5	19.0	19.0	20.0	1.0 to 1.3	6.5

◆PART NUMBERING SYSTEM

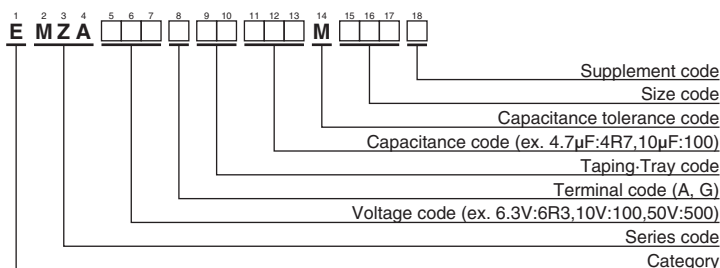

Please refer to "Product code guide (surface mount type)"

◆MARKING



- Rated voltage symbol (D61 to JA0)

Rated voltage (V _{dc})	6.3	10	16	25	35	50	63	80
Symbol	j	A	C	E	V	H	J	K

Return Group Chart



SURFACE MOUNT ALUMINUM ELECTROLYTIC CAPACITORS

Low impedance, 105°C

Alchip™ - **MZA** Series

◆ STANDARD RATINGS

WV (Vdc)	Cap (μF)	Size code	Impedance (Ω max./100kHz)		Rated ripple current (mA rms/105°C, 100kHz)	Part No.	WV (Vdc)	Cap (μF)	Size code	Impedance (Ω max./100kHz)		Rated ripple current (mA rms/105°C, 100kHz)	Part No.
			20°C	-40°C						20°C	-40°C		
6.3	22	D61	1.35	-	90	EMZA6R3ADA220MD61G	35	330	JA0	0.08	-	850	EMZA350 □ DA331MJA0G
	47	D61	1.35	-	90	EMZA6R3ADA470MD61G		620	KE0	0.060	0.30	1,320	EMZA350 □ RA621MKE0S
	47	E61	0.70	-	160	EMZA6R3ADA470ME61G		820	KG5	0.056	0.28	1,470	EMZA350 □ RA821MKG5S
	100	E61	0.70	-	160	EMZA6R3ADA101ME61G		1,200	LH0	0.047	0.24	1,820	EMZA350 □ DA122MLH0S
	100	F61	0.36	-	240	EMZA6R3ADA101MF61G		1,600	MH0	0.045	0.23	2,060	EMZA350 □ DA162MMH0S
	220	F61	0.36	-	240	EMZA6R3ADA221MF61G		1,800	LNO	0.034	0.17	2,400	EMZA350 □ DA182MLN0S
	330	F80	0.34	-	280	EMZA6R3ADA331MF80G		2,400	MNO	0.032	0.16	2,640	EMZA350 □ DA242MMN0S
	470	HA0	0.16	-	600	EMZA6R3 □ DA471MHA0G		4.7	D61	2.9	-	60	EMZA500ADA4R7MD61G
	1,000	HA0	0.16	-	600	EMZA6R3 □ DA102MHA0G		10	E61	1.52	-	85	EMZA500ADA100ME61G
	1,500	JA0	0.08	-	850	EMZA6R3 □ DA152MJA0G		10	F61	0.88	-	165	EMZA500ADA100MF61G
10	22	D61	1.35	-	90	EMZA100ADA220MD61G	22	F61	0.88	-	165	EMZA500ADA220MF61G	
	33	D61	1.35	-	90	EMZA100ADA330MD61G	33	F80	0.68	-	195	EMZA500ADA330MF80G	
	33	E61	0.70	-	160	EMZA100ADA330ME61G	47	F80	0.68	-	195	EMZA500ADA470MF80G	
	220	F80	0.34	-	280	EMZA100ADA220MF80G	100	HA0	0.34	-	350	EMZA500 □ DA101MHA0G	
	330	HA0	0.16	-	600	EMZA100 □ DA331MHA0G	220	JA0	0.18	-	670	EMZA500 □ DA221MJA0G	
	470	HA0	0.16	-	600	EMZA100 □ DA471MHA0G	330	KE0	0.11	0.55	980	EMZA500 □ RA331MKE0S	
	680	HA0	0.16	-	600	EMZA100 □ DA681MHA0G	430	KG5	0.10	0.50	1,090	EMZA500 □ RA431MKG5S	
	1,000	JA0	0.08	-	850	EMZA100 □ DA102MJA0G	620	LH0	0.087	0.44	1,320	EMZA500 □ DA621MLH0S	
	16	10	D61	1.35	-	90	EMZA160ADA100MD61G	820	MH0	0.087	0.44	1,420	EMZA500 □ DA821MMH0S
		22	D61	1.35	-	90	EMZA160ADA220MD61G	1,000	LNO	0.050	0.25	1,910	EMZA500 □ DA102MLN0S
22		E61	0.70	-	160	EMZA160ADA220ME61G	1,300	MNO	0.050	0.25	2,180	EMZA500 □ DA132MMN0S	
47		E61	0.70	-	160	EMZA160ADA470ME61G	4.7	E61	4.8	-	50	EMZA630ADA4R7ME61G	
47		F61	0.36	-	240	EMZA160ADA470MF61G	10	F61	2.2	-	80	EMZA630ADA100MF61G	
100		F61	0.36	-	240	EMZA160ADA101MF61G	22	F80	2.1	-	120	EMZA630ADA220MF80G	
220		F80	0.34	-	280	EMZA160ADA221MF80G	33	HA0	0.70	-	250	EMZA630 □ DA330MHA0G	
330		HA0	0.16	-	600	EMZA160 □ DA331MHA0G	47	HA0	0.70	-	250	EMZA630 □ DA470MHA0G	
470		HA0	0.16	-	600	EMZA160 □ DA471MHA0G	68	HA0	0.70	-	250	EMZA630 □ DA680MHA0G	
680		JA0	0.08	-	850	EMZA160 □ DA681MJA0G	100	JA0	0.45	-	400	EMZA630 □ DA101MJA0G	
25	10	D61	1.35	-	90	EMZA250ADA100MD61G	240	KE0	0.19	1.54	880	EMZA630 □ RA241MKE0S	
	22	E61	0.70	-	160	EMZA250ADA220ME61G	300	KG5	0.17	1.19	1,000	EMZA630 □ RA301MKG5S	
	33	E61	0.70	-	160	EMZA250ADA330ME61G	430	LH0	0.15	1.05	1,220	EMZA630 □ DA431MLH0S	
	33	F61	0.36	-	240	EMZA250ADA330MF61G	560	MH0	0.12	0.84	1,430	EMZA630 □ DA561MMH0S	
	47	F61	0.36	-	240	EMZA250ADA470MF61G	680	LNO	0.085	0.58	1,790	EMZA630 □ DA681MLN0S	
	100	F80	0.34	-	280	EMZA250ADA101MF80G	910	MNO	0.070	0.49	1,960	EMZA630 □ DA911MMN0S	
	220	HA0	0.16	-	600	EMZA250 □ DA221MHA0G	3.3	E61	5.0	-	25	EMZA800ADA3R3ME61G	
	330	HA0	0.16	-	600	EMZA250 □ DA331MHA0G	4.7	F61	3.0	-	40	EMZA800ADA4R7MF61G	
	470	JA0	0.08	-	850	EMZA250 □ DA471MJA0G	10	F80	2.4	-	60	EMZA800ADA100MF80G	
	1,000	KE0	0.060	0.30	1,320	EMZA250 □ RA102MKE0S	22	HA0	1.3	-	130	EMZA800 □ DA220MHA0G	
35	1,300	KG5	0.056	0.28	1,470	EMZA250 □ RA132MKG5S	33	HA0	1.3	-	130	EMZA800 □ DA330MHA0G	
	1,800	LH0	0.047	0.24	1,820	EMZA250 □ DA182MLH0S	47	JA0	0.70	-	200	EMZA800 □ DA470MJA0G	
	2,400	MH0	0.045	0.23	2,060	EMZA250 □ DA242MMH0S	150	KE0	0.22	1.54	810	EMZA800 □ RA151MKE0S	
	3,000	LNO	0.034	0.17	2,400	EMZA250 □ DA302MLN0S	220	KG5	0.17	1.19	1,000	EMZA800 □ RA221MKG5S	
	3,900	MNO	0.032	0.16	2,640	EMZA250 □ DA392MMN0S	330	LH0	0.15	1.05	1,220	EMZA800 □ DA331MLH0S	
	6.3	4.7	D61	1.35	-	90	EMZA350ADA4R7MD61G	430	MH0	0.12	0.84	1,430	EMZA800 □ DA431MMH0S
		10	D61	1.35	-	90	EMZA350ADA100MD61G	470	LNO	0.085	0.58	1,790	EMZA800 □ DA471MLN0S
		10	E61	0.70	-	160	EMZA350ADA100ME61G	680	MNO	0.070	0.49	1,960	EMZA800 □ DA681MMN0S
		22	E61	0.70	-	160	EMZA350ADA220ME61G	110	KE0	0.28	2.24	740	EMZA101 □ RA111MKE0S
		33	F61	0.36	-	240	EMZA350ADA330MF61G	130	KG5	0.21	1.68	900	EMZA101 □ RA131MKG5S
47		F61	0.36	-	240	EMZA350ADA470MF61G	200	LH0	0.18	1.44	1,090	EMZA101 □ DA201MLH0S	
100		F80	0.34	-	280	EMZA350ADA101MF80G	270	MH0	0.15	1.2	1,280	EMZA101 □ DA271MMH0S	
100		HA0	0.16	-	600	EMZA350 □ DA101MHA0G	330	LNO	0.11	0.88	1,580	EMZA101 □ DA331MLN0S	
220		HA0	0.16	-	600	EMZA350 □ DA221MHA0G	430	MNO	0.091	0.73	1,690	EMZA101 □ DA431MMN0S	

□ : Enter the appropriate terminal code.

◆ RATED RIPPLE CURRENT MULTIPLIERS

● Frequency Multipliers

Size code	Capacitance(μF)	Frequency(Hz)			
		120	1k	10k	100k
D61 to JA0	3.3 to 4.7	0.35	0.70	0.90	1.00
	10 to 100	0.40	0.75	0.90	1.00
	220 to 470	0.50	0.85	0.94	1.00
	680 to 1,500	0.60	0.87	0.95	1.00
KE0 to MNO	110 to 200	0.40	0.75	0.90	1.00
	220 to 620	0.50	0.85	0.94	1.00
	680 to 1,800	0.60	0.87	0.95	1.00
	2,400 to 3,000	0.75	0.90	0.95	1.00
	3,900	0.85	0.95	0.98	1.00

The endurance of capacitors is reduced with internal heating produced by ripple current at the rate of halving the lifetime with every 5°C rise. When long life performance is required in actual use, the rms ripple current has to be reduced.

Return Group Chart



SURFACE MOUNT ALUMINUM ELECTROLYTIC CAPACITORS

Low impedance, 105°C

Alchip™-MVY Series

- Endurance : 1,000 to 5,000 hours at 105°C
- Low impedance
- For digital equipment, especially DC-DC converters
- Solvent resistant type except 80 & 100V_{dc} (see PRECAUTIONS AND GUIDELINES)
- Vibration resistant structure
- RoHS Compliant
- AEC-Q200 compliant : Please contact Chemi-Con for more details, test data, information.

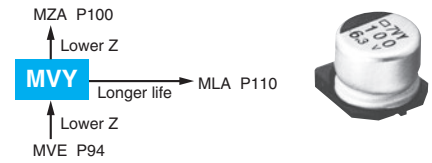

◆ SPECIFICATIONS

Items	Characteristics											
Category	-55 to +105°C (6.3 to 63V _{dc}) -40 to +105°C (80 & 100V _{dc})											
Temperature Range												
Rated Voltage Range	6.3 to 100V _{dc}											
Capacitance Tolerance	±20% (M) (at 20°C, 120Hz)											
Leakage Current	I=0.01CV or 3μA, whichever is greater. Where, I : Max. leakage current (μA), C : Nominal capacitance (μF), V : Rated voltage (V) (at 20°C after 2 minutes)											
Dissipation Factor (tan δ)	Rated voltage (V _{dc})	6.3V	10V	16V	25V	35V	50V	63V	80V	100V	When nominal capacitance exceeds 1,000μF, add 0.02 to the value above for each 1,000μF increase. (at 20°C, 120Hz)	
	tan δ (Max.)	D55 to F80	0.24	0.20	0.16	0.14	0.12	0.12	—	—		—
		HA0 & JA0	0.28	0.24	0.20	0.16	0.14	0.12	—	—		—
Low Temperature Characteristics (Max. Impedance Ratio)	Rated voltage (V _{dc})	6.3V	10V	16V	25V	35V	50V	63V	80V	100V	(at 120Hz)	
	Z(-40°C)/Z(+20°C)	D55 to JA0	3	2	2	2	2	2	—	—		—
		KE0 to MN0	10	8	6	4	3	3	3	3		3
Endurance	The following specifications shall be satisfied when the capacitors are restored to 20°C after the rated voltage is applied for specified time at 105°C.											
	Time	D55 to F80 : 1,000 hours HA0 & JA0 : 2,000 hours KE0 to MN0 : 5,000 hours										
	Rated voltage	6.3V _{dc} (D55 to JA0)					6.3 to 100V _{dc}					
	Capacitance change	≤ ±30% of the initial value					≤ ±20% of the initial value					
	D.F. (tan δ)	≤300% of the initial specified value					≤200% of the initial specified value					
	Leakage current	≤The initial specified value					≤The initial specified value					
Shelf Life	The following specifications shall be satisfied when the capacitors are restored to 20°C after exposing them for 1,000 hours at 105°C without voltage applied. Before the measurement, the capacitor shall be preconditioned by applying voltage according to Item 4.1 of JIS C 5101-4.											
	Rated voltage	6.3V _{dc} (D55 to JA0)					6.3 to 100V _{dc}					
	Capacitance change	≤ ±30% of the initial value					≤ ±20% of the initial value					
	D.F. (tan δ)	≤300% of the initial specified value					≤200% of the initial specified value					
	Leakage current	≤The initial specified value					≤The initial specified value					

◆ DIMENSIONS [mm]

- Terminal Code : A
- Size code : D55 to MN0

- Terminal Code : G (Vibration resistant structure)
- Size code : HA0 to MN0

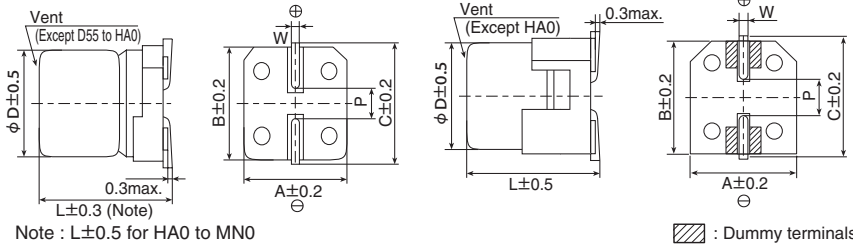

Size code	D	L	A	B	C	W	P
D55	4	5.2	4.3	4.3	5.1	0.5 to 0.8	1.0
E55	5	5.2	5.3	5.3	5.9	0.5 to 0.8	1.4
F55	6.3	5.2	6.6	6.6	7.2	0.5 to 0.8	1.9
F61	6.3	5.8	6.6	6.6	7.2	0.5 to 0.8	1.9
F80	6.3	7.7	6.6	6.6	7.2	0.5 to 0.8	1.9
HA0	8	10.0	8.3	8.3	9.0	0.7 to 1.1	3.1
JA0	10	10.0	10.3	10.3	11.0	0.7 to 1.1	4.5
KE0	12.5	13.5	13.0	13.0	13.7	1.0 to 1.3	4.2
KG5	12.5	16.0	13.0	13.0	13.7	1.0 to 1.3	4.2
LH0	16	16.5	17.0	17.0	18.0	1.0 to 1.3	6.5
LN0	16	21.5	17.0	17.0	18.0	1.0 to 1.3	6.5
MH0	18	16.5	19.0	19.0	20.0	1.0 to 1.3	6.5
MN0	18	21.5	19.0	19.0	20.0	1.0 to 1.3	6.5

◆ PART NUMBERING SYSTEM

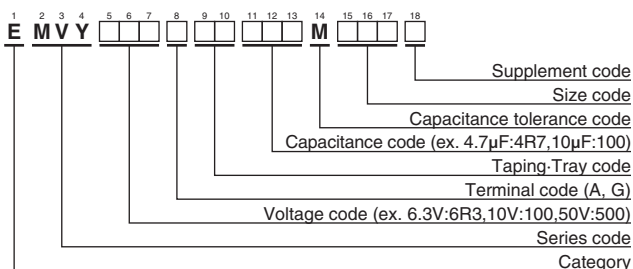

Please refer to "Product code guide (surface mount type)"

◆ MARKING

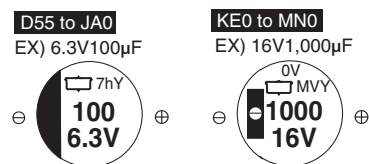

Return Group Chart



SURFACE MOUNT ALUMINUM ELECTROLYTIC CAPACITORS

Low impedance, 10000-hours-life, 105°C

Alchip™-MZF Series

- Endurance : 10,000 hours at 105°C
- Low impedance
- Rated voltage range : 6.3 to 50V
- Nominal capacitance range : 10 to 470μF
- Suitable for long life and low profile products
- Solvent resistant type (see PRECAUTIONS AND GUIDELINES)
- RoHS Compliant

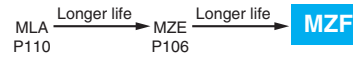

◆ SPECIFICATIONS

Items	Characteristics						
Category	-25 to +105°C						
Temperature Range	-25 to +105°C						
Rated Voltage Range	6.3 to 50V _{dc}						
Capacitance Tolerance	±20%(M) (at 20°C, 120Hz)						
Leakage Current	I=0.01CV or 3μA, whichever is greater Where, I : Max. leakage current (μA), C : Nominal capacitance (μF), V : Rated voltage (V) (at 20°C, after 2 minutes)						
Dissipation Factor (tan δ)	Rated voltage (V _{dc})	6.3V	10V	16V	25V	35V	50V
	tan δ (Max.)	0.32	0.28	0.26	0.16	0.14	0.14
Low Temperature Characteristics (Max. Impedance Ratio)	Rated voltage(V _{dc})	6.3V	10V	16V	25V	35V	50V
	Z(-10°C)/Z(+20°C)	4	3	2	2	2	2
Endurance	The following specifications shall be satisfied when the capacitors are restored to 20°C after the rated voltage is applied for 10,000 hours at 105°C.						
	Capacitance change	≤ ±30% of the initial value					
	D.F. (tan δ)	≤300% of the initial specified value					
	Leakage current	≤The initial specified value					
Shelf Life	The following specifications shall be satisfied when the capacitors are restored to 20°C after exposing them for 1,000 hours at 105°C without voltage applied. Before the measurement, the capacitor shall be preconditioned by applying voltage according to Item 4.1 of JIS C 5101-4.						
	Capacitance change	≤ ±30% of the initial value					
	D.F. (tan δ)	≤300% of the initial specified value					
	Leakage current	≤The initial specified value					

◆ DIMENSIONS [mm]

- Terminal Code : A

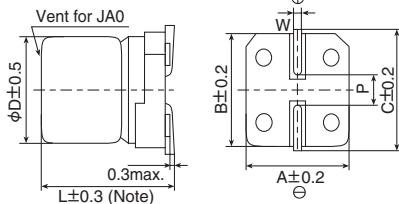

Size code	D	L	A	B	C	W	P
E73	5	7.0	5.3	5.3	5.9	0.5 to 0.8	1.4
F73	6.3	7.0	6.6	6.6	7.2	0.5 to 0.8	1.9
F90	6.3	8.7	6.6	6.6	7.2	0.5 to 0.8	1.9
HA0	8	10.0	8.3	8.3	9.0	0.7 to 1.1	3.1
JA0	10	10.0	10.3	10.3	11.0	0.7 to 1.1	4.5

◆ PART NUMBERING SYSTEM

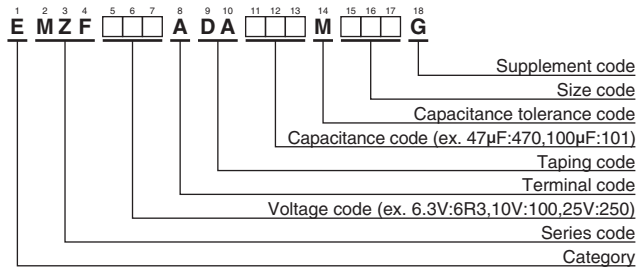

Please refer to "Product code guide (surface mount type)"

◆ MARKING

EX) 16V47μF



- Rated voltage symbol

Rated voltage (V _{dc})	6.3	10	16	25	35	50
Symbol	j	A	C	E	V	H

Return Group Chart



SURFACE MOUNT ALUMINUM ELECTROLYTIC CAPACITORS

Low impedance, 10000-hours-life, 105°C

Alchip™-MZF Series

◆STANDARD RATINGS

WV (V _{dc})	Cap (μF)	Size code	Impedance (Ω max./20°C, 100kHz)	Rated ripple current (mA _{rms} /105°C, 100kHz)	Part No.	WV (V _{dc})	Cap (μF)	Size code	Impedance (Ω max./20°C, 100kHz)	Rated ripple current (mA _{rms} /105°C, 100kHz)	Part No.
6.3	47	E73	2.2	95	EMZF6R3ADA470ME73G	25	33	F73	1.1	140	EMZF250ADA330MF73G
	100	F73	1.1	140	EMZF6R3ADA101MF73G		47	F73	1.1	140	EMZF250ADA470MF73G
	220	F90	1.0	230	EMZF6R3ADA221MF90G		100	F90	1.0	230	EMZF250ADA101MF90G
	330	F90	1.0	230	EMZF6R3ADA331MF90G		220	HA0	0.22	600	EMZF250ADA221MHA0G
	470	HA0	0.22	600	EMZF6R3ADA471MHA0G		330	JA0	0.16	850	EMZF250ADA331MJA0G
10	33	E73	2.2	95	EMZF100ADA330ME73G	35	10	E73	2.2	95	EMZF350ADA100ME73G
	150	F73	1.1	140	EMZF100ADA151MF73G		10	F73	1.1	140	EMZF350ADA100MF73G
16	22	E73	2.2	95	EMZF160ADA220ME73G		22	E73	2.2	95	EMZF350ADA220ME73G
	47	F73	1.1	140	EMZF160ADA470MF73G		22	F73	1.1	140	EMZF350ADA220MF73G
	100	F73	1.1	140	EMZF160ADA101MF73G		33	F90	1.0	230	EMZF350ADA330MF90G
	150	F90	1.0	230	EMZF160ADA151MF90G		47	F90	1.0	230	EMZF350ADA470MF90G
	220	F90	1.0	230	EMZF160ADA221MF90G		100	HA0	0.22	600	EMZF350ADA101MHA0G
	330	HA0	0.22	600	EMZF160ADA331MHA0G		220	JA0	0.16	850	EMZF350ADA221MJA0G
25	470	JA0	0.16	850	EMZF160ADA471MJA0G	50	47	HA0	0.53	350	EMZF500ADA470MHA0G
	22	E73	2.2	95	EMZF250ADA220ME73G		100	JA0	0.35	670	EMZF500ADA101MJA0G

◆RATED RIPPLE CURRENT MULTIPLIERS

●Frequency Multipliers

Capacitance(μF)	Frequency(Hz)			
	120	1k	10k	100k
10 to 150	0.40	0.75	0.90	1.00
220 to 470	0.50	0.85	0.94	1.00

The endurance of capacitors is reduced with internal heating produced by ripple current at the rate of halving the lifetime with every 5°C rise. When long life performance is required in actual use, the rms ripple current has to be reduced.

Return Group Chart



SURFACE MOUNT ALUMINUM ELECTROLYTIC CAPACITORS

Low impedance, 7000 to 8000-hours-life, 105°C

Alchip™-MZE Series

- Endurance : 7,000 to 8,000 hours at 105°C
- Low impedance
- Rated voltage range : 6.3 to 50V
- Nominal capacitance range : 10 to 470μF
- Suitable for long life and low profile products
- Solvent resistant type (see PRECAUTIONS AND GUIDELINES)
- RoHS Compliant

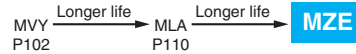

◆ SPECIFICATIONS

Items	Characteristics							
Category	-25 to +105°C							
Temperature Range	-25 to +105°C							
Rated Voltage Range	6.3 to 50V _{dc}							
Capacitance Tolerance	±20%(M) (at 20°C, 120Hz)							
Leakage Current	I=0.01CV or 3μA, whichever is greater Where, I : Max. leakage current (μA), C : Nominal capacitance (μF), V : Rated voltage (V) (at 20°C, after 2 minutes)							
Dissipation Factor (tan δ)	Rated voltage (V _{dc})	6.3V	10V	16V	25V	35V	50V	(at 20°C, 120Hz)
	tan δ (Max.)	0.32	0.28	0.26	0.16	0.14	0.14	
Low Temperature Characteristics (Max. Impedance Ratio)	Rated voltage(V _{dc})	6.3V	10V	16V	25V	35V	50V	(at 120Hz)
	Z(-10°C)/Z(+20°C)	4	3	2	2	2	2	
Endurance	The following specifications shall be satisfied when the capacitors are restored to 20°C after the rated voltage is applied for specified time at 105°C.							
	Time	E73 & F73 : 7,000 hours F90 to JA0 : 8,000 hours						
	Capacitance change	≤ ±30% of the initial value						
	D.F. (tan δ)	≤ 300% of the initial specified value						
	Leakage current	≤ The initial specified value						
Shelf Life	The following specifications shall be satisfied when the capacitors are restored to 20°C after exposing them for 1,000 hours at 105°C without voltage applied. Before the measurement, the capacitor shall be preconditioned by applying voltage according to Item 4.1 of JIS C 5101-4.							
	Capacitance change	≤ ±30% of the initial value						
	D.F. (tan δ)	≤ 300% of the initial specified value						
	Leakage current	≤ The initial specified value						

◆ DIMENSIONS [mm]

● Terminal Code : A

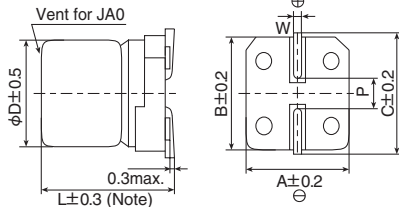

Note : L±0.5 for HA0 and JA0

Size code	D	L	A	B	C	W	P
E73	5	7.0	5.3	5.3	5.9	0.5 to 0.8	1.4
F73	6.3	7.0	6.6	6.6	7.2	0.5 to 0.8	1.9
F90	6.3	8.7	6.6	6.6	7.2	0.5 to 0.8	1.9
HA0	8	10.0	8.3	8.3	9.0	0.7 to 1.1	3.1
JA0	10	10.0	10.3	10.3	11.0	0.7 to 1.1	4.5

◆ PART NUMBERING SYSTEM

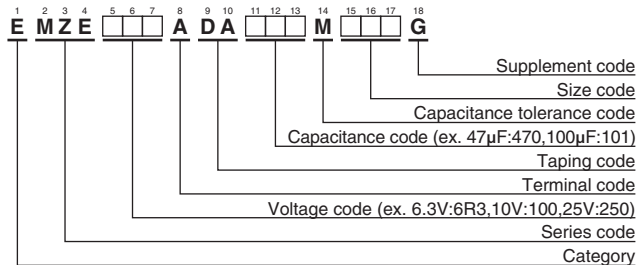

Please refer to "Product code guide (surface mount type)"

◆ MARKING

EX) 16V47μF



● Rated voltage symbol

Rated voltage (V _{dc})	6.3	10	16	25	35	50
Symbol	j	A	C	E	V	H

Return Group Chart



SURFACE MOUNT ALUMINUM ELECTROLYTIC CAPACITORS

Low impedance, 7000 to 8000-hours-life, 105°C

Alchip™-MZE Series

◆STANDARD RATINGS

WV (V _{dc})	Cap (μF)	Size code	Impedance (Ω max./20°C, 100kHz)	Rated ripple current (mA _{rms} /105°C, 100kHz)	Part No.	WV (V _{dc})	Cap (μF)	Size code	Impedance (Ω max./20°C, 100kHz)	Rated ripple current (mA _{rms} /105°C, 100kHz)	Part No.
6.3	47	E73	2.2	95	EMZE6R3ADA470ME73G	25	33	F73	1.1	140	EMZE250ADA330MF73G
	100	F73	1.1	140	EMZE6R3ADA101MF73G		47	F73	1.1	140	EMZE250ADA470MF73G
	220	F90	1.0	230	EMZE6R3ADA221MF90G		100	F90	1.0	230	EMZE250ADA101MF90G
	330	F90	1.0	230	EMZE6R3ADA331MF90G		220	HA0	0.22	600	EMZE250ADA221MHA0G
	470	HA0	0.22	600	EMZE6R3ADA471MHA0G		330	JA0	0.16	850	EMZE250ADA331MJA0G
10	33	E73	2.2	95	EMZE100ADA330ME73G	35	10	E73	2.2	95	EMZE350ADA100ME73G
	150	F73	1.1	140	EMZE100ADA151MF73G		10	F73	1.1	140	EMZE350ADA100MF73G
16	22	E73	2.2	95	EMZE160ADA220ME73G		22	E73	2.2	95	EMZE350ADA220ME73G
	47	F73	1.1	140	EMZE160ADA470MF73G		22	F73	1.1	140	EMZE350ADA220MF73G
	100	F73	1.1	140	EMZE160ADA101MF73G		33	F90	1.0	230	EMZE350ADA330MF90G
	150	F90	1.0	230	EMZE160ADA151MF90G		47	F90	1.0	230	EMZE350ADA470MF90G
	220	F90	1.0	230	EMZE160ADA221MF90G		100	HA0	0.22	600	EMZE350ADA101MHA0G
	330	HA0	0.22	600	EMZE160ADA331MHA0G		220	JA0	0.16	850	EMZE350ADA221MJA0G
25	470	JA0	0.16	850	EMZE160ADA471MJA0G	50	47	HA0	0.53	350	EMZE500ADA470MHA0G
	22	E73	2.2	95	EMZE250ADA220ME73G		100	JA0	0.35	670	EMZE500ADA101MJA0G

◆RATED RIPPLE CURRENT MULTIPLIERS

●Frequency Multipliers

Capacitance(μF)	Frequency(Hz)			
	120	1k	10k	100k
10 to 150	0.40	0.75	0.90	1.00
220 to 470	0.50	0.85	0.94	1.00

The endurance of capacitors is reduced with internal heating produced by ripple current at the rate of halving the lifetime with every 5°C rise. When long life performance is required in actual use, the rms ripple current has to be reduced.

Return Group Chart



SURFACE MOUNT ALUMINUM ELECTROLYTIC CAPACITORS

Low impedance, 5000-hours-life, 105°C

Alchip™-MZK Series

- Endurance : 5,000 hours at 105°C
- Low impedance
- Rated voltage range : 6.3 to 35V
- Nominal capacitance range : 10 to 150μF
- Suitable for low profile products
- Solvent resistant type (see PRECAUTIONS AND GUIDELINES)
- RoHS Compliant

MVY P102 → Longer life → **MZK**



◆ SPECIFICATIONS

Items	Characteristics					
Category	-25 to +105°C					
Temperature Range	-25 to +105°C					
Rated Voltage Range	6.3 to 35V _{dc}					
Capacitance Tolerance	±20%(M) (at 20°C, 120Hz)					
Leakage Current	I=0.01CV or 3μA, whichever is greater Where, I : Max. leakage current (μA), C : Nominal capacitance (μF), V : Rated voltage (V) (at 20°C, after 2 minutes)					
Dissipation Factor (tan δ)	Rated voltage (V _{dc})	6.3V	10V	16V	25V	35V
	tan δ (Max.)	0.32	0.28	0.26	0.16	0.14
Low Temperature Characteristics (Max. Impedance Ratio)	Rated voltage(V _{dc})	6.3V	10V	16V	25V	35V
	Z(-10°C)/Z(+20°C)	4	3	2	2	2
Endurance	The following specifications shall be satisfied when the capacitors are restored to 20°C after the rated voltage is applied for 5,000 hours at 105°C.					
	Capacitance change	≤ ±30% of the initial value				
	D.F. (tan δ)	≤300% of the initial specified value				
	Leakage current	≤The initial specified value				
Shelf Life	The following specifications shall be satisfied when the capacitors are restored to 20°C after exposing them for 1,000 hours at 105°C without voltage applied. Before the measurement, the capacitor shall be preconditioned by applying voltage according to Item 4.1 of JIS C 5101-4.					
	Capacitance change	≤ ±30% of the initial value				
	D.F. (tan δ)	≤300% of the initial specified value				
	Leakage current	≤The initial specified value				

◆ DIMENSIONS [mm]

- Terminal Code : A

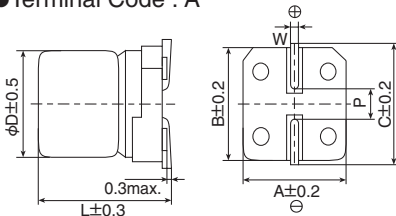

Size code	D	L	A	B	C	W	P
E61	5	5.8	5.3	5.3	5.9	0.5 to 0.8	1.4
F61	6.3	5.8	6.6	6.6	7.2	0.5 to 0.8	1.9

◆ PART NUMBERING SYSTEM

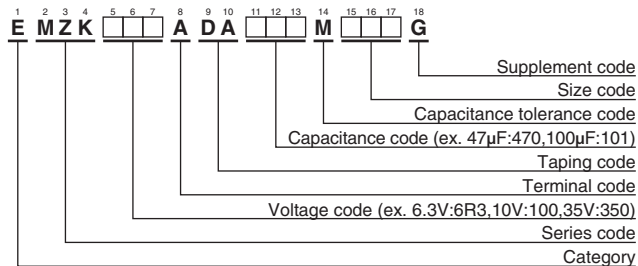

Please refer to "Product code guide (surface mount type)"

◆ MARKING

EX) 35V47μF



- Rated voltage symbol

Rated voltage (V _{dc})	6.3	10	16	25	35
Symbol	j	A	C	E	V

Return Group Chart



SURFACE MOUNT ALUMINUM ELECTROLYTIC CAPACITORS

Low impedance, 5000-hours-life, 105°C

Alchip™ - **MZK** Series

◆STANDARD RATINGS

WV (V _{dc})	Cap (μF)	Size code	Impedance (Ω max./20°C, 100kHz)	Rated ripple current (mA _{rms} /105°C, 100kHz)	Part No.
6.3	100	E61	2.2	95	EMZK6R3ADA101ME61G
10	150	F61	1.1	140	EMZK100ADA151MF61G
16	33	E61	2.2	95	EMZK160ADA330ME61G
	47	E61	2.2	95	EMZK160ADA470ME61G
	100	F61	1.1	140	EMZK160ADA101MF61G
25	68	F61	1.1	140	EMZK250ADA680MF61G
35	10	E61	2.2	95	EMZK350ADA100ME61G
	10	F61	1.1	140	EMZK350ADA100MF61G
	22	E61	2.2	95	EMZK350ADA220ME61G
	22	F61	1.1	140	EMZK350ADA220MF61G
	33	F61	1.1	140	EMZK350ADA330MF61G
	47	F61	1.1	140	EMZK350ADA470MF61G

◆RATED RIPPLE CURRENT MULTIPLIERS

● Frequency Multipliers

Frequency(Hz)	120	1k	10k	100k
6.3 to 35V _{dc}	0.40	0.75	0.90	1.00

The endurance of capacitors is reduced with internal heating produced by ripple current at the rate of halving the lifetime with every 5°C rise. When long life performance is required in actual use, the rms ripple current has to be reduced.

Return Group Chart



SURFACE MOUNT ALUMINUM ELECTROLYTIC CAPACITORS

Low impedance, 105°C

Alchip™-MLA Series

- Low impedance, long life
- Rated voltage 6.3 to 50V, Capacitance 10 to 1,000μF
- Case size φ5×5.8L to φ10×10L
- Suitable for applications requiring long life and low impedance such as equipment in continuous operation, industrial applications, etc.
- Solvent resistant type (see PRECAUTIONS AND GUIDELINES)
- RoHS Compliant

MVY → Longer life → **MLA**
P102



◆ SPECIFICATIONS

Items	Characteristics							
Category	-40 to +105°C							
Temperature Range	-40 to +105°C							
Rated Voltage Range	6.3 to 50V _{dc}							
Capacitance Tolerance	±20%(M) (at 20°C, 120Hz)							
Leakage Current	I=0.01CV or 3μA, whichever is greater Where, I : Max. leakage current (μA), C : Nominal capacitance (μF), V : Rated voltage (V) (at 20°C after 2 minutes)							
Dissipation Factor (tan δ)	Rated voltage(V _{dc})	6.3V	10V	16V	25V	35V	50V	
	tan δ (Max.)	E61 to F61	0.28	0.24	0.22	0.16	0.13	0.12
		F80	0.32	0.27	0.24	0.16	0.13	0.12
		HA0 to JA0	0.28	0.24	0.22	0.16	0.13	0.12
Low Temperature Characteristics (Max. impedance Ratio)	Rated voltage(V _{dc})	6.3V	10V	16V	25V	35V	50V	
	Z(-25°C)/Z(+20°C)	4	3	2	2	2	2	
	Z(-40°C)/Z(+20°C)	10	7	5	3	3	3	
Endurance	The following specifications shall be satisfied when the capacitors are restored to 20°C after the rated voltage is applied for 3,000 hours at 105°C.							
	Capacitance change	≤ ±30% of the initial value						
	D.F. (tan δ)	≤300% of the initial specified value						
	Leakage current	≤The initial specified value						
Shelf life	The following specifications shall be satisfied when the capacitors are restored to 20°C after exposing them for 1,000 hours at 105°C without voltage applied. Before the measurement, the capacitor shall be preconditioned by applying voltage according to Item 4.1 of JIS C 5101-4.							
	Capacitance change	≤ ±30% of the initial value						
	D.F. (tan δ)	≤300% of the initial specified value						
	Leakage current	≤The initial specified value						

◆ DIMENSIONS [mm]

● Terminal Code : A

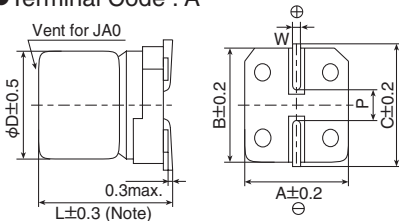

Note : L±0.5 for HA0 and JA0

Size code	D	L	A	B	C	W	P
E61	5	5.8	5.3	5.3	5.9	0.5 to 0.8	1.4
F61	6.3	5.8	6.6	6.6	7.2	0.5 to 0.8	1.9
F80	6.3	7.7	6.6	6.6	7.2	0.5 to 0.8	1.9
HA0	8	10.0	8.3	8.3	9.0	0.7 to 1.1	3.1
JA0	10	10.0	10.3	10.3	11.0	0.7 to 1.1	4.5

◆ MARKING

EX) 16V100μF



◆ PART NUMBERING SYSTEM

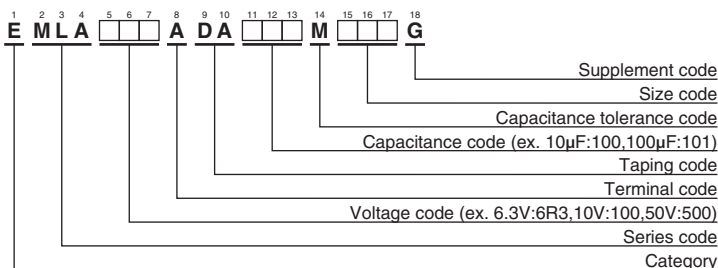

Please refer to "Product code guide (surface mount type)"

● Rated voltage symbol

Rated voltage (V _{dc})	Symbol
6.3	j
10	A
16	C
25	E
35	V
50	H

Return Group Chart



SURFACE MOUNT ALUMINUM ELECTROLYTIC CAPACITORS

Low impedance, 105°C

Alchip™-MLA Series

◆STANDARD RATINGS

WV (V _{ac})	Cap (μF)	Size code	tan δ	Impedance (Ω max./20°C, 100kHz)	Rated ripple current (mA _{rms} /105°C, 100kHz)	Part No.	WV (V _{dc})	Cap (μF)	Size code	tan δ	Impedance (Ω max./20°C, 100kHz)	Rated ripple current (mA _{rms} /105°C, 100kHz)	Part No.
6.3	47	E61	0.28	1.30	95	EMLA6R3ADA470ME61G	25	33	F61	0.16	0.70	140	EMLA250ADA330MF61G
	100	F61	0.28	0.70	140	EMLA6R3ADA101MF61G		47	F61	0.16	0.70	140	EMLA250ADA470MF61G
	150	F61	0.28	0.70	140	EMLA6R3ADA151MF61G		47	F80	0.16	0.70	230	EMLA250ADA470MF80G
	220	F80	0.32	0.70	230	EMLA6R3ADA221MF80G		100	F80	0.16	0.70	230	EMLA250ADA101MF80G
	330	F80	0.32	0.70	230	EMLA6R3ADA331MF80G		100	HA0	0.16	0.16	600	EMLA250ADA101MHA0G
	330	HA0	0.28	0.16	600	EMLA6R3ADA331MHA0G		150	HA0	0.16	0.16	600	EMLA250ADA151MHA0G
	470	HA0	0.28	0.16	600	EMLA6R3ADA471MHA0G		220	HA0	0.16	0.16	600	EMLA250ADA221MHA0G
1,000	JA0	0.28	0.08	850	EMLA6R3ADA102MJA0G	330	HA0	0.16	0.16	600	EMLA250ADA331MHA0G		
10	33	E61	0.24	1.30	95	EMLA100ADA330ME61G	470	JA0	0.16	0.08	850	EMLA250ADA471MJA0G	
	47	F61	0.24	0.70	140	EMLA100ADA470MF61G	35	10	E61	0.13	1.30	95	EMLA350ADA100ME61G
	100	F61	0.24	0.70	140	EMLA100ADA101MF61G		22	F61	0.13	0.70	140	EMLA350ADA220MF61G
	150	F61	0.24	0.70	140	EMLA100ADA151MF61G		33	F61	0.13	0.70	140	EMLA350ADA330MF61G
	220	F80	0.27	0.70	230	EMLA100ADA221MF80G		33	F80	0.13	0.70	230	EMLA350ADA330MF80G
	220	HA0	0.24	0.16	600	EMLA100ADA221MHA0G		47	F80	0.13	0.70	230	EMLA350ADA470MF80G
	330	HA0	0.24	0.16	600	EMLA100ADA331MHA0G		100	F80	0.13	0.70	230	EMLA350ADA101MF80G
470	HA0	0.24	0.16	600	EMLA100ADA471MHA0G	100		HA0	0.13	0.16	600	EMLA350ADA101MHA0G	
16	22	E61	0.22	1.30	95	EMLA160ADA220ME61G	150	HA0	0.13	0.16	600	EMLA350ADA151MHA0G	
	33	F61	0.22	0.70	140	EMLA160ADA330MF61G	220	HA0	0.13	0.16	600	EMLA350ADA221MHA0G	
	47	F61	0.22	0.70	140	EMLA160ADA470MF61G	220	JA0	0.13	0.08	850	EMLA350ADA221MJA0G	
	100	F61	0.22	0.70	140	EMLA160ADA101MF61G	330	JA0	0.13	0.08	850	EMLA350ADA331MJA0G	
	100	F80	0.24	0.70	230	EMLA160ADA101MF80G	50	10	F61	0.12	2.00	70	EMLA500ADA100MF61G
	150	F80	0.24	0.70	230	EMLA160ADA151MF80G		22	F61	0.12	2.00	70	EMLA500ADA220MF61G
	220	F80	0.24	0.70	230	EMLA160ADA221MF80G		33	F80	0.12	1.60	100	EMLA500ADA330MF80G
	220	HA0	0.22	0.16	600	EMLA160ADA221MHA0G		47	F80	0.12	1.60	100	EMLA500ADA470MF80G
	330	HA0	0.22	0.16	600	EMLA160ADA331MHA0G		47	HA0	0.12	0.34	350	EMLA500ADA470MHA0G
	470	HA0	0.22	0.16	600	EMLA160ADA471MHA0G		100	HA0	0.12	0.34	350	EMLA500ADA101MHA0G
470	JA0	0.22	0.08	850	EMLA160ADA471MJA0G	100		JA0	0.12	0.18	670	EMLA500ADA101MJA0G	
25	10	E61	0.16	1.30	95	EMLA250ADA100ME61G	150	JA0	0.12	0.18	670	EMLA500ADA151MJA0G	
	22	E61	0.16	1.30	95	EMLA250ADA220ME61G	220	JA0	0.12	0.18	670	EMLA500ADA221MJA0G	
	22	F61	0.16	0.70	140	EMLA250ADA220MF61G							

◆RATED RIPPLE CURRENT MULTIPLIERS

● Frequency Multipliers

Capacitance(μF)	Frequency(Hz)	120	1k	10k	100k
10 to 150		0.40	0.75	0.90	1.00
220 to 470		0.50	0.85	0.94	1.00
1,000		0.60	0.87	0.95	1.00

The endurance of capacitors is reduced with internal heating produced by ripple current at the rate of halving the lifetime with every 5°C rise. When long life performance is required in actual use, the rms ripple current has to be reduced.

Return Group Chart



SURFACE MOUNT ALUMINUM ELECTROLYTIC CAPACITORS

10000-hours-life, 105°C

Alchip™-MLF Series

- Endurance : 10,000 hours at 105°C
- Rated voltage range : 6.3 to 50V
- Nominal capacitance range : 1.0 to 1,000μF
- Suitable for long life and low profile products
- Solvent resistant type (see PRECAUTIONS AND GUIDELINES)
- RoHS Compliant

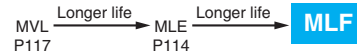

◆ SPECIFICATIONS

Items	Characteristics						
Category	-25 to +105°C						
Temperature Range	-25 to +105°C						
Rated Voltage Range	6.3 to 50V _{dc}						
Capacitance Tolerance	±20%(M) (at 20°C, 120Hz)						
Leakage Current	I=0.03CV or 4μA, whichever is greater Where, I : Max. leakage current (μA), C : Nominal capacitance (μF), V : Rated voltage (V) (at 20°C, after 2 minutes)						
Dissipation Factor (tan δ)	Rated voltage (V _{dc})	6.3V	10V	16V	25V	35V	50V
	tan δ (Max.)	0.32	0.28	0.26	0.16	0.14	0.14
Low Temperature Characteristics (Max. Impedance Ratio)	Rated voltage(V _{dc})	6.3V	10V	16V	25V	35V	50V
	Z(-10°C)/Z(+20°C)	4	3	2	2	2	2
Endurance	The following specifications shall be satisfied when the capacitors are restored to 20°C after the rated voltage is applied for 10,000 hours at 105°C.						
	Capacitance change	≤ ±30% of the initial value					
	D.F. (tan δ)	≤300% of the initial specified value					
	Leakage current	≤The initial specified value					
Shelf Life	The following specifications shall be satisfied when the capacitors are restored to 20°C after exposing them for 1,000 hours at 105°C without voltage applied. Before the measurement, the capacitor shall be preconditioned by applying voltage according to Item 4.1 of JIS C 5101-4.						
	Capacitance change	≤ ±30% of the initial value					
	D.F. (tan δ)	≤300% of the initial specified value					
	Leakage current	≤The initial specified value					

◆ DIMENSIONS [mm]

● Terminal Code : A

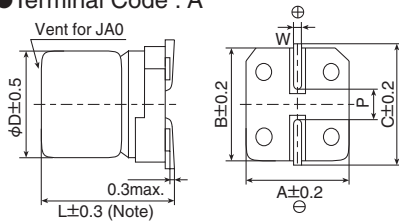

Size code	D	L	A	B	C	W	P
D73	4	7.0	4.3	4.3	5.1	0.5 to 0.8	1.0
E73	5	7.0	5.3	5.3	5.9	0.5 to 0.8	1.4
F73	6.3	7.0	6.6	6.6	7.2	0.5 to 0.8	1.9
F90	6.3	8.7	6.6	6.6	7.2	0.5 to 0.8	1.9
HA0	8	10.0	8.3	8.3	9.0	0.7 to 1.1	3.1
JA0	10	10.0	10.3	10.3	11.0	0.7 to 1.1	4.5

◆ PART NUMBERING SYSTEM

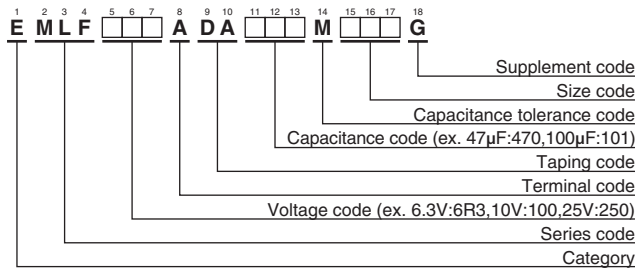

Please refer to "Product code guide (surface mount type)"

◆ MARKING

EX) 16V47μF



● Rated voltage symbol

Rated voltage (V _{dc})	6.3	10	16	25	35	50
Symbol	j	A	C	E	V	H

Return Group Chart



SURFACE MOUNT ALUMINUM ELECTROLYTIC CAPACITORS

10000-hours-life, 105°C

Alchip™-MLF Series

◆STANDARD RATINGS

WV (V _{ac})	Cap (μF)	Size code	Rated ripple current (mA _{rms} /105°C, 120Hz)	Part No.	WV (V _{ac})	Cap (μF)	Size code	Rated ripple current (mA _{rms} /105°C, 120Hz)	Part No.
6.3	22	D73	22	EMLF6R3ADA220MD73G	35	1.0	D73	6.2	EMLF350ADA1R0MD73G
	47	E73	36	EMLF6R3ADA470ME73G		2.2	D73	11	EMLF350ADA2R2MD73G
	100	F73	60	EMLF6R3ADA101MF73G		3.3	D73	14	EMLF350ADA3R3MD73G
	220	F90	101	EMLF6R3ADA221MF90G		4.7	D73	15	EMLF350ADA4R7MD73G
	330	HA0	160	EMLF6R3ADA331MHA0G		4.7	E73	19	EMLF350ADA4R7ME73G
1,000	JA0	313	EMLF6R3ADA102MJA0G	10		E73	25	EMLF350ADA100ME73G	
10	33	E73	35	EMLF100ADA330ME73G		10	F73	30	EMLF350ADA100MF73G
	220	HA0	141	EMLF100ADA221MHA0G		22	F73	42	EMLF350ADA220MF73G
16	10	D73	18	EMLF160ADA100MD73G		22	F90	49	EMLF350ADA220MF90G
	22	E73	30	EMLF160ADA220ME73G		33	F90	57	EMLF350ADA330MF90G
	47	F73	50	EMLF160ADA470MF73G	220	JA0	216	EMLF350ADA221MJA0G	
	100	F90	81	EMLF160ADA101MF90G	33	HA0	77	EMLF500ADA330MHA0G	
	470	JA0	254	EMLF160ADA471MJA0G	47	HA0	92	EMLF500ADA470MHA0G	
25	33	F73	48	EMLF250ADA330MF73G	100	JA0	151	EMLF500ADA101MJA0G	
	47	F90	63	EMLF250ADA470MF90G					
	100	HA0	116	EMLF250ADA101MHA0G					

◆RATED RIPPLE CURRENT MULTIPLIERS

●Frequency Multipliers

Capacitance(μF)	Frequency(Hz)	120	1k	10k	100k
1.0		1.00	1.50	1.75	1.80
2.2 to 10		1.00	1.30	1.40	1.50
22 to 1,000		1.00	1.05	1.08	1.08

The endurance of capacitors is reduced with internal heating produced by ripple current at the rate of halving the lifetime with every 5°C rise. When long life performance is required in actual use, the rms ripple current has to be reduced.

Return Group Chart



SURFACE MOUNT ALUMINUM ELECTROLYTIC CAPACITORS

7000 to 8000-hours-life, 105°C

Alchip™-MLE Series

- Endurance : 7,000 to 8,000 hours at 105°C
- Rated voltage range : 6.3 to 50V
- Nominal capacitance range : 1.0 to 1,000μF
- Suitable for long life and low profile products
- Solvent resistant type (see PRECAUTIONS AND GUIDELINES)
- RoHS Compliant

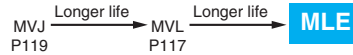

◆ SPECIFICATIONS

Items	Characteristics						
Category	-25 to +105°C						
Temperature Range	-25 to +105°C						
Rated Voltage Range	6.3 to 50V _{dc}						
Capacitance Tolerance	±20%(M) (at 20°C, 120Hz)						
Leakage Current	I=0.03CV or 4μA, whichever is greater Where, I : Max. leakage current (μA), C : Nominal capacitance (μF), V : Rated voltage (V) (at 20°C, after 2 minutes)						
Dissipation Factor (tan δ)	Rated voltage (V _{dc})	6.3V	10V	16V	25V	35V	50V
	tan δ (Max.)	0.32	0.28	0.26	0.16	0.14	0.14
Low Temperature Characteristics (Max. Impedance Ratio)	Rated voltage(V _{dc})	6.3V	10V	16V	25V	35V	50V
	Z(-10°C)/Z(+20°C)	4	3	2	2	2	2
Endurance	The following specifications shall be satisfied when the capacitors are restored to 20°C after the rated voltage is applied for specified time at 105°C.						
Time	D73 to F73 : 7,000 hours F90 to JA0 : 8,000 hours						
Capacitance change	≤ ±30% of the initial value						
D.F. (tan δ)	≤300% of the initial specified value						
Leakage current	≤The initial specified value						
Shelf Life	The following specifications shall be satisfied when the capacitors are restored to 20°C after exposing them for 1,000 hours at 105°C without voltage applied. Before the measurement, the capacitor shall be preconditioned by applying voltage according to Item 4.1 of JIS C 5101-4.						
Capacitance change	≤ ±30% of the initial value						
D.F. (tan δ)	≤300% of the initial specified value						
Leakage current	≤The initial specified value						

◆ DIMENSIONS [mm]

- Terminal Code : A

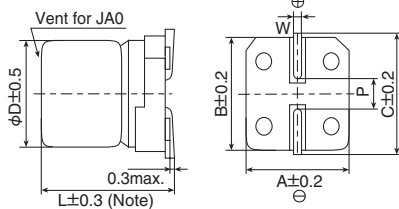

Size code	D	L	A	B	C	W	P
D73	4	7.0	4.3	4.3	5.1	0.5 to 0.8	1.0
E73	5	7.0	5.3	5.3	5.9	0.5 to 0.8	1.4
F73	6.3	7.0	6.6	6.6	7.2	0.5 to 0.8	1.9
F90	6.3	8.7	6.6	6.6	7.2	0.5 to 0.8	1.9
HA0	8	10.0	8.3	8.3	9.0	0.7 to 1.1	3.1
JA0	10	10.0	10.3	10.3	11.0	0.7 to 1.1	4.5

◆ PART NUMBERING SYSTEM

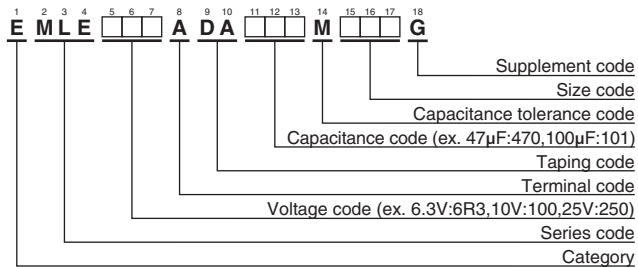

Please refer to "Product code guide (surface mount type)"

◆ MARKING

EX) 16V47μF



- Rated voltage symbol

Rated voltage (V _{dc})	6.3	10	16	25	35	50
Symbol	j	A	C	E	V	H

Return Group Chart



SURFACE MOUNT ALUMINUM ELECTROLYTIC CAPACITORS

7000 to 8000-hours-life, 105°C

Alchip™-MLE Series

◆STANDARD RATINGS

WV (V _{ac})	Cap (μF)	Size code	Rated ripple current (mA _{rms} /105°C, 120Hz)	Part No.	WV (V _{ac})	Cap (μF)	Size code	Rated ripple current (mA _{rms} /105°C, 120Hz)	Part No.	
6.3	22	D73	22	EMLE6R3ADA220MD73G	35	1.0	D73	6.2	EMLE350ADA1R0MD73G	
	47	E73	36	EMLE6R3ADA470ME73G		2.2	D73	11	EMLE350ADA2R2MD73G	
	100	F73	60	EMLE6R3ADA101MF73G		3.3	D73	14	EMLE350ADA3R3MD73G	
	220	F90	101	EMLE6R3ADA221MF90G		4.7	D73	15	EMLE350ADA4R7MD73G	
	330	HA0	160	EMLE6R3ADA331MHA0G		4.7	E73	19	EMLE350ADA4R7ME73G	
	1,000	JA0	313	EMLE6R3ADA102MJA0G		10	E73	25	EMLE350ADA100ME73G	
10	33	E73	35	EMLE100ADA330ME73G		10	F73	30	EMLE350ADA100MF73G	
	220	HA0	141	EMLE100ADA221MHA0G		22	F73	42	EMLE350ADA220MF73G	
16	10	D73	18	EMLE160ADA100MD73G		22	F90	49	EMLE350ADA220MF90G	
	22	E73	30	EMLE160ADA220ME73G		33	F90	57	EMLE350ADA330MF90G	
	47	F73	50	EMLE160ADA470MF73G		220	JA0	216	EMLE350ADA221MJA0G	
	100	F90	81	EMLE160ADA101MF90G		50	33	HA0	77	EMLE500ADA330MHA0G
	470	JA0	254	EMLE160ADA471MJA0G			47	HA0	92	EMLE500ADA470MHA0G
33	F73	48	EMLE250ADA330MF73G	100			JA0	151	EMLE500ADA101MJA0G	
25	47	F90	63	EMLE250ADA470MF90G						
	100	HA0	116	EMLE250ADA101MHA0G						

◆RATED RIPPLE CURRENT MULTIPLIERS

◎Frequency Multipliers

Capacitance(μF)	Frequency(Hz)			
	120	1k	10k	100k
1.0	1.00	1.50	1.75	1.80
2.2 to 10	1.00	1.30	1.40	1.50
22 to 1,000	1.00	1.05	1.08	1.08

The endurance of capacitors is reduced with internal heating produced by ripple current at the rate of halving the lifetime with every 5°C rise. When long life performance is required in actual use, the rms ripple current has to be reduced.

Return Group Chart



SURFACE MOUNT ALUMINUM ELECTROLYTIC CAPACITORS

5000-hours-life, 105°C

Alchip™-MLK Series

- 6.1mm height
- Endurance : 5,000 hours at 105°C
- Rated voltage range : 6.3 to 35V
- Nominal capacitance range : 4.7 to 100μF
- Suitable to fit for downsized equipment
- Solvent resistant type (see PRECAUTIONS AND GUIDELINES)
- RoHS Compliant

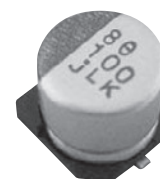
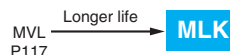

◆ SPECIFICATIONS

Items	Characteristics					
Category	-25 to +105°C					
Temperature Range	-25 to +105°C					
Rated Voltage Range	6.3 to 35V _{dc}					
Capacitance Tolerance	±20%(M) (at 20°C, 120Hz)					
Leakage Current	I=0.03CV or 4μA, whichever is greater Where, I : Max. leakage current (μA), C : Nominal capacitance (μF), V : Rated voltage (V) (at 20°C, after 2 minutes)					
Dissipation Factor (tan δ)	Rated voltage (V _{dc})	6.3V	10V	16V	25V	35V
	tan δ (Max.)	0.32	0.28	0.26	0.16	0.14
Low Temperature Characteristics (Max. Impedance Ratio)	Rated voltage(V _{dc})	6.3V	10V	16V	25V	35V
	Z(-10°C)/Z(+20°C)	4	3	2	2	2
Endurance	The following specifications shall be satisfied when the capacitors are restored to 20°C after the rated voltage is applied for 5,000 hours at 105°C.					
	Capacitance change	≤ ±30% of the initial value				
	D.F. (tan δ)	≤ 300% of the initial specified value				
	Leakage current	≤ The initial specified value				
Shelf Life	The following specifications shall be satisfied when the capacitors are restored to 20°C after exposing them for 1,000 hours at 105°C without voltage applied. Before the measurement, the capacitor shall be preconditioned by applying voltage according to Item 4.1 of JIS C 5101-4.					
	Capacitance change	≤ ±30% of the initial value				
	D.F. (tan δ)	≤ 300% of the initial specified value				
	Leakage current	≤ The initial specified value				

◆ DIMENSIONS [mm]

- Terminal Code : A

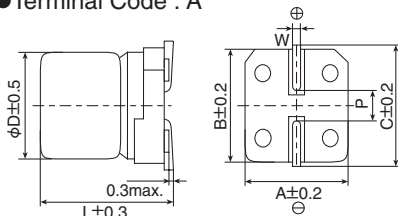

Size code	D	L	A	B	C	W	P
E61	5	5.8	5.3	5.3	5.9	0.5 to 0.8	1.4
F61	6.3	5.8	6.6	6.6	7.2	0.5 to 0.8	1.9

◆ PART NUMBERING SYSTEM

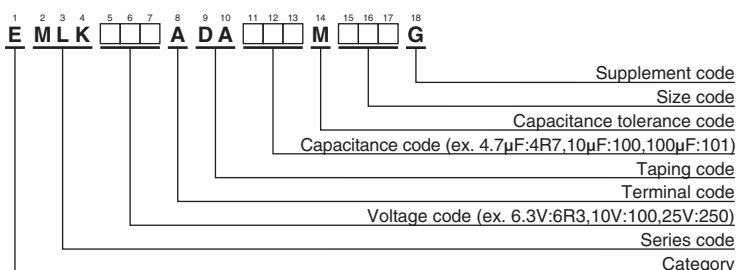

Please refer to "Product code guide (surface mount type)"

◆ MARKING

EX) 35V10μF



- Rated voltage symbol

Rated voltage (V _{dc})	6.3	10	16	25	35
Symbol	j	A	C	E	V

◆ STANDARD RATINGS

WV (V _{dc})	Cap (μF)	Size code	tan δ	Rated ripple current (mA _{rms} /105°C, 120Hz)	Part No.
6.3	47	E61	0.32	36	EMLK6R3ADA470ME61G
	100	F61	0.32	60	EMLK6R3ADA101MF61G
10	33	E61	0.28	35	EMLK100ADA330ME61G
16	22	E61	0.26	30	EMLK160ADA220ME61G
	47	F61	0.26	50	EMLK160ADA470MF61G
25	33	F61	0.16	48	EMLK250ADA330MF61G
35	4.7	E61	0.14	19	EMLK350ADA4R7ME61G
	10	E61	0.14	25	EMLK350ADA100ME61G
	10	F61	0.14	30	EMLK350ADA100MF61G
	22	F61	0.14	42	EMLK350ADA220MF61G

◆ RATED RIPPLE CURRENT MULTIPLIERS

- Frequency Multipliers

Frequency(Hz)	120	1k	10k	100k
6.3 to 35V _{dc}	1.00	1.05	1.08	1.08

The endurance of capacitors is reduced with internal heating produced by ripple current at the rate of halving the lifetime with every 5°C rise. When long life performance is required in actual use, the rms ripple current has to be reduced.

Return Group Chart



SURFACE MOUNT ALUMINUM ELECTROLYTIC CAPACITORS

3000 to 5000-hours-life, 105°C

Alchip™-MVL Series

- Endurance : 3,000 to 5,000 hours at 105°C
- Suitable for applications requiring long life such as continuously operating equipment, industrial applications, etc
- Solvent resistant type (see PRECAUTIONS AND GUIDELINES)
- RoHS Compliant

MVL

Longer life

MVJ P119



◆ SPECIFICATIONS

Items	Characteristics						
Category Temperature Range	-40 to +105°C						
Rated Voltage Range	6.3 to 50V _{dc}						
Capacitance Tolerance	±20%(M) (at 20°C,120Hz)						
Leakage Current	I=0.03CV or 4μA, whichever is greater Where, I : Max. leakage current (μA), C : Nominal capacitance (μF), V : Rated voltage (V) (at 20°C, after 2 minutes)						
Dissipation Factor (tan δ)	Rated voltage (V _{dc})	6.3V	10V	16V	25V	35V	50V
	Max. tan δ	0.28	0.24	0.20	0.16	0.13	0.12
Low Temperature Characteristics (Max. impedance Ratio)	Rated voltage(V _{dc})	6.3V	10V	16V	25V	35V	50V
	Z(-25°C)/Z(+20°C)	4	3	2	2	2	2
	Z(-40°C)/Z(+20°C)	10	7	5	3	3	3
Endurance	The following specifications shall be satisfied when the capacitors are restored to 20°C after the rated voltage is applied for specified time at 105°C.						
	Time	D60 to F80 : 3,000 hours HA0 & JA0 : 5,000 hours					
	Capacitance change	≤ ±30% of the initial value					
	D.F. (tan δ)	≤300% of the initial specified value					
	Leakage current	≤The initial specified value					
Shelf Life	The following specifications shall be satisfied when the capacitors are restored to 20°C after exposing them for 1,000 hours at 105°C without voltage applied. Before the measurement, the capacitor shall be preconditioned by applying voltage according to Item 4.1 of JIS C 5101-4.						
	Capacitance change	≤ ±30% of the initial value					
	D.F. (tan δ)	≤300% of the initial specified value					
	Leakage current	≤The initial specified value					

◆ DIMENSIONS [mm]

● Terminal Code : A

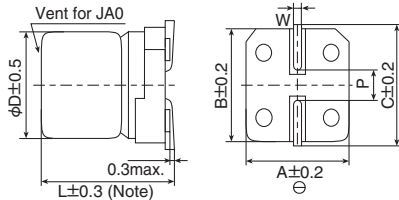

Note : L±0.5 for HA0 and JA0

Size code	D	L	A	B	C	W	P
D60	4	5.7	4.3	4.3	5.1	0.5 to 0.8	1.0
E60	5	5.7	5.3	5.3	5.9	0.5 to 0.8	1.4
F60	6.3	5.7	6.6	6.6	7.2	0.5 to 0.8	1.9
F80	6.3	7.7	6.6	6.6	7.2	0.5 to 0.8	1.9
HA0	8	10.0	8.3	8.3	9.0	0.7 to 1.1	3.1
JA0	10	10.0	10.3	10.3	11.0	0.7 to 1.1	4.5

◆ PART NUMBERING SYSTEM

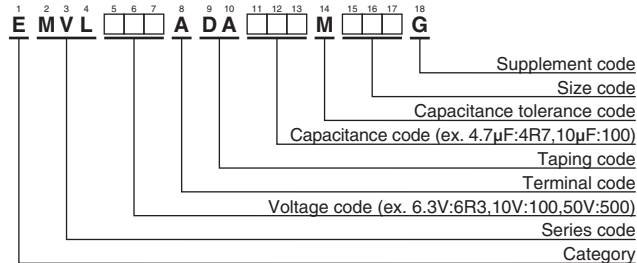

Please refer to "Product code guide (surface mount type)"

◆ MARKING

EX) 16V47μF



Return Group Chart



SURFACE MOUNT ALUMINUM ELECTROLYTIC CAPACITORS

3000 to 5000-hours-life, 105°C

Alchip™-MVL Series

◆STANDARD RATINGS

WV (V _{dc})	Cap (μF)	Size code	tan δ	Rated ripple current (mA _{rms} /105°C, 120Hz)	Part No.	WV (V _{dc})	Cap (μF)	Size code	tan δ	Rated ripple current (mA _{rms} /105°C, 120Hz)	Part No.
6.3	22	D60	0.28	22	EMVL6R3ADA220MD60G	35	4.7	D60	0.13	15	EMVL350ADA4R7MD60G
	47	E60	0.28	36	EMVL6R3ADA470ME60G		10	E60	0.13	25	EMVL350ADA100ME60G
	100	F60	0.28	60	EMVL6R3ADA101MF60G		22	F60	0.13	42	EMVL350ADA220MF60G
	220	F80	0.28	101	EMVL6R3ADA221MF80G		33	F80	0.13	57	EMVL350ADA330MF80G
	330	HA0	0.28	160	EMVL6R3ADA331MHA0G		220	JA0	0.13	216	EMVL350ADA221MJA0G
10	1,000	JA0	0.28	313	EMVL6R3ADA102MJA0G	50	1.0	D60	0.12	6.2	EMVL500ADA1R0MD60G
	33	E60	0.24	35	EMVL100ADA330ME60G		2.2	D60	0.12	11	EMVL500ADA2R2MD60G
220	HA0	0.24	141	EMVL100ADA221MHA0G	3.3		D60	0.12	14	EMVL500ADA3R3MD60G	
16	10	D60	0.20	18	EMVL160ADA100MD60G		4.7	E60	0.12	19	EMVL500ADA4R7ME60G
	22	E60	0.20	30	EMVL160ADA220ME60G		10	F60	0.12	30	EMVL500ADA100MF60G
	47	F60	0.20	50	EMVL160ADA470MF60G		22	F80	0.12	49	EMVL500ADA220MF80G
	100	F80	0.20	81	EMVL160ADA101MF80G		33	HA0	0.12	77	EMVL500ADA330MHA0G
	470	JA0	0.20	254	EMVL160ADA471MJA0G	47	HA0	0.12	92	EMVL500ADA470MHA0G	
25	33	F60	0.16	48	EMVL250ADA330MF60G	100	JA0	0.12	151	EMVL500ADA101MJA0G	
	47	F80	0.16	63	EMVL250ADA470MF80G						
	100	HA0	0.16	116	EMVL250ADA101MHA0G						
	330	JA0	0.16	238	EMVL250ADA331MJA0G						

◆RATED RIPPLE CURRENT MULTIPLIERS

⊙Frequency Multipliers

Capacitance(μF)	Frequency(Hz)			
	120	1k	10k	100k
1.0	1.00	1.50	1.75	1.80
2.2 to 10	1.00	1.30	1.40	1.50
22 to 1,000	1.00	1.05	1.08	1.08

The endurance of capacitors is reduced with internal heating produced by ripple current at the rate of halving the lifetime with every 5°C rise. When long life performance is required in actual use, the rms ripple current has to be reduced.

Return Group Chart



SURFACE MOUNT ALUMINUM ELECTROLYTIC CAPACITORS

2000-hours-life, 105°C

Alchip™-MVJ Series

- Endurance : 2,000 hours at 105°C
- Solvent resistant type (see PRECAUTIONS AND GUIDELINES)
- RoHS Compliant

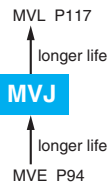

◆ SPECIFICATIONS

Items	Characteristics						
Category Temperature Range	-40 to +105°C						
Rated Voltage Range	6.3 to 50V _{dc}						
Capacitance Tolerance	±20% (M) (at 20°C, 120Hz)						
Leakage Current	I=0.01CV or 3μA, whichever is greater. Where, I : Max. leakage current (μA), C : Nominal capacitance (μF), V : Rated voltage (V) (at 20°C after 2 minutes)						
Dissipation Factor (tan δ)	Rated voltage (V _{dc})	6.3V	10V	16V	25V	35V	50V
	tan δ (Max.)	0.30	0.24	0.20	0.16	0.14	0.12
Low Temperature Characteristics (Max. Impedance Ratio)	Rated voltage (V _{dc})	6.3V	10V	16V	25V	35V	50V
	Z(-25°C)/Z(+20°C)	4	3	2	2	2	2
	Z(-40°C)/Z(+20°C)	12	8	6	4	3	3
Endurance	The following specifications shall be satisfied when the capacitors are restored to 20°C after the rated voltage is applied for 2,000 hours at 105°C.						
	Rated voltage	6.3V _{dc}		10 & 16V _{dc}		25 to 50V _{dc}	
	Capacitance change	≤ ±30% of the initial value		≤ ±25% of the initial value		≤ ±20% of the initial value	
	D.F. (tan δ)	≤ 300% of the initial specified value		≤ 300% of the initial specified value		≤ 200% of the initial specified value	
	Leakage current	≤ The initial specified value		≤ The initial specified value		≤ The initial specified value	
Shelf Life	The following specifications shall be satisfied when the capacitors are restored to 20°C after exposing them for 1,000 hours at 105°C without voltage applied. Before the measurement, the capacitor shall be preconditioned by applying voltage according to Item 4.1 of JIS C 5101-4.						
	Rated voltage	6.3V _{dc}		10 & 16V _{dc}		25 to 50V _{dc}	
	Capacitance change	≤ ±30% of the initial value		≤ ±25% of the initial value		≤ ±20% of the initial value	
	D.F. (tan δ)	≤ 300% of the initial specified value		≤ 300% of the initial specified value		≤ 200% of the initial specified value	
	Leakage current	≤ The initial specified value		≤ The initial specified value		≤ The initial specified value	

◆ DIMENSIONS [mm]

● Terminal Code : A

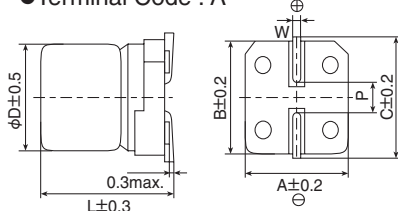

Size code	D	L	A	B	C	W	P
D60	4	5.7	4.3	4.3	5.1	0.5 to 0.8	1.0
E60	5	5.7	5.3	5.3	5.9	0.5 to 0.8	1.4
F60	6.3	5.7	6.6	6.6	7.2	0.5 to 0.8	1.9

◆ PART NUMBERING SYSTEM

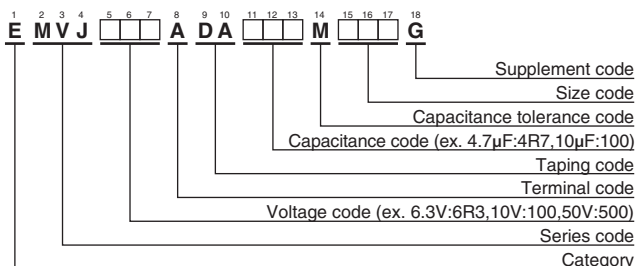

Please refer to "Product code guide (surface mount type)"

◆ MARKING

EX) 6.3V100μF

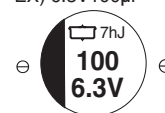

◆ STANDARD RATINGS

WV (V _{dc})	Cap (μF)	Size code	tan δ	Rated ripple current (mA _{rms} /105°C, 120Hz)	Part No.	WV (V _{dc})	Cap (μF)	Size code	tan δ	Rated ripple current (mA _{rms} /105°C, 120Hz)	Part No.
6.3	22	D60	0.30	21	EMVJ6R3ADA220MD60G	35	4.7	D60	0.14	15	EMVJ350ADA4R7MD60G
	47	E60	0.30	36	EMVJ6R3ADA470ME60G		10	E60	0.14	25	EMVJ350ADA100ME60G
	100	F60	0.30	56	EMVJ6R3ADA101MF60G		22	F60	0.14	40	EMVJ350ADA220MF60G
10	33	E60	0.24	34	EMVJ100ADA330ME60G	50	1.0	D60	0.12	5.6	EMVJ500ADA1R0MD60G
16	10	D60	0.20	16	EMVJ160ADA100MD60G		2.2	D60	0.12	10	EMVJ500ADA2R2MD60G
	22	E60	0.20	30	EMVJ160ADA220ME60G		3.3	D60	0.12	14	EMVJ500ADA3R3MD60G
25	47	F60	0.20	48	EMVJ160ADA470MF60G		4.7	E60	0.12	19	EMVJ500ADA4R7ME60G
	33	F60	0.16	45	EMVJ250ADA330MF60G		10	F60	0.12	29	EMVJ500ADA100MF60G

◆ RATED RIPPLE CURRENT MULTIPLIERS

● Frequency Multipliers

Capacitance(μF)	Frequency(Hz)	120	1k	10k	100k
1.0	1.0	1.00	1.50	1.75	1.80
	2.2 to 10	1.00	1.30	1.40	1.50
	22 to 100	1.00	1.05	1.08	1.08

The endurance of capacitors is reduced with internal heating produced by ripple current at the rate of halving the lifetime with every 5°C rise. When long life performance is required in actual use, the rms ripple current has to be reduced.

Return Group Chart



SURFACE MOUNT ALUMINUM ELECTROLYTIC CAPACITORS

High heat resistance, 125°C

Alchip™-MVH Series

- Lower ESR, Higher ripple current
- Endurance : 1,000 to 5,000 hours at 125°C
- Suitable to fit for automotive equipment
- Solvent resistant type except 63 to 450V_{dc} (see PRECAUTIONS AND GUIDELINES)
- Vibration resistant structure
- RoHS Compliant
- AEC-Q200 compliant : Please contact Chemi-Con for more details, test data, information.

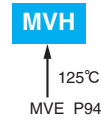

◆ SPECIFICATIONS

Items	Characteristics													
Category	-40 to +125°C													
Temperature Range	-40 to +125°C													
Rated Voltage Range	10 to 450V _{dc}													
Capacitance Tolerance	±20% (M) (at 20°C, 120Hz)													
Leakage Current	Rated voltage (V _{dc})	10 to 100V _{dc}						160 to 450V _{dc}						
	F60 to JA0	I=0.01CV or 3μA, whichever is greater.						I=0.04CV+100						
	KE0 to MN0	I=0.03CV or 4μA, whichever is greater.												
Where, I : Max. leakage current (μA), C : Nominal capacitance (μF), V : Rated voltage (V) (at 20°C after 2 minutes)														
Dissipation Factor (tan δ)	Rated voltage (V _{dc})	10V	16V	25V	35V	50V	63V	80V	100V	160 to 250V	400 & 450V			
	tan δ (Max.)	F60 to JA0	0.24	0.20	0.16	0.14	0.14	0.12	0.12	0.10	—	—		
		KE0 to MN0	0.22	0.18	0.16	0.14	0.12	0.14	—	0.10	0.20	0.24		
When nominal capacitance exceeds 1,000μF, add 0.02 to the value above for each 1,000μF increase. (at 20°C, 120Hz)														
Low Temperature Characteristics (Max. Impedance Ratio)	Rated voltage (V _{dc})	F60 to JA0	Z(-25°C)/Z(+20°C)	3	2	2	2	2	2	2	—	—		
			Z(-40°C)/Z(+20°C)	6	4	4	3	3	3	3	3	—	—	
	KE0 to MN0	Z(-25°C)/Z(+20°C)	4	3	2	2	2	2	—	2	3	6		
		Z(-40°C)/Z(+20°C)	8	6	4	3	3	3	—	3	6	10	(at 120Hz)	
Endurance	The following specifications shall be satisfied when the capacitors are restored to 20°C after the rated voltage is applied for the specified time at 125°C.													
Time	F60 to H63 (10 to 100V _{dc}) : 1,000hours HA0 to JA0 (10 to 100V _{dc}) : 2,000hours KE0 to MN0 (10 to 100V _{dc}) : 5,000hours KE0 to MN0 (160 to 450V _{dc}) : 2,000hours													
Capacitance change	≤ ±30% of the initial value													
D.F. (tan δ)	≤300% of the initial specified value													
Leakage current	≤The initial specified value													
Shelf Life	The following specifications shall be satisfied when the capacitors are restored to 20°C after exposing them for 1,000 hours (500 hours for 400 to 450V _{dc}) at 125°C without voltage applied. Before the measurement, the capacitor shall be preconditioned by applying voltage according to Item 4.1 of JIS C 5101-4.													
Rated voltage(V _{dc})	10 to 50V _{dc}						63 to 450V _{dc}							
Capacitance change	≤ ±30% of the initial value						≤ ±30% of the initial value							
D.F. (tan δ)	≤300% of the initial specified value						≤300% of the initial specified value							
Leakage current	≤The initial specified value						≤500% of the initial specified value							

◆ DIMENSIONS [mm]

- Terminal Code : A
- Size code : F60 to MN0

- Terminal Code : G(Vibration resistant structure)
- Size code : HA0 to MN0

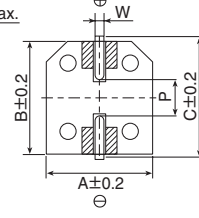
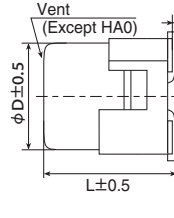
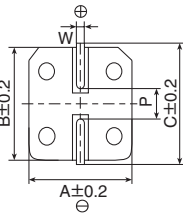
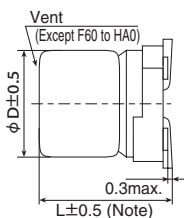

Note : L±0.3 for F60 and F80

▨ : Dummy terminals

Size code	D	L	A	B	C	W	P
F60	6.3	5.7	6.6	6.6	7.2	0.5 to 0.8	1.9
F80	6.3	7.7	6.6	6.6	7.2	0.5 to 0.8	1.9
H63	8	6.3	8.3	8.3	9.0	0.5 to 0.8	2.3
HA0	8	10.0	8.3	8.3	9.0	0.7 to 1.1	3.1
JA0	10	10.0	10.3	10.3	11.0	0.7 to 1.1	4.5
KE0	12.5	13.5	13.0	13.0	13.7	1.0 to 1.3	4.2
KG5	12.5	16.0	13.0	13.0	13.7	1.0 to 1.3	4.2
LH0	16	16.5	17.0	17.0	18.0	1.0 to 1.3	6.5
LNO	16	21.5	17.0	17.0	18.0	1.0 to 1.3	6.5
MH0	18	16.5	19.0	19.0	20.0	1.0 to 1.3	6.5
MNO	18	21.5	19.0	19.0	20.0	1.0 to 1.3	6.5

◆ PART NUMBERING SYSTEM

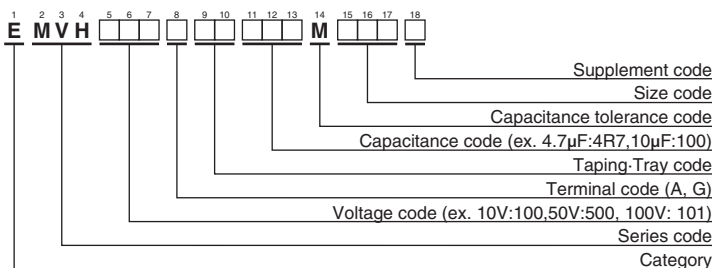

◆ MARKING

F60 to JA0
EX) 35V47μF

KE0 to MN0
EX) 16V1,000μF

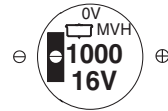
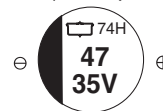

Please refer to "Product code guide (surface mount type)"



Alchip™-MHL Series

- Downsized and Longer life from current MVH series
- Endurance : 2,000 to 4,000 hours at 125°C
- Rated voltage range : 10 to 35V. Nominal capacitance range : 47 to 680μF
- For automobile modules and other high temperature applications
- Solvent resistant type (see PRECAUTIONS AND GUIDELINES)
- Vibration resistant structure
- RoHS Compliant
- AEC-Q200 compliant : Please contact Chemi-Con for more details, test data, information.

MHL

↑ Downsized
Longer life
MVH P120

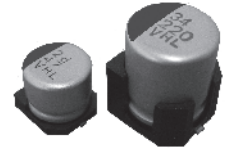

◆ SPECIFICATIONS

Items	Characteristics				
Category	-40 to +125°C				
Temperature Range	-40 to +125°C				
Rated Voltage Range	10 to 35V _{dc}				
Capacitance Tolerance	±20%(M) (at 20°C, 120Hz)				
Leakage Current	I=0.01CV Where, I : Max. leakage current (μA), C : Nominal capacitance (μF), V : Rated voltage (V) (at 20°C after 2 minutes)				
Dissipation Factor (tan δ)	Rated voltage(V _{dc})	10V	16V	25V	35V
	tan δ (Max.)	0.24	0.20	0.16	0.14
Low Temperature Characteristics (Max. impedance Ratio)	Rated voltage(V _{dc})	10V	16V	25V	35V
	Z(-25°C)/Z(+20°C)	3	2	2	2
	Z(-40°C)/Z(+20°C)	4	3	3	3
Endurance	The following specifications shall be satisfied when the capacitors are restored to 20°C after the rated voltage is applied for specified time at 125°C.				
	Time	F61 & F80 : 2,000 hours HA0 & JA0 : 4,000 hours			
	Capacitance change	≤ ±30% of the initial value			
	D.F. (tan δ)	≤ 300% of the initial specified value			
	Leakage current	≤ The initial specified value			
Shelf Life	The following specifications shall be satisfied when the capacitors are restored to 20°C after exposing them for 1,000 hours at 125°C without voltage applied. Before the measurement, the capacitor shall be preconditioned by applying voltage according to Item 4.1 of JIS C 5101-4.				
	Capacitance change	≤ ±30% of the initial value			
	D.F. (tan δ)	≤ 300% of the initial specified value			
	Leakage current	≤ The initial specified value			

◆ DIMENSIONS [mm]

- Terminal Code : A
- Size code : F61 to JA0

- Terminal Code : G(Vibration resistant structure)
- Size code : HA0 and JA0

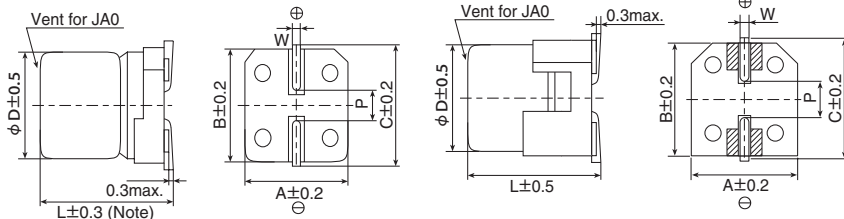

Size code	φD	L	A	B	C	W	P
F61	6.3	5.8	6.6	6.6	7.2	0.5 to 0.8	1.9
F80	6.3	7.7	6.6	6.6	7.2	0.5 to 0.8	1.9
HA0	8	10.0	8.3	8.3	9.0	0.7 to 1.1	3.1
JA0	10	10.0	10.3	10.3	11.0	0.7 to 1.1	4.5

▨ : Dummy terminals

◆ PART NUMBERING SYSTEM

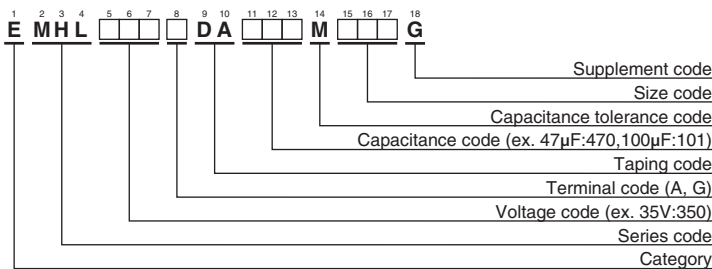

Please refer to "Product code guide (surface mount type)"

◆ MARKING

EX) 35V47μF



● Rated voltage symbol

Rated voltage (V _{dc})	Symbol
10	A
16	C
25	E
35	V

Return Group Chart



SURFACE MOUNT ALUMINUM ELECTROLYTIC CAPACITORS

High heat resistance, 125°C

Alchip™-MHL Series

◆STANDARD RATINGS

WV (V _{dc})	Cap (μF)	Size code	Impedance (Ω max./100kHz)		Rated ripple current (mA _{rms} /125°C, 100kHz)	Part No.
			20°C	-40°C		
10	100	F61	1.2	22	110	EMHL100ADA101MF61G
	220	F80	0.60	12	220	EMHL100ADA221MF80G
	330	HA0	0.30	5.5	296	EMHL100 □ DA331MHA0G
	470	HA0	0.30	5.5	296	EMHL100 □ DA471MHA0G
	680	JA0	0.20	3.6	440	EMHL100 □ DA681MJA0G
16	47	F61	1.2	22	110	EMHL160ADA470MF61G
	100	F61	1.2	22	110	EMHL160ADA101MF61G
	220	F80	0.60	12	220	EMHL160ADA221MF80G
	330	HA0	0.30	5.5	296	EMHL160 □ DA331MHA0G
	470	JA0	0.20	3.6	440	EMHL160 □ DA471MJA0G
	680	JA0	0.20	3.6	440	EMHL160 □ DA681MJA0G
25	47	F61	1.2	22	110	EMHL250ADA470MF61G
	100	F80	0.60	12	220	EMHL250ADA101MF80G
	220	HA0	0.30	5.5	296	EMHL250 □ DA221MHA0G
	330	JA0	0.20	3.6	440	EMHL250 □ DA331MJA0G
35	47	F61	1.2	22	110	EMHL350ADA470MF61G
	100	F80	0.60	12	220	EMHL350ADA101MF80G
	220	HA0	0.30	5.5	296	EMHL350 □ DA221MHA0G
	330	JA0	0.20	3.6	440	EMHL350 □ DA331MJA0G

□ : Enter the appropriate terminal code.

◆RATED RIPPLE CURRENT MULTIPLIERS

●Frequency Multipliers

Capacitance(μF)	Frequency(Hz)			
	120	1k	10k	100k
47 to 680	0.93	0.97	1.00	1.00

The endurance of capacitors is reduced with internal heating produced by ripple current at the rate of halving the lifetime with every 5°C rise. When long life performance is required in actual use, the rms ripple current has to be reduced.

Return Group Chart



SURFACE MOUNT ALUMINUM ELECTROLYTIC CAPACITORS

High heat resistance, 125°C

Alchip™-MHB Series

- ESR : Less than MVH
- Endurance : 1,500 to 3,000 hours at 125°C
- Rated voltage range : 10 to 100V
- Solvent resistant type (see PRECAUTIONS AND GUIDELINES)
- Vibration resistant structure
- RoHS Compliant
- AEC-Q200 compliant : Please contact Chemi-Con for more details, test data, information.

◆ SPECIFICATIONS

Items	Characteristics									
Category	-40 to +125°C									
Temperature Range	-40 to +125°C									
Rated Voltage Range	10 to 100V _{dc}									
Capacitance Tolerance	±20%(M) (at 20°C, 120Hz)									
Leakage Current	HA0 & JA0	I=0.01CV								
	KE0 to MNO	I=0.03CV								
Where, I : Max. leakage current (μA), C : Nominal capacitance (μF), V : Rated voltage (V) (at 20°C after 2 minutes)										
Dissipation Factor (tan δ)	Rated Voltage (V _{dc})	10V	16V	25V	35V	50V	63V	80V	100V	
	tan δ (Max.)	HA0 & JA0	0.24	0.20	0.16	0.14	—	—	—	—
		KE0 to MNO	—	—	0.14	0.12	0.10	0.10	0.08	0.08
When nominal capacitance exceeds 1,000μF, add 0.02 to the value above for each 1,000μF increase. (at 20°C, 120Hz)										
Low Temperature Characteristics (Max. impedance Ratio)	Rated Voltage (V _{dc})	10V	16V	25V	35V	50V	63V	80V	100V	
	HA0 & JA0	Z(-25°C)/Z(+20°C)	3	2	2	2	—	—	—	—
		Z(-40°C)/Z(+20°C)	4	3	3	3	—	—	—	—
	KE0 to MNO	Z(-25°C)/Z(+20°C)	—	—	2	2	2	2	2	2
Z(-40°C)/Z(+20°C)		—	—	4	4	4	4	4	4	
(at 120Hz)										
Endurance	HA0 & JA0	The following specifications shall be satisfied when the capacitors are restored to 20°C after the rated voltage is applied for 2,000 hours at 125°C.								
		Capacitance change	≤ ±30% of the initial value							
		D.F. (tan δ)	≤ 300% of the initial specified value							
	KE0 to MNO	The following specifications shall be satisfied when the capacitors are restored to 20°C after subjected to DC voltage with the rated ripple current is applied (the peak voltage shall not exceed the rated voltage) for the specified period of time at 125°C.								
		Time	KE0 & KG5 : 1,500hours LH0 & MH0 : 2,000hours KN0 & LN0 & MNO : 3,000hours							
		Capacitance change	≤ ±30% of the initial value							
Shelf Life	The following specifications shall be satisfied when the capacitors are restored to 20°C after exposing them for 1,000 hours at 125°C without voltage applied. Before the measurement, the capacitor shall be preconditioned by applying voltage according to Item 4.1 of JIS C 5101-4.									
	Capacitance change	≤ ±30% of the initial value								
	D.F. (tan δ)	≤ 300% of the initial specified value								
Leakage current ≤ The initial specified value										

MHJ P126
↑ Lower ESR
MHB
↑ Lower ESR
MVH P120

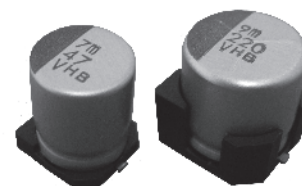

◆ DIMENSIONS [mm]

- Terminal Code : A
- Size code : HA0 to MNO

- Terminal Code : G (Vibration resistant structure)
- Size code : HA0 to MNO

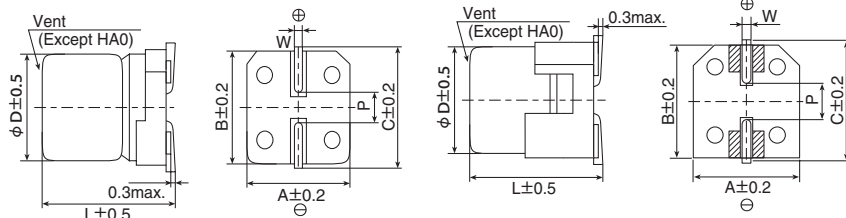

Size code	φD	L	A	B	C	W	P
HA0	8	10.0	8.3	8.3	9.0	0.7 to 1.1	3.1
JA0	10	10.0	10.3	10.3	11.0	0.7 to 1.1	4.5
KE0	12.5	13.5	13.0	13.0	13.7	1.0 to 1.3	4.2
KG5	12.5	16.0	13.0	13.0	13.7	1.0 to 1.3	4.2
KN0	12.5	21.5	13.0	13.0	13.7	1.0 to 1.3	4.2
LH0	16	16.5	17.0	17.0	18.0	1.0 to 1.3	6.5
LN0	16	21.5	17.0	17.0	18.0	1.0 to 1.3	6.5
MH0	18	16.5	19.0	19.0	20.0	1.0 to 1.3	6.5
MNO	18	21.5	19.0	19.0	20.0	1.0 to 1.3	6.5

▨ : Dummy terminals

◆ PART NUMBERING SYSTEM

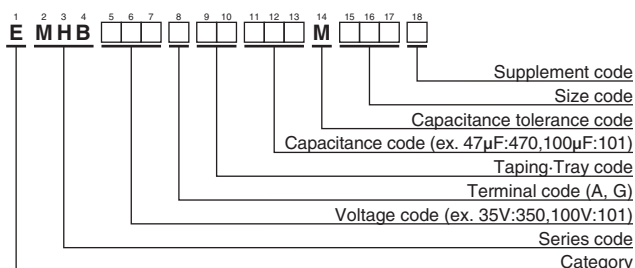

Please refer to "Product code guide (surface mount type)"

◆ MARKING

HA0, JA0
EX) 16V220μF

KE0 to MNO
EX) 35V1,000μF

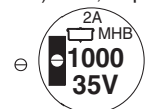

- Rated voltage symbol (HA0, JA0)

Rated voltage (V _{dc})	10	16	25	35
Symbol	A	C	E	V

Return Group Chart



SURFACE MOUNT ALUMINUM ELECTROLYTIC CAPACITORS

Low impedance, 105°C

Alchip™-MHB Series

◆ STANDARD RATINGS

WV (V _{dc})	Cap (μF)	Size code	ESR(Initial) (Ω max./100k to 400kHz)		ESR(End of life) (Ω max.)			Rated ripple current (mA _{rms} /125°C, 100k to 400kHz)	Part No.
			20°C	-40°C	100kHz		400kHz		
					20°C	-40°C			
10	330	HA0	0.3	3.0	-	-	6.0	240	EMHB100 □ DA331MHA0G
	470	JA0	0.2	2.0	-	-	4.5	330	EMHB100 □ DA471MJA0G
16	100	HA0	0.3	3.0	-	-	6.0	240	EMHB160 □ DA101MHA0G
	220	HA0	0.3	3.0	-	-	6.0	240	EMHB160 □ DA221MHA0G
25	100	HA0	0.3	3.0	-	-	6.0	240	EMHB250 □ DA101MHA0G
	220	HA0	0.3	3.0	-	-	6.0	240	EMHB250 □ DA221MHA0G
	330	JA0	0.2	2.0	-	-	4.5	330	EMHB250 □ DA331MJA0G
	820	KE0	0.060	0.30	0.30	3.7	-	1,320	EMHB250 □ RA821MKE0S
	1,100	KG5	0.056	0.28	0.28	3.4	-	1,470	EMHB250 □ RA112MKG5S
	(1,500)	(KN0)	(0.044)	(0.22)	(0.18)	(2.2)	-	(1,620)	(EMHB250 □ TR152MKN0S)
	1,600	LH0	0.047	0.24	0.24	2.9	-	1,820	EMHB250 □ DA162MLH0S
	2,200	MH0	0.045	0.23	0.23	2.8	-	2,000	EMHB250 □ DA222MMH0S
	2,700	LN0	0.034	0.17	0.10	1.3	-	2,280	EMHB250 □ DA272MLN0S
	3,300	MN0	0.032	0.16	0.090	0.60	-	2,490	EMHB250 □ DA332MMN0S
35	47	HA0	0.3	3.0	-	-	6.0	240	EMHB350 □ DA470MHA0G
	100	HA0	0.3	3.0	-	-	6.0	240	EMHB350 □ DA101MHA0G
	100	JA0	0.2	2.0	-	-	4.5	330	EMHB350 □ DA101MJA0G
	220	JA0	0.2	2.0	-	-	4.5	330	EMHB350 □ DA221MJA0G
	560	KE0	0.060	0.30	0.30	3.7	-	1,320	EMHB350 □ RA561MKE0S
	680	KG5	0.056	0.28	0.28	3.4	-	1,470	EMHB350 □ RA681MKG5S
	(910)	(KN0)	(0.044)	(0.22)	(0.18)	(2.2)	-	(1,620)	(EMHB350 □ TR911MKN0S)
	1,000	LH0	0.047	0.24	0.24	2.9	-	1,820	EMHB350 □ DA102MLH0S
	1,300	MH0	0.045	0.23	0.23	2.8	-	2,000	EMHB350 □ DA132MMH0S
	1,600	LN0	0.034	0.17	0.10	1.3	-	2,280	EMHB350 □ DA162MLN0S
2,200	MN0	0.032	0.16	0.090	0.60	-	2,490	EMHB350 □ DA222MMN0S	
50	270	KE0	0.11	0.55	0.55	6.6	-	980	EMHB500 □ RA271MKE0S
	360	KG5	0.10	0.50	0.50	6.0	-	1,090	EMHB500 □ RA361MKG5S
	(470)	(KN0)	(0.076)	(0.38)	(0.38)	(4.6)	-	(1,200)	(EMHB500 □ TR471MKN0S)
	510	LH0	0.087	0.44	0.44	5.2	-	1,320	EMHB500 □ DA511MLH0S
	680	MH0	0.087	0.44	0.44	5.2	-	1,420	EMHB500 □ DA681MMH0S
	820	LN0	0.050	0.25	0.25	3.0	-	2,040	EMHB500 □ DA821MLN0S
	1,100	MN0	0.050	0.25	0.25	3.0	-	2,240	EMHB500 □ DA112MMN0S
63	200	KE0	0.22	1.54	0.88	14	-	540	EMHB630 □ RA201MKE0S
	270	KG5	0.17	1.19	0.68	11	-	650	EMHB630 □ RA271MKG5S
	(330)	(KN0)	(0.13)	(0.94)	(0.53)	(8.5)	-	(830)	(EMHB630 □ TR331MKN0S)
	360	LH0	0.15	1.05	0.60	9.6	-	780	EMHB630 □ DA361MLH0S
	470	MH0	0.12	0.84	0.48	7.7	-	940	EMHB630 □ DA471MMH0S
	560	LN0	0.085	0.58	0.19	3.0	-	1,790	EMHB630 □ DA561MLN0S
750	MN0	0.070	0.49	0.19	3.0	-	1,910	EMHB630 □ DA751MMN0S	
80	130	KE0	0.22	1.54	0.88	14	-	540	EMHB800 □ RA131MKE0S
	160	KG5	0.17	1.19	0.68	11	-	650	EMHB800 □ RA161MKG5S
	(220)	(KN0)	(0.13)	(0.94)	(0.53)	(8.5)	-	(830)	(EMHB800 □ TR221MKN0S)
	240	LH0	0.15	1.05	0.60	9.6	-	780	EMHB800 □ DA241MLH0S
	330	MH0	0.12	0.84	0.48	7.7	-	940	EMHB800 □ DA331MMH0S
	390	LN0	0.085	0.58	0.19	3.0	-	1,790	EMHB800 □ DA391MLN0S
510	MN0	0.070	0.49	0.19	3.0	-	1,910	EMHB800 □ DA511MMN0S	
100	75	KE0	0.28	2.24	1.1	22	-	480	EMHB101 □ RA750MKE0S
	100	KG5	0.21	1.68	0.84	17	-	580	EMHB101 □ RA101MKG5S
	(130)	(KN0)	(0.17)	(1.32)	(0.66)	(13)	-	(740)	(EMHB101 □ TR131MKN0S)
	130	LH0	0.18	1.44	0.72	14	-	720	EMHB101 □ DA131MLH0S
	180	MH0	0.15	1.20	0.60	12	-	840	EMHB101 □ DA181MMH0S
	220	LN0	0.11	0.88	0.25	3.9	-	1,580	EMHB101 □ DA221MLN0S
300	MN0	0.091	0.73	0.22	3.9	-	1,690	EMHB101 □ DA301MMN0S	

□ : Enter the appropriate terminal code.

() : Second standard

◆ RATED RIPPLE CURRENT MULTIPLIERS

● Frequency Multipliers

Size code	Capacitance(μF)	Frequency(Hz)			
		120	1k	10k	100k
HA0 to JA0	47 to 470	0.93	0.97	1.00	1.00
	75 to 200	0.40	0.75	0.90	1.00
KE0 to MN0	220 to 560	0.50	0.85	0.94	1.00
	680 to 1,600	0.60	0.87	0.95	1.00
	2,200 to 3,300	0.75	0.90	0.95	1.00

The endurance of capacitors is reduced with internal heating produced by ripple current at the rate of halving the lifetime with every 5°C rise. When long life performance is required in actual use, the rms ripple current has to be reduced.

Product specifications in this catalog are subject to change without notice. Request our product specifications before purchase and/or use. Please use our products based on the information contained in this catalog and product specifications.

Return Group Chart



SURFACE MOUNT ALUMINUM ELECTROLYTIC CAPACITORS

High heat resistance, 125°C

Alchip™-MHJ Series

- Endurance : 2,000 to 3,000 hours at 125°C
- Rated voltage range : 10 to 35V
- Nominal capacitance range : 47 to 470μF
- Solvent resistant type (see PRECAUTIONS AND GUIDELINES)
- Vibration resistant structure
- RoHS Compliant
- AEC-Q200 compliant : Please contact Chemi-Con for more details, test data, information.

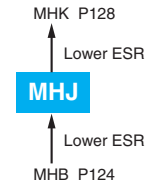

◆ SPECIFICATIONS

Items	Characteristics			
Category	-40 to +125°C			
Temperature Range	-40 to +125°C			
Rated Voltage Range	10 to 35V _{dc}			
Capacitance Tolerance	±20%(M) (at 20°C, 120Hz)			
Leakage Current	I=0.01CV Where, I : Max. leakage current (μA), C : Nominal capacitance (μF), V : Rated voltage (V) (at 20°C after 2 minutes)			
Dissipation Factor (tan δ)	Rated voltage(V _{dc})	10V	16V	25V 35V
	tan δ (Max.)	0.30	0.23	0.18 0.16
Low Temperature Characteristics (Max. impedance Ratio)	Rated voltage(V _{dc})	10V	16V	25V 35V
	Z(-25°C)/Z(+20°C)	3	2	2 2
	Z(-40°C)/Z(+20°C)	4	3	3 3
Endurance	The following specifications shall be satisfied when the capacitors are restored to 20°C after the rated voltage is applied for 3,000 hours (2,000 hours for F80 size) at 125°C.			
	Capacitance change	≤ ±30% of the initial value		
	D.F. (tan δ)	≤ 300% of the initial specified value		
	Leakage current	≤ The initial specified value		
	ESR after 2,000 hours (Ω max./100kHz)		F80	HA0
20°C		3.5	0.60	0.40
Shelf Life	The following specifications shall be satisfied when the capacitors are restored to 20°C after exposing them for 1,000 hours at 125°C without voltage applied. Before the measurement, the capacitor shall be preconditioned by applying voltage according to Item 4.1 of JIS C 5101-4.			
	Capacitance change	≤ ±30% of the initial value		
	D.F. (tan δ)	≤ 300% of the initial specified value		
	Leakage current	≤ The initial specified value		
			F80	HA0

◆ DIMENSIONS [mm]

- Terminal Code : A
- Size code : F80 to JA0

- Terminal Code : G(Vibration resistant structure)
- Size code : HA0 to JA0

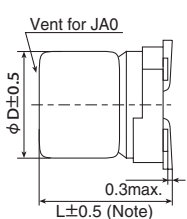

Note : L±0.3 for F80

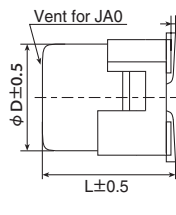
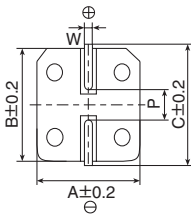

▨ : Dummy terminals

Size code	φD	L	A	B	C	W	P
F80	6.3	7.7	6.6	6.6	7.2	0.5 to 0.8	1.9
HA0	8	10.0	8.3	8.3	9.0	0.7 to 1.1	3.1
JA0	10	10.0	10.3	10.3	11.0	0.7 to 1.1	4.5

◆ PART NUMBERING SYSTEM

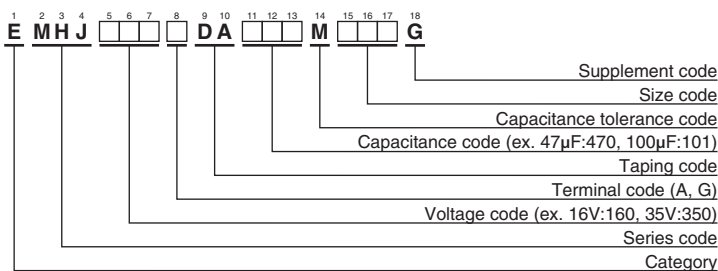

Please refer to "Product code guide (surface mount type)"

◆ MARKING

EX) 16V100μF



- Rated voltage symbol

Rated voltage (V _{dc})	Symbol
10	A
16	C
25	E
35	V

Return Group Chart



SURFACE MOUNT ALUMINUM ELECTROLYTIC CAPACITORS

High heat resistance, 125°C

Alchip™-MHJ Series

◆STANDARD RATINGS

WV (V _{dc})	Cap (μF)	Size code	ESR (Ω max./100kHz)		Rated ripple current (mA _{rms} /125°C, 100kHz)	Part No.
			20°C	-40°C		
10	220	HA0	0.15	3.0	350	EMHJ100□DA221MHA0G
	330	HA0	0.15	3.0	350	EMHJ100□DA331MHA0G
	330	JA0	0.12	2.0	550	EMHJ100□DA331MJA0G
	470	JA0	0.12	2.0	550	EMHJ100□DA471MJA0G
16	100	F80	0.45	5.0	220	EMHJ160ADA101MF80G
	100	HA0	0.15	3.0	350	EMHJ160□DA101MHA0G
	220	HA0	0.15	3.0	350	EMHJ160□DA221MHA0G
	330	JA0	0.12	2.0	550	EMHJ160□DA331MJA0G
	470	JA0	0.12	2.0	550	EMHJ160□DA471MJA0G
25	100	HA0	0.15	3.0	350	EMHJ250□DA101MHA0G
	220	JA0	0.12	2.0	550	EMHJ250□DA221MJA0G
	330	JA0	0.12	2.0	550	EMHJ250□DA331MJA0G
35	47	F80	0.45	5.0	220	EMHJ350ADA470MF80G
	47	HA0	0.15	3.0	350	EMHJ350□DA470MHA0G
	100	HA0	0.15	3.0	350	EMHJ350□DA101MHA0G
	220	JA0	0.12	2.0	550	EMHJ350□DA221MJA0G

□ : Enter the appropriate terminal code.

◆RATED RIPPLE CURRENT MULTIPLIERS

●Frequency Multipliers

Capacitance(μF)	Frequency(Hz)	120	1k	10k	100k
47 to 100		0.40	0.75	0.90	1.00
220 to 470		0.50	0.85	0.94	1.00

The endurance of capacitors is reduced with internal heating produced by ripple current at the rate of halving the lifetime with every 5°C rise. When long life performance is required in actual use, the rms ripple current has to be reduced.

Return Group Chart



SURFACE MOUNT ALUMINUM ELECTROLYTIC CAPACITORS

High heat resistance, 125°C

Alchip™-MHK Series

- Endurance : 2,000 hours at 125°C
- Specified ESR after endurance
- For automobile modules and other high temperature applications
- Solvent resistant type (see PRECAUTIONS AND GUIDELINES)
- RoHS Compliant
- AEC-Q200 compliant : Please contact Chemi-Con for more details, test data, information.

MHK
↑ Lower ESR
MHJ P126



◆ SPECIFICATIONS

Items	Characteristics	
Category		
Temperature Range	-40 to +125°C	
Rated Voltage Range	35V _{dc}	
Capacitance Tolerance	±20%(M) (at 20°C, 120Hz)	
Leakage Current	I=0.01CV Where, I : Max. leakage current (μA), C : Nominal capacitance (μF), V : Rated voltage (V) (at 20°C after 2 minute)	
Dissipation Factor (tan δ)	Rated voltage(V _{dc})	35V
	tan δ (Max.)	0.14 (at 20°C, 120Hz)
Low Temperature Characteristics (Max. impedance Ratio)	Rated voltage(V _{dc})	35V
	Z(-25°C)/Z(+20°C)	2
	Z(-40°C)/Z(+20°C)	3 (at 120Hz)
Endurance	The following specifications shall be satisfied when the capacitors are restored to 20°C after the rated voltage is applied for 2,000 hours at 125°C.	
	Capacitance change	≤ ±30% of the initial value
	D.F. (tan δ)	≤300% of the initial specified value
	Leakage current	≤The initial specified value
	ESR(Ω max./-40°C, 400kHz)	6.0
Shelf life	The following specifications shall be satisfied when the capacitors are restored to 20°C after exposing them for 1,000 hours at 125°C without voltage applied. Before the measurement, the capacitor shall be preconditioned by applying voltage according to Item 4.1 of JIS C 5101-4.	
	Capacitance change	≤ ±30% of the initial value
	D.F. (tan δ)	≤300% of the initial specified value
	Leakage current	≤The initial specified value

◆ DIMENSIONS [mm]

- Terminal Code : A
- Size code : F80

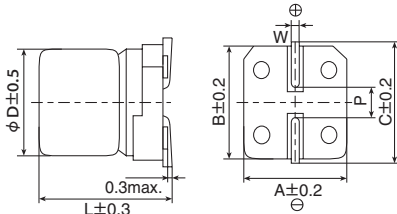

Size code	D	L	A	B	C	W	P
F80	6.3	7.7	6.6	6.6	7.2	0.5 to 0.8	1.9

◆ PART NUMBERING SYSTEM

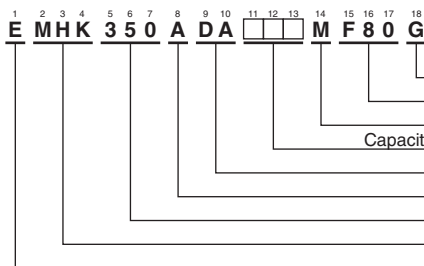

◆ MARKING

EX) 35V47μF



● Rated voltage symbol

Rated voltage (V _{dc})	Symbol
35	V

Please refer to "Product code guide (surface mount type)"

Return Group Chart



SURFACE MOUNT ALUMINUM ELECTROLYTIC CAPACITORS

High heat resistance, 125°C

Alchip™-**MHK** Series

◆STANDARD RATINGS

WV (V _{dc})	Cap (μF)	Size code	ESR (Ω max./100k to 400kHz)		Rated ripple current (mA _{rms} /125°C, 100k to 400kHz)	Part No.
			20°C	-40°C		
35	47	F80	0.30	3.0	240	EMHK350ADA470MF80G
	100	F80	0.30	3.0	240	EMHK350ADA101MF80G

◆RATED RIPPLE CURRENT MULTIPLIERS

⊙Frequency Multipliers

Capacitance(μF) \ Frequency(Hz)	120	1k	10k	100k
47 to 100	0.40	0.75	0.90	1.00

The endurance of capacitors is reduced with internal heating produced by ripple current at the rate of halving the lifetime with every 5°C rise. When long life performance is required in actual use, the rms ripple current has to be reduced.

Return Group Chart



SURFACE MOUNT ALUMINUM ELECTROLYTIC CAPACITORS

Low ESR, 105°C

Alchip™-MKB Series

- Low ESR
- Endurance : 3,000 hours at 105°C
- Rated voltage 400V, Capacitance 2.2 to 4.7μF
- RoHS Compliant



◆ SPECIFICATIONS

Items	Characteristics	
Category	-40 to +105°C	
Temperature Range		
Rated Voltage Range	400V _{dc}	
Capacitance Tolerance	±20%(M) (at 20°C, 120Hz)	
Leakage Current	I=0.04CV+100(max.) Where, I : Max. leakage current (μA), C : Nominal capacitance (μF), V : Rated voltage (V) (at 20°C after 1 minute)	
Dissipation Factor (tan δ)	Rated voltage(V _{dc})	400V
	tan δ (Max.)	0.25 (at 20°C, 120Hz)
Low Temperature Characteristics (Max. impedance Ratio)	Rated voltage(V _{dc})	400V
	Z(-25°C)/Z(+20°C)	6
	Z(-40°C)/Z(+20°C)	10 (at 120Hz)
Endurance	The following specifications shall be satisfied when the capacitors are restored to 20°C after the rated voltage is applied for 3,000 hours at 105°C.	
	Capacitance change	≤ ±20% of the initial value
	D.F. (tan δ)	≤200% of the initial specified value
	Leakage current	≤The initial specified value
Shelf life	The following specifications shall be satisfied when the capacitors are restored to 20°C after exposing them for 500 hours at 105°C without voltage applied. Before the measurement, the capacitor shall be preconditioned by applying voltage according to Item 4.1 of JIS C 5101-4.	
	Capacitance change	≤ ±20% of the initial value
	D.F. (tan δ)	≤200% of the initial specified value
	Leakage current	≤The initial specified value

◆ DIMENSIONS [mm]

- Terminal Code : A

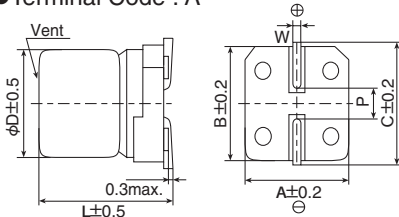

Size code	D	L	A	B	C	W	P
HA0	8	10.0	8.3	8.3	9.0	0.7 to 1.1	3.1
JA0	10	10.0	10.3	10.3	11.0	0.7 to 1.1	4.5

◆ PART NUMBERING SYSTEM

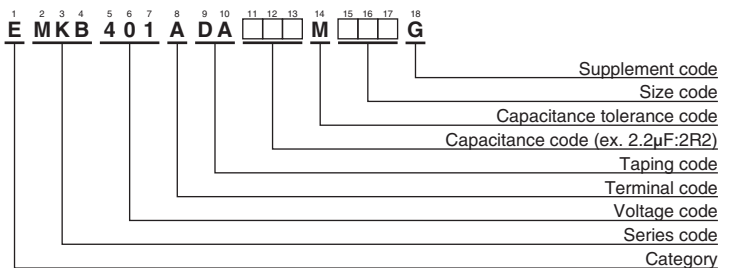

Please refer to "Product code guide (surface mount type)"

◆ MARKING

EX) 400V3.9μF



- Rated voltage symbol

Rated voltage (V _{dc})	Symbol
400	2G

◆ STANDARD RATINGS

WV (V _{dc})	Cap (μF)	Size code	ESR (Ω max./120Hz)		Rated ripple current (mA _{rms} /105°C, 120Hz)	Part No.
			20°C	-40°C		
400	2.2	HA0	20	1,000	26	EMKB401ADA2R2MHA0G
	3.3	JA0	10	500	37	EMKB401ADA3R3MJA0G
	3.9	JA0	10	500	38	EMKB401ADA3R9MJA0G
	4.7	JA0	10	500	39	EMKB401ADA4R7MJA0G

◆ RATED RIPPLE CURRENT MULTIPLIERS

- Frequency Multipliers

Frequency(Hz)	120	1k	10k	100k
400V _{dc}	1.00	1.30	1.40	1.50

The endurance of capacitors is reduced with internal heating produced by ripple current at the rate of halving the lifetime with every 5°C rise. When long life performance is required in actual use, the rms ripple current has to be reduced.

Return Group Chart



SURFACE MOUNT ALUMINUM ELECTROLYTIC CAPACITORS

Bi-polar, 85°C

Alchip™-MV-BP Series



- Bi-polar chip type for the circuit, of which polarity is frequently reversed
- Solvent resistant type (see PRECAUTIONS AND GUIDELINES)
- RoHS Compliant

◆ SPECIFICATIONS

Items	Characteristics						
Category	-40 to +85°C						
Temperature Range	-40 to +85°C						
Rated Voltage Range	6.3 to 50V _{dc}						
Capacitance Tolerance	±20% (M) (at 20°C, 120Hz)						
Leakage Current	I=0.05CV or 10μA, whichever is greater. Where, I : Max. leakage current (μA), C : Nominal capacitance (μF), V : Rated voltage (V) (at 20°C after 2 minutes)						
Dissipation Factor (tan δ)	Rated voltage (V _{dc})	6.3V	10V	16V	25V	35V	50V
	tan δ (Max.)	0.32	0.26	0.24	0.22	0.20	0.20
Low Temperature Characteristics (Max. Impedance Ratio)	Rated voltage (V _{dc})	6.3V	10V	16V	25V	35V	50V
	Z(-25°C)/Z(+20°C)	4	3	2	2	2	2
	Z(-40°C)/Z(+20°C)	10	8	6	4	3	3
Endurance	The following specifications shall be satisfied when the capacitors are restored to 20°C after the rated voltage is applied for 2,000 hours at 85°C, however the polarization shall be reversed every 250 hours.						
	Capacitance change	≤ ±20% of the initial value					
	D.F. (tan δ)	≤ 200% of the initial specified value					
	Leakage current	≤ The initial specified value					
Shelf Life	The following specifications shall be satisfied when the capacitors are restored to 20°C after exposing them for 500 hours at 85°C without voltage applied. Before the measurement, the capacitor shall be preconditioned by applying voltage according to Item 4.1 of JIS C 5101-4.						
	Capacitance change	≤ ± 15% of the initial value					
	D.F. (tan δ)	≤ 150% of the initial specified value					
	Leakage current	≤ The initial specified value					

◆ DIMENSIONS [mm]

● Terminal Code : A

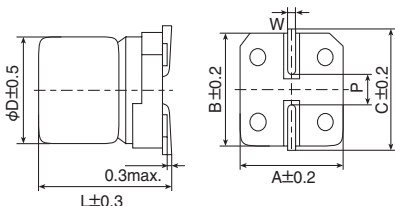

Size code	D	L	A	B	C	W	P
D55	4	5.2	4.3	4.3	5.1	0.5 to 0.8	1.0
E55	5	5.2	5.3	5.3	5.9	0.5 to 0.8	1.4
F55	6.3	5.2	6.6	6.6	7.2	0.5 to 0.8	1.9

◆ PART NUMBERING SYSTEM

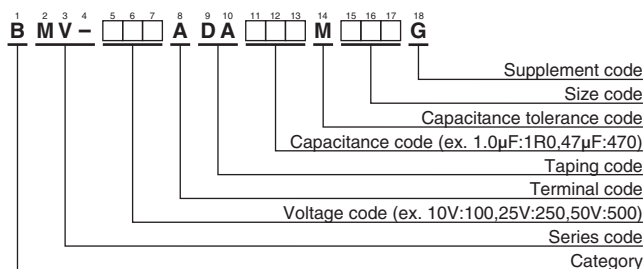

Please refer to "Product code guide (surface mount type)"

◆ MARKING

EX) 35V4.7μF

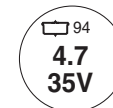

◆ STANDARD RATINGS

WV (V _{dc})	Cap (μF)	Size code	tan δ	Rated ripple current (mArms/85°C, 120Hz)	Part No.
6.3	10	D55	0.32	13	BMV-6R3ADA100MD55G
	22	E55	0.32	23	BMV-6R3ADA220ME55G
	47	F55	0.32	36	BMV-6R3ADA470MF55G
10	33	F55	0.26	33	BMV-100ADA330MF55G
	4.7	D55	0.24	11	BMV-160ADA4R7MD55G
16	10	E55	0.24	18	BMV-160ADA100ME55G
	22	F55	0.24	28	BMV-160ADA220MF55G
	3.3	D55	0.22	9.0	BMV-250ADA3R3MD55G
35	2.2	D55	0.20	8.0	BMV-350ADA2R2MD55G
	4.7	E55	0.20	13	BMV-350ADA4R7ME55G
	10	F55	0.20	21	BMV-350ADA100MF55G
50	1.0	D55	0.20	5.5	BMV-500ADA1R0MD55G
	2.2	E55	0.20	9.0	BMV-500ADA2R2ME55G
	3.3	E55	0.20	11	BMV-500ADA3R3ME55G
	4.7	F55	0.20	14	BMV-500ADA4R7MF55G

◆ RATED RIPPLE CURRENT MULTIPLIERS

● Frequency Multipliers

Capacitance(μF)	Frequency(Hz)	120	1k	10k	100k
1	1.00	1.00	1.50	1.75	1.80
	2.2 to 10	1.00	1.30	1.40	1.50
22 to 47	1.00	1.05	1.08	1.08	

The endurance of capacitors is reduced with internal heating produced by ripple current at the rate of halving the lifetime with every 5°C rise.
When long life performance is required in actual use, the rms ripple current has to be reduced.

Return Group Chart



SURFACE MOUNT ALUMINUM ELECTROLYTIC CAPACITORS

Bi-polar, 105°C

Alchip™-MVK-BP Series



- Bi-polar chip type for the circuit, of which polarity is frequently reversed
- Solvent resistant type (see PRECAUTIONS AND GUIDELINES)
- RoHS Compliant

◆ SPECIFICATIONS

Items	Characteristics						
Category	-40 to +105°C						
Temperature Range	-40 to +105°C						
Rated Voltage Range	6.3 to 50V _{dc}						
Capacitance Tolerance	±20% (M) (at 20°C, 120Hz)						
Leakage Current	I=0.05CV or 10μA, whichever is greater. Where, I : Max. leakage current (μA), C : Nominal capacitance (μF), V : Rated voltage (V) (at 20°C after 2 minutes)						
Dissipation Factor (tan δ)	Rated voltage (V _{dc})	6.3V	10V	16V	25V	35V	50V
	tan δ (Max.)	0.35	0.26	0.24	0.20	0.18	0.18
Low Temperature Characteristics (Max. Impedance Ratio)	Rated voltage (V _{dc})	6.3V	10V	16V	25V	35V	50V
	Z(-25°C)/Z(+20°C)	4	3	2	2	2	2
	Z(-40°C)/Z(+20°C)	10	8	6	4	3	3
Endurance	The following specifications shall be satisfied when the capacitors are restored to 20°C after the rated voltage is applied for 1,000 hours at 105°C, however the polarization shall be reversed every 250 hours.						
	Capacitance change	≤ ±30% of the initial value					
	D.F. (tan δ)	≤ 300% of the initial specified value					
	Leakage current	≤ The initial specified value					
Shelf Life	The following specifications shall be satisfied when the capacitors are restored to 20°C after exposing them for 500 hours at 105°C without voltage applied. Before the measurement, the capacitor shall be preconditioned by applying voltage according to Item 4.1 of JIS C 5101-4.						
	Capacitance change	≤ ±25% of the initial value					
	D.F. (tan δ)	≤ 200% of the initial specified value					
	Leakage current	≤ The initial specified value					

◆ DIMENSIONS [mm]

● Terminal Code : A

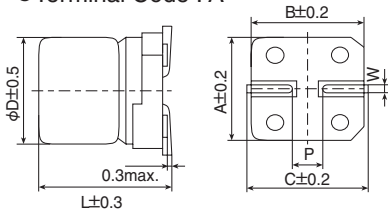

Size code	D	L	A	B	C	W	P
D60	4	5.7	4.3	4.3	5.1	0.5 to 0.8	1.0
E60	5	5.7	5.3	5.3	5.9	0.5 to 0.8	1.4
F60	6.3	5.7	6.6	6.6	7.2	0.5 to 0.8	1.9

◆ PART NUMBERING SYSTEM

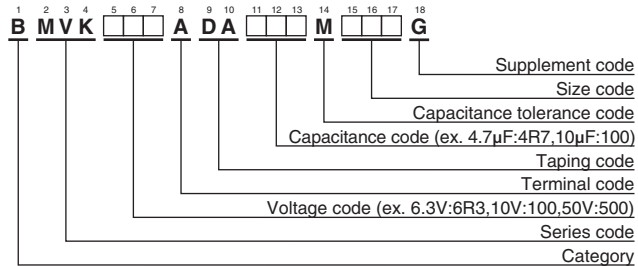

Please refer to "Product code guide (surface mount type)"

◆ MARKING

EX) 35V4.7μF

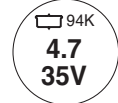

◆ STANDARD RATINGS

WV (V _{dc})	Cap (μF)	Size code	tan δ	Rated ripple current (mA _{rms} /105°C, 120Hz)	Part No.
6.3	10	D60	0.35	14	BMVK6R3ADA100MD60G
	22	E60	0.35	25	BMVK6R3ADA220ME60G
	47	F60	0.35	39	BMVK6R3ADA470MF60G
10	33	F60	0.26	35	BMVK100ADA330MF60G
	4.7	D60	0.24	12	BMVK160ADA4R7MD60G
16	10	E60	0.24	20	BMVK160ADA100ME60G
	22	F60	0.24	32	BMVK160ADA220MF60G
	3.3	D60	0.20	10	BMVK250ADA3R3MD60G
35	2.2	D60	0.18	8.8	BMVK350ADA2R2MD60G
	4.7	E60	0.18	15	BMVK350ADA4R7ME60G
	10	F60	0.18	23	BMVK350ADA100MF60G
50	1.0	D60	0.18	5.5	BMVK500ADA1R0MD60G
	2.2	E60	0.18	10	BMVK500ADA2R2ME60G
	3.3	E60	0.18	13	BMVK500ADA3R3ME60G
	4.7	F60	0.18	16	BMVK500ADA4R7MF60G

◆ RATED RIPPLE CURRENT MULTIPLIERS

● Frequency Multipliers

Capacitance(μF)	Frequency(Hz)	120	1k	10k	100k
1		1.00	1.50	1.75	1.80
2.2 to 10		1.00	1.30	1.40	1.50
22 to 47		1.00	1.05	1.08	1.08

The endurance of capacitors is reduced with internal heating produced by ripple current at the rate of halving the lifetime with every 5°C rise.

When long life performance is required in actual use, the rms ripple current has to be reduced.

NIPPON CHEMI-CON

PART NUMBERING SYSTEM

Product code guide (Radial lead type)

(Example : KMQ series, 450V-100 μ F, ϕ 18 \times 40L, Long lead with bulk)



Please refer to the following table

Contents	Code	Series	Code	Type	Code	Tol.(%)	Code	Sleeve materia	Terminal plating material	Code
Polar	E	KMQ	KMQ	Radial lead	E	± 20	M	PET	Sn-Bi	D
Bi-polar	B	FL	FL-			-10 to +20	V	Sleeveless (Coating case)	Sn	S
									Sn-Bi	G
									Sn	H

1	2	3	4	5	6	7	8	9	10	11	12	13	14	15	16	17	18
E	K	M	Q	4	5	1	E	L	L	1	0	1	M	M	4	0	S
Category	Series code			Voltage code			Terminal code	Lead forming/Taping code		Capacitance code		Capacitance tolerance	Size code		Supplement code		

Voltage(V)	Code
4	4R0
6.3	6R3
10	100
25	250
100	101
250	251
⋮	⋮

Type	Contents	Code
Lead forming (Bulk)	Long Lead	LL
	Cut(3.5mm)	C3
	Cut(5.0mm)	C5
	Forming Cut	FC
	Snap-in ϕ D=5 to 8	FM
	Snap-in ϕ D=10 to 18	MC
Taping	Horizontal	BC
		BD
	Straight	TD
	Gradual forming	
	Straight(Skip a hole)	TE
	Forming(F=2.5mm)	TA
Forming(F=5.0mm)	TC	

Cap.(μ F)	Code
1.0	1R0
4.7	4R7
10	100
47	470
100	101
470	471
1,000	102
⋮	⋮

ϕ D(mm)	Code
4	D
5	E
6.3	F
8	H
10	J
12.5	K
14.5	U
16	L
18	M
20	N
22	P

L(mm)	Code
5	05
7	07
9	09
11	11
11.5	B5
12.5	C5
13	13
15	15
16	16
20	20
25	25
30	30
31.5	N3
35	35
35.5	P1
40	40
45	45
50	50
55	55
60	60

Refer to product guide(P13,14) for lead forming and taping specifications.

*Refer to the appendix (Part number) for codes not listed here.

CUT/FORMED LEAD

<p>Terminal type</p> <p>●Lead code : FC (Forming Cut type) Size : ϕD=4 to 8</p>	<p>Terminal type</p> <p>●Lead code : C3 (Cutting type) Size : ϕD=4 to 18</p> <p>Dimension (C)</p> <ul style="list-style-type: none"> ϕD= 4 to 8: C3: 3.5 ± 0.5 (Second standard C5: 5.0 ± 0.5) ϕD=10 to 18: C3: 3.5 ± 0.5 (Second standard C5: 5.0 ± 0.0) 	<p>Terminal type</p> <p>●Lead code : LJ (Forming Cut type) Size : ϕD=10 to 18</p> <p>Dimension</p> <table border="1" style="width: 100%; border-collapse: collapse; text-align: center;"> <tr> <th>ϕD</th> <th>A-B</th> <th>ϕd</th> <th>P</th> </tr> <tr> <td>10 to 12.5</td> <td>3.2 ± 0.5</td> <td>0.6</td> <td>5.0 ± 0.5</td> </tr> <tr> <td>14.5 to 18</td> <td>3.2 ± 0.5</td> <td>0.8</td> <td>7.5 ± 0.5</td> </tr> </table>	ϕ D	A-B	ϕ d	P	10 to 12.5	3.2 ± 0.5	0.6	5.0 ± 0.5	14.5 to 18	3.2 ± 0.5	0.8	7.5 ± 0.5
ϕ D	A-B	ϕ d	P											
10 to 12.5	3.2 ± 0.5	0.6	5.0 ± 0.5											
14.5 to 18	3.2 ± 0.5	0.8	7.5 ± 0.5											
<p>●Lead code : FM (Snap-in type) Size : ϕD=5 to 8</p>	<p>●Lead code : MC (Snap-in type) Size : ϕD=10 to 18</p>	<p>*1 Please consult with us about other terminal forming. *2 Please refer to dimensions of each series for gas escape end seal. *3 Conventionally, lead forming code is used in common by (BC) for two type of the lead bent directions. We added lead forming code (BD) newly and clarified the lead bent directions. Please place an order after the choice for an appropriate lead forming code depending on condition of use.</p>												
<p>●Lead code : BC (Horizontal type)*3 Size : ϕD=10 to 18</p> <p>Dimension (P)</p> <ul style="list-style-type: none"> ϕ10, ϕ12.5 : P=5.0 ± 0.5 ϕ14.5, ϕ16, ϕ18 : P=7.5 ± 0.5 	<p>●Lead code : BD (Horizontal type)*3 Size : ϕD=10 to 18</p> <p>Dimension (P)</p> <ul style="list-style-type: none"> ϕ10, ϕ12.5 : P=5.0 ± 0.5 ϕ14.5, ϕ16, ϕ18 : P=7.5 ± 0.5 													

Return Group Chart



MINIATURE ALUMINUM ELECTROLYTIC CAPACITORS

Downsized, 5mm height, 85°C

SRM Series

- Downsized from current standard SRE series
- 5mm height
- Endurance : 1,000 hours at 85°C
- Solvent resistant type (see PRECAUTIONS AND GUIDELINES)
- RoHS Compliant

SRM

↑
Downsized
SRE P135



◆ SPECIFICATIONS

Items	Characteristics								
Category Temperature Range	-40 to +85°C								
Rated Voltage Range	4 to 50V _{dc}								
Capacitance Tolerance	±20% (M) (at 20°C, 120Hz)								
Leakage Current	I=0.01CV or 3μA, whichever is greater. Where, I : Max. leakage current (μA), C : Nominal capacitance (μF), V : Rated voltage (V) (at 20°C after 2 minutes)								
Dissipation Factor (tan δ)	Rated voltage (V _{dc})	4V	6.3V	10V	16V	25V	35V	50V	(at 20°C, 120Hz)
	tan δ (Max.)	0.40	0.38	0.30	0.23	0.17	0.15	0.13	
Low Temperature Characteristics (Max. Impedance Ratio)	Rated voltage (V _{dc})	4V	6.3V	10V	16V	25V	35V	50V	(at 120Hz)
	Z(-25°C)/Z(+20°C)	7	4	3	2	2	2	2	
	Z(-40°C)/Z(+20°C)	15	8	8	6	4	3	3	
Endurance	The following specifications shall be satisfied when the capacitors are restored to 20°C after the rated voltage is applied for 1,000 hours at 85°C.								
	Capacitance change	≤ ±20% of the initial value							
	D.F. (tan δ)	≤200% of the initial specified value							
	Leakage current	≤The initial specified value							
Shelf Life	The following specifications shall be satisfied when the capacitors are restored to 20°C after exposing them for 1,000 hours at 85°C without voltage applied. Before the measurement, the capacitor shall be preconditioned by applying voltage according to Item 4.1 of JIS C 5101-4.								
	Capacitance change	≤ ±20% of the initial value							
	D.F. (tan δ)	≤200% of the initial specified value							
	Leakage current	≤The initial specified value							

◆ DIMENSIONS [mm]

● Terminal Code : E

Sleeve (PET : Black)*

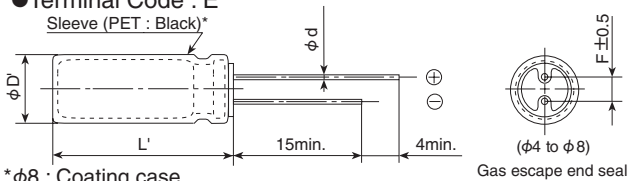

*φ8 : Coating case

φD	4	5	6.3	8
φd	0.45	0.45	0.45	0.45
F	1.5	2.0	2.5	2.5
φD'	φD+0.5max.			
L'	L+1.0max.			

◆ RATED RIPPLE CURRENT MULTIPLIERS

● Frequency Multipliers

Capacitance(μF)	Frequency(Hz)				
	120	300	1k	10k	100k
1	1.00	1.25	1.50	1.75	1.80
2.2 to 10	1.00	1.15	1.30	1.40	1.50
22 to 330	1.00	1.03	1.05	1.08	1.08

The endurance of capacitors is reduced with internal heating produced by ripple current at the rate of halving the lifetime with every 5°C rise. When long life performance is required in actual use, the rms ripple current has to be reduced.

Please refer to "Product code guide (radial lead type)"

◆ PART NUMBERING SYSTEM

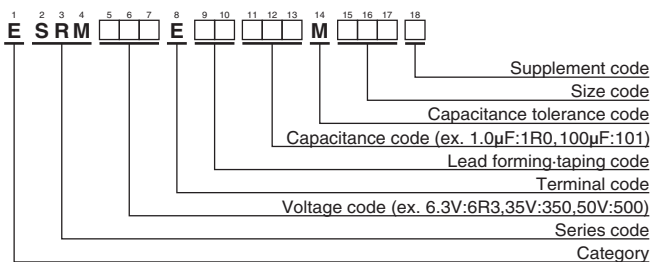

◆ STANDARD RATINGS

WV (V _{dc})	Cap (μF)	Case size φD×L(mm)	tan δ	Rated ripple current (mArms/85°C, 120Hz)	Part No.
4	100	5×5	0.40	55	ESRM4R0E□□101ME05D
	220	6.3×5	0.40	88	ESRM4R0E□□221MF05D
6.3	22	4×5	0.38	22	ESRM6R3E□□220MD05D
	47	4×5	0.38	40	ESRM6R3E□□470MD05D
	330	8×5	0.38	141	ESRM6R3E□□331MH05G
10	33	4×5	0.30	36	ESRM100E□□330MD05D
	100	6.3×5	0.30	78	ESRM100E□□101MF05D
	220	8×5	0.30	148	ESRM100E□□221MH05G
16	10	4×5	0.23	18	ESRM160E□□100MD05D
	22	4×5	0.23	33	ESRM160E□□220MD05D
	33	5×5	0.23	47	ESRM160E□□330ME05D
	47	5×5	0.23	55	ESRM160E□□470ME05D
25	4.7	4×5	0.17	13	ESRM250E□□4R7MD05D
	10	4×5	0.17	25	ESRM250E□□100MD05D
25	22	5×5	0.17	41	ESRM250E□□220ME05D
	47	6.3×5	0.17	63	ESRM250E□□470MF05D
	100	8×5	0.17	116	ESRM250E□□101MH05G
35	3.3	4×5	0.15	12	ESRM350E□□3R3MD05D
	33	6.3×5	0.15	56	ESRM350E□□330MF05D
	47	8×5	0.15	85	ESRM350E□□470MH05G
	1.0	4×5	0.13	7.2	ESRM500E□□1R0MD05D
50	2.2	4×5	0.13	10	ESRM500E□□2R2MD05D
	3.3	4×5	0.13	14	ESRM500E□□3R3MD05D
	4.7	4×5	0.13	19	ESRM500E□□4R7MD05D
	10	5×5	0.13	31	ESRM500E□□100ME05D
	22	6.3×5	0.13	49	ESRM500E□□220MF05D
33	8×5	0.13	76	ESRM500E□□330MH05G	

□□ : Enter the appropriate lead forming or taping code.

Return Group Chart



MINIATURE ALUMINUM ELECTROLYTIC CAPACITORS

5mm height, 85°C

SRE Series

- 5mm height
- Endurance : 1,000 hours at 85°C
- Non solvent resistant type
- RoHS Compliant

SRM P134

Downsized

SRE



◆ SPECIFICATIONS

Items	Characteristics								
Category Temperature Range	-40 to +85°C								
Rated Voltage Range	4 to 50V _{dc}								
Capacitance Tolerance	±20% (M) (at 20°C, 120Hz)								
Leakage Current	I=0.01CV or 3µA, whichever is greater. Where, I : Max. leakage current (µA), C : Nominal capacitance (µF), V : Rated voltage (V) (at 20°C after 2 minutes)								
Dissipation Factor (tan δ)	Rated voltage (V _{dc})	4V	6.3V	10V	16V	25V	35V	50V	(at 20°C, 120Hz)
	tan δ (Max.)	0.35	0.24	0.20	0.16	0.14	0.12	0.10	
Low Temperature Characteristics (Max. Impedance Ratio)	Rated voltage (V _{dc})	4V	6.3V	10V	16V	25V	35V	50V	(at 120Hz)
	Z(-25°C)/Z(+20°C)	7	4	3	2	2	2	2	
	Z(-40°C)/Z(+20°C)	15	10	8	6	4	3	3	
Endurance	The following specifications shall be satisfied when the capacitors are restored to 20°C after the rated voltage is applied for 1,000 hours at 85°C.								
	Capacitance change	≤ ±20% of the initial value							
	D.F. (tan δ)	≤200% of the initial specified value							
	Leakage current	≤The initial specified value							
Shelf Life	The following specifications shall be satisfied when the capacitors are restored to 20°C after exposing them for 1,000 hours at 85°C without voltage applied. Before the measurement, the capacitor shall be preconditioned by applying voltage according to Item 4.1 of JIS C 5101-4.								
	Capacitance change	≤ ±20% of the initial value							
	D.F. (tan δ)	≤200% of the initial specified value							
	Leakage current	≤The initial specified value							

◆ DIMENSIONS [mm]

- Terminal Code : E

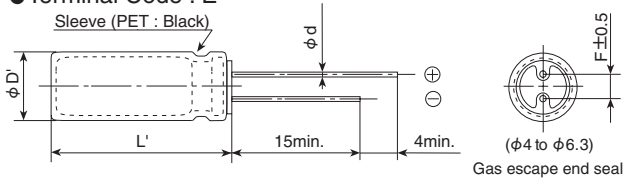

φD	4	5	6.3
φd	0.45	0.45	0.45
F	1.5	2.0	2.5
φD'	φD+0.5max.		
L'	L+1.0max.		

◆ PART NUMBERING SYSTEM

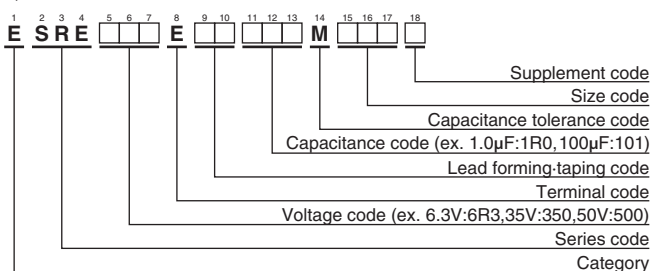

◆ RATED RIPPLE CURRENT MULTIPLIERS

- Frequency Multipliers

Capacitance(µF)	Frequency(Hz)				
	120	300	1k	10k	100k
1	1.00	1.25	1.50	1.75	1.80
2.2 to 10	1.00	1.15	1.30	1.40	1.50
22 to 100	1.00	1.03	1.05	1.08	1.08

The endurance of capacitors is reduced with internal heating produced by ripple current at the rate of halving the lifetime with every 5°C rise.

When long life performance is required in actual use, the rms ripple current has to be reduced.

Please refer to "Product code guide (radial lead type)"

◆ STANDARD RATINGS

WV (V _{dc})	Cap (µF)	Case size φD×L(mm)	tan δ	Rated ripple current (mA _{rms} /85°C, 120Hz)	Part No.
4	33	4 × 5	0.35	23	ESRE4R0E□□330MD05D
	10	4 × 5	0.24	12	ESRE6R3E□□100MD05D
6.3	22	4 × 5	0.24	23	ESRE6R3E□□220MD05D
	47	5 × 5	0.24	38	ESRE6R3E□□470ME05D
	100	6.3 × 5	0.24	60	ESRE6R3E□□101MF05D
10	33	5 × 5	0.20	35	ESRE100E□□330ME05D
	4.7	4 × 5	0.16	10	ESRE160E□□4R7MD05D
16	10	4 × 5	0.16	17	ESRE160E□□100MD05D
	22	5 × 5	0.16	32	ESRE160E□□220ME05D
	47	6.3 × 5	0.16	50	ESRE160E□□470MF05D
25	3.3	4 × 5	0.14	9.3	ESRE250E□□3R3MD05D
	4.7	4 × 5	0.14	12	ESRE250E□□4R7MD05D
	33	6.3 × 5	0.14	45	ESRE250E□□330MF05D

WV (V _{dc})	Cap (µF)	Case size φD×L(mm)	tan δ	Rated ripple current (mA _{rms} /85°C, 120Hz)	Part No.
35	2.2	4 × 5	0.12	8.3	ESRE350E□□2R2MD05D
	3.3	4 × 5	0.12	11	ESRE350E□□3R3MD05D
	4.7	4 × 5	0.12	15	ESRE350E□□4R7MD05D
	10	5 × 5	0.12	25	ESRE350E□□100ME05D
	22	6.3 × 5	0.12	40	ESRE350E□□220MF05D
50	1.0	4 × 5	0.10	6.2	ESRE500E□□1R0MD05D
	2.2	4 × 5	0.10	10	ESRE500E□□2R2MD05D
	3.3	4 × 5	0.10	14	ESRE500E□□3R3MD05D
	4.7	5 × 5	0.10	19	ESRE500E□□4R7ME05D
	10	6.3 × 5	0.10	29	ESRE500E□□100MF05D

□ : Enter the appropriate lead forming or taping code.

Return Group Chart



MINIATURE ALUMINUM ELECTROLYTIC CAPACITORS

5mm height, 105°C

KRE Series

- 5mm height
- Endurance : 1,000 hours at 105°C
- Solvent resistant type (see PRECAUTIONS AND GUIDELINES)
- RoHS Compliant

KRE
↑
105°C
SRE P135



◆ SPECIFICATIONS

Items	Characteristics						
Category Temperature Range	-55 to +105°C						
Rated Voltage Range	6.3 to 50V _{dc}						
Capacitance Tolerance	±20% (M) (at 20°C, 120Hz)						
Leakage Current	I=0.01CV or 3μA, whichever is greater. Where, I : Max. leakage current (μA), C : Nominal capacitance (μF), V : Rated voltage (V) (at 20°C after 2 minutes)						
Dissipation Factor (tan δ)	Rated voltage (V _{dc})	6.3V	10V	16V	25V	35V	50V
	tan δ (Max.)	0.27	0.23	0.19	0.15	0.13	0.11
Low Temperature Characteristics (Max. Impedance Ratio)	Rated voltage (V _{dc})	6.3V	10V	16V	25V	35V	50V
	Z(-25°C)/Z(+20°C)	3	3	2	2	2	2
	Z(-40°C)/Z(+20°C)	9	7	5	3	3	3
Endurance	The following specifications shall be satisfied when the capacitors are restored to 20°C after the rated voltage is applied for 1,000 hours at 105°C.						
	Capacitance change	≤ ±20% of the initial value					
	D.F. (tan δ)	≤ 200% of the initial specified value					
	Leakage current	≤ The initial specified value					
Shelf Life	The following specifications shall be satisfied when the capacitors are restored to 20°C after exposing them for 500 hours at 105°C without voltage applied. Before the measurement, the capacitor shall be preconditioned by applying voltage according to Item 4.1 of JIS C 5101-4.						
	Capacitance change	≤ ±20% of the initial value					
	D.F. (tan δ)	≤ 200% of the initial specified value					
	Leakage current	≤ The initial specified value					

◆ DIMENSIONS [mm]

- Terminal Code : E

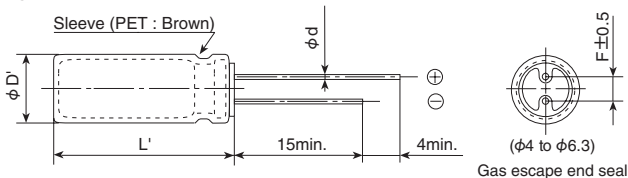

φD	4	5	6.3
φd	0.45	0.45	0.45
F	1.5	2.0	2.5
φD'	φD+0.5max.		
L'	L+1.0max.		

◆ PART NUMBERING SYSTEM

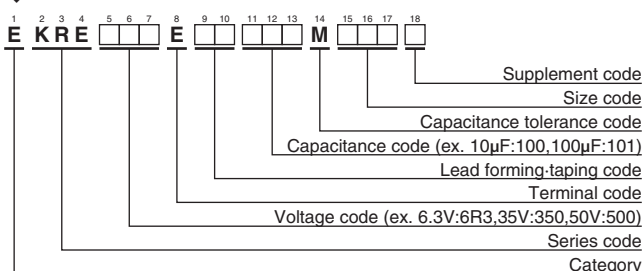

◆ RATED RIPPLE CURRENT MULTIPLIERS

- Frequency Multipliers

Capacitance(μF)	Frequency(Hz)				
	120	300	1k	10k	100k
1	1.00	1.25	1.50	1.75	1.80
2.2 to 10	1.00	1.15	1.30	1.40	1.50
22 to 100	1.00	1.03	1.05	1.08	1.08

The endurance of capacitors is reduced with internal heating produced by ripple current at the rate of halving the lifetime with every 5°C rise.

When long life performance is required in actual use, the rms ripple current has to be reduced.

Please refer to "Product code guide (radial lead type)"

◆ STANDARD RATINGS

WV (V _{dc})	Cap (μF)	Case size φD×L(mm)	tan δ	Rated ripple current (mArms/105°C, 120Hz)	Part No.	WV (V _{dc})	Cap (μF)	Case size φD×L(mm)	tan δ	Rated ripple current (mArms/105°C, 120Hz)	Part No.
6.3	10	4×5	0.27	12	EKRE6R3E□□100MD05D	35	2.2	4×5	0.13	7.7	EKRE350E□□2R2MD05D
	22	4×5	0.27	21	EKRE6R3E□□220MD05D		3.3	4×5	0.13	11	EKRE350E□□3R3MD05D
	47	5×5	0.27	36	EKRE6R3E□□470ME05D		4.7	4×5	0.13	15	EKRE350E□□4R7MD05D
	100	6.3×5	0.27	56	EKRE6R3E□□101MF05D		10	5×5	0.13	25	EKRE350E□□100ME05D
10	33	5×5	0.23	34	EKRE100E□□330ME05D	22	6.3×5	0.13	40	EKRE350E□□220MF05D	
16	4.7	4×5	0.19	9.4	EKRE160E□□4R7MD05D	50	1.0	4×5	0.11	5.6	EKRE500E□□1R0MD05D
	10	4×5	0.19	16	EKRE160E□□100MD05D		2.2	4×5	0.11	10	EKRE500E□□2R2MD05D
	22	5×5	0.19	30	EKRE160E□□220ME05D		3.3	4×5	0.11	14	EKRE500E□□3R3MD05D
	47	6.3×5	0.19	48	EKRE160E□□470MF05D		4.7	5×5	0.11	19	EKRE500E□□4R7ME05D
25	3.3	4×5	0.15	8.8	EKRE250E□□3R3MD05D	10	6.3×5	0.11	29	EKRE500E□□100MF05D	
	4.7	4×5	0.15	12	EKRE250E□□4R7MD05D						
	33	6.3×5	0.15	45	EKRE250E□□330MF05D						

□□ : Enter the appropriate lead forming or taping code.

Return Group Chart



MINIATURE ALUMINUM ELECTROLYTIC CAPACITORS

7mm height, 85°C

SRA Series

- 7mm height
- Endurance : 1,000 hours at 85°C
- Non solvent resistant type
- RoHS Compliant

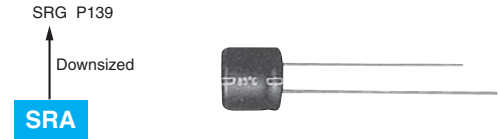

◆ SPECIFICATIONS

Items	Characteristics									
Category	-40 to +85°C									
Temperature Range	-40 to +85°C									
Rated Voltage Range	4 to 63V _{dc}									
Capacitance Tolerance	±20% (M) (at 20°C, 120Hz)									
Leakage Current	I=0.01CV or 3μA, whichever is greater. Where, I : Max. leakage current (μA), C : Nominal capacitance (μF), V : Rated voltage (V) (at 20°C after 2 minutes)									
Dissipation Factor (tan δ)	Rated voltage (V _{dc})	4V	6.3V	10V	16V	25V	35V	50V	63V	(at 20°C, 120Hz)
	tan δ (Max.)	0.35	0.24	0.20	0.16	0.14	0.12	0.10	0.08	
Low Temperature Characteristics (Max. Impedance Ratio)	Rated voltage (V _{dc})	4V	6.3V	10V	16V	25V	35V	50V	63V	(at 120Hz)
	Z(-25°C)/Z(+20°C)	4	4	3	2	2	2	2	2	
	Z(-40°C)/Z(+20°C)	10	10	8	6	4	3	3	3	
Endurance	The following specifications shall be satisfied when the capacitors are restored to 20°C after the rated voltage is applied for 1,000 hours at 85°C.									
	Capacitance change	≤ ±20% of the initial value								
	D.F. (tan δ)	≤200% of the initial specified value								
	Leakage current	≤The initial specified value								
Shelf Life	The following specifications shall be satisfied when the capacitors are restored to 20°C after exposing them for 500 hours at 85°C without voltage applied. Before the measurement, the capacitor shall be preconditioned by applying voltage according to Item 4.1 of JIS C 5101-4.									
	Capacitance change	≤ ±20% of the initial value								
	D.F. (tan δ)	≤200% of the initial specified value								
	Leakage current	≤The initial specified value								

◆ DIMENSIONS [mm]

- Terminal Code : E

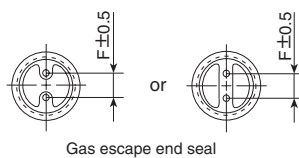
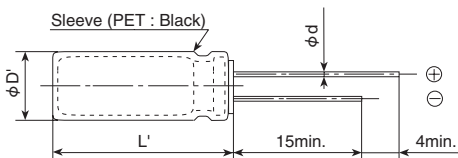

φD	4	5	6.3	8
φd	0.45	0.45	0.45	0.45
F	1.5	2.0	2.5	3.5
φD'	φD+0.5max.			
L'	L+1.0max.			

◆ PART NUMBERING SYSTEM

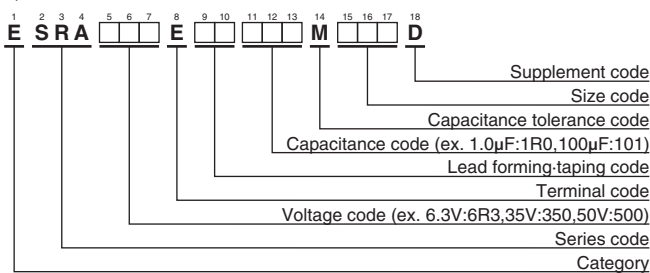

◆ RATED RIPPLE CURRENT MULTIPLIERS

- Frequency Multipliers

Capacitance(μF)	Frequency(Hz)				
	120	300	1k	10k	100k
1	1.00	1.25	1.50	1.75	1.80
2.2 to 10	1.00	1.15	1.30	1.40	1.50
22 to 470	1.00	1.03	1.05	1.08	1.08

The endurance of capacitors is reduced with internal heating produced by ripple current at the rate of halving the lifetime with every 5°C rise.

When long life performance is required in actual use, the rms ripple current has to be reduced.

Please refer to "Product code guide (radial lead type)"

◆ STANDARD RATINGS

WV (V _{dc})	Cap (μF)	Case size φD×L(mm)	tan δ	Rated ripple current (mArms/85°C, 120Hz)	Part No.	WV (V _{dc})	Cap (μF)	Case size φD×L(mm)	tan δ	Rated ripple current (mArms/85°C, 120Hz)	Part No.	
4	33	4×7	0.35	26	ESRA4R0E□□330MD07D	35	4.7	4×7	0.12	20	ESRA350E□□4R7MD07D	
	47	4×7	0.35	34	ESRA4R0E□□470MD07D		10	5×7	0.12	30	ESRA350E□□100ME07D	
	100	5×7	0.35	61	ESRA4R0E□□101ME07D		22	6.3×7	0.12	47	ESRA350E□□220MF07D	
	220	6.3×7	0.35	95	ESRA4R0E□□221MF07D		33	6.3×7	0.12	64	ESRA350E□□330MF07D	
	470	8×7	0.35	154	ESRA4R0E□□471MH07D		47	8×7	0.12	83	ESRA350E□□470MH07D	
6.3	22	4×7	0.24	31	ESRA6R3E□□220MD07D	50	1.0	4×7	0.10	10	ESRA500E□□1R0MD07D	
	47	5×7	0.24	47	ESRA6R3E□□470ME07D		2.2	4×7	0.10	15	ESRA500E□□2R2MD07D	
	330	8×7	0.24	156	ESRA6R3E□□331MH07D		3.3	4×7	0.10	18	ESRA500E□□3R3MD07D	
10	33	5×7	0.20	43	ESRA100E□□330ME07D		4.7	5×7	0.10	23	ESRA500E□□4R7ME07D	
	100	6.3×7	0.20	80	ESRA100E□□101MF07D		10	6.3×7	0.10	34	ESRA500E□□100MF07D	
	220	8×7	0.20	140	ESRA100E□□221MH07D		22	6.3×7	0.10	57	ESRA500E□□220MF07D	
16	10	4×7	0.16	25	ESRA160E□□100MD07D		63	33	8×7	0.10	76	ESRA500E□□330MH07D
	22	5×7	0.16	39	ESRA160E□□220ME07D			1.0	4×7	0.08	11	ESRA630E□□1R0MD07D
	47	6.3×7	0.16	59	ESRA160E□□470MF07D			2.2	4×7	0.08	17	ESRA630E□□2R2MD07D
	100	6.3×7	0.16	97	ESRA160E□□101MF07D			3.3	5×7	0.08	21	ESRA630E□□3R3ME07D
25	33	6.3×7	0.14	53	ESRA250E□□330MF07D	4.7		6.3×7	0.08	26	ESRA630E□□4R7MF07D	
	47	6.3×7	0.14	71	ESRA250E□□470MF07D	10		6.3×7	0.08	47	ESRA630E□□100MF07D	

□□ : Enter the appropriate lead forming or taping code.

Product specifications in this catalog are subject to change without notice. Request our product specifications before purchase and/or use. Please use our products based on the information contained in this catalog and product specifications.

Return Group Chart



MINIATURE ALUMINUM ELECTROLYTIC CAPACITORS

7mm height, 105°C

KMA Series

- 7mm height
- Endurance : 1,000 hours at 105°C
- Solvent resistant type (see PRECAUTIONS AND GUIDELINES)
- RoHS Compliant



105°C
SRA P137



◆ SPECIFICATIONS

Items	Characteristics	
Category	-55 to +105°C	
Temperature Range	-55 to +105°C	
Rated Voltage Range	4 to 63V _{dc}	
Capacitance Tolerance	±20% (M) (at 20°C, 120Hz)	
Leakage Current	I=0.01CV or 3μA, whichever is greater. Where, I : Max. leakage current (μA), C : Nominal capacitance (μF), V : Rated voltage (V) (at 20°C after 2 minutes)	
Dissipation Factor (tan δ)	Rated voltage (V _{dc})	4V 6.3V 10V 16V 25V 35V 50V 63V
	tan δ (Max.)	0.35 0.22 0.19 0.16 0.14 0.12 0.10 0.08 (at 20°C, 120Hz)
Low Temperature Characteristics (Max. Impedance Ratio)	Rated voltage (V _{dc})	4V 6.3V 10V 16V 25V 35V 50V 63V
	Z(-25°C)/Z(+20°C)	4 3 2 2 2 2 2 2
	Z(-40°C)/Z(+20°C)	10 6 5 3 3 3 3 3 (at 120Hz)
Endurance	The following specifications shall be satisfied when the capacitors are restored to 20°C after the rated voltage is applied for 1,000 hours at 105°C.	
	Rated voltage	4 to 16V _{dc} 25 to 63V _{dc}
	Capacitance change	≤ ±25% of the initial value ≤ ±20% of the initial value
	D.F. (tan δ)	≤ 200% of the initial specified value
	Leakage current	≤ The initial specified value
Shelf Life	The following specifications shall be satisfied when the capacitors are restored to 20°C after exposing them for 1,000 hours at 105°C without voltage applied. Before the measurement, the capacitor shall be preconditioned by applying voltage according to Item 4.1 of JIS C 5101-4.	
	Rated voltage	4 to 16V _{dc} 25 to 63V _{dc}
	Capacitance change	≤ ±25% of the initial value ≤ ±20% of the initial value
	D.F. (tan δ)	≤ 200% of the initial specified value
	Leakage current	≤ The initial specified value

◆ DIMENSIONS [mm]

- Terminal Code : E
- Sleeve (PET : Brown)

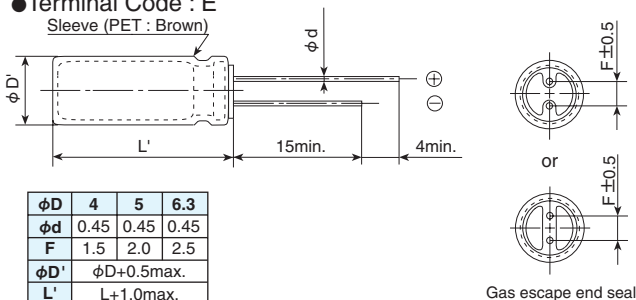

◆ PART NUMBERING SYSTEM

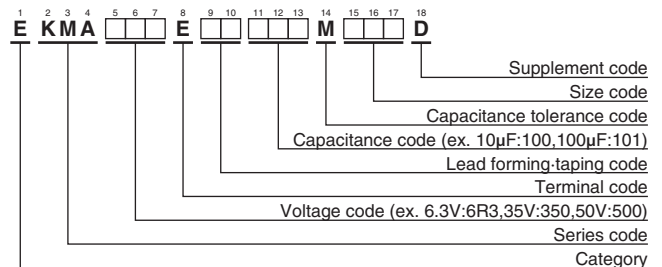

Please refer to "Product code guide (radial lead type)"

◆ STANDARD RATINGS

WV (V _{dc})	Cap (μF)	Case size φD×L(mm)	tan δ	Rated ripple current (mA _{rms} /105°C, 120Hz)	Part No.	WV (V _{dc})	Cap (μF)	Case size φD×L(mm)	tan δ	Rated ripple current (mA _{rms} /105°C, 120Hz)	Part No.
4	33	4 × 7	0.35	26	EKMA4R0E□□330MD07D	35	4.7	4 × 7	0.12	20	EKMA350E□□4R7MD07D
	47	4 × 7	0.35	34	EKMA4R0E□□470MD07D		10	5 × 7	0.12	30	EKMA350E□□100ME07D
	100	5 × 7	0.35	61	EKMA4R0E□□101ME07D		22	6.3 × 7	0.12	47	EKMA350E□□220MF07D
	220	6.3 × 7	0.35	95	EKMA4R0E□□221MF07D		33	6.3 × 7	0.12	64	EKMA350E□□330MF07D
6.3	22	4 × 7	0.22	31	EKMA6R3E□□220MD07D	50	1.0	4 × 7	0.10	10	EKMA500E□□1R0MD07D
	47	5 × 7	0.22	47	EKMA6R3E□□470ME07D		2.2	4 × 7	0.10	15	EKMA500E□□2R2MD07D
10	33	5 × 7	0.19	43	EKMA100E□□330ME07D		3.3	4 × 7	0.10	18	EKMA500E□□3R3MD07D
	100	6.3 × 7	0.19	80	EKMA100E□□101MF07D		4.7	5 × 7	0.10	23	EKMA500E□□4R7ME07D
16	10	4 × 7	0.16	25	EKMA160E□□100MD07D		10	6.3 × 7	0.10	34	EKMA500E□□100MF07D
	22	5 × 7	0.16	39	EKMA160E□□220ME07D		22	6.3 × 7	0.10	57	EKMA500E□□220MF07D
	47	6.3 × 7	0.16	59	EKMA160E□□470MF07D	63	1.0	4 × 7	0.08	11	EKMA630E□□1R0MD07D
100	6.3 × 7	0.16	97	EKMA160E□□101MF07D	2.2		4 × 7	0.08	17	EKMA630E□□2R2MD07D	
25	33	6.3 × 7	0.14	53	EKMA250E□□330MF07D		3.3	5 × 7	0.08	21	EKMA630E□□3R3ME07D
	47	6.3 × 7	0.14	71	EKMA250E□□470MF07D		4.7	6.3 × 7	0.08	26	EKMA630E□□4R7MF07D
						10	6.3 × 7	0.08	43	EKMA630E□□100MF07D	

□□ : Enter the appropriate lead forming or taping code.

◆ RATED RIPPLE CURRENT MULTIPLIERS

- Frequency Multipliers

Capacitance(μF)	Frequency(Hz)				
	120	300	1k	10k	100k
1	1.00	1.25	1.50	1.75	1.80
2.2 to 10	1.00	1.15	1.30	1.40	1.50
22 to 220	1.00	1.03	1.05	1.08	1.08

The endurance of capacitors is reduced with internal heating produced by ripple current at the rate of halving the lifetime with every 5°C rise. When long life performance is required in actual use, the rms ripple current has to be reduced.

Return Group Chart



MINIATURE ALUMINUM ELECTROLYTIC CAPACITORS

Low profile, 85°C

SRG Series

- Low profile : $\phi 4 \times 7\text{mm}$ to $\phi 18 \times 25\text{mm}$
- Endurance : 1,000 to 2,000 hours at 85°C
- Solvent resistant type (see PRECAUTIONS AND GUIDELINES)
- RoHS Compliant

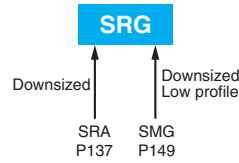

◆ SPECIFICATIONS

Items	Characteristics							
Category	-40 to +85°C							
Temperature Range	-40 to +85°C							
Rated Voltage Range	4 to 50V _{dc}							
Capacitance Tolerance	±20% (M) (at 20°C, 120Hz)							
Leakage Current	I=0.01CV or 3μA, whichever is greater. Where, I : Max. leakage current (μA), C : Nominal capacitance (μF), V : Rated voltage (V) (at 20°C after 2 minutes)							
Dissipation Factor (tan δ)	Rated voltage (V _{dc})	4V	6.3V	10V	16V	25V	35V	50V
	tan δ (Max.)	0.38	0.28	0.24	0.20	0.16	0.14	0.12
	When nominal capacitance exceeds 1,000μF, add 0.03 to the value above for each 1,000μF increase. (at 20°C, 120Hz)							
Low Temperature Characteristics (Max. Impedance Ratio)	Rated voltage (V _{dc})	4V	6.3V	10V	16V	25V	35V	50V
	Z(-25°C)/Z(+20°C)	6	5	4	3	2	2	2
	Z(-40°C)/Z(+20°C)	12	12	10	8	5	4	3
Endurance	The following specifications shall be satisfied when the capacitors are restored to 20°C after the rated voltage is applied for 2,000 hours (1,000 hours for $\phi 8$ and smaller) at 85°C.							
	Capacitance change	≤ ±20% of the initial value						
	D.F. (tan δ)	≤ 200% of the initial specified value						
	Leakage current	≤ The initial specified value						
Shelf Life	The following specifications shall be satisfied when the capacitors are restored to 20°C after exposing them for 1,000 hours at 85°C without voltage applied. Before the measurement, the capacitor shall be preconditioned by applying voltage according to Item 4.1 of JIS C 5101-4.							
	Capacitance change	≤ ±20% of the initial value						
	D.F. (tan δ)	≤ 200% of the initial specified value						
	Leakage current	≤ The initial specified value						

◆ DIMENSIONS [mm]

● Terminal Code : E

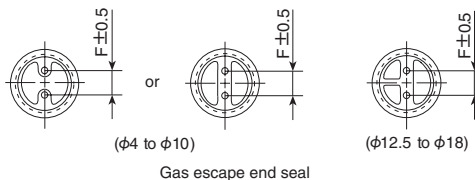
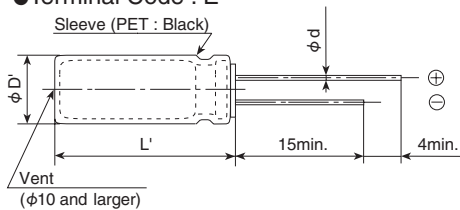

φD	4	5	6.3	8	10 & 12.5	16 & 18
φd	7L	0.45	0.45	0.45	—	—
φd	≥9L	—	0.5	0.5	0.6	0.8
F	1.5	2.0	2.5	3.5	5.0	7.5
φD'	φD+0.5max.					
L'	L+1.5max. (7L : L+1.0max.)					

◆ PART NUMBERING SYSTEM

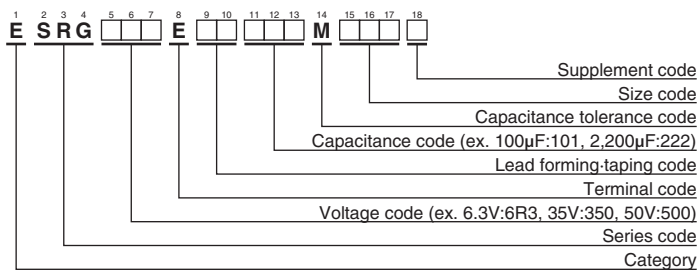

Please refer to "Product code guide (radial lead type)"

Return Group Chart



MINIATURE ALUMINUM ELECTROLYTIC CAPACITORS

Low profile, 85°C

SRG Series

◆ STANDARD RATINGS

WV (V _{dc})	Cap (μF)	Case code φD×L(mm)	tan δ	Rated ripple current (mA _{rms} /85°C, 120Hz)	Part No.	WV (V _{dc})	Cap (μF)	Case code φD×L(mm)	tan δ	Rated ripple current (mA _{rms} /85°C, 120Hz)	Part No.	
4	470	8 × 7	0.38	154	ESRG4R0E□□471MH07D	25	470	10 × 12.5	0.16	525	ESRG250E□□471MJC5S	
	47	4 × 7	0.28	50	ESRG6R3E□□470MD07D		1,000	12.5 × 15	0.16	830	ESRG250E□□102MK15S	
	100	5 × 7	0.28	87	ESRG6R3E□□101ME07D		2,200	18 × 15	0.19	1,360	ESRG250E□□222MM15S	
	220	6.3 × 7	0.28	133	ESRG6R3E□□221MF07D		3,300	18 × 20	0.22	1,720	ESRG250E□□332MM20S	
	330	6.3 × 9	0.28	247	ESRG6R3E□□331MF09D		4,700	18 × 25	0.25	2,070	ESRG250E□□472MM25S	
	330	8 × 7	0.28	191	ESRG6R3E□□331MH07D		35	10	4 × 7	0.14	32	ESRG350E□□100MD07D
	1,000	10 × 9	0.28	505	ESRG6R3E□□102MJ09S			22	5 × 7	0.14	57	ESRG350E□□101ME07D
	4,700	16 × 15	0.37	1,410	ESRG6R3E□□472ML15S			33	5 × 9	0.14	94	ESRG350E□□330ME09D
	6,800	18 × 15	0.43	1,660	ESRG6R3E□□682MM15S			33	6.3 × 7	0.14	73	ESRG350E□□330MF07D
	10,000	18 × 20	0.55	2,020	ESRG6R3E□□103MM20S			47	8 × 7	0.14	101	ESRG350E□□470MH07D
33	4 × 7	0.24	46	ESRG100E□□330MD07D	100	8 × 9		0.14	220	ESRG350E□□101MH09D		
100	5 × 9	0.24	132	ESRG100E□□101ME09D	220	10 × 9		0.14	335	ESRG350E□□221MJ09S		
220	6.3 × 9	0.24	218	ESRG100E□□221MF09D	330	10 × 12.5		0.14	475	ESRG350E□□331MJC5S		
220	8 × 7	0.24	171	ESRG100E□□221MH07D	470	12.5 × 13		0.14	585	ESRG350E□□471MK13S		
470	8 × 9	0.24	385	ESRG100E□□471MH09D	1,000	16 × 15		0.14	1,010	ESRG350E□□102ML15S		
1,000	10 × 12.5	0.24	625	ESRG100E□□102MJC5S	2,200	18 × 20	0.17	1,560	ESRG350E□□222MM20S			
2,200	12.5 × 15	0.27	970	ESRG100E□□222MK15S	50	1.0	4 × 7	0.12	10	ESRG500E□□1R0MD07D		
3,300	16 × 15	0.30	1,310	ESRG100E□□332ML15S		1.0	5 × 9	0.12	13	ESRG500E□□1R0ME09D		
4,700	18 × 15	0.33	1,560	ESRG100E□□472MM15S		2.2	4 × 7	0.12	15	ESRG500E□□2R2MD07D		
6,800	18 × 20	0.39	1,870	ESRG100E□□682MM20S		2.2	5 × 9	0.12	26	ESRG500E□□2R2ME09D		
10,000	18 × 25	0.51	2,370	ESRG100E□□103MM25S		3.3	4 × 7	0.12	19	ESRG500E□□3R3MD07D		
22	4 × 7	0.20	42	ESRG160E□□220MD07D		3.3	5 × 9	0.12	32	ESRG500E□□3R3ME09D		
47	5 × 7	0.20	73	ESRG160E□□470MD07D		4.7	4 × 7	0.12	24	ESRG500E□□4R7MD07D		
100	6.3 × 7	0.20	110	ESRG160E□□101MF07D		4.7	5 × 9	0.12	38	ESRG500E□□4R7ME09D		
220	8 × 9	0.20	290	ESRG160E□□221MH09D		10	5 × 7	0.12	42	ESRG500E□□100ME07D		
330	8 × 9	0.20	355	ESRG160E□□331MH09D		10	5 × 9	0.12	64	ESRG500E□□100ME09D		
470	10 × 9	0.20	410	ESRG160E□□471MJ09S	22	5 × 9	0.12	86	ESRG500E□□220ME09D			
1,000	12.5 × 13	0.20	715	ESRG160E□□102MK13S	22	6.3 × 7	0.12	64	ESRG500E□□220MF07D			
2,200	16 × 15	0.23	1,160	ESRG160E□□222ML15S	33	6.3 × 9	0.12	113	ESRG500E□□330MF09D			
3,300	18 × 15	0.26	1,460	ESRG160E□□332MM15S	33	8 × 7	0.12	93	ESRG500E□□330MH07D			
4,700	18 × 20	0.29	1,770	ESRG160E□□472MM20S	47	6.3 × 9	0.12	135	ESRG500E□□470MF09D			
6,800	18 × 25	0.35	2,170	ESRG160E□□682MM25S	100	10 × 9	0.12	240	ESRG500E□□101MJ09S			
33	5 × 7	0.16	66	ESRG250E□□330ME07D	220	10 × 12.5	0.12	415	ESRG500E□□221MJC5S			
47	5 × 9	0.16	105	ESRG250E□□470ME09D	330	12.5 × 13	0.12	525	ESRG500E□□331MK13S			
47	6.3 × 7	0.16	80	ESRG250E□□470MF07D	470	16 × 15	0.12	745	ESRG500E□□471ML15S			
100	6.3 × 9	0.16	172	ESRG250E□□101MF09D	1,000	18 × 20	0.12	1,160	ESRG500E□□102MM20S			
330	10 × 9	0.16	380	ESRG250E□□331MJ09S								

□□ : Enter the appropriate lead forming or taping code.

◆ RATED RIPPLE CURRENT MULTIPLIERS

● Frequency Multipliers

Capacitance(μF)	Frequency(Hz)					
	50	120	300	1k	10k	100k
to 4.7	0.65	1.00	1.35	1.75	2.30	2.50
10 to 47	0.75	1.00	1.25	1.50	1.75	1.80
100 to 1,000	0.80	1.00	1.15	1.30	1.40	1.50
2,200 to	0.85	1.00	1.03	1.05	1.08	1.08

The endurance of capacitors is reduced with internal heating produced by ripple current at the rate of halving the lifetime with every 5°C rise. When long life performance is required in actual use, the rms ripple current has to be reduced.

Return Group Chart



MINIATURE ALUMINUM ELECTROLYTIC CAPACITORS

Low profile, 105°C

KRG Series

- Low profile : $\phi 4 \times 7\text{mm}$ to $\phi 18 \times 25\text{mm}$
- Endurance : 1,000 hours at 105°C
- Solvent resistant type (see PRECAUTIONS AND GUIDELINES)
- RoHS Compliant

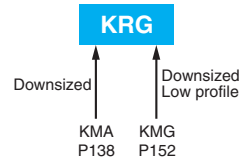

SPECIFICATIONS

Items	Characteristics						
Category	-55 to +105°C						
Temperature Range	-55 to +105°C						
Rated Voltage Range	6.3 to 50V _{dc}						
Capacitance Tolerance	±20% (M) (at 20°C, 120Hz)						
Leakage Current	I=0.01CV or 3μA, whichever is greater. Where, I : Max. leakage current (μA), C : Nominal capacitance (μF), V : Rated voltage (V) (at 20°C after 2 minutes)						
Dissipation Factor (tan δ)	Rated voltage (V _{dc})	6.3V	10V	16V	25V	35V	50V
	tan δ (Max.)	0.28	0.24	0.20	0.16	0.14	0.12
	When nominal capacitance exceeds 1,000μF, add 0.03 to the value above for each 1,000μF increase. (at 20°C, 120Hz)						
Low Temperature Characteristics (Max. Impedance Ratio)	Rated voltage (V _{dc})	6.3V	10V	16V	25V	35V	50V
	Z(-25°C)/Z(+20°C)	5	4	3	2	2	2
	Z(-40°C)/Z(+20°C)	10	8	6	4	3	3
(at 120Hz)							
Endurance	The following specifications shall be satisfied when the capacitors are restored to 20°C after the rated voltage is applied for 1,000 hours at 105°C.						
	Rated voltage	6.3 to 16V _{dc}			25 to 50V _{dc}		
	Capacitance change	≤ ±25% of the initial value			≤ ±20% of the initial value		
	D.F. (tan δ)	≤200% of the initial specified value			≤200% of the initial specified value		
	Leakage current	≤ The initial specified value			≤ The initial specified value		
Shelf Life	The following specifications shall be satisfied when the capacitors are restored to 20°C after exposing them for 500 hours at 105°C without voltage applied. Before the measurement, the capacitor shall be preconditioned by applying voltage according to Item 4.1 of JIS C 5101-4.						
	Rated voltage	6.3 to 16V _{dc}			25 to 50V _{dc}		
	Capacitance change	≤ ±25% of the initial value			≤ ±20% of the initial value		
	D.F. (tan δ)	≤200% of the initial specified value			≤200% of the initial specified value		
	Leakage current	≤ The initial specified value			≤ The initial specified value		

DIMENSIONS [mm]

● Terminal Code : E

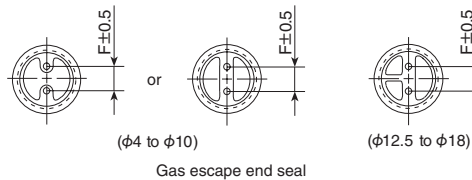
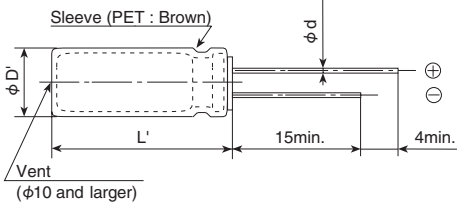

φD	4	5	6.3	8	10 & 12.5	16 & 18
7L	0.45	0.45	0.45	-	-	-
φd	≥9L	-	0.5	0.5	0.6	0.8
F	1.5	2.0	2.5	3.5	5.0	7.5
φD'	φD+0.5max.					
L'	L+1.5max. (7L : L+1.0max.)					

PART NUMBERING SYSTEM

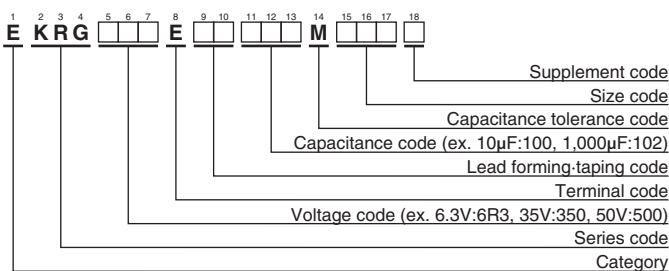

Please refer to "Product code guide (radial lead type)"

Return Group Chart



MINIATURE ALUMINUM ELECTROLYTIC CAPACITORS

Low profile, 105°C

KRG Series

◆STANDARD RATINGS

WV (V _{dc})	Cap (μF)	Case size φD×L(mm)	tan δ	Rated ripple current (mA _{rms} /105°C, 120Hz)	Part No.	WV (V _{dc})	Cap (μF)	Case size φD×L(mm)	tan δ	Rated ripple current (mA _{rms} /105°C, 120Hz)	Part No.
6.3	47	5 × 7	0.28	50	EKRG6R3E□□470ME07D	25	470	10 × 12.5	0.16	370	EKRG250E□□471MJC5S
	330	6.3 × 9	0.28	175	EKRG6R3E□□331MF09D		1,000	12.5 × 15	0.16	590	EKRG250E□□102MK15S
	1,000	10 × 9	0.28	365	EKRG6R3E□□102MJ09S		2,200	18 × 15	0.19	970	EKRG250E□□222MM15S
	4,700	16 × 15	0.37	1,010	EKRG6R3E□□472ML15S		3,300	18 × 20	0.22	1,220	EKRG250E□□332MM20S
	6,800	18 × 15	0.43	1,190	EKRG6R3E□□682MM15S		4,700	18 × 25	0.25	1,470	EKRG250E□□472MM25S
	10,000	18 × 20	0.55	1,440	EKRG6R3E□□103MM20S		35	10	5 × 7	0.14	36
10	22	4 × 7	0.24	35	EKRG100E□□220MD07D	22		6.3 × 7	0.14	57	EKRG350E□□220MF07D
	100	5 × 9	0.24	93	EKRG100E□□101ME09D	33		5 × 9	0.14	67	EKRG350E□□330ME09D
	100	6.3 × 7	0.24	80	EKRG100E□□101MF07D	33		6.3 × 7	0.14	64	EKRG350E□□330MF07D
	220	6.3 × 9	0.24	154	EKRG100E□□221MF09D	100		8 × 9	0.14	155	EKRG350E□□101MH09D
	470	8 × 9	0.24	272	EKRG100E□□471MH09D	220		10 × 9	0.14	235	EKRG350E□□221MJ09S
	1,000	10 × 12.5	0.24	445	EKRG100E□□102MJC5S	330		10 × 12.5	0.14	340	EKRG350E□□331MJC5S
	2,200	12.5 × 15	0.27	690	EKRG100E□□222MK15S	470		12.5 × 13	0.14	415	EKRG350E□□471MK13S
	3,300	16 × 15	0.30	940	EKRG100E□□332ML15S	1,000		16 × 15	0.14	720	EKRG350E□□102ML15S
	4,700	18 × 15	0.33	1,120	EKRG100E□□472MM15S	2,200		18 × 20	0.17	1,110	EKRG350E□□222MM20S
	6,800	18 × 20	0.39	1,330	EKRG100E□□682MM20S	50		1.0	4 × 7	0.12	10
10,000	18 × 25	0.51	1,700	EKRG100E□□103MM25S	1.0			5 × 9	0.12	12	EKRG500E□□1R0ME09D
16	33	5 × 7	0.20	53	EKRG160E□□330ME07D		2.2	4 × 7	0.12	15	EKRG500E□□2R2MD07D
	47	6.3 × 7	0.20	68	EKRG160E□□470MF07D		2.2	5 × 9	0.12	18	EKRG500E□□2R2ME09D
	100	6.3 × 7	0.20	97	EKRG160E□□101MF07D		3.3	4 × 7	0.12	18	EKRG500E□□3R3MD07D
	220	8 × 9	0.20	205	EKRG160E□□221MH09D		3.3	5 × 9	0.12	22	EKRG500E□□3R3ME09D
	330	8 × 9	0.20	251	EKRG160E□□331MH09D		4.7	4 × 7	0.12	25	EKRG500E□□4R7MD07D
	470	10 × 9	0.20	290	EKRG160E□□471MJ09S		4.7	5 × 9	0.12	27	EKRG500E□□4R7ME09D
	1,000	12.5 × 13	0.20	515	EKRG160E□□102MK13S		10	5 × 9	0.12	46	EKRG500E□□100ME09D
	2,200	16 × 15	0.23	830	EKRG160E□□222ML15S		10	6.3 × 7	0.12	44	EKRG500E□□100MF07D
	3,300	18 × 15	0.26	1,050	EKRG160E□□332MM15S		22	5 × 9	0.12	61	EKRG500E□□220ME09D
	4,700	18 × 20	0.29	1,260	EKRG160E□□472MM20S		22	6.3 × 7	0.12	57	EKRG500E□□220MF07D
6,800	18 × 25	0.35	1,560	EKRG160E□□682MM25S	33		6.3 × 9	0.12	80	EKRG500E□□330MF09D	
25	10	4 × 7	0.16	30	EKRG250E□□100MD07D		47	6.3 × 9	0.12	95	EKRG500E□□470MF09D
	22	5 × 7	0.16	46	EKRG250E□□220ME07D		100	10 × 9	0.12	170	EKRG500E□□101MJ09S
	33	6.3 × 7	0.16	63	EKRG250E□□330MF07D		220	10 × 12.5	0.12	290	EKRG500E□□221MJC5S
	47	5 × 9	0.16	75	EKRG250E□□470ME09D		330	12.5 × 13	0.12	370	EKRG500E□□331MK13S
	47	6.3 × 7	0.16	71	EKRG250E□□470MF07D		470	16 × 15	0.12	535	EKRG500E□□471ML15S
	100	6.3 × 9	0.16	121	EKRG250E□□101MF09D	1,000	18 × 20	0.12	830	EKRG500E□□102MM20S	
	330	10 × 9	0.16	270	EKRG250E□□331MJ09S						

□□ : Enter the appropriate lead forming or taping code.

◆RATED RIPPLE CURRENT MULTIPLIERS

● Frequency Multipliers

Capacitance(μF)	Frequency(Hz)					
	50	120	300	1k	10k	100k
to 4.7	0.65	1.00	1.35	1.75	2.30	2.50
10 to 47	0.75	1.00	1.25	1.50	1.75	1.80
100 to 1,000	0.80	1.00	1.15	1.30	1.40	1.50
2,200 to	0.85	1.00	1.03	1.05	1.08	1.08

The endurance of capacitors is reduced with internal heating produced by ripple current at the rate of halving the lifetime with every 5°C rise. When long life performance is required in actual use, the rms ripple current has to be reduced.

Return Group Chart



MINIATURE ALUMINUM ELECTROLYTIC CAPACITORS

Downsized, 85°C

SMQ Series

- Downsized from current standard SMG series
- Endurance : 2,000 hours at 85°C
- Non solvent resistant type
- RoHS Compliant

SMQ

↓ Downsized
SMG P149



◆ SPECIFICATIONS

Items	Characteristics														
Category	-40 to +85°C(6.3 to 400V _{dc}) -25 to +85°C(450V _{dc})														
Temperature Range															
Rated Voltage Range	6.3 to 450V _{dc}														
Capacitance Tolerance	±20% (M) (at 20°C, 120Hz)														
Leakage Current	6.3 to 100V _{dc}							160 to 450V _{dc}							
	I=0.03CV or 4μA, whichever is greater.														
								CV≤1,000		I=0.1CV+40 max.					
							CV>1,000		I=0.04CV+100 max.						
Where, I : Max. leakage current (μA), C : Nominal capacitance (μF), V : Rated voltage (V) (at 20°C after 1 minute)															
Dissipation Factor (tan δ)	Rated voltage (V _{dc})	6.3V	10V	16V	25V	35V	50V	63V	100V	160 to 250V	315 to 400V	450V			
	tan δ (Max.)	0.28	0.24	0.20	0.16	0.14	0.12	0.09	0.08	0.20	0.24	0.24			
	When nominal capacitance exceeds 1,000μF, add 0.02 to the value above for each 1,000μF increase. (at 20°C, 120Hz)														
Low Temperature Characteristics (Max. Impedance Ratio)	Rated voltage (V _{dc})	6.3V	10V	16V	25V	35V	50V	63V	100V	160 to 200V	250V	350V	400V	450V	
	Z(-25°C)/Z(+20°C)	≤φ8	5	4	3	2	2	2	2	2	3	3	4	4	6
		≥φ10	5	4	3	2	2	2	2	2	3	3	4	4	6
	Z(-40°C)/Z(+20°C)	≤φ8	12	10	8	5	4	3	3	3	8	10	8	8	—
	≥φ10	12	10	8	5	4	3	3	3	4	4	6	6	—	
(at 120Hz)															
Endurance	The following specifications shall be satisfied when the capacitors are restored to 20°C after the rated voltage is applied for 2,000 hours at 85°C.														
	Capacitance change	≤ ±20% of the initial value													
	D.F. (tan δ)	≤200% of the initial specified value													
	Leakage current	≤The initial specified value													
Shelf Life	The following specifications shall be satisfied when the capacitors are restored to 20°C after exposing them for 1,000 hours at 85°C without voltage applied. Before the measurement, the capacitor shall be preconditioned by applying voltage according to Item 4.1 of JIS C 5101-4.														
	Rated voltage	6.3 to 100V _{dc}							160 to 450V _{dc}						
	Capacitance change	≤ ±20% of the initial value							≤ ±20% of the initial value						
	D.F. (tan δ)	≤200% of the initial specified value							≤200% of the initial specified value						
	Leakage current	≤The initial specified value							≤500% of the initial specified value						

◆ DIMENSIONS [mm]

- Terminal Code : E

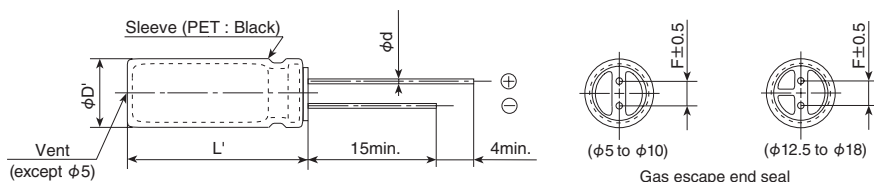

φD	5	6.3	8	10	12.5	16	18
φd	0.5	0.5	0.6	0.6	0.6	0.8	0.8
F	2.0	2.5	3.5	5.0	5.0	7.5	7.5
φD'	φD+0.5max.						
L'	L+1.5max.						

◆ PART NUMBERING SYSTEM

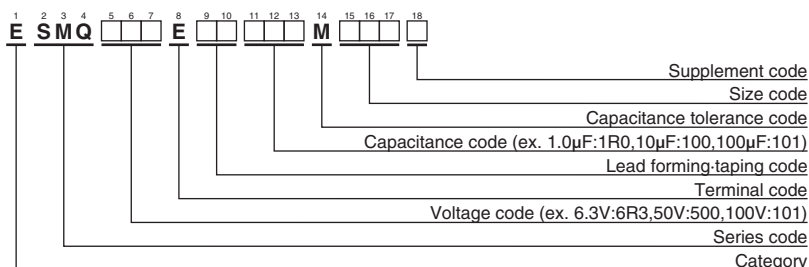

Please refer to "Product code guide (radial lead type)"

Return Group Chart



MINIATURE ALUMINUM ELECTROLYTIC CAPACITORS

Downsized, 85°C

SMQSeries

◆STANDARD RATINGS

WV (V _{dc})	Cap (μF)	Case size φD×L(mm)	tan δ	Rated ripple current (mA _{rms} /85°C, 120Hz)	Part No.	WV (V _{dc})	Cap (μF)	Case size φD×L(mm)	tan δ	Rated ripple current (mA _{rms} /85°C, 120Hz)	Part No.
400	22	12.5 × 25	0.24	205	ESMQ401E□□220MK25S	450	4.7	10 × 12.5	0.24	46	ESMQ451E□□4R7MJC5S
	33	16 × 25	0.24	275	ESMQ401E□□330ML25S		10	10 × 20	0.24	80	ESMQ451E□□100MJ20S
	47	16 × 25	0.24	280	ESMQ401E□□470ML25S		22	12.5 × 25	0.24	140	ESMQ451E□□220MK25S
	68	16 × 31.5	0.24	340	ESMQ401E□□680MLN3S		33	16 × 25	0.24	180	ESMQ451E□□330ML25S
	100	18 × 35.5	0.24	440	ESMQ401E□□101MMP1S		47	16 × 31.5	0.24	220	ESMQ451E□□470MLN3S
450	2.2	8 × 11.5	0.24	28	ESMQ451E□□2R2MHB5D		68	18 × 35.5	0.24	260	ESMQ451E□□680MMP1S
	3.3	10 × 12.5	0.24	40	ESMQ451E□□3R3MJC5S		100	18 × 40	0.24	280	ESMQ451E□□101MM40S

□□ : Enter the appropriate lead forming or taping code.

◆RATED RIPPLE CURRENT MULTIPLIERS

● Frequency Multipliers

Capacitance(μF)	Frequency(Hz)	50	120	300	1k	10k	100k
1.0 to 4.7		0.65	1.00	1.35	1.75	2.30	2.50
10 to 68		0.75	1.00	1.25	1.50	1.75	1.80
100 to 1,000		0.80	1.00	1.15	1.30	1.40	1.50
2,200 to		0.85	1.00	1.03	1.05	1.08	1.08

The endurance of capacitors is reduced with internal heating produced by ripple current at the rate of halving the lifetime with every 5°C rise. When long life performance is required in actual use, the rms ripple current has to be reduced.

Return Group Chart



MINIATURE ALUMINUM ELECTROLYTIC CAPACITORS

Downsized, 105°C

KMQ Series

- Downsized from current standard KMG series
- Solvent resistant type except 160 to 450V_{dc}
(see PRECAUTIONS AND GUIDELINES)
- RoHS Compliant

KMQ

↑ Downsized
KMG P152



SPECIFICATIONS

Items	Characteristics													
Category	-55 to +105°C(6.3 to 100V _{dc}) -40 to +105°C(160 to 400V _{dc}) -25 to +105°C(450V _{dc})													
Temperature Range														
Rated Voltage Range	6.3 to 450V _{dc}													
Capacitance Tolerance	±20% (M) (at 20°C, 120Hz)													
Leakage Current	6.3 to 100V _{dc}						160 to 450V _{dc}							
	I=0.03CV or 4μA, whichever is greater.						CV≤1,000		I=0.1CV+40 max.					
							CV>1,000		I=0.04CV+100 max.					
Where, I : Max. leakage current (μA), C : Nominal capacitance (μF), V : Rated voltage (V) (at 20°C after 1 minute)														
Dissipation Factor (tan δ)	Rated voltage (V _{dc})	6.3V	10V	16V	25V	35V	50V	63V	100V	160 to 250V	350 to 400V	450V		
	tan δ (Max.)	0.28	0.24	0.20	0.16	0.14	0.12	0.10	0.08	0.20	0.24	0.24		
When nominal capacitance exceeds 1,000μF, add 0.02 to the value above for each 1,000μF increase. (at 20°C, 120Hz)														
Low Temperature Characteristics (Max. Impedance Ratio)	Rated voltage (V _{dc})	6.3V	10V	16V	25V	35V	50V	63 to 100V	160 to 200V	250V	350V	400V	450V	
	Z(-25°C)/Z(+20°C)	≤φ8	5	4	3	2	2	2	2	3	3	4	4	6
		≥φ10	5	4	3	2	2	2	2	3	3	4	4	6
	Z(-40°C)/Z(+20°C)	≤φ8	10	8	6	4	3	3	3	8	10	8	8	—
≥φ10		10	8	6	4	3	3	3	4	4	6	6	—	
(at 120Hz)														
Endurance	The following specifications shall be satisfied when the capacitors are restored to 20°C after subjected to DC voltage with the rated ripple current is applied (the peak voltage shall not exceed the rated voltage) for 1,000 hours (2,000 hours for φ10 and more at 105°C).													
	Capacitance change	≤ ±20% of the initial value												
	D.F. (tan δ)	≤200% of the initial specified value												
	Leakage current	≤The initial specified value												
Shelf Life	The following specifications shall be satisfied when the capacitors are restored to 20°C after exposing them for 1,000 hours at 105°C without voltage applied. Before the measurement, the capacitor shall be preconditioned by applying voltage according to Item 4.1 of JIS C 5101-4.													
	Rated voltage	6.3 to 100V _{dc}						160 to 450V _{dc}						
	Capacitance change	≤ ±20% of the initial value						≤ ±20% of the initial value						
	D.F. (tan δ)	≤200% of the initial specified value						≤200% of the initial specified value						
	Leakage current	≤The initial specified value						≤500% of the initial specified value						

DIMENSIONS [mm]

- Terminal Code : E

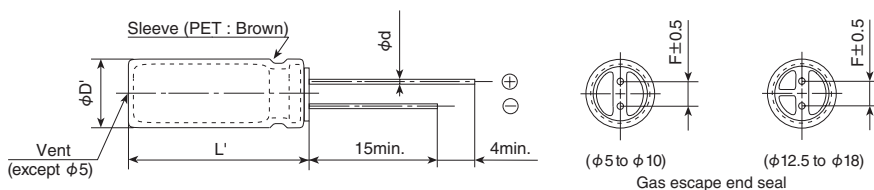

φD	5	6.3	8	10	12.5	16	18
φd	0.5	0.5	0.6	0.6	0.6	0.8	0.8
F	2.0	2.5	3.5	5.0	5.0	7.5	7.5
φD'	φD+0.5max.						
L'	L+1.5max.						

PART NUMBERING SYSTEM

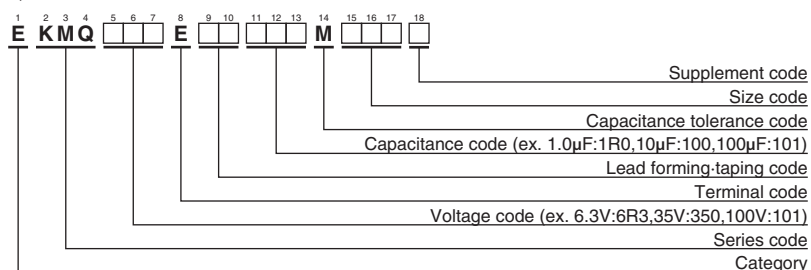

Please refer to "Product code guide (radial lead type)"

Return Group Chart



MINIATURE ALUMINUM ELECTROLYTIC CAPACITORS

Downsized, 105°C

KMQSeries

◆STANDARD RATINGS

is not solvent resistant.

WV (V _{dc})	Cap (μF)	Case size φD×L(mm)	tan δ	Rated ripple current (mA _{rms} /105°C, 120Hz)	Part No.	WV (V _{dc})	Cap (μF)	Case size φD×L(mm)	tan δ	Rated ripple current (mA _{rms} /105°C, 120Hz)	Part No.
400	22	12.5 × 25	0.24	145	EKMQ401E□□220MK25S	450	4.7	10 × 12.5	0.24	32	EKMQ451E□□4R7MJC5S
	33	16 × 25	0.24	195	EKMQ401E□□330ML25S		10	10 × 20	0.24	56	EKMQ451E□□100MJ20S
	47	16 × 25	0.24	200	EKMQ401E□□470ML25S		22	12.5 × 25	0.24	100	EKMQ451E□□220MK25S
	68	16 × 31.5	0.24	240	EKMQ401E□□680MLN3S		33	16 × 25	0.24	125	EKMQ451E□□330ML25S
	100	18 × 35.5	0.24	310	EKMQ401E□□101MMP1S		47	16 × 31.5	0.24	155	EKMQ451E□□470MLN3S
450	2.2	8 × 11.5	0.24	20	EKMQ451E□□2R2MHB5D	68	18 × 35.5	0.24	185	EKMQ451E□□680MMP1S	
	3.3	10 × 12.5	0.24	28	EKMQ451E□□3R3MJC5S	100	18 × 40	0.24	200	EKMQ451E□□101MM40S	

□□ : Enter the appropriate lead forming or taping code.

◆RATED RIPPLE CURRENT MULTIPLIERS

● Frequency Multipliers

Capacitance(μF)	Frequency(Hz)	50	120	300	1k	10k	100k
1.0 to 4.7		0.65	1.00	1.35	1.75	2.30	2.50
10 to 68		0.75	1.00	1.25	1.50	1.75	1.80
100 to 1,000		0.80	1.00	1.15	1.30	1.40	1.50
2,200 to		0.85	1.00	1.03	1.05	1.08	1.08

The endurance of capacitors is reduced with internal heating produced by ripple current at the rate of halving the lifetime with every 5°C rise. When long life performance is required in actual use, the rms ripple current has to be reduced.

Return Group Chart



MINIATURE ALUMINUM ELECTROLYTIC CAPACITORS

Standard, 85°C

SMG Series

- Endurance : 2,000 hours at 85°C
- Solvent resistant type except 350 to 450V_{dc} (see PRECAUTIONS AND GUIDELINES)
- RoHS Compliant

SMQ P143
↑
Downsized
SMG



SPECIFICATIONS

Items	Characteristics														
Category	-40 to +85°C (6.3 to 400V _{dc}) -25 to +85°C (450V _{dc})														
Temperature Range															
Rated Voltage Range	6.3 to 450V _{dc}														
Capacitance Tolerance	±20% (M) (at 20°C, 120Hz)														
Leakage Current	6.3 to 100V _{dc}									160 to 450V _{dc}					
	I=0.03CV or 4μA, whichever is greater.									CV / Time		After 1 minute		After 5 minute	
										CV ≤ 1,000		I=0.1CV+40 max.		I=0.03CV+15 max.	
										CV > 1,000		I=0.04CV+100 max.		I=0.02CV+25 max.	
Where, I : Max. leakage current (μA), C : Nominal capacitance (μF), V : Rated voltage (V) (at 20°C)															
Dissipation Factor (tan δ)	Rated voltage (V _{dc})	6.3V	10V	16V	25V	35V	50V	63V	100V	160 to 250V	350 to 400V	450V			
	tan δ (Max.)	0.34	0.24	0.20	0.16	0.14	0.12	0.09	0.08	0.20	0.24	0.24			
	When nominal capacitance exceeds 1,000μF, add 0.02 to the value above for each 1,000μF increase. (at 20°C, 120Hz)														
Low Temperature Characteristics (Max. Impedance Ratio)	Rated voltage (V _{dc})	6.3V	10V	16V	25V	35V	50V	63V	100V	160 to 250V	350 to 400V	450V			
	Z(-25°C)/Z(+20°C)	5	4	3	2	2	2	2	2	3	6	6			
	Z(-40°C)/Z(+20°C)	12	10	8	5	4	3	3	3	4	6	—			
(at 120Hz)															
Endurance	The following specifications shall be satisfied when the capacitors are restored to 20°C after the rated voltage is applied for 2,000 hours at 85°C.														
	Capacitance change	≤ ±20% of the initial value													
	D.F. (tan δ)	≤200% of the initial specified value													
	Leakage current	≤The initial specified value													
Shelf Life	The following specifications shall be satisfied when the capacitors are restored to 20°C after exposing them for 1,000 hours at 85°C without voltage applied. Before the measurement, the capacitor shall be preconditioned by applying voltage according to Item 4.1 of JIS C 5101-4.														
	Rated voltage	6.3 to 100V _{dc}						160 to 450V _{dc}							
	Capacitance change	≤ ±20% of the initial value						≤ ±20% of the initial value							
	D.F. (tan δ)	≤200% of the initial specified value						≤200% of the initial specified value							
	Leakage current	≤The initial specified value						≤500% of the initial specified value							

DIMENSIONS [mm]

- Terminal Code : E

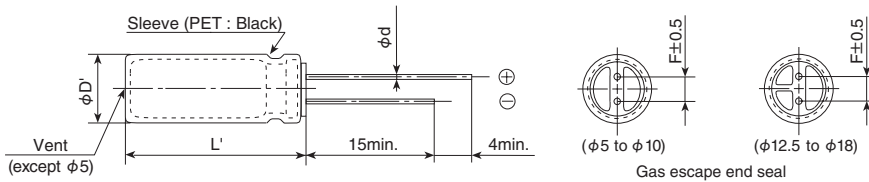

φD	5	6.3	8	10	12.5	16	18
φd	0.5	0.5	0.6	0.6	0.6	0.8	0.8
F	2.0	2.5	3.5	5.0	5.0	7.5	7.5
φD'	φD+0.5max.						
L'	L+1.5max.						

PART NUMBERING SYSTEM

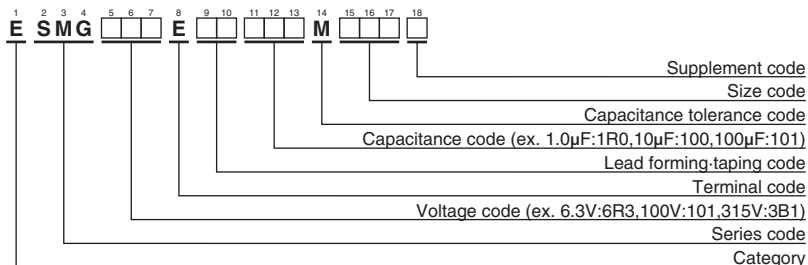

Please refer to "Product code guide (radial lead type)"

Return Group Chart



MINIATURE ALUMINUM ELECTROLYTIC CAPACITORS

Standard, 85°C

SMG Series

◆STANDARD RATINGS

is not solvent resistant.

WV (V _{dc})	Cap (μF)	Case size φD×L(mm)	tan δ	Rated ripple current (mA _{rms} /85°C, 120Hz)	Part No.	WV (V _{dc})	Cap (μF)	Case size φD×L(mm)	tan δ	Rated ripple current (mA _{rms} /85°C, 120Hz)	Part No.
450	4.7	10 × 20	0.24	56	ESMG451E□□4R7MJ20S	450	33	16 × 31.5	0.24	215	ESMG451E□□330MLN3S
	10	12.5 × 20	0.24	91	ESMG451E□□100MK20S		47	16 × 35.5	0.24	265	ESMG451E□□470MLP1S
	22	16 × 25	0.24	165	ESMG451E□□220ML25S						

□□ : Enter the appropriate lead forming or taping code.

◆RATED RIPPLE CURRENT MULTIPLIERS

⊙ Frequency Multipliers

Capacitance(μF) \ Frequency(Hz)	50	120	300	1k	10k	100k
1.0 to 4.7	0.65	1.00	1.35	1.75	2.30	2.50
10 to 47	0.75	1.00	1.25	1.50	1.75	1.80
100 to 1,000	0.80	1.00	1.15	1.30	1.40	1.50
2,200 to	0.85	1.00	1.03	1.05	1.08	1.08

The endurance of capacitors is reduced with internal heating produced by ripple current at the rate of halving the lifetime with every 5°C rise. When long life performance is required in actual use, the rms ripple current has to be reduced.

Return Group Chart



MINIATURE ALUMINUM ELECTROLYTIC CAPACITORS

Standard, 105°C

KMG Series

- Endurance with ripple current : 1,000 to 2,000 hours at 105°C
- Solvent resistant type except 350 to 450V_{dc}
(see PRECAUTIONS AND GUIDELINES)
- RoHS Compliant



SPECIFICATIONS

Items	Characteristics												
Category	-55 to +105°C(6.3 to 100V _{dc}) -40 to +105°C(160 to 400V _{dc}) -25 to +105°C(450V _{dc})												
Temperature Range													
Rated Voltage Range	6.3 to 450V _{dc}												
Capacitance Tolerance	±20% (M) (at 20°C, 120Hz)												
Leakage Current	6.3 to 100V _{dc}						160 to 450V _{dc}						
	I=0.03CV or 4μA, whichever is greater.												
	(after 1 minute)						CV	Time		After 1 minute		After 5 minutes	
							CV ≤ 1,000	I=0.1CV+40 max.		I=0.03CV+15 max.			
						CV > 1,000	I=0.04CV+100 max.		I=0.02CV+25 max.				
Where, I : Max. leakage current (μA), C : Nominal capacitance (μF), V : Rated voltage (V) (at 20°C)													
Dissipation Factor (tan δ)	Rated voltage (V _{dc})	6.3V	10V	16V	25V	35V	50V	63V	100V	160 to 250V	350 to 400V	450V	
	tan δ (Max.)	0.34	0.24	0.20	0.16	0.14	0.12	0.10	0.08	0.20	0.24	0.24	
	When nominal capacitance exceeds 1,000μF, add 0.02 to the value above for each 1,000μF increase. (at 20°C, 120Hz)												
Low Temperature Characteristics (Max. Impedance Ratio)	Rated voltage (V _{dc})	6.3V	10V	16V	25V	35V	50V	63V	100V	160 to 250V	350 to 400V	450V	
	Z(-25°C)/Z(+20°C)	5	4	3	2	2	2	2	2	3	6	6	
	Z(-40°C)/Z(+20°C)	12	10	8	5	4	3	3	3	4	6	—	
(at 120Hz)													
Endurance	The following specifications shall be satisfied when the capacitors are restored to 20°C after subjected to DC voltage with the rated ripple current is applied (the peak voltage shall not exceed the rated voltage) for 1,000 hours (2,000 hours to meet the following two conditions 1): 160V _{dc} and larger, 2) : φ 12.5 and larger) at 105°C.												
	Capacitance change	≤ ±20% of the initial value											
	D.F. (tan δ)	≤200% of the initial specified value											
	Leakage current	≤The initial specified value											
Shelf Life	The following specifications shall be satisfied when the capacitors are restored to 20°C after exposing them for 1,000 hours at 105°C without voltage applied. Before the measurement, the capacitor shall be preconditioned by applying voltage according to Item 4.1 of JIS C 5101-4.												
	Rated voltage	6.3 to 100V _{dc}						160 to 450V _{dc}					
	Capacitance change	≤ ±20% of the initial value						≤ ±20% of the initial value					
	D.F. (tan δ)	≤200% of the initial specified value						≤200% of the initial specified value					
	Leakage current	≤The initial specified value						≤500% of the initial specified value					

DIMENSIONS [mm]

- Terminal Code : E

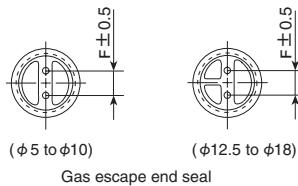
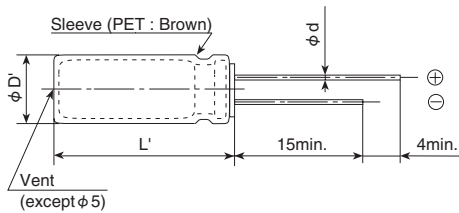

φD	5	6.3	8	10	12.5	16	18
φd	0.5	0.5	0.6	0.6	0.6	0.8	0.8
F	2.0	2.5	3.5	5.0	5.0	7.5	7.5
φD'	φD+0.5max						
L'	L+1.5max						

PART NUMBERING SYSTEM

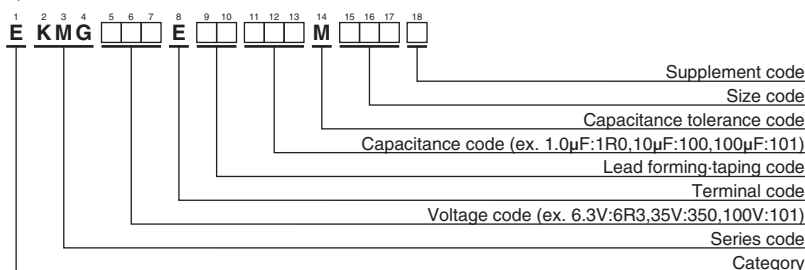

Please refer to "Product code guide (radial lead type)"



KMG Series

◆ **STANDARD RATINGS** is not solvent resistant.

WV (V _{dc})	Cap (μF)	Case size φD×L(mm)	tan δ	Rated ripple current (mA _{rms} / 105°C, 120Hz)	Part No.
450	2.2	10 × 12.5	0.24	23	EKMG451E <input type="checkbox"/> <input type="checkbox"/> 2R2MJC5S
	3.3	10 × 16	0.24	31	EKMG451E <input type="checkbox"/> <input type="checkbox"/> 3R3MJ16S
	4.7	10 × 20	0.24	40	EKMG451E <input type="checkbox"/> <input type="checkbox"/> 4R7MJ20S
	10	12.5 × 20	0.24	65	EKMG451E <input type="checkbox"/> <input type="checkbox"/> 100MK20S
	22	16 × 25	0.24	115	EKMG451E <input type="checkbox"/> <input type="checkbox"/> 220ML25S
	33	16 × 31.5	0.24	155	EKMG451E <input type="checkbox"/> <input type="checkbox"/> 330MLN3S
	47	16 × 35.5	0.24	185	EKMG451E <input type="checkbox"/> <input type="checkbox"/> 470MLP1S

: Enter the appropriate lead forming or taping code.

◆ **RATED RIPPLE CURRENT MULTIPLIERS**

● Frequency Multipliers

Capacitance(μF) \ Frequency(Hz)	50	120	300	1k	10k	100k
1.0 to 4.7	0.65	1.00	1.35	1.75	2.30	2.50
10 to 47	0.75	1.00	1.25	1.50	1.75	1.80
100 to 1,000	0.80	1.00	1.15	1.30	1.40	1.50
2,200 to	0.85	1.00	1.03	1.05	1.08	1.08

The endurance of capacitors is reduced with internal heating produced by ripple current at the rate of halving the lifetime with every 5°C rise. When long life performance is required in actual use, the rms ripple current has to be reduced.

Return Group Chart



MINIATURE ALUMINUM ELECTROLYTIC CAPACITORS

Low impedance, 105°C

KZN Series

- Adoption of innovative high stability electrolyte
- High ripple current and long endurance
- Rated voltage range : 6.3 to 100V_{dc}, Capacitance range : 8.2 to 22,000μF
- Endurance with ripple current : 6,000 to 10,000 hours at 105°C
- Non solvent resistant type
- RoHS Compliant

KZN

Higher ripple
KZM P158



◆ SPECIFICATIONS

Items	Characteristics									
Category Temperature Range	-40 to +105°C									
Rated Voltage Range	6.3 to 100V _{dc}									
Capacitance Tolerance	±20% (M) (at 20°C, 120Hz)									
Leakage Current	I=0.01CV or 3μA, whichever is greater. Where, I : Max. leakage current (μA), C : Nominal capacitance (μF), V : Rated voltage (V) (at 20°C after 2 minutes)									
Dissipation Factor (tan δ)	Rated voltage (V _{dc})	6.3V	10V	16V	25V	35V	50V	63V	80V	100V
	tan δ (Max.)	0.22	0.19	0.16	0.14	0.12	0.10	0.09	0.09	0.08
	When nominal capacitance exceeds 1,000μF, add 0.02 to the value above for each 1,000μF increase. (at 20°C, 120Hz)									
Low Temperature Characteristics	Z(-25°C)/Z(+20°C)	2 max. (at 120Hz)								
	Z(-40°C)/Z(+20°C)	3 max. (at 120Hz)								
Endurance	The following specifications shall be satisfied when the capacitors are restored to 20°C after subjected to DC voltage with the rated ripple current is applied (the peak voltage shall not exceed the rated voltage) for the specified period of time at 105°C.									
	Time	Case size	φ 5 & φ 6.3	φ 8 × 11.5L	φ 10 × 12.5L	φ 8 × 15L, 20L	φ 10 × 16L, 20L, 25L φ 12.5 to φ 18			
		6.3V _{dc}	6,000 hours	8,000 hours	9,000 hours	9,000 hours	10,000 hours			
		10 to 50V _{dc}	7,000 hours	9,000 hours	9,000 hours	10,000 hours	10,000 hours			
		63 to 100V _{dc}	6,000 hours	8,000 hours	9,000 hours	9,000 hours	10,000 hours			
	Capacitance change	≤ ±25% of the initial value (6.3, 10V _{dc} : ≤ ±30%)								
	D.F. (tan δ)	≤ 200% of the initial specified value								
Leakage current	≤ The initial specified value									
Shelf Life	The following specifications shall be satisfied when the capacitors are restored to 20°C after exposing them for 500 hours at 105°C without voltage applied. Before the measurement, the capacitor shall be preconditioned by applying voltage according to Item 4.1 of JIS C 5101-4.									
	Capacitance change	≤ ±25% of the initial value (6.3, 10V _{dc} : ≤ ±30%)								
	D.F. (tan δ)	≤ 200% of the initial specified value								
	Leakage current	≤ The initial specified value								

◆ DIMENSIONS [mm]

- Terminal Code : E

Sleeve(PET : Brown)

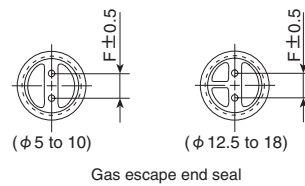
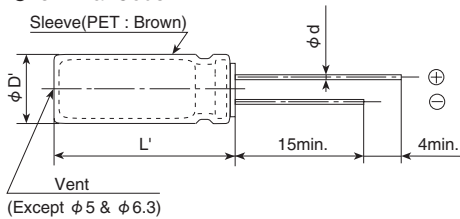

φ D	5	6.3	8	10	12.5	16	18
φ d	0.5	0.5	0.6	0.6	0.6	0.8	0.8
F	2.0	2.5	3.5	5.0	5.0	7.5	7.5
D'	φ D + 0.5max.						
L'	L + 1.5max.						

◆ PART NUMBERING SYSTEM

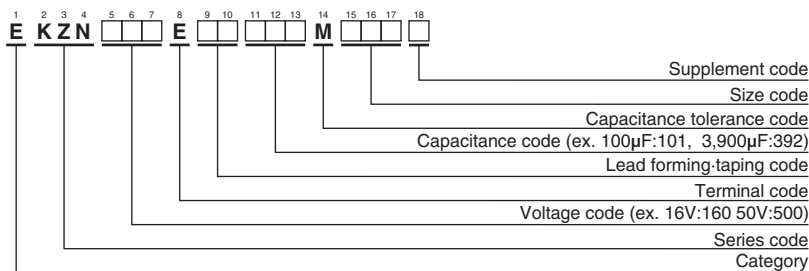

Please refer to "Product code guide (radial lead type)"

Return Group Chart



MINIATURE ALUMINUM ELECTROLYTIC CAPACITORS

Low impedance, 105°C

KZM Series

- Long-Life version of KZH series
- Endurance with ripple current : 6,000 to 10,000 hours at 105°C
- Newly innovative electrolyte is employed to minimize ESR
- Rated voltage range : 6.3 to 50V_{dc}, Nominal capacitance range : 27 to 10,000μF
- Non solvent resistant type
- RoHS Compliant



◆ SPECIFICATIONS

Items	Characteristics
Category	-40 to +105°C
Temperature Range	
Rated Voltage Range	6.3 to 50V _{dc}
Capacitance Tolerance	±20% (M) (at 20°C, 120Hz)
Leakage Current	I=0.01CV or 3μA, whichever is greater. Where, I : Max. leakage current (μA), C : Nominal capacitance (μF), V : Rated voltage (V) (at 20°C after 2 minutes)
Dissipation Factor (tan δ)	Rated voltage (V _{dc}) 6.3V 10V 16V 25V 35V 50V tan δ (Max.) 0.22 0.19 0.16 0.14 0.12 0.10 When nominal capacitance exceeds 1,000μF, add 0.02 to the value above for each 1,000μF increase. (at 20°C, 120Hz)
Low Temperature Characteristics	Z(-25°C)/Z(+20°C) 2 max. Z(-40°C)/Z(+20°C) 3 max. (at 120Hz)
Endurance	The following specifications shall be satisfied when the capacitors are restored to 20°C after subjected to DC voltage with the rated ripple current is applied (the peak voltage shall not exceed the rated voltage) for the specified period of time at 105°C. Time φ 5 & φ 6.3 : 6,000hours φ 8 : 8,000hours φ 10 to φ 18 : 10,000hours Capacitance change ≤ ±25% of the initial value (6.3, 10V _{dc} : ≤ ± 30%) D.F. (tan δ) ≤ 200% of the initial specified value Leakage current ≤ The initial specified value
Shelf Life	The following specifications shall be satisfied when the capacitors are restored to 20°C after exposing them for 500 hours at 105°C without voltage applied. Before the measurement, the capacitor shall be preconditioned by applying voltage according to Item 4.1 of JIS C 5101-4. Capacitance change ≤ ±25% of the initial value (6.3, 10V _{dc} : ≤ ± 30%) D.F. (tan δ) ≤ 200% of the initial specified value Leakage current ≤ The initial specified value

◆ DIMENSIONS [mm]

- Terminal Code : E

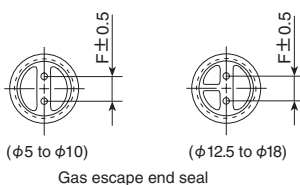
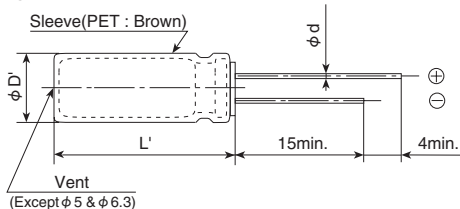

φD	5	6.3	8	10	12.5	16	18
φd	0.5	0.5	0.6	0.6	0.6	0.8	0.8
F	2.0	2.5	3.5	5.0	5.0	7.5	7.5
φD'	φD+0.5max.						
L'	L+1.5max.						

◆ PART NUMBERING SYSTEM

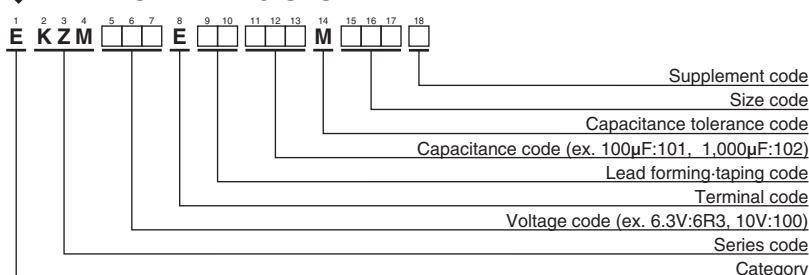

Please refer to "Product code guide (radial lead type)"

◆ RATED RIPPLE CURRENT MULTIPLIERS

- Frequency Multipliers

Capacitance(μF)	Frequency(Hz)	120	1k	10k	100k
27 to 180		0.40	0.75	0.90	1.00
220 to 560		0.50	0.85	0.94	1.00
680 to 1,800		0.60	0.87	0.95	1.00
2,200 to 3,900		0.75	0.90	0.95	1.00
4,700 to 10,000		0.85	0.95	0.98	1.00

Note : The endurance of capacitors is reduced with internal heating produced by ripple current at the rate of halving the lifetime with every 5°C rise. When long life performance is required in actual use, the rms ripple current has to be reduced.

Return Group Chart



MINIATURE ALUMINUM ELECTROLYTIC CAPACITORS

Low impedance, 105°C

KZMSeries

◆STANDARD RATINGS

WV (V _{dc})	Cap (μF)	Case size φD×L(mm)	tan δ	Impedance (Ω max./100kHz)		Rated ripple current (mArms/105°C, 100kHz)	Part No.
				20°C	-10°C		
6.3	220	5 × 11	0.22	0.22	0.80	345	EKZM6R3E□□221ME11D
	470	6.3 × 11	0.22	0.094	0.35	540	EKZM6R3E□□471MF11D
	820	8 × 11.5	0.22	0.056	0.19	945	EKZM6R3E□□821MHB5D
	1,200	8 × 15	0.22	0.045	0.15	1,250	EKZM6R3E□□122MH15D
	1,200	10 × 12.5	0.22	0.039	0.14	1,330	EKZM6R3E□□122MJC5S
	1,500	8 × 20	0.22	0.029	0.11	1,500	EKZM6R3E□□152MH20D
	1,800	10 × 16	0.22	0.028	0.10	1,760	EKZM6R3E□□182MJ16S
	2,200	10 × 20	0.24	0.020	0.060	1,960	EKZM6R3E□□222MJ20S
	2,700	10 × 25	0.24	0.018	0.054	2,250	EKZM6R3E□□272MJ25S
	3,900	12.5 × 20	0.26	0.017	0.043	2,480	EKZM6R3E□□392MK20S
	4,700	12.5 × 25	0.28	0.015	0.038	2,900	EKZM6R3E□□472MK25S
	5,600	12.5 × 30	0.30	0.013	0.033	3,450	EKZM6R3E□□562MK30S
	6,800	12.5 × 35	0.32	0.012	0.031	3,570	EKZM6R3E□□682MK35S
	6,800	16 × 20	0.32	0.015	0.038	3,250	EKZM6R3E□□682ML20S
8,200	16 × 25	0.36	0.013	0.035	3,630	EKZM6R3E□□822ML25S	
10,000	18 × 25	0.40	0.012	0.031	3,650	EKZM6R3E□□103MM25S	
10	150	5 × 11	0.19	0.22	0.80	345	EKZM100E□□151ME11D
	330	6.3 × 11	0.19	0.094	0.35	540	EKZM100E□□331MF11D
	680	8 × 11.5	0.19	0.056	0.19	945	EKZM100E□□681MHB5D
	1,000	8 × 15	0.19	0.045	0.15	1,250	EKZM100E□□102MH15D
	1,000	10 × 12.5	0.19	0.039	0.14	1,330	EKZM100E□□102MJC5S
	1,500	8 × 20	0.19	0.029	0.11	1,500	EKZM100E□□152MH20D
	1,500	10 × 16	0.19	0.028	0.10	1,760	EKZM100E□□152MJ16S
	1,800	10 × 20	0.19	0.020	0.060	1,960	EKZM100E□□182MJ20S
	2,200	10 × 25	0.21	0.018	0.054	2,250	EKZM100E□□222MJ25S
	3,300	12.5 × 20	0.23	0.017	0.043	2,480	EKZM100E□□332MK20S
	3,900	12.5 × 25	0.23	0.015	0.038	2,900	EKZM100E□□392MK25S
	4,700	12.5 × 30	0.25	0.013	0.033	3,450	EKZM100E□□472MK30S
	4,700	16 × 20	0.25	0.015	0.038	3,250	EKZM100E□□472ML20S
	5,600	12.5 × 35	0.27	0.012	0.031	3,570	EKZM100E□□562MK35S
6,800	16 × 25	0.29	0.013	0.035	3,630	EKZM100E□□682ML25S	
8,200	18 × 25	0.33	0.012	0.031	3,650	EKZM100E□□822MM25S	
16	100	5 × 11	0.16	0.22	0.80	345	EKZM160E□□101ME11D
	220	6.3 × 11	0.16	0.094	0.35	540	EKZM160E□□221MF11D
	470	8 × 11.5	0.16	0.056	0.19	945	EKZM160E□□471MHB5D
	680	8 × 15	0.16	0.045	0.15	1,250	EKZM160E□□681MH15D
	680	10 × 12.5	0.16	0.039	0.14	1,330	EKZM160E□□681MJC5S
	1,000	8 × 20	0.16	0.029	0.11	1,500	EKZM160E□□102MH20D
	1,000	10 × 16	0.16	0.028	0.10	1,760	EKZM160E□□102MJ16S
	1,500	10 × 20	0.16	0.020	0.060	1,960	EKZM160E□□152MJ20S
	1,800	10 × 25	0.16	0.018	0.054	2,250	EKZM160E□□182MJ25S
	2,200	12.5 × 20	0.18	0.017	0.043	2,480	EKZM160E□□222MK20S
	2,700	12.5 × 25	0.18	0.015	0.038	2,900	EKZM160E□□272MK25S
	3,300	12.5 × 30	0.20	0.013	0.033	3,450	EKZM160E□□332MK30S
	3,300	16 × 20	0.20	0.015	0.038	3,250	EKZM160E□□332ML20S
	3,900	12.5 × 35	0.20	0.012	0.031	3,570	EKZM160E□□392MK35S
	4,700	16 × 25	0.22	0.013	0.035	3,630	EKZM160E□□472ML25S
	5,600	18 × 25	0.24	0.012	0.031	3,650	EKZM160E□□562MM25S

□□ : Enter the appropriate lead forming or taping code.

Return Group Chart



MINIATURE ALUMINUM ELECTROLYTIC CAPACITORS

Low impedance, 105°C

KZMSeries

◆STANDARD RATINGS

WV (V _{dc})	Cap (μF)	Case size φD×L(mm)	tan δ	Impedance (Ω max./100kHz)		Rated ripple current (mArms/105°C, 100kHz)	Part No.
				20°C	-10°C		
25	68	5 × 11	0.14	0.22	0.80	345	EKZM250E□□680ME11D
	150	6.3 × 11	0.14	0.094	0.35	540	EKZM250E□□151MF11D
	330	8 × 11.5	0.14	0.056	0.19	945	EKZM250E□□331MHB5D
	390	8 × 15	0.14	0.045	0.15	1,250	EKZM250E□□391MH15D
	470	10 × 12.5	0.14	0.039	0.14	1,330	EKZM250E□□471MJC5S
	560	8 × 20	0.14	0.029	0.11	1,500	EKZM250E□□561MH20D
	680	10 × 16	0.14	0.028	0.10	1,760	EKZM250E□□681MJ16S
	820	10 × 20	0.14	0.020	0.060	1,960	EKZM250E□□821MJ20S
	1,000	10 × 25	0.14	0.018	0.054	2,250	EKZM250E□□102MJ25S
	1,500	12.5 × 20	0.14	0.017	0.043	2,480	EKZM250E□□152MK20S
	1,800	12.5 × 25	0.14	0.015	0.038	2,900	EKZM250E□□182MK25S
	2,200	12.5 × 30	0.16	0.013	0.033	3,450	EKZM250E□□222MK30S
	2,200	16 × 20	0.16	0.015	0.038	3,250	EKZM250E□□222ML20S
	2,700	12.5 × 35	0.16	0.012	0.031	3,570	EKZM250E□□272MK35S
3,300	16 × 25	0.18	0.013	0.035	3,630	EKZM250E□□332ML25S	
3,900	18 × 25	0.18	0.012	0.031	3,650	EKZM250E□□392MM25S	
35	47	5 × 11	0.12	0.22	0.80	345	EKZM350E□□470ME11D
	100	6.3 × 11	0.12	0.094	0.35	540	EKZM350E□□101MF11D
	220	8 × 11.5	0.12	0.056	0.19	945	EKZM350E□□221MHB5D
	270	8 × 15	0.12	0.045	0.15	1,250	EKZM350E□□271MH15D
	330	10 × 12.5	0.12	0.039	0.14	1,330	EKZM350E□□331MJC5S
	390	8 × 20	0.12	0.029	0.11	1,500	EKZM350E□□391MH20D
	470	10 × 16	0.12	0.028	0.10	1,760	EKZM350E□□471MJ16S
	560	10 × 20	0.12	0.020	0.060	1,960	EKZM350E□□561MJ20S
	680	10 × 25	0.12	0.018	0.054	2,250	EKZM350E□□681MJ25S
	1,000	12.5 × 20	0.12	0.017	0.043	2,480	EKZM350E□□102MK20S
	1,200	12.5 × 25	0.12	0.015	0.038	2,900	EKZM350E□□122MK25S
	1,500	12.5 × 30	0.12	0.013	0.033	3,450	EKZM350E□□152MK30S
	1,500	16 × 20	0.12	0.015	0.038	3,250	EKZM350E□□152ML20S
	1,800	12.5 × 35	0.12	0.012	0.031	3,570	EKZM350E□□182MK35S
2,200	16 × 25	0.14	0.013	0.035	3,630	EKZM350E□□222ML25S	
2,700	18 × 25	0.14	0.012	0.031	3,650	EKZM350E□□272MM25S	
50	27	5 × 11	0.10	0.34	1.18	238	EKZM500E□□270ME11D
	56	6.3 × 11	0.10	0.14	0.50	385	EKZM500E□□560MF11D
	100	8 × 11.5	0.10	0.074	0.22	724	EKZM500E□□101MHB5D
	120	8 × 15	0.10	0.061	0.18	950	EKZM500E□□121MH15D
	150	10 × 12.5	0.10	0.061	0.18	979	EKZM500E□□151MJC5S
	180	8 × 20	0.10	0.046	0.14	1,190	EKZM500E□□181MH20D
	220	10 × 16	0.10	0.042	0.12	1,370	EKZM500E□□221MJ16S
	270	10 × 20	0.10	0.030	0.090	1,580	EKZM500E□□271MJ20S
	330	10 × 25	0.10	0.028	0.085	1,870	EKZM500E□□331MJ25S
	470	12.5 × 20	0.10	0.027	0.068	2,050	EKZM500E□□471MK30S
	560	12.5 × 25	0.10	0.023	0.059	2,410	EKZM500E□□561MK25S
	680	12.5 × 30	0.10	0.021	0.052	2,860	EKZM500E□□681MK30S
	820	12.5 × 35	0.10	0.019	0.051	2,960	EKZM500E□□821MK35S
	820	16 × 20	0.10	0.023	0.059	2,730	EKZM500E□□821ML20S
1,000	16 × 25	0.10	0.021	0.056	3,010	EKZM500E□□102ML25S	
1,500	18 × 25	0.10	0.019	0.051	3,290	EKZM500E□□152MM25S	

□□ : Enter the appropriate lead forming or taping code.

Return Group Chart



MINIATURE ALUMINUM ELECTROLYTIC CAPACITORS

Low impedance, 105°C

KZH Series

- Newly innovative electrolyte is employed to minimize impedance
- Endurance with ripple current: 5,000 to 6,000 hours at 105°C
- Non solvent resistant type
- RoHS Compliant



SPECIFICATIONS

Items	Characteristics					
Category	-40 to +105°C					
Temperature Range	-40 to +105°C					
Rated Voltage Range	6.3 to 35V _{dc}					
Capacitance Tolerance	±20% (M) (at 20°C, 120Hz)					
Leakage Current	I=0.01CV or 3μA, whichever is greater. Where, I : Max. leakage current (μA), C : Nominal capacitance (μF), V : Rated voltage (V) (at 20°C after 2 minutes)					
Dissipation Factor (tan δ)	Rated voltage (V _{dc})	6.3V	10V	16V	25V	35V
	tan δ (Max.)	0.22	0.19	0.16	0.14	0.12
	When nominal capacitance exceeds 1,000μF, add 0.02 to the value above for each 1,000μF increase. (at 20°C, 120Hz)					
Low Temperature Characteristics (Max. Impedance Ratio)	Z (-25°C) / Z (+20°C)	2max.				
	Z (-40°C) / Z (+20°C)	3max.				
Endurance	The following specifications shall be satisfied when the capacitors are restored to 20°C after subjected to DC voltage with the rated ripple current is applied (the peak voltage shall not exceed the rated voltage) for the specified period of time at 105°C.					
	Time	φ 5 & φ 6.3 : 5,000hours φ 8 to φ 16 : 6,000hours				
	Capacitance change	≤ ±25% of the initial value (6.3, 10V _{dc} : ≤ ±30%)				
	D.F. (tan δ)	≤200% of the initial specified value				
	Leakage current	≤The initial specified value				
Shelf Life	The following specifications shall be satisfied when the capacitors are restored to 20°C after exposing them for 500 hours at 105°C without voltage applied. Before the measurement, the capacitor shall be preconditioned by applying voltage according to Item 4.1 of JIS C 5101-4.					
	Capacitance change	≤ ±25% of the initial value (6.3, 10V _{dc} : ≤ ±30%)				
	D.F. (tan δ)	≤200% of the initial specified value				
	Leakage current	≤The initial specified value				

DIMENSIONS [mm]

- Terminal Code : E

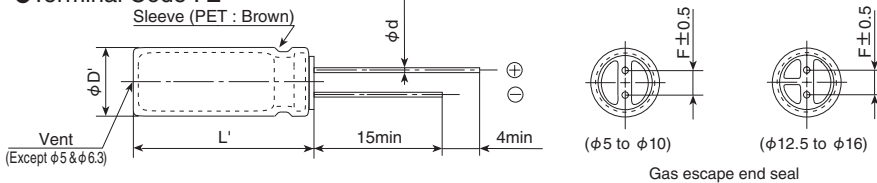

φD	5	6.3	8	10	12.5	16
φd	0.5	0.5	0.6	0.6	0.6	0.8
F	2.0	2.5	3.5	5.0	5.0	7.5
φD'	φD+0.5max.					
L'	L+1.5max.					

PART NUMBERING SYSTEM

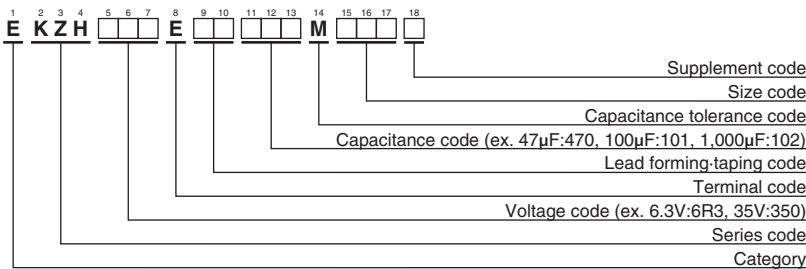

Please refer to "Product code guide (radial lead type)"

Return Group Chart



MINIATURE ALUMINUM ELECTROLYTIC CAPACITORS

Low impedance, 105°C

KZE Series

- Newly innovative electrolyte is employed to minimize impedance
- Endurance with ripple current: 1,000 to 5,000 hours at 105°C
- Non solvent resistant type
- RoHS Compliant



SPECIFICATIONS

Items	Characteristics	
Category	-40 to +105°C	
Temperature Range	-40 to +105°C	
Rated Voltage Range	6.3 to 100V _{dc}	
Capacitance Tolerance	±20% (M) (at 20°C, 120Hz)	
Leakage Current	I=0.01CV or 3µA, whichever is greater. Where, I : Max. leakage current (µA), C : Nominal capacitance (µF), V : Rated voltage (V) (at 20°C after 2 minutes)	
Dissipation Factor (tan δ)	Rated voltage (V _{dc})	6.3V 10V 16V 25V 35V 50V 63V 80V 100V
	tan δ (Max.)	0.22 0.19 0.16 0.14 0.12 0.10 0.09 0.09 0.08
	When nominal capacitance exceeds 1,000µF, add 0.02 to the value above for each 1,000µF increase. (at 20°C, 120Hz)	
Low Temperature Characteristics (Max. Impedance Ratio)	Z (-25°C) / Z (+20°C)	2max.
	Z (-40°C) / Z (+20°C)	3max.
Endurance	The following specifications shall be satisfied when the capacitors are restored to 20°C after subjected to DC voltage with the rated ripple current is applied (the peak voltage shall not exceed the rated voltage) for the specified period of time at 105°C.	
	Time	7L : 1,000hours φ5 & φ6.3 : 2,000hours φ8 : 3,000hours φ10 : 4,000hours φ12.5 to φ18 : 5,000hours
	Capacitance change	≤ ±25% of the initial value
	D.F. (tan δ)	≤ 200% of the initial specified value
	Leakage current	≤ The initial specified value
Shelf Life	The following specifications shall be satisfied when the capacitors are restored to 20°C after exposing them for 500 hours at 105°C without voltage applied. Before the measurement, the capacitor shall be preconditioned by applying voltage according to Item 4.1 of JIS C 5101-4.	
	Capacitance change	≤ ±25% of the initial value
	D.F. (tan δ)	≤ 200% of the initial specified value
	Leakage current	≤ The initial specified value

DIMENSIONS [mm]

- Terminal Code : E

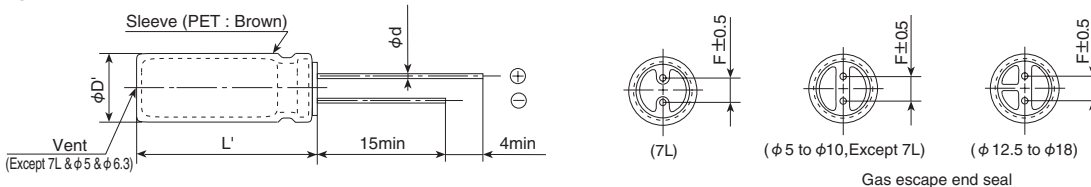

φD	5	6.3	8	10, 12.5	16, 18
φd	7L 0.45	0.45	0.45	—	—
	11L~ 0.5	0.5	0.6	0.6	0.8
F	2.0	2.5	3.5	5.0	7.5
φD'	φD+0.5max.				
L'	L+1.5max.(7L : L+1.0max.)				

PART NUMBERING SYSTEM

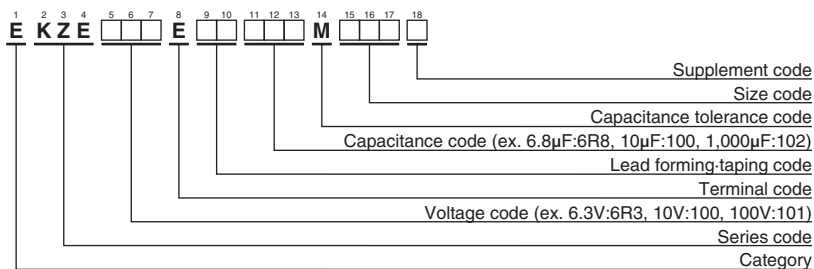

Please refer to "Product code guide (radial lead type)"

Return Group Chart



MINIATURE ALUMINUM ELECTROLYTIC CAPACITORS

Low impedance, 105°C

KZE Series

◆STANDARD RATINGS

WV (V _{dc})	Cap (μF)	Case size φD×L(mm)	Impedance (Ω max./100kHz)		Rated ripple current (mA _{rms} /105°C, 100kHz)	Part No.	WV (V _{dc})	Cap (μF)	Case size φD×L(mm)	Impedance (Ω max./100kHz)		Rated ripple current (mA _{rms} /105°C, 100kHz)	Part No.
			20°C	-10°C						20°C	-10°C		
63	1,200	18×31.5	0.020	0.060	3,300	EKZE630E□□122MMN3S	100	6.8	5×11	1.4	5.6	125	EKZE101E□□6R8ME11D
	1,500	18×35.5	0.018	0.054	3,400	EKZE630E□□152MMP1S		15	6.3×11	0.57	2.3	205	EKZE101E□□150MF11D
	1,800	18×40	0.017	0.051	3,500	EKZE630E□□182MM40S		27	8×11.5	0.36	1.4	355	EKZE101E□□270MHB5D
80	68	10×12.5	0.17	0.66	480	EKZE800E□□680MJC5S		39	8×15	0.25	1.0	450	EKZE101E□□390MH15D
	100	10×16	0.11	0.47	600	EKZE800E□□101MJ16S		47	10×12.5	0.17	0.66	480	EKZE101E□□470MJC5S
	120	10×20	0.084	0.34	800	EKZE800E□□121MJ20S		56	8×20	0.19	0.76	565	EKZE101E□□560MH20D
	150	10×25	0.069	0.28	900	EKZE800E□□151MJ25S		68	10×16	0.11	0.47	600	EKZE101E□□680MJ16S
	150	12.5×16	0.11	0.34	750	EKZE800E□□151MK16S		82	10×20	0.084	0.34	800	EKZE101E□□820MJ20S
	220	12.5×20	0.062	0.18	1,100	EKZE800E□□221MK20S		100	12.5×16	0.11	0.34	750	EKZE101E□□101MK16S
	330	12.5×25	0.047	0.14	1,250	EKZE800E□□331MK25S		120	10×25	0.069	0.28	900	EKZE101E□□121MJ25S
	330	16×20	0.048	0.15	1,350	EKZE800E□□331ML20S		150	12.5×20	0.062	0.18	1,100	EKZE101E□□151MK20S
	390	12.5×30	0.042	0.13	1,500	EKZE800E□□391MK30S		220	12.5×25	0.047	0.14	1,250	EKZE101E□□221MK25S
	470	12.5×35	0.036	0.11	1,650	EKZE800E□□471MK35S		220	16×20	0.048	0.15	1,350	EKZE101E□□221ML20S
	470	16×25	0.038	0.12	1,700	EKZE800E□□471ML25S		270	12.5×30	0.042	0.13	1,500	EKZE101E□□271MK30S
	470	18×20	0.045	0.14	1,500	EKZE800E□□471MM20S		330	12.5×35	0.036	0.11	1,650	EKZE101E□□331MK35S
	560	12.5×40	0.032	0.095	1,800	EKZE800E□□561MK40S		330	16×25	0.038	0.12	1,700	EKZE101E□□331ML25S
	680	16×31.5	0.032	0.095	1,850	EKZE800E□□681MLN3S		330	18×20	0.045	0.14	1,500	EKZE101E□□331MM20S
	680	18×25	0.036	0.11	1,750	EKZE800E□□681MM25S		390	12.5×40	0.032	0.095	1,800	EKZE101E□□391MK40S
	820	16×35.5	0.029	0.086	2,000	EKZE800E□□821MLP1S		470	16×31.5	0.032	0.095	1,850	EKZE101E□□471MLN3S
	820	18×31.5	0.030	0.090	1,900	EKZE800E□□821MMN3S		470	18×25	0.036	0.11	1,750	EKZE101E□□471MM25S
	1,000	16×40	0.027	0.081	2,200	EKZE800E□□102ML40S		560	16×35.5	0.029	0.086	2,000	EKZE101E□□561MLP1S
	1,000	18×35.5	0.027	0.081	2,200	EKZE800E□□102MMP1S		560	18×31.5	0.030	0.090	1,900	EKZE101E□□561MMN3S
	1,200	18×40	0.026	0.077	2,700	EKZE800E□□122MM40S		680	16×40	0.027	0.081	2,200	EKZE101E□□681ML40S
						680		18×35.5	0.027	0.081	2,200	EKZE101E□□681MMP1S	
						820		18×40	0.026	0.077	2,700	EKZE101E□□821MM40S	

□□ : Enter the appropriate lead forming or taping code.

◆RATED RIPPLE CURRENT MULTIPLIERS

● Frequency Multipliers

7L

Capacitance(μF)	Frequency(Hz)	120	1k	10k	100k
10 to 33		0.42	0.70	0.90	1.00
39 to 220		0.50	0.73	0.92	1.00

11L to 40L

Capacitance(μF)	Frequency(Hz)	120	1k	10k	100k
6.8 to 180		0.40	0.75	0.90	1.00
220 to 560		0.50	0.85	0.94	1.00
680 to 1,800		0.60	0.87	0.95	1.00
2,200 to 3,900		0.75	0.90	0.95	1.00
4,700 to		0.85	0.95	0.98	1.00

The endurance of capacitors is reduced with internal heating produced by ripple current at the rate of halving the lifetime with every 5°C rise. When long life performance is required in actual use, the rms ripple current has to be reduced.

Return Group Chart



MINIATURE ALUMINUM ELECTROLYTIC CAPACITORS

Low impedance, 105°C

KYB Series

- Low impedance, high ripple and long life from KYA series
- Newly innovative electrolyte is employed to minimize impedance
- Endurance with ripple current : 4,000 to 10,000 hours at 105°C
- Non solvent resistant type
- RoHS Compliant

KYB
↑ Lower Z
KYA P169



◆ SPECIFICATIONS

Items	Characteristics										
Category Temperature Range	-40 to +105°C										
Rated Voltage Range	6.3 to 100V _{dc}										
Capacitance Tolerance	±20% (M) (at 20°C, 120Hz)										
Leakage Current	I=0.01CV or 3μA, whichever is greater. Where, I : Max. leakage current (μA), C : Nominal capacitance (μF), V : Rated voltage (V) (at 20°C after 2 minutes)										
Dissipation Factor (tan δ)	Rated voltage (V _{dc})	6.3V	10V	16V	25V	35V	50V	63V	80V	100V	
	tan δ (Max.)	0.22	0.19	0.16	0.14	0.12	0.10	0.09	0.09	0.08	
	When nominal capacitance exceeds 1,000μF, add 0.02 to the value above for each 1,000μF increase. (at 20°C, 120Hz)										
Low Temperature Characteristics (Max. Impedance Ratio)	Rated voltage (V _{dc})	6.3V	10V	16V	25V	35V	50V	63V	80V	100V	
	Z(-25°C)/Z(+20°C)	4	3	2	2	2	2	2	2	2	
	Z(-40°C)/Z(+20°C)	8	6	4	3	3	3	3	3	3	
Endurance	The following specifications shall be satisfied when the capacitors are restored to 20°C after subjected to DC voltage with the rated ripple current is applied (the peak voltage shall not exceed the rated voltage) for the specified period of time at 105°C.										
	Rated Voltage(V _{dc})	6.3 to 10V _{dc}					16 to 100V _{dc}				
	Time	φ 5: 4,000hours φ 6.3 & 8: 6,000hours φ 10 to 18: 8,000hours					φ 5: 5,000hours φ 6.3 & 8: 7,000hours φ 10 to 18: 10,000hours				
	Capacitance change	≤ ±30% of the initial value					≤ ±25% of the initial value				
	D.F. (tan δ)	≤200% of the initial specified value					≤200% of the initial specified value				
	Leakage current	≤The initial specified value					≤The initial specified value				
Shelf Life	The following specifications shall be satisfied when the capacitors are restored to 20°C after exposing them for 500 hours at 105°C without voltage applied. Before the measurement, the capacitor shall be preconditioned by applying voltage according to Item 4.1 of JIS C 5101-4.										
	Capacitance change	≤ ±25% of the initial value									
	D.F. (tan δ)	≤200% of the initial specified value									
	Leakage current	≤The initial specified value									

◆ DIMENSIONS [mm]

● Terminal Code : E

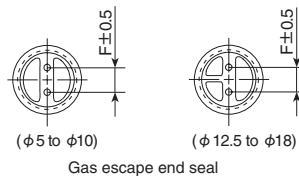
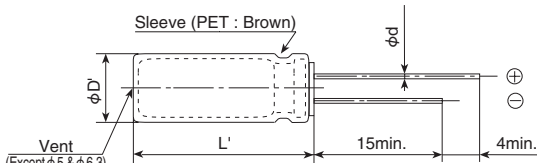

φD	5	6.3	8	10	12.5	16	18
φd	0.5	0.5	0.6	0.6	0.6	0.8	0.8
F	2.0	2.5	3.5	5.0	5.0	7.5	7.5
φD'	φD+0.5max.						
L'	L+1.5max.						

◆ PART NUMBERING SYSTEM

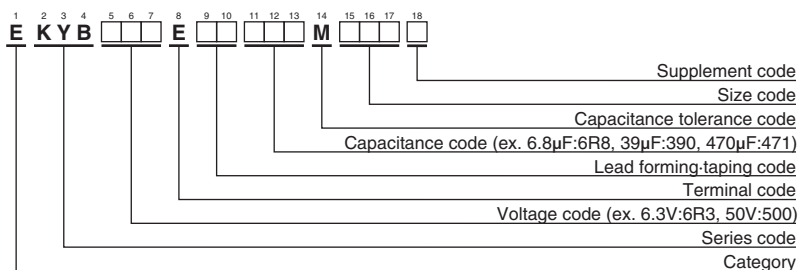

Please refer to "Product code guide (radial lead type)"

Return Group Chart



MINIATURE ALUMINUM ELECTROLYTIC CAPACITORS

Low impedance, 105°C



◆STANDARD RATINGS

WV (V _{dc})	Cap (μF)	Case size φD×L(mm)	Impedance (Ω max./100kHz)		Rated ripple current (mArms/ 105°C, 100kHz)	Part No.	WV (V _{dc})	Cap (μF)	Case size φD×L(mm)	Impedance (Ω max./100kHz)		Rated ripple current (mArms/ 105°C, 100kHz)	Part No.
			20°C	-10°C						20°C	-10°C		
50	180	8×20	0.075	0.30	980	EKYB500E□□181MH20D	80	56	8×15	0.14	0.56	585	EKYB800E□□560MH15D
	220	10×16	0.069	0.28	1,100	EKYB500E□□221MJ16S		82	8×20	0.11	0.44	735	EKYB800E□□820MH20D
	270	10×20	0.055	0.22	1,300	EKYB500E□□271MJ20S		82	10×12.5	0.14	0.56	624	EKYB800E□□820MJC5S
	390	10×25	0.043	0.18	1,600	EKYB500E□□391MJ25S		120	10×16	0.10	0.40	780	EKYB800E□□121MJ16S
	470	10×30	0.038	0.16	1,820	EKYB500E□□471MJ30S		180	10×20	0.075	0.30	1,040	EKYB800E□□181MJ20S
	470	12.5×20	0.034	0.14	1,820	EKYB500E□□471MK20S		220	10×25	0.060	0.24	1,170	EKYB800E□□221MJ25S
	680	12.5×25	0.030	0.12	2,100	EKYB500E□□681MK25S		270	10×30	0.053	0.22	1,350	EKYB800E□□271MJ30S
	820	12.5×30	0.025	0.10	2,450	EKYB500E□□821MK30S		270	12.5×20	0.048	0.20	1,430	EKYB800E□□271MK20S
	820	16×20	0.028	0.12	2,350	EKYB500E□□821ML20S		390	12.5×25	0.039	0.16	1,620	EKYB800E□□391MK25S
	1,000	12.5×35	0.021	0.084	2,800	EKYB500E□□102MK35S		470	12.5×30	0.033	0.14	1,950	EKYB800E□□471MK30S
	1,000	18×20	0.025	0.10	2,600	EKYB500E□□102MM20S		470	16×20	0.036	0.15	1,750	EKYB800E□□471ML20S
	1,200	12.5×40	0.019	0.076	3,100	EKYB500E□□122MK40S		560	12.5×35	0.026	0.11	2,250	EKYB800E□□561MM20S
	1,200	16×25	0.024	0.096	2,750	EKYB500E□□122ML25S		560	18×20	0.032	0.13	2,100	EKYB800E□□561MM20S
	1,500	16×31.5	0.019	0.076	3,150	EKYB500E□□152MLN3S		680	12.5×40	0.024	0.096	2,450	EKYB800E□□681MK40S
	1,500	18×25	0.021	0.084	2,890	EKYB500E□□152MM25S		680	16×25	0.028	0.12	2,250	EKYB800E□□681ML25S
	1,800	16×35.5	0.016	0.064	3,550	EKYB500E□□182MLP1S		820	16×31.5	0.022	0.088	2,400	EKYB800E□□821MLN3S
	2,200	16×40	0.014	0.056	3,900	EKYB500E□□222ML40S		820	18×25	0.027	0.11	2,270	EKYB800E□□821MM25S
	2,200	18×31.5	0.014	0.056	3,800	EKYB500E□□222MMN3S		1,000	16×35.5	0.020	0.080	2,600	EKYB800E□□102MLP1S
	2,700	18×35.5	0.013	0.052	4,100	EKYB500E□□272MMP1S		1,200	16×40	0.018	0.072	2,900	EKYB800E□□122ML40S
63	18	5×11	0.50	2.0	220	EKYB630E□□180ME11D	1,200	18×31.5	0.020	0.080	2,550	EKYB800E□□122MMN3S	
	33	6.3×11	0.25	1.0	350	EKYB630E□□330MF11D	1,500	18×35.5	0.018	0.072	3,050	EKYB800E□□152MMP1S	
	56	8×11.5	0.16	0.64	530	EKYB630E□□560MHB5D	100	6.8	5×11	0.80	3.2	163	EKYB101E□□68RME11D
	82	8×15	0.12	0.48	700	EKYB630E□□820MH15D		15	6.3×11	0.43	1.8	267	EKYB101E□□150MF11D
	120	8×20	0.085	0.34	880	EKYB630E□□121MH20S		27	8×11.5	0.18	0.72	462	EKYB101E□□270MHB5D
	120	10×12.5	0.11	0.44	725	EKYB630E□□121MJC5S		39	8×15	0.14	0.56	585	EKYB101E□□390MH15D
	180	10×16	0.073	0.30	1,050	EKYB630E□□181MJ16S		56	8×20	0.11	0.44	735	EKYB101E□□560MH20D
	220	10×20	0.055	0.22	1,300	EKYB630E□□221MJ20S		56	10×12.5	0.14	0.56	624	EKYB101E□□560MJC5S
	330	10×25	0.045	0.18	1,550	EKYB630E□□331MJ25S		82	10×16	0.10	0.40	780	EKYB101E□□820MJ16S
	390	10×30	0.040	0.16	1,780	EKYB630E□□391MJ30S		100	10×20	0.075	0.30	1,040	EKYB101E□□101MJ20S
	390	12.5×20	0.036	0.15	1,780	EKYB630E□□391MK20S		120	10×25	0.060	0.24	1,170	EKYB101E□□121MJ25S
	560	12.5×25	0.030	0.12	2,100	EKYB630E□□561MK25S		150	10×30	0.053	0.22	1,350	EKYB101E□□151MJ30S
	680	12.5×30	0.026	0.11	2,415	EKYB630E□□681MK30S		180	12.5×20	0.048	0.20	1,430	EKYB101E□□181MK20S
	680	16×20	0.028	0.12	2,250	EKYB630E□□681ML20S		220	12.5×25	0.039	0.16	1,620	EKYB101E□□221MK25S
	820	12.5×35	0.022	0.088	2,700	EKYB630E□□821MK35S		270	12.5×30	0.033	0.14	1,950	EKYB101E□□271MK30S
	820	18×20	0.028	0.12	2,500	EKYB630E□□821MM20S		270	16×20	0.036	0.15	1,750	EKYB101E□□271ML20S
	1,000	12.5×40	0.020	0.080	3,000	EKYB630E□□102MK40S		330	16×25	0.028	0.12	2,250	EKYB101E□□331ML25S
	1,000	16×25	0.025	0.10	2,730	EKYB630E□□102ML25S		390	12.5×35	0.026	0.11	2,250	EKYB101E□□391MK35S
	1,200	16×31.5	0.020	0.080	3,000	EKYB630E□□122MLN3S		390	18×20	0.032	0.13	2,100	EKYB101E□□391MM20S
1,200	18×25	0.022	0.088	2,800	EKYB630E□□122MM25S	470		12.5×40	0.024	0.096	2,450	EKYB101E□□471MK40S	
1,500	16×35.5	0.018	0.072	3,200	EKYB630E□□152MLP1S	470		16×31.5	0.022	0.088	2,400	EKYB101E□□471MLN3S	
1,500	18×31.5	0.018	0.072	3,300	EKYB630E□□152MMN3S	560	16×35.5	0.020	0.080	2,600	EKYB101E□□561MLP1S		
1,800	16×40	0.016	0.064	3,590	EKYB630E□□182ML40S	560	18×25	0.027	0.11	2,270	EKYB101E□□561MM25S		
1,800	18×35.5	0.017	0.068	3,570	EKYB630E□□182MMP1S	680	16×40	0.018	0.072	2,900	EKYB101E□□681ML40S		
2,200	18×40	0.016	0.064	3,670	EKYB630E□□222MM40S	680	18×31.5	0.020	0.080	2,550	EKYB101E□□681MMN3S		
80	12	5×11	0.80	3.2	163	EKYB800E□□120ME11D	820	18×35.5	0.018	0.072	3,050	EKYB101E□□821MMP1S	
	22	6.3×11	0.43	1.8	267	EKYB800E□□220MF11D	1,000	18×40	0.017	0.068	3,510	EKYB101E□□102MM40S	
	39	8×11.5	0.18	0.72	462	EKYB800E□□390MHB5D							

□ □ : Enter the appropriate lead forming or taping code.

◆RATED RIPPLE CURRENT MULTIPLIERS

● Frequency Multipliers

Capacitance(μF)	Frequency(Hz)			
	120	1k	10k	100k
6.8 to 180	0.40	0.75	0.90	1.00
220 to 560	0.50	0.85	0.94	1.00
680 to 1,800	0.60	0.87	0.95	1.00
2,200 to 3,900	0.75	0.90	0.95	1.00
4,700 to	0.85	0.95	0.98	1.00

The endurance of capacitors is reduced with internal heating produced by ripple current at the rate of halving the lifetime with every 5°C rise. When long life performance is required in actual use, the rms ripple current has to be reduced.

Return Group Chart



MINIATURE ALUMINUM ELECTROLYTIC CAPACITORS

Low impedance, 105°C

KYA Series

- Downsized from KY series
- Newly innovative electrolyte is employed to minimize impedance
- Endurance with ripple current : 4,000 to 10,000 hours at 105°C
- Non solvent resistant type
- RoHS Compliant

KYA

↓
Downsized
↑
KY P172



SPECIFICATIONS

Items	Characteristics	
Category	-40 to +105°C	
Temperature Range		
Rated Voltage Range	6.3 to 100V _{dc}	
Capacitance Tolerance	±20% (M) (at 20°C, 120Hz)	
Leakage Current	I=0.01CV or 3μA, whichever is greater. Where, I : Max. leakage current (μA), C : Nominal capacitance (μF), V : Rated voltage (V) (at 20°C after 2 minutes)	
Dissipation Factor (tan δ)	Rated voltage (V _{dc})	6.3V 10V 16V 25V 35V 50V 63V 100V
	tan δ (Max.)	0.22 0.19 0.16 0.14 0.12 0.10 0.09 0.08
	When nominal capacitance exceeds 1,000μF, add 0.02 to the value above for each 1,000μF increase. (at 20°C, 120Hz)	
Low Temperature Characteristics (Max. Impedance Ratio)	Rated voltage (V _{dc})	6.3V 10V 16V 25V 35V 50V 63V 100V
	Z(-25°C)/Z(+20°C)	4 3 2 2 2 2 2 2
	Z(-40°C)/Z(+20°C)	8 6 4 3 3 3 3 3 (at 120Hz)
Endurance	The following specifications shall be satisfied when the capacitors are restored to 20°C after subjected to DC voltage with the rated ripple current is applied (the peak voltage shall not exceed the rated voltage) for the specified period of time at 105°C.	
	Time	6.3 to 10V _{dc} φ5 & 6.3 : 4,000hours φ8 & 10 : 6,000hours φ12.5 to 16 : 8,000hours 16 to 100V _{dc} φ5 & 6.3 : 5,000hours φ8 & 10 : 7,000hours φ12.5 to 16 : 10,000hours
	Capacitance change	≤ ±25% of the initial value
	D.F. (tan δ)	≤200% of the initial specified value
	Leakage current	≤The initial specified value
Shelf Life	The following specifications shall be satisfied when the capacitors are restored to 20°C after exposing them for 500 hours at 105°C without voltage applied. Before the measurement, the capacitor shall be preconditioned by applying voltage according to Item 4.1 of JIS C 5101-4.	
	Capacitance change	≤ ±25% of the initial value
	D.F. (tan δ)	≤200% of the initial specified value
	Leakage current	≤The initial specified value

DIMENSIONS [mm]

Terminal Code : E

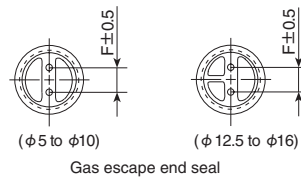
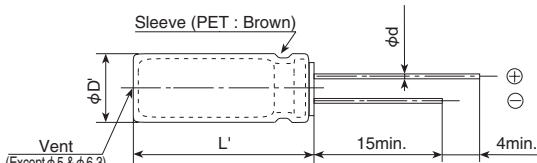

φD	5	6.3	8	10	12.5	16
φd	0.5	0.5	0.6	0.6	0.6	0.8
F	2.0	2.5	3.5	5.0	5.0	7.5
φD'	φD+0.5max.					
L'	L+1.5max.					

PART NUMBERING SYSTEM

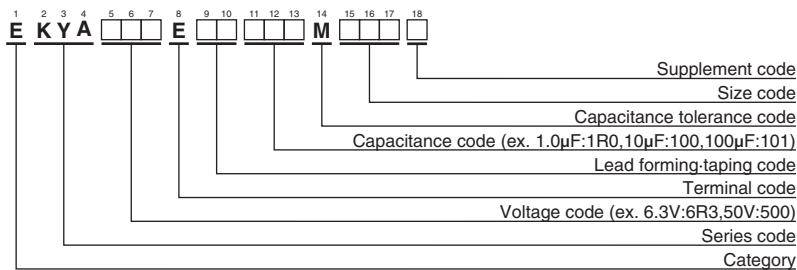

Please refer to "Product code guide (radial lead type)"



KYA Series

◆ STANDARD RATINGS

WV (V _{dc})	Cap (μF)	Case size φD×L(mm)	Impedance (Ω max./100kHz)		Rated ripple current (mA _{rms} / 105°C, 100kHz)	Part No.
			20°C	-10°C		
100	10	6.3×11	0.57	2.3	205	EKYA101E□□100MF11D
	15	6.3×11	0.57	2.3	205	EKYA101E□□150MF11D
	27	8×11.5	0.36	1.4	355	EKYA101E□□270MHB5D
	39	8×15	0.25	1.0	450	EKYA101E□□390MH15D
	47	10×12.5	0.17	0.66	480	EKYA101E□□470MJC5S
	56	8×20	0.19	0.76	565	EKYA101E□□560MH20D
	68	10×16	0.11	0.47	600	EKYA101E□□680MJ16S
	100	10×20	0.084	0.34	800	EKYA101E□□101MJ20S
	150	10×25	0.069	0.28	900	EKYA101E□□151MJ25S
	180	12.5×20	0.062	0.18	1,100	EKYA101E□□181MK20S
	220	12.5×25	0.047	0.14	1,250	EKYA101E□□221MK25S
	330	16×25	0.038	0.12	1,700	EKYA101E□□331ML25S
	470	16×31.5	0.032	0.095	1,850	EKYA101E□□471MLN3S
	560	16×35.5	0.029	0.086	2,000	EKYA101E□□561MLP1S

□□ : Enter the appropriate lead forming or taping code.

◆ RATED RIPPLE CURRENT MULTIPLIERS

⊙ Frequency Multipliers

Capacitance(μF)	Frequency(Hz)			
	120	1k	10k	100k
1.0 to 180	0.40	0.75	0.90	1.00
220 to 560	0.50	0.85	0.94	1.00
680 to 1,800	0.60	0.87	0.95	1.00
2,200 to 3,900	0.75	0.90	0.95	1.00
4,700 to	0.85	0.95	0.98	1.00

The endurance of capacitors is reduced with internal heating produced by ripple current at the rate of halving the lifetime with every 5°C rise. When long life performance is required in actual use, the rms ripple current has to be reduced.

Return Group Chart



MINIATURE ALUMINUM ELECTROLYTIC CAPACITORS

Low impedance, 105°C

KY Series

- Newly innovative electrolyte is employed to minimize ESR
- Endurance with ripple current : 4,000 to 10,000 hours at 105°C
- Non solvent resistant type
- RoHS Compliant

KZH P161
↑ Lower Z
KZE P163
↑ Lower Z
KY



◆ SPECIFICATIONS

Items	Characteristics										
Category	-40 to +105°C										
Temperature Range	-40 to +105°C										
Rated Voltage Range	6.3 to 100V _{dc}										
Capacitance Tolerance	±20% (M) (at 20°C, 120Hz)										
Leakage Current	I=0.01CV or 3μA, whichever is greater. Where, I : Max. leakage current (μA), C : Nominal capacitance (μF), V : Rated voltage (V) (at 20°C after 2 minutes)										
Dissipation Factor (tan δ)	Rated voltage (V _{dc})	6.3V	10V	16V	25V	35V	50V	63V	80V	100V	
	tan δ (Max.)	0.22	0.19	0.16	0.14	0.12	0.10	0.09	0.09	0.08	
	When nominal capacitance exceeds 1,000μF, add 0.02 to the value above for each 1,000μF increase. (at 20°C, 120Hz)										
Low Temperature Characteristics (Max. Impedance Ratio)	Rated voltage (V _{dc})	6.3V	10V	16V	25V	35V	50V	63V	80V	100V	
	Z(-25°C)/Z(+20°C)	4	3	2	2	2	2	2	2	2	
	Z(-40°C)/Z(+20°C)	8	6	4	3	3	3	3	3	3	
(at 120Hz)											
Endurance	The following specifications shall be satisfied when the capacitors are restored to 20°C after subjected to DC voltage with the rated ripple current is applied (the peak voltage shall not exceed the rated voltage) for the specified period of time at 105°C.										
	Time	6.3 to 10V _{dc}	φ 5 & 6.3 : 4,000hours		φ 8 & 10 : 6,000hours		φ 12.5 to 18 : 8,000hours				
		16 to 100V _{dc}	φ 5 & 6.3 : 5,000hours		φ 8 & 10 : 7,000hours		φ 12.5 to 18 : 10,000hours				
	Capacitance change	≤ ±25% of the initial value									
	D.F. (tan δ)	≤ 200% of the initial specified value									
Leakage current	≤ The initial specified value										
Shelf Life	The following specifications shall be satisfied when the capacitors are restored to 20°C after exposing them for 500 hours at 105°C without voltage applied. Before the measurement, the capacitor shall be preconditioned by applying voltage according to Item 4.1 of JIS C 5101-4.										
	Capacitance change	≤ ±25% of the initial value									
	D.F. (tan δ)	≤ 200% of the initial specified value									
	Leakage current	≤ The initial specified value									

◆ DIMENSIONS [mm]

● Terminal Code : E

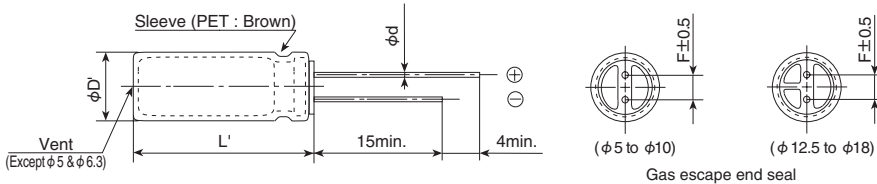

φD	5	6.3	8	10	12.5	16	18
φd	0.5	0.5	0.6	0.6	0.6	0.8	0.8
F	2.0	2.5	3.5	5.0	5.0	7.5	7.5
φD'	φD+0.5max.						
L'	L+1.5max.						

◆ PART NUMBERING SYSTEM

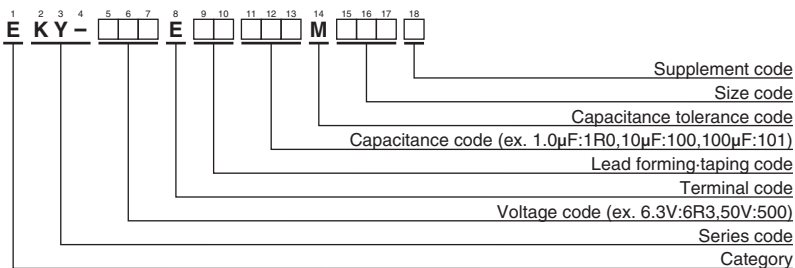

Please refer to "Product code guide (radial lead type)"

Return Group Chart



MINIATURE ALUMINUM ELECTROLYTIC CAPACITORS

Low impedance, 105°C

KY Series

◆ STANDARD RATINGS

VV (V _{dc})	Cap (μF)	Case size φD×L(mm)	Impedance (Ω max./100kHz)		Rated ripple current (mA _{rms} /105°C, 100kHz)	Part No.	VV (V _{dc})	Cap (μF)	Case size φD×L(mm)	Impedance (Ω max./100kHz)		Rated ripple current (mA _{rms} /105°C, 100kHz)	Part No.
			20°C	-10°C						20°C	-10°C		
35	2,200	18×25	0.019	0.049	3,140	EKY-350E□□222MM25S	63	680	16×25	0.025	0.075	2,600	EKY-630E□□681ML25S
	2,700	16×35.5	0.015	0.044	3,610	EKY-350E□□272MLP1S		680	18×20	0.030	0.090	2,500	EKY-630E□□681MM20S
	2,700	18×31.5	0.015	0.040	4,170	EKY-350E□□272MMN3S		820	16×31.5	0.021	0.063	2,850	EKY-630E□□821MLN3S
	3,300	16×40	0.013	0.038	4,080	EKY-350E□□332ML40S		820	18×25	0.024	0.072	2,800	EKY-630E□□821MM25S
	3,300	18×35.5	0.014	0.038	4,220	EKY-350E□□332MMP1S		1,000	16×35.5	0.019	0.057	2,900	EKY-630E□□102MLP1S
	3,900	18×40	0.012	0.032	4,280	EKY-350E□□392MM40S		1,200	16×40	0.018	0.054	3,400	EKY-630E□□122ML40S
50	1.0	5×11	4.0	16.0	30	EKY-500E□□1R0ME11D	80	1,200	18×31.5	0.020	0.060	3,300	EKY-630E□□121MMN3S
	2.2	5×11	2.5	10.0	43	EKY-500E□□2R2ME11D		1,500	18×35.5	0.018	0.054	3,400	EKY-630E□□152MMP1S
	3.3	5×11	2.2	8.8	53	EKY-500E□□3R3ME11D		1,800	18×40	0.017	0.051	3,500	EKY-630E□□182MM40S
	4.7	5×11	1.9	7.6	88	EKY-500E□□4R7ME11D		68	10×12.5	0.17	0.66	480	EKY-800E□□680MJCS5
	10	5×11	1.5	6.0	100	EKY-500E□□100ME11D		100	10×16	0.11	0.47	600	EKY-800E□□101MJ16S
	22	5×11	0.70	2.8	180	EKY-500E□□220ME11D		120	10×20	0.084	0.34	800	EKY-800E□□121MJ20S
	56	6.3×11	0.30	1.2	295	EKY-500E□□560MF11D		150	10×25	0.069	0.28	900	EKY-800E□□151MJ25S
	100	8×11.5	0.17	0.68	555	EKY-500E□□101MHB5D		150	12.5×16	0.11	0.34	750	EKY-800E□□151MK16S
	120	8×15	0.12	0.48	730	EKY-500E□□121MH15D		220	12.5×20	0.062	0.18	1,100	EKY-800E□□221MK20S
	150	10×12.5	0.12	0.48	760	EKY-500E□□151MJCS5		330	12.5×25	0.047	0.14	1,250	EKY-800E□□331MK25S
	180	8×20	0.091	0.36	910	EKY-500E□□181MH20D		330	16×20	0.048	0.15	1,350	EKY-800E□□331ML20S
	220	10×16	0.084	0.34	1,050	EKY-500E□□221MJ16S		390	12.5×30	0.042	0.13	1,500	EKY-800E□□391MK30S
	270	10×20	0.060	0.24	1,220	EKY-500E□□271MJ20S		470	12.5×35	0.036	0.11	1,650	EKY-800E□□471MK35S
	270	12.5×15	0.061	0.20	1,260	EKY-500E□□271MK15S		470	16×25	0.038	0.12	1,700	EKY-800E□□471ML25S
	330	10×25	0.055	0.22	1,440	EKY-500E□□331MJ25S		470	18×20	0.045	0.14	1,500	EKY-800E□□471MM20S
	470	10×30	0.043	0.17	1,690	EKY-500E□□471MJ30S		560	12.5×40	0.032	0.095	1,800	EKY-800E□□561MK40S
	470	12.5×20	0.045	0.15	1,660	EKY-500E□□471MK20S		680	16×31.5	0.032	0.095	1,850	EKY-800E□□681MLN3S
	470	16×15	0.055	0.17	1,690	EKY-500E□□471ML15S		680	18×25	0.036	0.11	1,750	EKY-800E□□681MM25S
	560	12.5×25	0.034	0.11	1,950	EKY-500E□□561MK25S		820	16×35.5	0.029	0.086	2,000	EKY-800E□□821MLP1S
	560	18×15	0.054	0.15	1,930	EKY-500E□□561MM15S		820	18×31.5	0.030	0.090	1,900	EKY-800E□□821MMN3S
	680	12.5×30	0.030	0.10	2,310	EKY-500E□□681MK30S		1,000	16×40	0.027	0.081	2,200	EKY-800E□□102ML40S
820	12.5×35	0.025	0.083	2,510	EKY-500E□□821MK35S	1,000	18×35.5	0.027	0.081	2,200	EKY-800E□□102MMP1S		
820	16×20	0.034	0.10	2,210	EKY-500E□□821ML20S	1,200	18×40	0.026	0.077	2,700	EKY-800E□□122MM40S		
1,000	12.5×40	0.021	0.069	2,920	EKY-500E□□102MK40S	6.8	5×11	1.4	5.6	125	EKY-101E□□6R8ME11D		
1,000	16×25	0.025	0.075	2,555	EKY-500E□□102ML25S	15	6.3×11	0.57	2.3	205	EKY-101E□□150MF11D		
1,000	18×20	0.036	0.097	2,490	EKY-500E□□102MM20S	27	8×11.5	0.36	1.4	355	EKY-101E□□270MHB5D		
1,200	16×31.5	0.022	0.066	3,010	EKY-500E□□122MLN3S	39	8×15	0.25	1.0	450	EKY-101E□□390MH15D		
1,200	18×25	0.026	0.070	2,740	EKY-500E□□122MM25S	47	10×12.5	0.17	0.66	480	EKY-101E□□470MJCS5		
1,500	16×35.5	0.019	0.057	3,150	EKY-500E□□152MLP1S	56	8×20	0.19	0.76	565	EKY-101E□□560MH20D		
1,800	16×40	0.016	0.048	3,710	EKY-500E□□182ML40S	68	10×16	0.11	0.47	600	EKY-101E□□680MJ16S		
1,800	18×31.5	0.021	0.057	3,635	EKY-500E□□182MMN3S	82	10×20	0.084	0.34	800	EKY-101E□□820MJ20S		
2,200	18×35.5	0.017	0.046	3,680	EKY-500E□□222MMP1S	100	12.5×16	0.11	0.34	750	EKY-101E□□101MK16S		
2,700	18×40	0.014	0.038	3,800	EKY-500E□□272MM40S	120	10×25	0.069	0.28	900	EKY-101E□□121MJ25S		
63	15	5×11	0.88	3.5	165	EKY-630E□□150ME11D	150	12.5×20	0.062	0.18	1,100	EKY-101E□□151MK20S	
	33	6.3×11	0.35	1.4	265	EKY-630E□□330MF11D	220	12.5×25	0.047	0.14	1,250	EKY-101E□□221MK25S	
	56	8×11.5	0.22	0.88	500	EKY-630E□□560MHB5D	220	16×20	0.048	0.15	1,350	EKY-101E□□221ML20S	
	82	8×15	0.16	0.64	665	EKY-630E□□820MH15D	270	12.5×30	0.042	0.13	1,500	EKY-101E□□271MK30S	
	82	10×12.5	0.11	0.44	690	EKY-630E□□820MJCS5	330	12.5×35	0.036	0.11	1,650	EKY-101E□□331MK35S	
	120	8×20	0.12	0.48	820	EKY-630E□□121MH20D	330	16×25	0.038	0.12	1,700	EKY-101E□□331ML25S	
	120	10×16	0.076	0.31	950	EKY-630E□□121MJ16S	330	18×20	0.045	0.14	1,500	EKY-101E□□331MM20S	
	180	10×20	0.056	0.23	1,150	EKY-630E□□181MJ20S	390	12.5×40	0.032	0.095	1,800	EKY-101E□□391MK40S	
	180	12.5×16	0.072	0.29	1,150	EKY-630E□□181MK16S	470	16×31.5	0.032	0.095	1,850	EKY-101E□□471MLN3S	
	220	10×25	0.046	0.19	1,350	EKY-630E□□221MJ25S	470	18×25	0.036	0.11	1,750	EKY-101E□□471MM25S	
	270	12.5×20	0.041	0.13	1,500	EKY-630E□□271MK20S	560	16×35.5	0.029	0.086	2,000	EKY-101E□□561MLP1S	
	390	12.5×25	0.031	0.093	1,900	EKY-630E□□391MK25S	560	18×31.5	0.030	0.090	1,900	EKY-101E□□561MMN3S	
	470	12.5×30	0.028	0.084	2,300	EKY-630E□□471MK30S	680	16×40	0.027	0.081	2,200	EKY-101E□□681ML40S	
	470	16×20	0.032	0.096	2,000	EKY-630E□□471ML20S	680	18×35.5	0.027	0.081	2,200	EKY-101E□□681MMP1S	
	560	12.5×35	0.024	0.072	2,500	EKY-630E□□561MK35S	820	18×40	0.026	0.077	2,700	EKY-101E□□821MM40S	
	680	12.5×40	0.021	0.063	2,800	EKY-630E□□681MK40S							

□ □ : Enter the appropriate lead forming or taping code.

◆ RATED RIPPLE CURRENT MULTIPLIERS

● Frequency Multipliers

Capacitance(μF)	Frequency(Hz)	120	1k	10k	100k
1.0 to 180	120	0.40	0.75	0.90	1.00
	1k	0.40	0.75	0.90	1.00
220 to 560	120	0.50	0.85	0.94	1.00
	1k	0.50	0.85	0.94	1.00
680 to 1,800	120	0.60	0.87	0.95	1.00
	1k	0.60	0.87	0.95	1.00
2,200 to 3,900	120	0.75	0.90	0.95	1.00
	1k	0.75	0.90	0.95	1.00
4,700 to	120	0.85	0.95	0.98	1.00
	1k	0.85	0.95	0.98	1.00

The endurance of capacitors is reduced with internal heating produced by ripple current at the rate of halving the lifetime with every 5°C rise.
When long life performance is required in actual use, the rms ripple current has to be reduced.

Return Group Chart



MINIATURE ALUMINUM ELECTROLYTIC CAPACITORS

Low impedance, Downsized, 105°C

LZA Series

- Adoption of innovative electrolyte and new technologies
- Very low impedance at high frequency
- Endurance with ripple current: 4,000 to 7,000 hours at 105°C
- Solvent resistant type (see PRECAUTIONS AND GUIDELINES)
- RoHS Compliant
- AEC-Q200 compliant : Please contact Chemi-Con for more details, test data, information.

LZA

↑ Lower Z
Downsized
LXZ P177



◆ SPECIFICATIONS

Items	Characteristics						
Category	-55 to +105°C						
Temperature Range	-55 to +105°C						
Rated Voltage Range	6.3 to 35V _{dc}						
Capacitance Tolerance	±20% (M) (at 20°C, 120Hz)						
Leakage Current	I=0.01CV or 3µA, whichever is greater. Where, I : Max. leakage current (µA), C : Nominal capacitance (µF), V : Rated voltage (V) (at 20°C after 2 minutes)						
Dissipation Factor (tan δ)	Rated voltage (V _{dc})	6.3V	10V	16V	25V	35V	
	tan δ (Max.)	0.22	0.19	0.16	0.14	0.12	
	When nominal capacitance exceeds 1,000µF, add 0.02 to the value above for each 1,000µF increase. (at 20°C, 120Hz)						
Low Temperature Characteristics (Max. Impedance Ratio)	Rated voltage (V _{dc})	6.3V	10V	16V	25V	35V	
	Z(-55°C)/Z(+20°C)	4	3	3	3	3	
(at 120Hz)							
Endurance	The following specifications shall be satisfied when the capacitors are restored to 20°C after subjected to DC voltage with the rated ripple current is applied (the peak voltage shall not exceed the rated voltage) for the specified period of time at 105°C.						
	Time	φ 10 : 4,000hours		φ 12.5 : 5,000hours		φ 16 to φ 18 : 7,000hours	
	Rated voltage	6.3 to 10V _{dc} (φ 10)			6.3 to 10V _{dc} (φ 12.5 to φ 18)		16 to 35V _{dc}
	Capacitance change	≤ ±30% of the initial value			≤ ±20% of the initial value		≤ ±20% of the initial value
	D.F.(tan δ)	≤300% of the initial specified value			≤200% of the initial specified value		≤200% of the initial specified value
	Leakage current	≤The initial specified value			≤The initial specified value		≤The initial specified value
	The following specifications shall be satisfied when the capacitors are restored to 20°C after exposing them for 1,000 hours at 105°C without voltage applied. Before the measurement, the capacitor shall be preconditioned by applying voltage according to Item 4.1 of JIS C 5101-4.						
Shelf Life	Rated voltage	6.3 to 10V _{dc} (φ 10)			6.3 to 10V _{dc} (φ 12.5 to φ 18)		16 to 35V _{dc}
	Capacitance change	≤ ±30% of the initial value			≤ ±20% of the initial value		≤ ±20% of the initial value
	D.F.(tan δ)	≤300% of the initial specified value			≤200% of the initial specified value		≤200% of the initial specified value
	Leakage current	≤The initial specified value			≤The initial specified value		≤The initial specified value

◆ DIMENSIONS [mm]

● Terminal Code : E

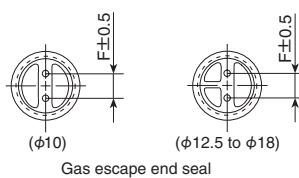
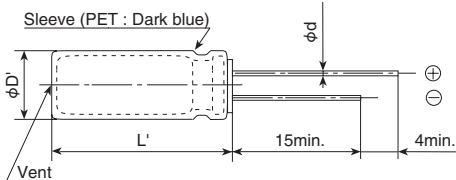

φD	10	12.5	16	18
φd	0.6	0.6	0.8	0.8
F	5.0	5.0	7.5	7.5
φD'	φD+0.5max.			
L'	L+1.5max.			

◆ PART NUMBERING SYSTEM

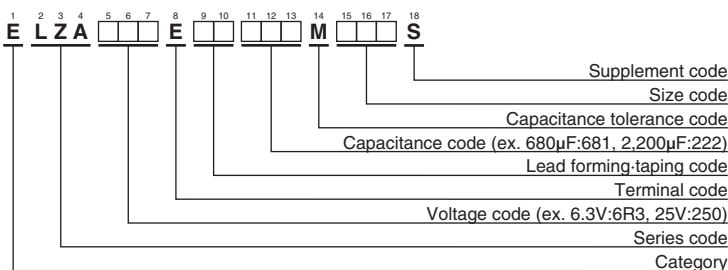

Please refer to "Product code guide (radial lead type)"

Return Group Chart



MINIATURE ALUMINUM ELECTROLYTIC CAPACITORS

Low impedance, Downsized, 105°C

LZA Series

◆STANDARD RATINGS

WV (V _{dc})	Cap (μF)	Case size φD×L(mm)	Impedance (Ω max./20°C, 100kHz)	Rated ripple current (mA _{rms} /105°C, 100kHz)	Part No.	WV (V _{dc})	Cap (μF)	Case size φD×L(mm)	Impedance (Ω max./20°C, 100kHz)	Rated ripple current (mA _{rms} /105°C, 100kHz)	Part No.	
6.3	1,500	10 × 12.5	0.063	960	ELZA6R3E□□152MJC5S	16	3,300	12.5 × 25	0.022	2,350	ELZA160E□□332MK25S	
	1,800	10 × 16	0.049	1,240	ELZA6R3E□□182MJ16S		3,900	16 × 20	0.026	2,330	ELZA160E□□392ML20S	
	2,700	10 × 20	0.035	1,550	ELZA6R3E□□272MJ20S		5,600	16 × 25	0.019	2,760	ELZA160E□□562ML25S	
	3,300	10 × 25	0.033	1,740	ELZA6R3E□□332MJ25S		5,600	18 × 20	0.025	2,640	ELZA160E□□562MM20S	
	4,700	12.5 × 20	0.029	1,890	ELZA6R3E□□472MK20S		8,200	18 × 25	0.018	2,850	ELZA160E□□822MM25S	
	6,800	12.5 × 25	0.022	2,350	ELZA6R3E□□682MK25S		25	470	10 × 12.5	0.063	960	ELZA250E□□471MJC5S
	6,800	16 × 20	0.026	2,330	ELZA6R3E□□682ML20S			680	10 × 16	0.049	1,240	ELZA250E□□681MJ16S
	8,200	18 × 20	0.025	2,640	ELZA6R3E□□822MM20S			1,000	10 × 20	0.035	1,550	ELZA250E□□102MJ20S
	10,000	16 × 25	0.019	2,760	ELZA6R3E□□103ML25S			1,200	10 × 25	0.033	1,740	ELZA250E□□122MJ25S
	12,000	18 × 25	0.018	2,850	ELZA6R3E□□123MM25S			1,500	12.5 × 20	0.029	1,890	ELZA250E□□152MK20S
10	1,000	10 × 12.5	0.063	960	ELZA100E□□102MJC5S	2,200		12.5 × 25	0.022	2,350	ELZA250E□□222MK25S	
	1,500	10 × 16	0.049	1,240	ELZA100E□□152MJ16S	2,700		16 × 20	0.026	2,330	ELZA250E□□272ML20S	
	2,200	10 × 20	0.035	1,550	ELZA100E□□222MJ20S	3,300		18 × 20	0.025	2,640	ELZA250E□□332MM20S	
	2,700	10 × 25	0.033	1,740	ELZA100E□□272MJ25S	3,900		16 × 25	0.019	2,760	ELZA250E□□392ML25S	
	3,300	12.5 × 20	0.029	1,890	ELZA100E□□332MK20S	4,700		18 × 25	0.018	2,850	ELZA250E□□472MM25S	
	4,700	12.5 × 25	0.022	2,350	ELZA100E□□472MK25S	35	330	10 × 12.5	0.063	960	ELZA350E□□331MJC5S	
	4,700	16 × 20	0.026	2,330	ELZA100E□□472ML20S		470	10 × 16	0.049	1,240	ELZA350E□□471MJ16S	
	6,800	16 × 25	0.019	2,760	ELZA100E□□682ML25S		680	10 × 20	0.035	1,550	ELZA350E□□681MJ20S	
	6,800	18 × 20	0.025	2,640	ELZA100E□□682MM20S		820	10 × 25	0.033	1,740	ELZA350E□□821MJ25S	
	8,200	18 × 25	0.018	2,850	ELZA100E□□822MM25S		1,000	12.5 × 20	0.029	1,890	ELZA350E□□102MK20S	
16	820	10 × 12.5	0.063	960	ELZA160E□□821MJC5S		1,500	12.5 × 25	0.022	2,350	ELZA350E□□152MK25S	
	1,000	10 × 16	0.049	1,240	ELZA160E□□102MJ16S		1,800	16 × 20	0.026	2,330	ELZA350E□□182ML20S	
	1,500	10 × 20	0.035	1,550	ELZA160E□□152MJ20S		2,200	18 × 20	0.025	2,640	ELZA350E□□222MM20S	
	1,800	10 × 25	0.033	1,740	ELZA160E□□182MJ25S		2,700	16 × 25	0.019	2,760	ELZA350E□□272ML25S	
	2,200	12.5 × 20	0.029	1,890	ELZA160E□□222MK20S		3,300	18 × 25	0.018	2,850	ELZA350E□□332MM25S	

□ □ : Enter the appropriate lead forming or taping code.

◆RATED RIPPLE CURRENT MULTIPLIERS

● Frequency Multipliers

Capacitance(μF)	Frequency(Hz)			
	120	1k	10k	100k
330 to 470	0.50	0.85	0.94	1.00
680 to 1,800	0.60	0.87	0.95	1.00
2,200 to 3,900	0.75	0.90	0.95	1.00
4,700 to 12,000	0.85	0.95	0.98	1.00

The endurance of capacitors is reduced with internal heating produced by ripple current at the rate of halving the lifetime with every 5°C rise. When long life performance is required in actual use, the rms ripple current has to be reduced.

Return Group Chart



MINIATURE ALUMINUM ELECTROLYTIC CAPACITORS

Low impedance, Downsized, 105°C

LXZ Series

- Adoption of innovative electrolyte and new technologies
- Very low impedance at high frequency
- Endurance with ripple current: 2,000 to 8,000 hours at 105°C
- Solvent resistant type (see PRECAUTIONS AND GUIDELINES)
- RoHS Compliant
- AEC-Q200 compliant : Please contact Chemi-Con for more details, test data, information.

LXZ

↑ Lower Z
Downsized
LXY P180
↑ Lower Z
LXV P182



◆ SPECIFICATIONS

Items	Characteristics	
Category	-55 to +105°C	
Temperature Range		
Rated Voltage Range	6.3 to 63V _{dc}	
Capacitance Tolerance	±20% (M) (at 20°C, 120Hz)	
Leakage Current	I=0.01CV or 3μA, whichever is greater. Where, I : Max. leakage current (μA), C : Nominal capacitance (μF), V : Rated voltage (V) (at 20°C after 2 minutes)	
Dissipation Factor (tan δ)	Rated voltage (V _{dc})	6.3V 10V 16V 25V 35V 50V 63V
	tan δ (Max.)	0.22 0.19 0.16 0.14 0.12 0.10 0.08
	When nominal capacitance exceeds 1,000μF, add 0.02 to the value above for each 1,000μF increase. (at 20°C, 120Hz)	
Endurance	The following specifications shall be satisfied when the capacitors are restored to 20°C after subjected to DC voltage with the rated ripple current is applied (the peak voltage shall not exceed the rated voltage) for the specified period of time at 105°C.	
	Time	φ5 & 6.3 : 2,000hours φ8 : 3,000hours φ10 : 5,000hours φ12.5 : 7,000hours φ16 & 18 : 8,000hours
	Capacitance change	≤ ±20% of the initial value
	D.F. (tan δ)	≤ 200% of the initial specified value
Shelf Life	The following specifications shall be satisfied when the capacitors are restored to 20°C after exposing them for 1,000 hours at 105°C without voltage applied. Before the measurement, the capacitor shall be preconditioned by applying voltage according to Item 4.1 of JIS C 5101-4.	
	Capacitance change	≤ ±20% of the initial value
	D.F. (tan δ)	≤ 200% of the initial specified value
	Leakage current	≤ The initial specified value

◆ DIMENSIONS [mm]

● Terminal Code : E

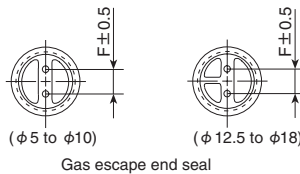
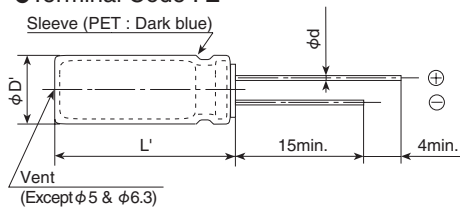

φD	5	6.3	8	10	12.5	16	18
φd	0.5	0.5	0.6	0.6	0.6	0.8	0.8
F	2.0	2.5	3.5	5.0	5.0	7.5	7.5
φD'	φD+0.5max.						
L'	L+1.5max.						

◆ PART NUMBERING SYSTEM

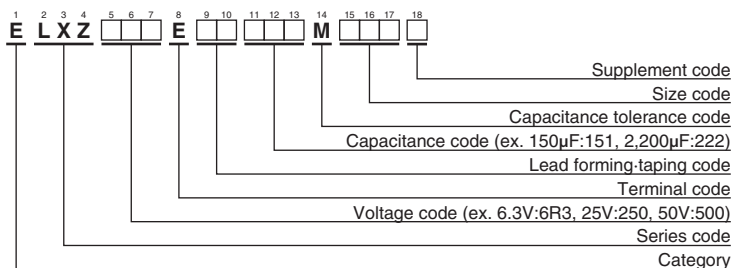

Please refer to "Product code guide (radial lead type)"

Return Group Chart



MINIATURE ALUMINUM ELECTROLYTIC CAPACITORS

Low impedance, Downsized, 105°C

LXZ Series

◆STANDARD RATINGS

WV (V _{dc})	Cap (μF)	Case size φD×L(mm)	Impedance (Ω max./100kHz)		Rated ripple current (mA _{rms} / 105°C, 100kHz)	Part No.	WV (V _{dc})	Cap (μF)	Case size φD×L(mm)	Impedance (Ω max./100kHz)		Rated ripple current (mA _{rms} / 105°C, 100kHz)	Part No.
			20°C	-10°C						20°C	-10°C		
50	120	8×15	0.16	0.32	635	ELXZ500E□□121MH15D	63	39	6.3×15	0.61	1.4	330	ELXZ630E□□390MF15D
	120	10×12.5	0.16	0.32	620	ELXZ500E□□121MJC5S		68	8×12	0.34	0.75	405	ELXZ630E□□680MH12D
	180	8×20	0.12	0.24	730	ELXZ500E□□181MH20D		100	8×15	0.27	0.65	535	ELXZ630E□□101MH15D
	180	10×16	0.13	0.26	850	ELXZ500E□□181MJ16S		100	10×12.5	0.255	0.51	540	ELXZ630E□□101MJC5S
	220	10×20	0.088	0.18	1,050	ELXZ500E□□221MJ20S		120	10×16	0.19	0.38	600	ELXZ630E□□121MJ16S
	330	10×25	0.073	0.15	1,250	ELXZ500E□□331MJ25S		150	8×20	0.21	0.52	690	ELXZ630E□□151MH20D
	390	10×30	0.054	0.11	1,500	ELXZ500E□□391MJ30S		180	10×20	0.145	0.29	890	ELXZ630E□□181MJ20S
	390	12.5×20	0.059	0.12	1,480	ELXZ500E□□391MK20S		220	10×25	0.13	0.26	1,050	ELXZ630E□□221MJ25S
	560	12.5×25	0.044	0.088	1,840	ELXZ500E□□561MK25S		330	10×30	0.090	0.18	1,300	ELXZ630E□□331MJ30S
	680	12.5×30	0.039	0.078	2,220	ELXZ500E□□681MK30S		330	12.5×20	0.085	0.17	1,290	ELXZ630E□□331MK20S
	680	16×20	0.048	0.096	1,840	ELXZ500E□□681ML20S		390	12.5×25	0.070	0.14	1,720	ELXZ630E□□391MK25S
	820	12.5×35	0.033	0.066	2,290	ELXZ500E□□821MK35S		470	12.5×30	0.055	0.11	2,090	ELXZ630E□□471MK30S
	820	18×20	0.042	0.084	1,980	ELXZ500E□□821MM20S		470	16×20	0.059	0.12	1,770	ELXZ630E□□471ML20S
	1,000	12.5×40	0.029	0.058	2,500	ELXZ500E□□102MK40S		680	12.5×35	0.047	0.094	2,270	ELXZ630E□□681MK35S
	1,000	16×25	0.034	0.068	2,240	ELXZ500E□□102ML25S		680	16×25	0.050	0.10	2,160	ELXZ630E□□681ML25S
	1,200	16×30	0.028	0.056	2,700	ELXZ500E□□122ML30S		680	18×20	0.055	0.11	2,290	ELXZ630E□□681MM20S
	1,200	18×25	0.029	0.058	2,610	ELXZ500E□□122MM25S		820	12.5×40	0.042	0.084	2,560	ELXZ630E□□821MK40S
	1,500	16×35	0.025	0.050	2,800	ELXZ500E□□152ML35S		820	16×30	0.043	0.086	2,670	ELXZ630E□□821ML30S
	1,800	16×40	0.021	0.042	3,200	ELXZ500E□□182ML40S		820	18×25	0.043	0.086	2,590	ELXZ630E□□821MM25S
	1,800	18×30	0.025	0.050	3,000	ELXZ500E□□182MM30S		1,000	16×35	0.036	0.072	2,770	ELXZ630E□□102ML35S
2,200	18×35	0.023	0.046	3,100	ELXZ500E□□222MM35S	1,200	16×40	0.030	0.060	2,850	ELXZ630E□□122ML40S		
2,700	18×40	0.020	0.040	3,400	ELXZ500E□□272MM40S	1,200	18×30	0.032	0.064	2,950	ELXZ630E□□122MM30S		
63	12	5×11.5	1.9	4.0	145	ELXZ630E□□120MEB5D	1,500	18×35	0.030	0.060	3,100	ELXZ630E□□152MM35S	
	22	6.3×11.5	1.0	2.0	240	ELXZ630E□□220MFB5D	1,800	18×40	0.025	0.050	3,210	ELXZ630E□□182MM40S	

□□ : Enter the appropriate lead forming or taping code.

◆RATED RIPPLE CURRENT MULTIPLIERS

● Frequency Multipliers

Capacitance(μF)	Frequency(Hz)			
	120	1k	10k	100k
12 to 180	0.40	0.75	0.90	1.00
220 to 560	0.50	0.85	0.94	1.00
680 to 1,800	0.60	0.87	0.95	1.00
2,200 to 3,900	0.75	0.90	0.95	1.00
4,700 to 18,000	0.85	0.95	0.98	1.00

The endurance of capacitors is reduced with internal heating produced by ripple current at the rate of halving the lifetime with every 5°C rise. When long life performance is required in actual use, the rms ripple current has to be reduced.

Return Group Chart



MINIATURE ALUMINUM ELECTROLYTIC CAPACITORS

Low impedance, 105°C

LXY Series

- Adoption of innovative electrolyte and new technologies
- Endurance with ripple current : 2,000 to 8,000 hours at 105°C
- Solvent resistant type (see PRECAUTIONS AND GUIDELINES)
- RoHS Compliant
- AEC-Q200 compliant : Please contact Chemi-Con for more details, test data, information.



SPECIFICATIONS

Items	Characteristics	
Category	-55 to +105°C	
Temperature Range		
Rated Voltage Range	10 to 63V _{dc}	
Capacitance Tolerance	±20% (M) (at 20°C, 120Hz)	
Leakage Current	I=0.01CV or 3μA, whichever is greater. Where, I : Max. leakage current (μA), C : Nominal capacitance (μF), V : Rated voltage (V) (at 20°C after 2 minutes)	
Dissipation Factor (tan δ)	Rated voltage (V _{dc})	10V 16V 25V 35V 50V 63V
	tan δ (Max.)	0.19 0.16 0.14 0.12 0.10 0.10
	When nominal capacitance exceeds 1,000μF, add 0.02 to the value above for each 1,000μF increase. (at 20°C, 120Hz)	
Low Temperature Characteristics (Max. Impedance Ratio)	Z(-55°C)/Z(+20°C)	10 to 50V _{dc} : 3max. 63V _{dc} : 6max.
	(at 120Hz)	
Endurance	The following specifications shall be satisfied when the capacitors are restored to 20°C after subjected to DC voltage with the rated ripple current is applied (the peak voltage shall not exceed the rated voltage) for the specified period of time at 105°C.	
	Time	φ 5 & 6.3 : 2,000hours φ 8 : 3,000hours φ 10 : 5,000hours φ 12.5 : 7,000hours φ 16 & 18 : 8,000hours
	Capacitance change	≤ ±20% of the initial value
	D.F. (tan δ)	≤200% of the initial specified value
	Leakage current	≤The initial specified value
Shelf Life	The following specifications shall be satisfied when the capacitors are restored to 20°C after exposing them for 1,000 hours at 105°C without voltage applied. Before the measurement, the capacitor shall be preconditioned by applying voltage according to Item 4.1 of JIS C 5101-4.	
	Capacitance change	≤ ±20% of the initial value
	D.F. (tan δ)	≤200% of the initial specified value
	Leakage current	≤The initial specified value

DIMENSIONS [mm]

- Terminal Code : E

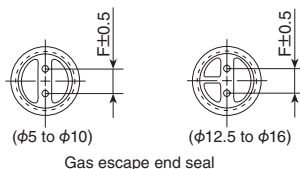
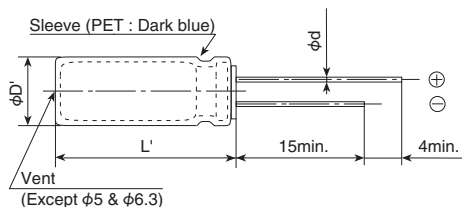

φD	5	6.3	8	10	12.5	16
φd	0.5	0.5	0.6	0.6	0.6	0.8
F	2.0	2.5	3.5	5.0	5.0	7.5
φD'	φD+0.5max.					
L'	L+1.5max.					

PART NUMBERING SYSTEM

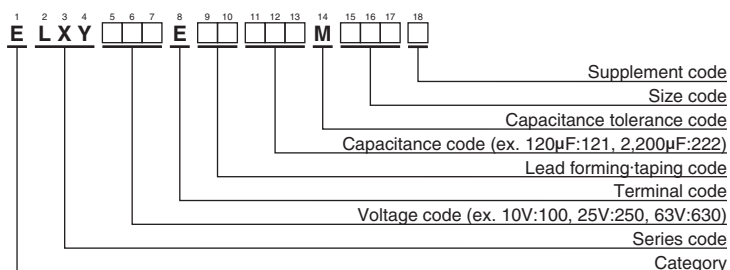

Please refer to "Product code guide (radial lead type)"

RATED RIPPLE CURRENT MULTIPLIERS

- Frequency Multipliers

Capacitance(μF)	Frequency(Hz)			
	120	1k	10k	100k
10 to 180	0.40	0.75	0.90	1.00
220 to 560	0.50	0.85	0.94	1.00
680 to 1,800	0.60	0.87	0.95	1.00
2,200 to 3,900	0.75	0.90	0.95	1.00
4,700 to 8,200	0.85	0.95	0.98	1.00

The endurance of capacitors is reduced with internal heating produced by ripple current at the rate of halving the lifetime with every 5°C rise. When long life performance is required in actual use, the rms ripple current has to be reduced.

Return Group Chart



MINIATURE ALUMINUM ELECTROLYTIC CAPACITORS

Low impedance, 105°C

LXV Series

- Low impedance
- Endurance with ripple current : 2,000 to 5,000 hours at 105°C
- Solvent resistant type (see PRECAUTIONS AND GUIDELINES)
- RoHS Compliant
- AEC-Q200 compliant : Please contact Chemi-Con for more details, test data, information.

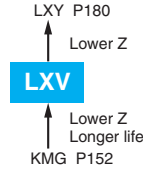

◆ SPECIFICATIONS

Items	Characteristics	
Category	-55 to +105°C	
Temperature Range	-55 to +105°C	
Rated Voltage Range	6.3 to 100V _{ac}	
Capacitance Tolerance	±20% (M) (at 20°C, 120Hz)	
Leakage Current	I=0.01CV or 3μA, whichever is greater. Where, I : Max. leakage current (μA), C : Nominal capacitance (μF), V : Rated voltage (V) (at 20°C after 2 minutes)	
Dissipation Factor (tan δ)	Rated voltage (V _{ac})	6.3V 10V 16V 25V 35V 50V 63V 80V 100V
	tan δ (Max.)	0.22 0.19 0.16 0.14 0.12 0.10 0.10 0.09 0.08
	When nominal capacitance exceeds 1,000μF, add 0.02 to the value above for each 1,000μF increase. (at 20°C, 120Hz)	
Low Temperature Characteristics	Capacitance change ΔC (-55°C /+20°C)	0.7min.
	Max. impedance ratio (-55°C /+20°C)	3max.(6.3V _{ac} : 4max.) (at 120Hz)
Endurance	The following specifications shall be satisfied when the capacitors are restored to 20°C after subjected to DC voltage with the rated ripple current is applied (the peak voltage shall not exceed the rated voltage) for the specified period of time at 105°C.	
	Time	φ 5 to 6.3 : 2,000hours φ 8 & 10: 3,000hours φ 12.5 to φ 18: 5,000hours
	Capacitance change	≤ ±20% of the initial value
	D.F. (tan δ)	≤ 200% of the initial specified value
	Leakage current	≤ The initial specified value
Shelf Life	The following specifications shall be satisfied when the capacitors are restored to 20°C after exposing them for 1,000 hours at 105°C without voltage applied. Before the measurement, the capacitor shall be preconditioned by applying voltage according to Item 4.1 of JIS C 5101-4.	
	Capacitance change	≤ ±20% of the initial value
	D.F. (tan δ)	≤ 200% of the initial specified value
	Leakage current	≤ The initial specified value

◆ DIMENSIONS [mm]

- Terminal Code : E

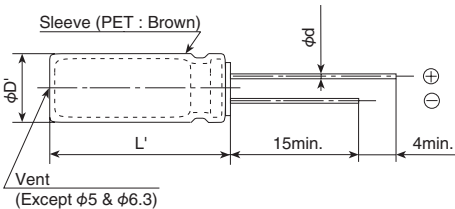

φD	5	6.3	8	10	12.5	16	18
φd	0.5	0.5	0.6	0.6	0.6	0.8	0.8
F	2.0	2.5	3.5	5.0	5.0	7.5	7.5
φD'	φD+0.5max.						
L'	L+1.5max.						

◆ PART NUMBERING SYSTEM

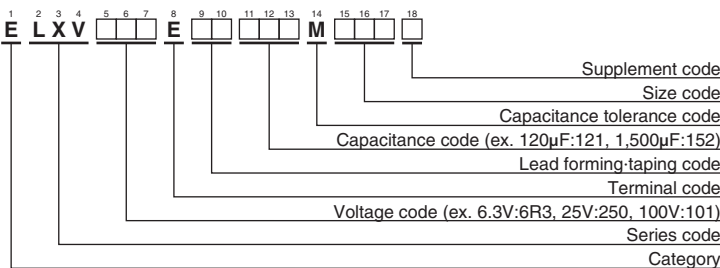

Please refer to "Product code guide (radial lead type)"

Return Group Chart



MINIATURE ALUMINUM ELECTROLYTIC CAPACITORS

160 to 500V_{dc}, long life, 105°C

KXJ Series

- Downsized and Longer life from current KXG series
- Endurance with ripple current : 8,000 to 12,000 hours at 105°C
- Rated voltage range : 160 to 500V, Capacitance range : 6.8 to 680μF
- For electronic ballast circuits and other long life applications
- Non solvent resistant type
- RoHS Compliant
- AEC-Q200 compliant : Please contact Chemi-Con for more details, test data, information.

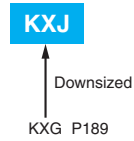

500V Lineup!

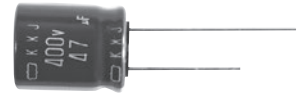

◆ SPECIFICATIONS

Items	Characteristics			
Category	-40 to +105°C (160 to 450V _{dc}) -25 to +105°C (500V _{dc})			
Temperature Range				
Rated Voltage Range	160 to 500V _{dc}			
Capacitance Tolerance	±20% (M) (at 20°C, 120Hz)			
Leakage Current		After 1 minute	After 5 minutes	
	CV ≤ 1000	I=0.1CV+40	I=0.03CV+15	
	CV > 1000	I=0.04CV+100	I=0.02CV+25	
	Where, I : Max. leakage current (μA), C : Nominal capacitance (μF), V : Rated voltage (V) (at 20°C)			
Dissipation Factor (tan δ)	Rated voltage (V _{dc})	160 to 250V	350 to 500V	
	tan δ (Max.)	0.20	0.24 (at 20°C, 120Hz)	
Low Temperature Characteristics (Max. Impedance Ratio)	Rated voltage (V _{dc})	160 to 250V	350, 400V	420 to 500V
	Z(-25°C)/Z(+20°C)	3	5	6 (at 120Hz)
	Z(-40°C)/Z(+20°C)	6	6	—
Endurance	The following specifications shall be satisfied when the capacitors are restored to 20°C after subjected to DC voltage with the rated ripple current is applied (the peak voltage shall not exceed the rated voltage) for the specified time at 105°C.			
	Rated voltage (V _{dc})	160 to 450V		500V
	Time	16L to 20L : 10,000hours, 25L to 50L : 12,000hours		φ10 : 8,000hours, φ12.5 to φ18 : 10,000hours
	Capacitance change	≤ ±20% of the initial value		
	D.F. (tan δ)	≤ 200% of the initial specified value		
	Leakage current	≤ The initial specified value		
Shelf Life	The following specifications shall be satisfied when the capacitors are restored to 20°C after exposing them for 1,000 hours at 105°C without voltage applied. Before the measurement, the capacitor shall be preconditioned by applying voltage according to Item 4.1 of JIS C 5101-4.			
	Capacitance change	≤ ±20% of the initial value		
	D.F. (tan δ)	≤ 200% of the initial specified value		
	Leakage current	≤ 500% of the initial specified value		

◆ DIMENSIONS [mm]

- Terminal Code : E

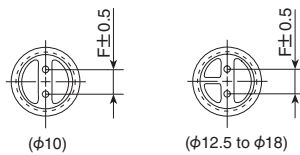
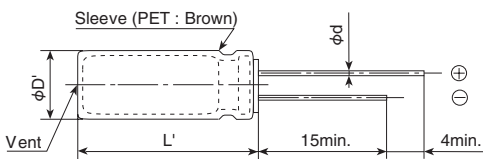

Gas escaped end seal

φD	10	12.5	14.5	16	18
φd	0.6	0.6	0.8	0.8	0.8
F	5.0	5.0	7.5	7.5	7.5
φD'	φD+0.5max.				
L'	L+1.5max.				

◆ PART NUMBERING SYSTEM

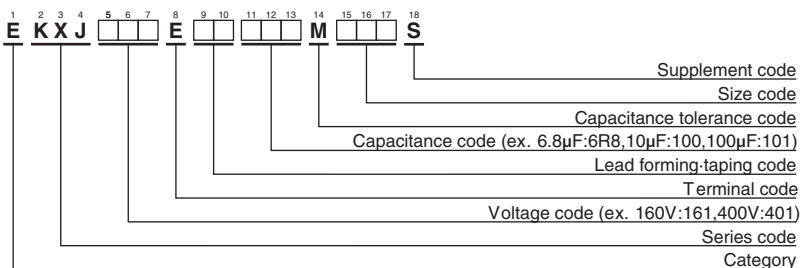

Please refer to "Product code guide (radial lead type)"

Return Group Chart



MINIATURE ALUMINUM ELECTROLYTIC CAPACITORS

160 to 500V_{dc}, long life, 105°C

KXJ Series

STANDARD RATINGS

WV (V _{dc})	Cap (μF)	Case size φD×L(mm)	tan δ	Rated ripple current (mA _{rms} /105°C, 120Hz)	Part No.	WV (V _{dc})	Cap (μF)	Case size φD×L(mm)	tan δ	Rated ripple current (mA _{rms} /105°C, 120Hz)	Part No.
350	12	10×16	0.24	135	EKXJ351E□□120MJ16S	420	6.8	10×16	0.24	105	EKXJ421E□□6R8MJ16S
	22	10×20	0.24	200	EKXJ351E□□220MJ20S		12	10×20	0.24	150	EKXJ421E□□120MJ20S
	27	10×25	0.24	240	EKXJ351E□□270MJ25S		15	10×25	0.24	185	EKXJ421E□□150MJ25S
	27	10×30	0.24	255	EKXJ351E□□270MJ30S		18	10×30	0.24	215	EKXJ421E□□180MJ30S
	33	12.5×20	0.24	330	EKXJ351E□□330MK20S		22	12.5×20	0.24	285	EKXJ421E□□220MK20S
	39	10×35	0.24	325	EKXJ351E□□390MJ35S		27	10×35	0.24	275	EKXJ421E□□270MJ35S
	47	10×40	0.24	375	EKXJ351E□□470MJ40S		27	10×40	0.24	290	EKXJ421E□□270MJ40S
	47	12.5×25	0.24	425	EKXJ351E□□470MK25S		27	12.5×25	0.24	340	EKXJ421E□□270MK25S
	47	14.5×20	0.24	420	EKXJ351E□□470MU20S		27	14.5×20	0.24	335	EKXJ421E□□270MU20S
	56	10×45	0.24	425	EKXJ351E□□560MJ45S		33	10×45	0.24	335	EKXJ421E□□330MJ45S
	56	12.5×30	0.24	495	EKXJ351E□□560MK30S		33	12.5×30	0.24	400	EKXJ421E□□330MK30S
	56	16×20	0.24	475	EKXJ351E□□560ML20S		33	16×20	0.24	385	EKXJ421E□□330ML20S
	68	10×50	0.24	485	EKXJ351E□□680MJ50S		39	10×50	0.24	375	EKXJ421E□□390MJ50S
	68	12.5×35	0.24	580	EKXJ351E□□680MK35S		39	14.5×25	0.24	435	EKXJ421E□□390MU25S
	68	14.5×25	0.24	545	EKXJ351E□□680MU25S		47	12.5×35	0.24	505	EKXJ421E□□470MK35S
	68	18×20	0.24	550	EKXJ351E□□680MM20S		47	16×25	0.24	500	EKXJ421E□□470ML25S
	82	12.5×40	0.24	655	EKXJ351E□□820MK40S		47	18×20	0.24	480	EKXJ421E□□470MM20S
	82	14.5×31.5	0.24	645	EKXJ351E□□820MUN3S		56	12.5×40	0.24	570	EKXJ421E□□560MK40S
	82	16×25	0.24	625	EKXJ351E□□820ML25S		56	12.5×45	0.24	590	EKXJ421E□□560MK45S
	100	12.5×45	0.24	750	EKXJ351E□□101MK45S		56	14.5×31.5	0.24	560	EKXJ421E□□560MUN3S
	100	12.5×50	0.24	770	EKXJ351E□□101MK50S		68	12.5×50	0.24	670	EKXJ421E□□680MK50S
	100	14.5×35.5	0.24	740	EKXJ351E□□101MUP1S		68	14.5×35.5	0.24	640	EKXJ421E□□680MUP1S
	100	16×31.5	0.24	740	EKXJ351E□□101MLN3S		68	14.5×40	0.24	660	EKXJ421E□□680MU40S
	100	18×25	0.24	710	EKXJ351E□□101MM25S		68	16×31.5	0.24	645	EKXJ421E□□680MLN3S
	120	14.5×40	0.24	835	EKXJ351E□□121MU40S		68	18×25	0.24	615	EKXJ421E□□680MM25S
	120	14.5×45	0.24	860	EKXJ351E□□121MU45S		82	14.5×45	0.24	750	EKXJ421E□□820MU45S
120	16×35.5	0.24	830	EKXJ351E□□121MLP1S	82	16×35.5	0.24	725	EKXJ421E□□820MLP1S		
150	14.5×50	0.24	980	EKXJ351E□□151MU50S	82	18×31.5	0.24	730	EKXJ421E□□820MMN3S		
150	16×40	0.24	960	EKXJ351E□□151ML40S	100	14.5×50	0.24	845	EKXJ421E□□101MU50S		
150	16×45	0.24	975	EKXJ351E□□151ML45S	100	16×40	0.24	825	EKXJ421E□□101ML40S		
150	18×31.5	0.24	940	EKXJ351E□□151MMN3S	100	16×45	0.24	840	EKXJ421E□□101ML45S		
180	16×50	0.24	1,090	EKXJ351E□□181ML50S	100	18×35.5	0.24	835	EKXJ421E□□101MMP1S		
180	18×35.5	0.24	1,065	EKXJ351E□□181MMP1S	120	16×50	0.24	935	EKXJ421E□□121ML50S		
180	18×40	0.24	1,080	EKXJ351E□□181MM40S	120	18×40	0.24	930	EKXJ421E□□121MM40S		
220	18×45	0.24	1,210	EKXJ351E□□221MM45S	120	18×45	0.24	945	EKXJ421E□□121MM45S		
220	18×50	0.24	1,220	EKXJ351E□□221MM50S	150	18×50	0.24	1,060	EKXJ421E□□151MM50S		
400	10	10×16	0.24	125	EKXJ401E□□100MJ16S	450	6.8	10×16	0.24	105	EKXJ451E□□6R8MJ16S
	18	10×20	0.24	180	EKXJ401E□□180MJ20S		12	10×20	0.24	150	EKXJ451E□□120MJ20S
	22	10×25	0.24	215	EKXJ401E□□220MJ25S		15	10×25	0.24	185	EKXJ451E□□150MJ25S
	27	10×30	0.24	255	EKXJ401E□□270MJ30S		18	10×30	0.24	215	EKXJ451E□□180MJ30S
	27	12.5×20	0.24	300	EKXJ401E□□270MK20S		18	12.5×20	0.24	255	EKXJ451E□□180MK20S
	33	10×35	0.24	300	EKXJ401E□□330MJ35S		22	10×35	0.24	250	EKXJ451E□□220MJ35S
	39	10×40	0.24	340	EKXJ401E□□390MJ40S		27	10×40	0.24	290	EKXJ451E□□270MJ40S
	39	10×45	0.24	355	EKXJ401E□□390MJ45S		27	10×45	0.24	305	EKXJ451E□□270MJ45S
	39	12.5×25	0.24	390	EKXJ401E□□390MK25S		27	12.5×25	0.24	340	EKXJ451E□□270MK25S
	39	14.5×20	0.24	385	EKXJ401E□□390MU20S		27	14.5×20	0.24	335	EKXJ451E□□270MU20S
	47	12.5×30	0.24	455	EKXJ401E□□470MK30S		33	12.5×30	0.24	400	EKXJ451E□□330MK30S
	47	16×20	0.24	435	EKXJ401E□□470ML20S		33	14.5×25	0.24	400	EKXJ451E□□330MU25S
	56	10×50	0.24	440	EKXJ401E□□560MJ50S		33	16×20	0.24	385	EKXJ451E□□330ML20S
	56	12.5×35	0.24	525	EKXJ401E□□560MK35S		39	10×50	0.24	375	EKXJ451E□□390MJ50S
	56	14.5×25	0.24	495	EKXJ401E□□560MU25S		39	12.5×35	0.24	460	EKXJ451E□□390MK35S
	56	18×20	0.24	500	EKXJ401E□□560MM20S		39	18×20	0.24	440	EKXJ451E□□390MM20S
	68	12.5×40	0.24	600	EKXJ401E□□680MK40S		47	12.5×40	0.24	525	EKXJ451E□□470MK40S
	68	14.5×31.5	0.24	585	EKXJ401E□□680MUN3S		47	14.5×31.5	0.24	515	EKXJ451E□□470MUN3S
	68	16×25	0.24	570	EKXJ401E□□680ML25S		47	16×25	0.24	500	EKXJ451E□□470ML25S
	82	12.5×45	0.24	680	EKXJ401E□□820MK45S		56	12.5×45	0.24	590	EKXJ451E□□560MK45S
	82	12.5×50	0.24	700	EKXJ401E□□820MK50S		56	14.5×35.5	0.24	580	EKXJ451E□□560MUP1S
	82	14.5×35.5	0.24	670	EKXJ401E□□820MUP1S		56	16×31.5	0.24	585	EKXJ451E□□560MLN3S
	82	16×31.5	0.24	670	EKXJ401E□□820MLN3S		56	18×25	0.24	560	EKXJ451E□□560MM25S
	82	18×25	0.24	640	EKXJ401E□□820MM25S		68	12.5×50	0.24	670	EKXJ451E□□680MK50S
	100	14.5×40	0.24	760	EKXJ401E□□101MU40S		68	14.5×40	0.24	660	EKXJ451E□□680MU40S
	100	14.5×45	0.24	785	EKXJ401E□□101MU45S		68	14.5×45	0.24	680	EKXJ451E□□680MU45S
100	16×35.5	0.24	760	EKXJ401E□□101MLP1S	68	16×35.5	0.24	660	EKXJ451E□□680MLP1S		
120	14.5×50	0.24	875	EKXJ401E□□121MU50S	82	14.5×50	0.24	765	EKXJ451E□□820MU50S		
120	16×40	0.24	860	EKXJ401E□□121ML40S	82	16×40	0.24	750	EKXJ451E□□820ML40S		
120	16×45	0.24	875	EKXJ401E□□121ML45S	82	16×45	0.24	760	EKXJ451E□□820ML45S		
120	18×31.5	0.24	840	EKXJ401E□□121MMN3S	82	18×31.5	0.24	730	EKXJ451E□□820MMN3S		
120	18×35.5	0.24	870	EKXJ401E□□121MMP1S	100	16×50	0.24	855	EKXJ451E□□101ML50S		
150	16×50	0.24	995	EKXJ401E□□151ML50S	100	18×35.5	0.24	835	EKXJ451E□□101MMP1S		
150	18×40	0.24	985	EKXJ401E□□151MM40S	120	18×40	0.24	930	EKXJ451E□□121MM40S		
180	18×45	0.24	1,095	EKXJ401E□□181MM45S	120	18×45	0.24	945	EKXJ451E□□121MM45S		
220	18×50	0.24	1,220	EKXJ401E□□221MM50S	150	18×50	0.24	1,060	EKXJ451E□□151MM50S		

□ □ : Enter the appropriate lead forming or taping code.



◆STANDARD RATINGS

WV (V _{dc})	Cap (μF)	Case size φD×L(mm)	tan δ	Rated ripple current (mA _{rms} /105°C, 120Hz)	Part No.
500	6.8	10 × 20	0.24	90	EKXJ501E□□6R8MJ20S
	8.2	10 × 25	0.24	110	EKXJ501E□□8R2MJ25S
	10	10 × 30	0.24	130	EKXJ501E□□100MJ30S
	12	12.5 × 20	0.24	135	EKXJ501E□□120MK20S
	15	10 × 35	0.24	170	EKXJ501E□□150MJ35S
	15	10 × 40	0.24	175	EKXJ501E□□150MJ40S
	15	12.5 × 25	0.24	165	EKXJ501E□□150MK25S
	18	10 × 45	0.24	190	EKXJ501E□□180MJ45S
	18	12.5 × 30	0.24	190	EKXJ501E□□180MK30S
	22	10 × 50	0.24	230	EKXJ501E□□220MJ50S
	22	12.5 × 35	0.24	220	EKXJ501E□□220MK35S
	27	12.5 × 40	0.24	260	EKXJ501E□□270MK40S
	33	12.5 × 45	0.24	285	EKXJ501E□□330MK45S
39	12.5 × 50	0.24	330	EKXJ501E□□390MK50S	

□□ : Enter the appropriate lead forming or taping code.

◆RATED RIPPLE CURRENT MULTIPLIERS

● Frequency Multipliers

(160 to 450V_{dc})

Capacitance(μF) \ Frequency(Hz)	120	1k	10k	100k
6.8 to 82	1.00	1.75	2.25	2.50
100 to 680	1.00	1.67	2.05	2.25

(500V_{dc})

Capacitance(μF) \ Frequency(Hz)	120	1k	10k	100k
6.8 to 22	1.00	1.78	2.30	2.59
27 to 39	1.00	1.75	2.25	2.50

The endurance of capacitors is reduced with internal heating produced by ripple current at the rate of halving the lifetime with every 5°C rise. When long life performance is required in actual use, the rms ripple current has to be reduced.

Return Group Chart



MINIATURE ALUMINUM ELECTROLYTIC CAPACITORS

160 to 450V_{dc} long life, 105°C

KXG Series

- For electronic ballast circuits and other long life applications
- Endurance with ripple current : 8,000 to 10,000 hours at 105°C
- Non solvent resistant type
- RoHS Compliant

KXJ P185
↓
Downsized
KXG



SPECIFICATIONS

Items	Characteristics			
Category	-40 to +105°C (160 to 400V _{dc}) -25 to +105°C (450V _{dc})			
Temperature Range				
Rated Voltage Range	160 to 450V _{dc}			
Capacitance Tolerance	±20% (M) (at 20°C, 120Hz)			
Leakage Current		After 1 minute	After 5 minutes	
	CV ≤ 1,000	I = 0.1CV + 40	I = 0.03CV + 15	
	CV > 1,000	I = 0.04CV + 100	I = 0.02CV + 25	
	Where, I : Max. leakage current (µA), C : Nominal capacitance (µF), V : Rated voltage (V) (at 20°C)			
Dissipation Factor (tan δ)	Rated voltage (V _{dc})	160 to 250V	350 to 450V	
	tan δ (Max.)	0.20	0.24	(at 20°C, 120Hz)
Low Temperature Characteristics (Max. Impedance Ratio)	Rated voltage (V _{dc})	160 to 250V	350 & 400V	450V
	Z(-25°C)/Z(+20°C)	3	5	6
	Z(-40°C)/Z(+20°C)	6	6	—
	(at 120Hz)			
Endurance	The following specifications shall be satisfied when the capacitors are restored to 20°C after subjected to DC voltage with the rated ripple current is applied (the peak voltage shall not exceed the rated voltage) for 10,000 hours (8,000 hours for φ10) at 105°C.			
	Capacitance change	≤ ±20% of the initial value		
	D.F. (tan δ)	≤ 200% of the initial specified value		
	Leakage current	≤ The initial specified value		
Shelf Life	The following specifications shall be satisfied when the capacitors are restored to 20°C after exposing them for 1,000 hours at 105°C without voltage applied. Before the measurement, the capacitor shall be preconditioned by applying voltage according to Item 4.1 of JIS C 5101-4.			
	Capacitance change	≤ ±20% of the initial value		
	D.F. (tan δ)	≤ 200% of the initial specified value		
	Leakage current	≤ 500% of the initial specified value		

DIMENSIONS [mm]

Terminal Code : E

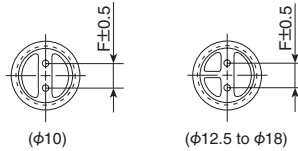
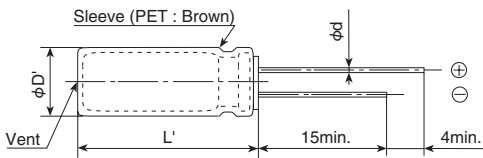

φD	10	12.5	16	18
φd	0.6	0.6	0.8	0.8
F	5.0	5.0	7.5	7.5
φD'	φD+0.5max.			
L'	L+1.5max.			

PART NUMBERING SYSTEM

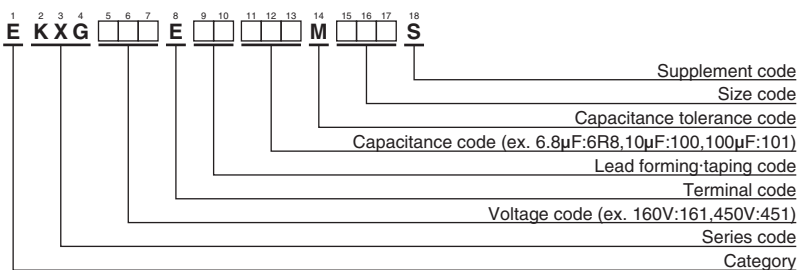

Please refer to "Product code guide (radial lead type)"

RATED RIPPLE CURRENT MULTIPLIERS

Frequency Multipliers

Capacitance(µF)	Frequency(Hz)			
	120	1k	10k	100k
6.8 to 82	1.00	1.75	2.25	2.50
100 to 330	1.00	1.67	2.05	2.25

The endurance of capacitors is reduced with internal heating produced by ripple current at the rate of halving the lifetime with every 5°C rise. When long life performance is required in actual use, the rms ripple current has to be reduced.

Return Group Chart



MINIATURE ALUMINUM ELECTROLYTIC CAPACITORS

160 to 450V_{dc} long life, 105°C

KXGSeries

◆STANDARD RATINGS

WV (V _{dc})	Cap (μF)	Case size φD×L(mm)	tan δ	Rated ripple current(mArms/105°C)		Part No.
				120Hz	100kHz	
160	10	10 × 16	0.20	125	315	EKXG161E□□100MJ16S
	22	10 × 20	0.20	200	500	EKXG161E□□220MJ20S
	33	10 × 20	0.20	250	625	EKXG161E□□330MJ20S
	47	10 × 20	0.20	300	750	EKXG161E□□470MJ20S
	68	12.5 × 20	0.20	470	1,175	EKXG161E□□680MK20S
	82	12.5 × 20	0.20	510	1,275	EKXG161E□□820MK20S
	100	12.5 × 25	0.20	620	1,395	EKXG161E□□101MK25S
	100	16 × 20	0.20	630	1,420	EKXG161E□□101ML20S
	150	16 × 20	0.20	770	1,735	EKXG161E□□151ML20S
200	10	10 × 16	0.20	125	315	EKXG201E□□100MJ16S
	22	10 × 20	0.20	200	500	EKXG201E□□220MJ20S
	33	10 × 20	0.20	260	650	EKXG201E□□330MJ20S
	47	12.5 × 20	0.20	390	975	EKXG201E□□470MK20S
	68	12.5 × 20	0.20	470	1,175	EKXG201E□□680MK20S
	82	16 × 20	0.20	550	1,375	EKXG201E□□820ML20S
	100	16 × 20	0.20	630	1,420	EKXG201E□□101ML20S
	150	16 × 25	0.20	840	1,890	EKXG201E□□151ML25S
	220	18 × 25	0.20	1,050	2,365	EKXG201E□□221MM25S
250	10	10 × 20	0.20	140	350	EKXG251E□□100MJ20S
	22	10 × 20	0.20	200	500	EKXG251E□□220MJ20S
	33	12.5 × 20	0.20	320	800	EKXG251E□□330MK20S
	47	12.5 × 20	0.20	390	975	EKXG251E□□470MK20S
	68	16 × 20	0.20	520	1,300	EKXG251E□□680ML20S
	82	16 × 20	0.20	550	1,375	EKXG251E□□820ML20S
	100	16 × 25	0.20	680	1,530	EKXG251E□□101ML25S
	150	18 × 25	0.20	860	1,935	EKXG251E□□151MM25S
	220	18 × 31.5	0.20	1,130	2,545	EKXG251E□□221MMN3S
350	6.8	10 × 16	0.24	110	275	EKXG351E□□6R8MJ16S
	10	10 × 20	0.24	140	350	EKXG351E□□100MJ20S
	22	12.5 × 20	0.24	260	650	EKXG351E□□220MK20S
	33	16 × 20	0.24	360	900	EKXG351E□□330ML20S
	47	16 × 20	0.24	430	1,075	EKXG351E□□470ML20S
	68	16 × 25	0.24	560	1,400	EKXG351E□□680ML25S
	68	18 × 20	0.24	550	1,375	EKXG351E□□680MM20S
	82	18 × 25	0.24	610	1,525	EKXG351E□□820MM25S
	100	18 × 25	0.24	700	1,575	EKXG351E□□101MM25S
400	120	18 × 31.5	0.24	830	1,865	EKXG351E□□121MMN3S
	150	18 × 35.5	0.24	960	2,160	EKXG351E□□151MMP1S
	6.8	10 × 16	0.24	110	275	EKXG401E□□6R8MJ16S
	10	10 × 20	0.24	140	350	EKXG401E□□100MJ20S
	15	12.5 × 20	0.24	220	550	EKXG401E□□150MK20S
	22	12.5 × 20	0.24	260	650	EKXG401E□□220MK20S
	33	16 × 20	0.24	360	900	EKXG401E□□330ML20S
	47	16 × 25	0.24	470	1,175	EKXG401E□□470ML25S
	47	18 × 20	0.24	450	1,125	EKXG401E□□470MM20S
450	68	18 × 25	0.24	585	1,465	EKXG401E□□680MM25S
	82	18 × 25	0.24	610	1,525	EKXG401E□□820MM25S
	100	18 × 31.5	0.24	765	1,720	EKXG401E□□101MMN3S
	120	18 × 35.5	0.24	865	1,945	EKXG401E□□121MMP1S
	150	18 × 40	0.24	985	2,215	EKXG401E□□151MM40S
	6.8	10 × 20	0.24	110	275	EKXG451E□□6R8MJ20S
	10	12.5 × 20	0.24	180	450	EKXG451E□□100MK20S
	15	12.5 × 25	0.24	240	600	EKXG451E□□150MK25S
	22	16 × 20	0.24	290	725	EKXG451E□□220ML20S
450	33	16 × 25	0.24	390	975	EKXG451E□□330ML25S
	33	18 × 20	0.24	380	950	EKXG451E□□330MM20S
	47	18 × 25	0.24	480	1,200	EKXG451E□□470MM25S
	68	18 × 31.5	0.24	630	1,575	EKXG451E□□680MMN3S
	82	18 × 35.5	0.24	715	1,785	EKXG451E□□820MMP1S
	100	18 × 40	0.24	800	1,800	EKXG451E□□101MM40S

□□ : Enter the appropriate lead forming or taping code.

Return Group Chart



MINIATURE ALUMINUM ELECTROLYTIC CAPACITORS

400 to 450V_{dc}, long life, 105°C

KWA Series

- Ideal for low profile power supply applications
- Longer life form KHE series
- Rated voltage range : 400 to 450V_{dc}, Capacitance range : 27 to 120μF
- Endurance with ripple current : 5,000 hours at 105°C
- Non solvent resistant type
- RoHS Compliant

KWA

Longer life
KHE P193

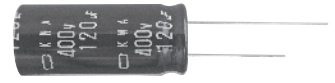

◆ SPECIFICATIONS

Items	Characteristics			
Category Temperature Range	-40 to +105°C			
Rated Voltage Range	400 to 450V _{dc}			
Capacitance Tolerance	±20% (M) (at 20°C, 120Hz)			
Leakage Current	I=0.04CV+100 (after 1 minute) I=0.02CV+25 (after 5 minutes) Where, I : Max. leakage current(μA), C : Nominal capacitance (μF), V : Rated voltage (V) (at 20°C)			
Dissipation Factor (tan δ)	Rated voltage (V _{dc})	400 to 450V		
	tan δ (Max.)	0.20 (at 20°C, 120Hz)		
Low Temperature Characteristics (Max. Impedance Ratio)	Rated voltage (V _{dc})	400V	420V	450V
	Z(-25°C)/Z(+20°C)	5	6	6
	Z(-40°C)/Z(+20°C)	6	—	—
Endurance	The following specifications shall be satisfied when the capacitors are restored to 20°C after subjected to DC voltage with the rated ripple current is applied (the peak voltage shall not exceed the rated voltage) for 5,000 hours at 105°C.			
	Capacitance change	≤ ±20% of the initial value		
	D.F. (tan δ)	≤200% of the initial specified value		
	Leakage current	≤The initial specified value		
Shelf Life	The following specifications shall be satisfied when the capacitors are restored to 20°C after exposing them for 1,000 hours at 105°C without voltage applied. Before the measurement, the capacitor shall be preconditioned by applying voltage according to Item 4.1 of JIS C 5101-4.			
	Capacitance change	≤ ±20% of the initial value		
	D.F. (tan δ)	≤200% of the initial specified value		
	Leakage current	≤500% of the initial specified value		

◆ DIMENSIONS [mm]

- Terminal Code : E

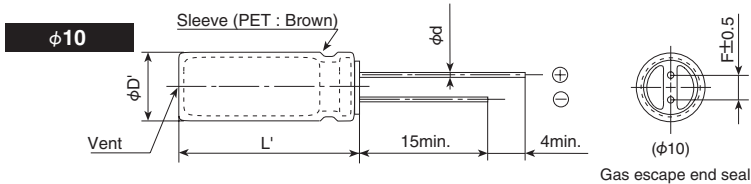

φD	10	12.5	14.5	16	18
φd	0.6	0.6	0.8	0.8	0.8
F	5.0	5.0	7.5	7.5	7.5
φD'	φD+0.5 max.				
L'	L+2.0 max.				

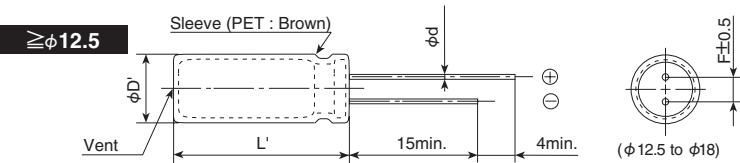

◆ PART NUMBERING SYSTEM

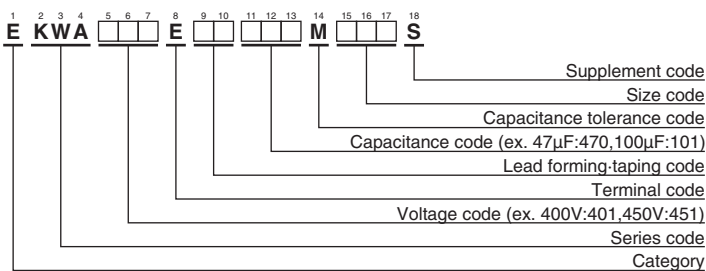

Please refer to "Product code guide (radial lead type)"

Return Group Chart



MINIATURE ALUMINUM ELECTROLYTIC CAPACITORS

400 to 450V_{dc}, long life, 105°C

KWASeries

◆STANDARD RATINGS

WV (V _{dc})	Cap (μF)	Case size φD×L(mm)	tan δ	Rated ripple current (mA _{rms} /105°C, 120Hz)	Part No.	WV (V _{dc})	Cap (μF)	Case size φD×L(mm)	tan δ	Rated ripple current (mA _{rms} /105°C, 120Hz)	Part No.
400	33	10×30	0.20	320	EKWA401E□□330MJ30S	450	27	10×30	0.20	290	EKWA451E□□270MJ30S
	39	10×35	0.20	370	EKWA401E□□390MJ35S		33	10×35	0.20	340	EKWA451E□□330MJ35S
	47	10×40	0.20	420	EKWA401E□□470MJ40S		39	10×40	0.20	380	EKWA451E□□390MJ40S
	56	10×45	0.20	480	EKWA401E□□560MJ45S		47	10×45	0.20	440	EKWA451E□□470MJ45S
	56	12.5×30	0.20	460	EKWA401E□□560MK30S		47	12.5×30	0.20	420	EKWA451E□□470MK30S
	68	12.5×35	0.20	530	EKWA401E□□680MK35S		56	12.5×35	0.20	480	EKWA451E□□560MK35S
	82	12.5×40	0.20	610	EKWA401E□□820MK40S		68	12.5×40	0.20	550	EKWA451E□□680MK40S
	82	14.5×31.5	0.20	590	EKWA401E□□820MUN3S		68	14.5×31.5	0.20	530	EKWA451E□□680MUN3S
	100	12.5×45	0.20	690	EKWA401E□□101MK45S		82	12.5×45	0.20	630	EKWA451E□□820MK45S
	100	14.5×40	0.20	700	EKWA401E□□101MU40S		82	14.5×35	0.20	620	EKWA451E□□820MU35S
	100	16×31.5	0.20	710	EKWA401E□□101MLN3S		82	16×31.5	0.20	640	EKWA451E□□820MLN3S
	120	14.5×45	0.20	790	EKWA401E□□121MU45S		100	14.5×45	0.20	720	EKWA451E□□101MU45S
120	16×35	0.20	800	EKWA401E□□121ML35S	100	16×35	0.20	730	EKWA451E□□101ML35S		
120	18×31.5	0.20	800	EKWA401E□□121MMN3S	120	18×31.5	0.20	800	EKWA451E□□121MMN3S		
420	33	10×30	0.20	320	EKWA421E□□330MJ30S						
	39	10×35	0.20	370	EKWA421E□□390MJ35S						
	47	10×40	0.20	420	EKWA421E□□470MJ40S						
	56	10×50	0.20	500	EKWA421E□□560MJ50S						
	56	12.5×30	0.20	460	EKWA421E□□560MK30S						
	68	12.5×35	0.20	530	EKWA421E□□680MK35S						
	68	14.5×31.5	0.20	530	EKWA421E□□680MUN3S						
	82	12.5×40	0.20	610	EKWA421E□□820MK40S						
	82	14.5×35	0.20	620	EKWA421E□□820MU35S						
	100	12.5×50	0.20	680	EKWA421E□□101MK50S						
	100	14.5×40	0.20	700	EKWA421E□□101MU40S						
	100	16×31.5	0.20	710	EKWA421E□□101MLN3S						
120	14.5×45	0.20	790	EKWA421E□□121MU45S							
120	16×35	0.20	800	EKWA421E□□121ML35S							
120	18×31.5	0.20	800	EKWA421E□□121MMN3S							

□□ : Enter the appropriate lead forming or taping code.

◆RATED RIPPLE CURRENT MULTIPLIERS

● Frequency Multipliers

Capacitance(μF)	Frequency(Hz)			
	120	1k	10k	100k
27 to 82	1.00	1.50	1.75	1.80
100 to 120	1.00	1.30	1.40	1.50

The endurance of capacitors is reduced with internal heating produced by ripple current at the rate of halving the lifetime with every 5°C rise. When long life performance is required in actual use, the rms ripple current has to be reduced.

Return Group Chart



MINIATURE ALUMINUM ELECTROLYTIC CAPACITORS

400 to 450V_{dc}, Downsized, 105°C

KHE Series

- Ideal for low profile power supply applications
- Downsize, high ripple design
- Rated voltage range : 400 to 450V_{dc}, Capacitance range : 27 to 120μF
- Endurance with ripple current : 2,000 hours at 105°C
- Non solvent resistant type
- RoHS Compliant

KHE
↓
Downsized
PAG P195



◆ SPECIFICATIONS

Items	Characteristics			
Category	-40 to +105°C			
Temperature Range	-40 to +105°C			
Rated Voltage Range	400 to 450V _{dc}			
Capacitance Tolerance	±20% (M) (at 20°C, 120Hz)			
Leakage Current		After 1 minute	After 5 minutes	
	CV ≤ 1,000	I = 0.1CV + 40	I = 0.03CV + 15	
	CV > 1,000	I = 0.04CV + 100	I = 0.02CV + 25	
	Where, I : Max. leakage current (μA), C : Nominal capacitance (μF), V : Rated voltage (V) (at 20°C)			
Dissipation Factor (tan δ)	Rated voltage (V _{dc})	400V	420V	450V
	tan δ (Max.)	0.15	0.20	0.20
	(at 20°C, 120Hz)			
Low Temperature Characteristics (Max. Impedance Ratio)	Rated voltage (V _{dc})	400V	420V	450V
	Z(-25°C)/Z(+20°C)	5	6	6
	Z(-40°C)/Z(+20°C)	6	—	—
	(at 120Hz)			
Endurance	The following specifications shall be satisfied when the capacitors are restored to 20°C after subjected to DC voltage with the rated ripple current is applied (the peak voltage shall not exceed the rated voltage) for 2,000 hours at 105°C.			
	Capacitance change	≤ ±20% of the initial value		
	D.F. (tan δ)	≤ 200% of the initial specified value		
	Leakage current	≤ The initial specified value		
Shelf Life	The following specifications shall be satisfied when the capacitors are restored to 20°C after exposing them for 1,000 hours at 105°C without voltage applied. Before the measurement, the capacitor shall be preconditioned by applying voltage according to Item 4.1 of JIS C 5101-4.			
	Capacitance change	≤ ±20% of the initial value		
	D.F. (tan δ)	≤ 200% of the initial specified value		
	Leakage current	≤ 500% of the initial specified value		

◆ DIMENSIONS [mm]

● Terminal Code : E

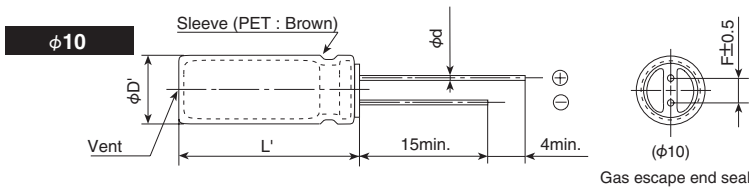

φD	10	12.5	14.5	16	18
φd	0.6	0.6	0.8	0.8	0.8
F	5.0	5.0	7.5	7.5	7.5
φD'	φD+0.5 max.				
L'	L+2.0 max.				

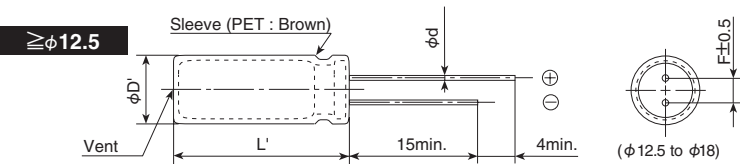

◆ PART NUMBERING SYSTEM

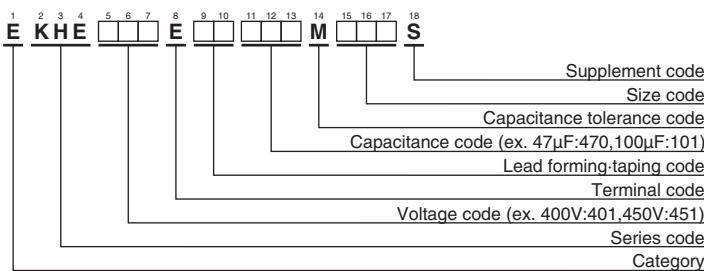

Please refer to "Product code guide (radial lead type)"

Return Group Chart



MINIATURE ALUMINUM ELECTROLYTIC CAPACITORS

400 to 450V_{dc}, Downsized, 105°C

KHESeries

◆STANDARD RATINGS

WV (V _{dc})	Cap (μF)	Case size φD×L(mm)	tan δ	Rated ripple current (mA _{rms} /105°C, 120Hz)	Part No.	WV (V _{dc})	Cap (μF)	Case size φD×L(mm)	tan δ	Rated ripple current (mA _{rms} /105°C, 120Hz)	Part No.
400	33	10×30	0.15	335	EKHE401E□□330MJ30S	450	27	10×30	0.20	305	EKHE451E□□270MJ30S
	39	10×35	0.15	385	EKHE401E□□390MJ35S		33	10×35	0.20	355	EKHE451E□□330MJ35S
	47	10×40	0.15	445	EKHE401E□□470MJ40S		39	10×40	0.20	405	EKHE451E□□390MJ40S
	56	10×45	0.15	505	EKHE401E□□560MJ45S		47	10×45	0.20	460	EKHE451E□□470MJ45S
	56	12.5×30	0.15	480	EKHE401E□□560MK30S		47	12.5×30	0.20	440	EKHE451E□□470MK30S
	68	12.5×35	0.15	560	EKHE401E□□680MK35S		56	12.5×35	0.20	505	EKHE451E□□560MK35S
	82	12.5×40	0.15	640	EKHE401E□□820MK40S		68	12.5×40	0.20	580	EKHE451E□□680MK40S
	82	14.5×31.5	0.15	625	EKHE401E□□820MUN3S		68	14.5×31.5	0.20	570	EKHE451E□□680MUN3S
	100	12.5×45	0.15	730	EKHE401E□□101MK45S		82	12.5×45	0.20	660	EKHE451E□□820MK45S
	100	14.5×35	0.15	715	EKHE401E□□101MU35S		82	14.5×35	0.20	650	EKHE451E□□820MU35S
	100	16×31.5	0.15	720	EKHE401E□□101MLN3S		82	16×31.5	0.20	655	EKHE451E□□820MLN3S
	120	14.5×40	0.15	810	EKHE401E□□121MU40S		100	14.5×40	0.20	740	EKHE451E□□101MU40S
120	16×35	0.15	810	EKHE401E□□121ML35S	100	16×35	0.20	740	EKHE451E□□101ML35S		
120	18×31.5	0.15	815	EKHE401E□□121MMN3S	120	18×31.5	0.20	815	EKHE451E□□121MMN3S		
420	33	10×30	0.20	335	EKHE421E□□330MJ30S						
	39	10×35	0.20	385	EKHE421E□□390MJ35S						
	47	10×40	0.20	445	EKHE421E□□470MJ40S						
	56	10×50	0.20	520	EKHE421E□□560MJ50S						
	56	12.5×30	0.20	480	EKHE421E□□560MK30S						
	68	12.5×35	0.20	560	EKHE421E□□680MK35S						
	82	12.5×40	0.20	640	EKHE421E□□820MK40S						
	82	14.5×31.5	0.20	625	EKHE421E□□820MUN3S						
	100	12.5×50	0.20	750	EKHE421E□□101MK50S						
	100	14.5×40	0.20	740	EKHE421E□□101MU40S						
	100	16×31.5	0.20	720	EKHE421E□□101MLN3S						
	120	14.5×45	0.20	835	EKHE421E□□121MU45S						
120	16×35	0.20	810	EKHE421E□□121ML35S							
120	18×31.5	0.20	815	EKHE421E□□121MMN3S							

□□ : Enter the appropriate lead forming or taping code.

◆RATED RIPPLE CURRENT MULTIPLIERS

● Frequency Multipliers

Capacitance(μF)	Frequency(Hz)	120	1k	10k	100k
27 to 82	120	1.00	1.50	1.75	1.80
	1000	1.00	1.30	1.40	1.50

The endurance of capacitors is reduced with internal heating produced by ripple current at the rate of halving the lifetime with every 5°C rise. When long life performance is required in actual use, the rms ripple current has to be reduced.

Return Group Chart



MINIATURE ALUMINUM ELECTROLYTIC CAPACITORS

200 to 450V_{dc}, Downsized, 105°C

PAG Series

- Downsize, high ripple design (φ 10 to 18)
- Rated voltage range : 200 to 450V_{dc}, Capacitance range : 18 to 560μF
- Endurance with ripple current : 2,000 hours at 105°C
- Ideal for low profile power supply applications
- Non solvent resistant type
- RoHS Compliant

PAG

↓
Downsized
Higher ripple

KMG P152



◆ SPECIFICATIONS

Items	Characteristics				
Category	-40 to +105°C (200, 400V _{dc}) -25 to +105°C (420, 450V _{dc})				
Temperature Range					
Rated Voltage Range	200 to 450V _{dc}				
Capacitance Tolerance	±20% (M) (at 20°C, 120Hz)°C				
Leakage Current		After 1 minute		After 5 minutes	
	CV ≤ 1,000	I=0.1CV+40		I=0.03CV+15	
	CV > 1,000	I=0.04CV+100		I=0.02CV+25	
	Where, I : Max. leakage current(μA), C : Nominal capacitance (μF), V : Rated voltage (V) (at 20°C)°C				
Dissipation Factor (tan δ)	Rated voltage (V _{dc})	200V	400V	420V	450V
	tan δ (Max.)	0.12	0.15	0.20	0.20
(at 20°C, 120Hz)°C					
Low Temperature Characteristics (Max. Impedance Ratio)	Rated voltage (V _{dc})	200V	400V	420V	450V
	Z(-25°C)/Z(+20°C)	3	5	6	6
	Z(-40°C)/Z(+20°C)	6	6	—	—
(at 120Hz)					
Endurance	The following specifications shall be satisfied when the capacitors are restored to 20°C after subjected to DC voltage with the rated ripple current is applied (the peak voltage shall not exceed the rated voltage) for 2,000 hours at 105°C.				
	Capacitance change	≤ ±20% of the initial value			
	D.F. (tan δ)	≤ 200% of the initial specified value			
	Leakage current	≤ The initial specified value			
Shelf Life	The following specifications shall be satisfied when the capacitors are restored to 20°C after exposing them for 1,000 hours at 105°C without voltage applied. Before the measurement, the capacitor shall be preconditioned by applying voltage according to Item 4.1 of JIS C 5101-4.				
	Capacitance change	≤ ±20% of the initial value			
	D.F. (tan δ)	≤ 200% of the initial specified value			
	Leakage current	≤ 500% of the initial specified value			

◆ DIMENSIONS [mm]

● Terminal Code : E

φ10 & φ12.5

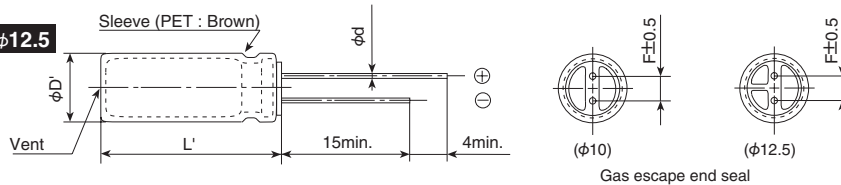

φD	10	12.5	14.5	16	18
φd	0.6	0.6	0.8	0.8	0.8
F	5.0	5.0	7.5	7.5	7.5
φD'	φD+0.5 max.				
L'	L+2.0 max.				

≥ φ14.5

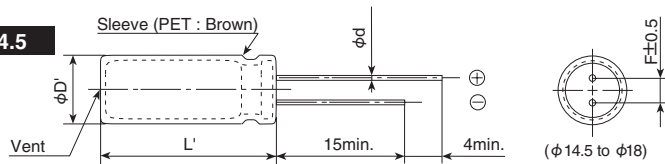

◆ PART NUMBERING SYSTEM

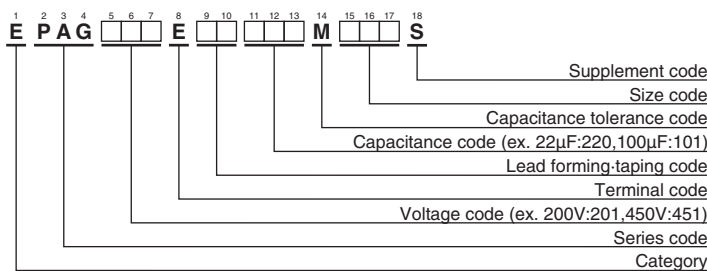

Please refer to "Product code guide (radial lead type)"

Return Group Chart



MINIATURE ALUMINUM ELECTROLYTIC CAPACITORS

200 to 450V_{dc}, Downsized, 105°C

PAGSeries

◆STANDARD RATINGS

WV (V _{dc})	Cap (μF)	Case size φD×L(mm)	tan δ	Rated ripple current (mA _{rms} /105°C, 120Hz)	Part No.	WV (V _{dc})	Cap (μF)	Case size φD×L(mm)	tan δ	Rated ripple current (mA _{rms} /105°C, 120Hz)	Part No.
200	82	10×30	0.12	440	EPAG201E□□820MJ30S	420	22	10×30	0.20	230	EPAG421E□□220MJ30S
	100	10×35	0.12	510	EPAG201E□□101MJ35S		27	10×35	0.20	270	EPAG421E□□270MJ35S
	120	10×40	0.12	590	EPAG201E□□121MJ40S		33	10×40	0.20	310	EPAG421E□□330MJ40S
	150	12.5×30	0.12	650	EPAG201E□□151MK30S		39	12.5×30	0.20	330	EPAG421E□□390MK30S
	180	12.5×35	0.12	750	EPAG201E□□181MK35S		47	12.5×35	0.20	390	EPAG421E□□470MK35S
	220	12.5×40	0.12	830	EPAG201E□□221MK40S		56	12.5×40	0.20	430	EPAG421E□□560MK40S
	220	14.5×30	0.12	830	EPAG201E□□221MU30S		56	14.5×30	0.20	430	EPAG421E□□560MU30S
	270	14.5×35	0.12	960	EPAG201E□□271MU35S		68	14.5×35	0.20	510	EPAG421E□□680MU35S
	270	16×30	0.12	960	EPAG201E□□271ML30S		68	16×30	0.20	510	EPAG421E□□680ML30S
	330	16×35	0.12	1,100	EPAG201E□□331ML35S		82	14.5×40	0.20	570	EPAG421E□□820MK40S
	330	18×30	0.12	1,100	EPAG201E□□331MM30S		82	16×35	0.20	570	EPAG421E□□820ML35S
	390	16×40	0.12	1,240	EPAG201E□□391ML40S		100	16×40	0.20	610	EPAG421E□□101ML40S
	390	18×35	0.12	1,240	EPAG201E□□391MM35S		100	18×30	0.20	610	EPAG421E□□101MM30S
	470	18×40	0.12	1,390	EPAG201E□□471MM40S		120	18×35	0.20	690	EPAG421E□□121MM35S
560	18×45	0.12	1,560	EPAG201E□□561MM45S	150	18×40	0.20	790	EPAG421E□□151MM40S		
400	27	10×30	0.15	260	EPAG401E□□270MJ30S	450	18	10×30	0.20	210	EPAG451E□□180MJ30S
	33	10×35	0.15	300	EPAG401E□□330MJ35S		22	10×35	0.20	240	EPAG451E□□220MJ35S
	39	10×40	0.15	340	EPAG401E□□390MJ40S		27	10×40	0.20	280	EPAG451E□□270MJ40S
	47	12.5×30	0.15	370	EPAG401E□□470MK30S		33	12.5×30	0.20	310	EPAG451E□□330MK30S
	56	12.5×35	0.15	420	EPAG401E□□560MK35S		39	12.5×35	0.20	350	EPAG451E□□390MK35S
	68	12.5×40	0.15	480	EPAG401E□□680MK40S		47	12.5×40	0.20	390	EPAG451E□□470MK40S
	68	14.5×30	0.15	480	EPAG401E□□680MU30S		47	14.5×30	0.20	390	EPAG451E□□470MU30S
	82	14.5×35	0.15	530	EPAG401E□□820MU35S		56	14.5×35	0.20	440	EPAG451E□□560MU35S
	100	14.5×40	0.15	580	EPAG401E□□101MU40S		56	16×30	0.20	440	EPAG451E□□560ML30S
	100	16×30	0.15	580	EPAG401E□□101ML30S		68	14.5×40	0.20	500	EPAG451E□□680MU40S
	120	16×35	0.15	670	EPAG401E□□121ML35S		68	16×35	0.20	500	EPAG451E□□680ML35S
	120	18×30	0.15	670	EPAG401E□□121MM30S		82	16×40	0.20	550	EPAG451E□□820ML40S
	150	16×40	0.15	770	EPAG401E□□151ML40S		82	18×30	0.20	550	EPAG451E□□820MM30S
	150	18×35	0.15	770	EPAG401E□□151MM35S		100	18×35	0.20	650	EPAG451E□□101MM35S
180	18×40	0.15	880	EPAG401E□□181MM40S	120	18×40	0.20	740	EPAG451E□□121MM40S		
220	18×45	0.15	1,000	EPAG401E□□221MM45S	150	18×45	0.20	810	EPAG451E□□151MM45S		

□□ : Enter the appropriate lead forming or taping code.

◆RATED RIPPLE CURRENT MULTIPLIERS

● Frequency Multipliers

Capacitance(μF)	Frequency(Hz)	120	1k	10k	100k
18 to 82		1.00	1.50	1.75	1.80
100 to 560		1.00	1.30	1.40	1.50

The endurance of capacitors is reduced with internal heating produced by ripple current at the rate of halving the lifetime with every 5°C rise. When long life performance is required in actual use, the rms ripple current has to be reduced.

Return Group Chart



MINIATURE ALUMINUM ELECTROLYTIC CAPACITORS

Overvoltage resistant design, 105°C

KLJ Series

- Doesn't spark with DC over voltage
- Endurance with ripple current : 2,000 hours at 105°C
- Non solvent resistant type
- ESR value prescribed
- RoHS Compliant

Doesn't spark with DC over voltage!

KLJ

↓
Downsized
↑
KLG



SPECIFICATIONS

Items	Characteristics				
Category	-25 to +105°C				
Temperature Range	-25 to +105°C				
Rated Voltage Range	200 to 450V _{dc}				
Capacitance Tolerance	±20% (M) (at 20°C, 120Hz)				
Leakage Current	I=0.04CV+100 Where, I : Max. leakage current (μA), C : Nominal capacitance (μF), V : Rated voltage (V) (at 20°C after 1 minute)				
Dissipation Factor (tan δ)	Rated voltage (V _{dc})	200V	400V	450V	
	tan δ (Max.)	0.20	0.24	0.24	(at 20°C, 120Hz)
Low Temperature Characteristics (Max. Impedance Ratio)	Rated voltage (V _{dc})	200V	400V	450V	
	Z(-25°C)/Z(+20°C)	4	6	6	(at 120Hz)
Endurance	The following specifications shall be satisfied when the capacitors are restored to 20°C after subjected to DC voltage with the rated ripple current is applied (the peak voltage shall not exceed the rated voltage) for 2,000 hours at 105°C.				
	Capacitance change	≤ ±20% of the initial value			
	D.F. (tan δ)	≤200% of the initial specified value			
	Leakage current	≤The initial specified value			
Shelf Life	The following specifications shall be satisfied when the capacitors are restored to 20°C after exposing them for 1,000 hours at 105°C without voltage applied. Before the measurement, the capacitor shall be preconditioned by applying voltage according to Item 4.1 of JIS C 5101-4.				
	Capacitance change	≤ ±20% of the initial value			
	D.F. (tan δ)	≤200% of the initial specified value			
	Leakage current	≤500% of the initial specified value			

DIMENSIONS [mm]

Terminal Code : E

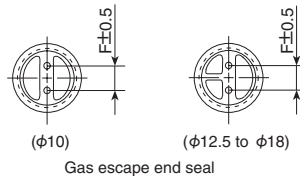
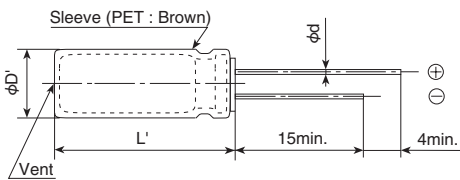

φD	10	12.5	16	18
φd	0.6	0.6	0.8	0.8
F	5.0	5.0	7.5	7.5
φD'	φD+0.5max.			
L'	L+1.5max.			

PART NUMBERING SYSTEM

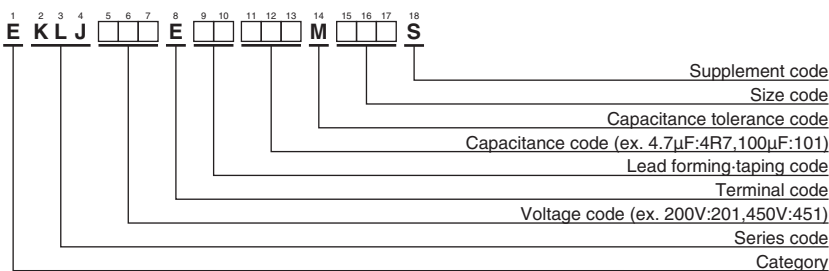

Please refer to "Product code guide (radial lead type)"

RATED RIPPLE CURRENT MULTIPLIERS

Frequency Multipliers

Capacitance(μF)	Frequency(Hz)					
	120	300	1k	10k	50k	100k
4.7 to 10μF	1.00	1.35	1.75	2.30	2.50	2.70
15 to 47μF	1.00	1.25	1.50	1.75	1.80	1.85
56 to 330μF	1.00	1.15	1.30	1.40	1.50	1.60

The endurance of capacitors is reduced with internal heating produced by ripple current at the rate of halving the lifetime with every 5°C rise. When long life performance is required in actual use, the rms ripple current has to be reduced.

Return Group Chart



MINIATURE ALUMINUM ELECTROLYTIC CAPACITORS

Overvoltage resistant design, 105°C

KLJ Series

◆STANDARD RATINGS

WV (V _{dc})	Cap (μF)	Case size φD×L(mm)	tan δ	ESR (Ω max/20°C, 100kHz)	Rated ripple current (mA rms/105°C, 120Hz)	Part No.
200	33	10×20	0.20	1.8	165	EKLJ201E□□330MJ20S
	39	10×25	0.20	1.4	200	EKLJ201E□□390MJ25S
	56	12.5×20	0.20	1.0	265	EKLJ201E□□560MK20S
	82	12.5×25	0.20	0.72	350	EKLJ201E□□820MK25S
	100	16×20	0.20	0.63	390	EKLJ201E□□101ML20S
	120	16×25	0.20	0.44	465	EKLJ201E□□121ML25S
	150	18×20	0.20	0.31	505	EKLJ201E□□151MM20S
	180	16×31.5	0.20	0.36	615	EKLJ201E□□181MLN3S
	180	18×25	0.20	0.30	585	EKLJ201E□□181MM25S
	220	16×35.5	0.20	0.30	695	EKLJ201E□□221MLP1S
	220	18×31.5	0.20	0.28	700	EKLJ201E□□221MMN3S
270	18×35.5	0.20	0.24	805	EKLJ201E□□271MMP1S	
330	18×40	0.20	0.21	900	EKLJ201E□□331MM40S	
400	4.7	10×12.5	0.24	8.4	36	EKLJ401E□□4R7MJC5S
	10	10×16	0.24	5.7	64	EKLJ401E□□100MJ16S
	15	10×20	0.24	4.0	105	EKLJ401E□□150MJ20S
	18	10×25	0.24	3.2	110	EKLJ401E□□180MJ25S
	22	12.5×20	0.24	2.7	165	EKLJ401E□□220MK20S
	27	12.5×25	0.24	1.9	200	EKLJ401E□□270MK25S
	33	16×20	0.24	1.5	225	EKLJ401E□□330ML20S
	39	18×20	0.24	1.2	255	EKLJ401E□□390MM20S
	39	18×25	0.24	0.72	270	EKLJ401E□□390MM25S
	47	16×25	0.24	1.1	290	EKLJ401E□□470ML25S
	47	18×20	0.24	1.2	280	EKLJ401E□□470MM20S
	56	16×31.5	0.24	0.84	340	EKLJ401E□□560MLN3S
	68	16×35.5	0.24	0.72	385	EKLJ401E□□680MLP1S
	68	18×25	0.24	0.88	360	EKLJ401E□□680MM25S
	82	16×40	0.24	0.65	435	EKLJ401E□□820ML40S
	82	18×31.5	0.24	0.64	425	EKLJ401E□□820MMN3S
100	18×35.5	0.24	0.54	490	EKLJ401E□□101MMP1S	
120	18×40	0.24	0.49	540	EKLJ401E□□121MM40S	
450	39	16×25	0.24	1.4	265	EKLJ451E□□390ML25S
	39	18×20	0.24	1.4	255	EKLJ451E□□390MM20S
	47	16×25	0.24	1.3	290	EKLJ451E□□470ML25S
	47	18×25	0.24	1.2	320	EKLJ451E□□470MM25S
	56	16×31.5	0.24	1.1	340	EKLJ451E□□560MLN3S
	68	16×35.5	0.24	0.86	420	EKLJ451E□□680MLP1S
	68	18×31.5	0.24	0.91	390	EKLJ451E□□680MMN3S
	82	16×40	0.24	0.79	435	EKLJ451E□□820ML40S
	82	18×31.5	0.24	0.78	425	EKLJ451E□□820MMN3S
	100	18×40	0.24	0.67	490	EKLJ451E□□101MM40S
	110	18×40	0.24	0.59	540	EKLJ451E□□111MM40S
120	18×45	0.24	0.58	570	EKLJ451E□□121MM45S	

□□ : Enter the appropriate lead forming or taping code.

◆DC OVERVOLTAGE TEST CONDITIONS

The vent will operate and the capacitor shall become an open circuit without burning materials when the following excess DC voltage is applied.

●Test DC voltage

Rated voltage	Nominal capacitance	Current limit	Test DC voltage
200V _{dc}	<330μF	4A	300/375V _{dc}
	330μF	5A	
400V _{dc}	<100μF	2A	500/600V _{dc}
	100μF ≤ C ≤ 120μF	4A	
450V _{dc}	<100μF	2A	550/675V _{dc}
	100μF ≤ C ≤ 120μF	4A	

●Test circuit

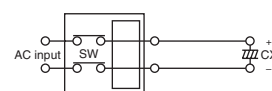

Constant DC voltage/current power supply

Return Group Chart



MINIATURE ALUMINUM ELECTROLYTIC CAPACITORS

160 to 450V_{dc} long life, 105°C

KXF Series New!

- For LED light circuits and other long life applications
- Rated voltage range : 160 to 450 V_{dc} , Capacitance range : 5.6 to 68μF
- Endurance with ripple current : 15,000 to 20,000 hours at 105°C
- Non solvent resistant type
- RoHS Compliant

KXF

↑ Longer life
KXE P201

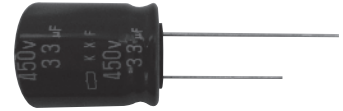

SPECIFICATIONS

Items	Characteristics		
Category	-40 to +105°C		
Temperature Range	-40 to +105°C		
Rated Voltage Range	160 to 450V _{dc}		
Capacitance Tolerance	±20% (M) (at 20°C, 120Hz)		
Leakage Current	After 1 minute	After 5 minutes	
	$I=0.04CV+100$	$I=0.02CV+25$	
	Where, I : Max. leakage current (μA), C : Nominal capacitance (μF), V : Rated voltage (V) (at 20°C)		
Dissipation Factor (tan δ)	Rated voltage (V _{dc})	160 to 450V	
	tan δ (Max.)	0.24	(at 20°C, 120Hz)
Low Temperature Characteristics (Max. Impedance Ratio)	Rated voltage (V _{dc})	160 to 250V	400, 450V
	Z(-25°C)/Z(+20°C)	3	6
	Z(-40°C)/Z(+20°C)	8	10
	(at 120Hz)		
Endurance	The following specifications shall be satisfied when the capacitors are restored to 20°C after subjected to DC voltage with the rated ripple current is applied (the peak voltage shall not exceed the rated voltage) for 20,000 hours (15,000 hours for φ10×12.5L) at 105°C.		
	Capacitance change	≤ ±30% of the initial value	
	D.F. (tan δ)	≤300% of the initial specified value	
	Leakage current	≤The initial specified value	
Shelf Life	The following specifications shall be satisfied when the capacitors are restored to 20°C after exposing them for 1,000 hours at 105°C without voltage applied. Before the measurement, the capacitor shall be preconditioned by applying voltage according to Item 4.1 of JIS C 5101-4.		
	Capacitance change	≤ ±30% of the initial value	
	D.F. (tan δ)	≤300% of the initial specified value	
	Leakage current	≤500% of the initial specified value	

DIMENSIONS [mm]

- Terminal Code : E

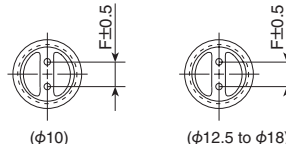
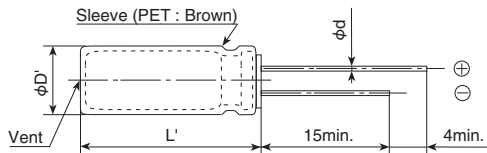

φD	10	12.5	16	18
φd	0.6	0.6	0.8	0.8
F	5.0	5.0	7.5	7.5
φD'	φD+0.5max.			
L'	L+1.5max.			

PART NUMBERING SYSTEM

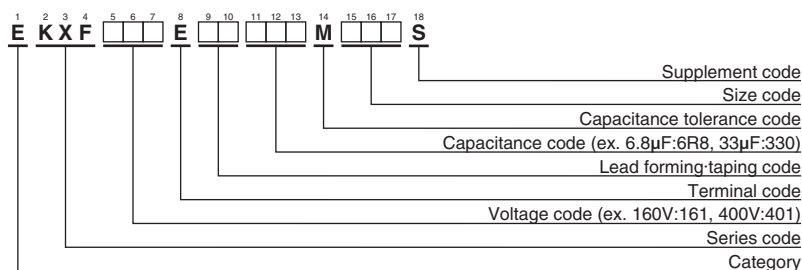

Please refer to "Product code guide (radial lead type)"

RATED RIPPLE CURRENT MULTIPLIERS

- Frequency Multipliers

Capacitance(μF)	Frequency(Hz)			
	120	1k	10k	100k
5.6 ~ 68	1.00	1.75	2.25	2.50

The endurance of capacitors is reduced with internal heating produced by ripple current at the rate of halving the lifetime with every 5°C rise. When long life performance is required in actual use, the rms ripple current has to be reduced.

Return Group Chart



MINIATURE ALUMINUM ELECTROLYTIC CAPACITORS

160 to 450Vdc long life, 105°C

KXF New!
Series

◆STANDARD RATINGS

WV (V _{dc})	Cap (μF)	Case size φD×L(mm)	tan δ	Rated ripple current (mA _{rms} /105°C, 120Hz)	Part No.
160	22	10×12.5	0.24	121	EKXF161E□□220MJC5S
	33	10×16	0.24	158	EKXF161E□□330MJ16S
200	18	10×12.5	0.24	113	EKXF201E□□180MJC5S
	27	10×16	0.24	149	EKXF201E□□270MJ16S
250	10	10×12.5	0.24	90	EKXF251E□□100MJC5S
	12	10×12.5	0.24	97	EKXF251E□□120MJC5S
	18	10×16	0.24	129	EKXF251E□□180MJ16S
400	5.6	10×12.5	0.24	64	EKXF401E□□5R6MJC5S
	8.2	10×16	0.24	88	EKXF401E□□8R2MJ16S
450	6.8	10×16	0.24	62	EKXF451E□□6R8MJ16S
	8.2	10×16	0.24	88	EKXF451E□□8R2MJ16S
	10	10×20	0.24	92	EKXF451E□□100MJ20S
	15	12.5×20	0.24	140	EKXF451E□□150MK20S
	22	12.5×25	0.24	240	EKXF451E□□220MK25S
	27	16×20	0.24	305	EKXF451E□□270ML20S
	33	16×25	0.24	392	EKXF451E□□330ML25S
	33	18×20	0.24	312	EKXF451E□□330MM20S
	47	18×25	0.24	480	EKXF451E□□470MM25S
	68	18×31.5	0.24	520	EKXF451E□□680MMN3S

□□ : Enter the appropriate lead forming or taping code.

Return Group Chart



MINIATURE ALUMINUM ELECTROLYTIC CAPACITORS

160 to 400V_{dc} long life, 105°C

KXE Series

- For LED light circuits and other long life applications
- Rated voltage range : 160 to 400 V_{dc} , Capacitance range : 1.0 to 33μF
- Endurance with ripple current : 10,000 to 12,000 hours at 105°C
- Non solvent resistant type
- RoHS Compliant

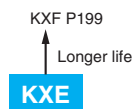

SPECIFICATIONS

Items	Characteristics		
Category	-40 to +105°C		
Temperature Range			
Rated Voltage Range	160 to 400V _{dc}		
Capacitance Tolerance	±20% (M) (at 20°C, 120Hz)		
Leakage Current		After 1 minute	After 5 minutes
	CV ≤ 1,000	I=0.1CV+40	I=0.03CV+15
	CV > 1,000	I=0.04CV+100	I=0.02CV+25
	Where, I : Max. leakage current (μA), C : Nominal capacitance (μF), V : Rated voltage (V) (at 20°C)		
Dissipation Factor (tan δ)	Rated voltage (V _{dc})	160 to 400V	(at 20°C, 120Hz)
	tan δ (Max.)	0.24	
Low Temperature Characteristics (Max. Impedance Ratio)	Rated voltage (V _{dc})	160 to 400V	(at 120Hz)
	Z(-25°C)/Z(+20°C)	4	
	Z(-40°C)/Z(+20°C)	6	
Endurance	The following specifications shall be satisfied when the capacitors are restored to 20°C after subjected to DC voltage with the rated ripple current is applied (the peak voltage shall not exceed the rated voltage) for 10,000 hours (12,000 hours for φ 10 × 16L) at 105°C.		
	Capacitance change	≤ ±30% of the initial value	
	D.F. (tan δ)	≤ 300% of the initial specified value	
	Leakage current	≤ The initial specified value	
Shelf Life	The following specifications shall be satisfied when the capacitors are restored to 20°C after exposing them for 1,000 hours at 105°C without voltage applied. Before the measurement, the capacitor shall be preconditioned by applying voltage according to Item 4.1 of JIS C 5101-4.		
	Capacitance change	≤ ±30% of the initial value	
	D.F. (tan δ)	≤ 300% of the initial specified value	
	Leakage current	≤ 500% of the initial specified value	

DIMENSIONS [mm]

- Terminal Code : E

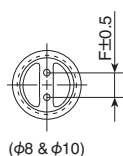
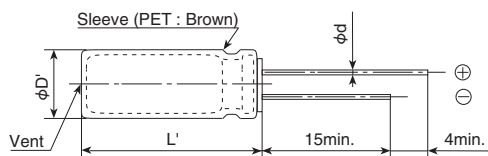

Gas escape end seal

φD	8	10
φd	0.6	0.6
F	3.5	5.0
φD'	φD+0.5max.	
L'	L+2.0max.	L+1.5max.

PART NUMBERING SYSTEM



- Supplement code
- Size code
- Capacitance tolerance code
- Capacitance code (ex. 3.3μF:3R3,33μF:330)
- Lead forming-taping code
- Terminal code
- Voltage code (ex. 160V:161,400V:401)
- Series code
- Category

Please refer to "Product code guide (radial lead type)"

RATED RIPPLE CURRENT MULTIPLIERS

- Frequency Multipliers

Capacitance(μF)	Frequency(Hz)			
	120	1k	10k	100k
1.0 to 33	1.00	1.75	2.25	2.50

The endurance of capacitors is reduced with internal heating produced by ripple current at the rate of halving the lifetime with every 5°C rise. When long life performance is required in actual use, the rms ripple current has to be reduced.

Return Group Chart



MINIATURE ALUMINUM ELECTROLYTIC CAPACITORS

160 to 400V_{dc} long life, 105°C

KXESeries

◆STANDARD RATINGS

WV (V _{dc})	Cap (μF)	Case size φD×L(mm)	tan δ	Rated ripple current(mArms/105°C)		Part No.
				120Hz	100kHz	
160	10	8 × 11.5	0.24	55	137	EKXE161E□□100MHB5D
	15	8 × 15	0.24	75	187	EKXE161E□□150MH15D
	15	10 × 12.5	0.24	80	200	EKXE161E□□150MJC5S
	22	10 × 12.5	0.24	95	237	EKXE161E□□220MJC5S
	27	10 × 16	0.24	105	262	EKXE161E□□270MJ16S
	33	10 × 16	0.24	130	325	EKXE161E□□330MJ16S
200	10	8 × 11.5	0.24	55	137	EKXE201E□□100MHB5D
	12	8 × 15	0.24	70	175	EKXE201E□□120MH15D
	12	10 × 12.5	0.24	70	175	EKXE201E□□120MJC5S
	15	10 × 16	0.24	90	225	EKXE201E□□150MJ16S
	18	10 × 12.5	0.24	85	212	EKXE201E□□180MJC5S
	27	10 × 16	0.24	120	300	EKXE201E□□270MJ16S
250	6.8	8 × 11.5	0.24	45	112	EKXE251E□□6R8MHB5D
	10	8 × 15	0.24	60	150	EKXE251E□□100MH15D
400	1.0	8 × 11.5	0.24	25	62	EKXE401E□□1R0MHB5D
	2.2	8 × 11.5	0.24	40	100	EKXE401E□□2R2MHB5D
	2.7	8 × 11.5	0.24	45	112	EKXE401E□□2R7MHB5D
	3.3	8 × 11.5	0.24	50	125	EKXE401E□□3R3MHB5D
	3.3	10 × 12.5	0.24	60	150	EKXE401E□□3R3MJC5S
	3.9	8 × 15	0.24	65	162	EKXE401E□□3R9MH15D
	4.7	10 × 16	0.24	90	225	EKXE401E□□4R7MJ16S
	5.6	10 × 16	0.24	100	250	EKXE401E□□5R6MJ16S
	6.8	10 × 12.5	0.24	85	212	EKXE401E□□6R8MJC5S
	6.8	10 × 16	0.24	115	287	EKXE401E□□6R8MJ16S

□□ : Enter the appropriate lead forming or taping code.

Return Group Chart



MINIATURE ALUMINUM ELECTROLYTIC CAPACITORS

Long life for $\phi 5$ to $\phi 8$ product, 105°C

LE Series

- Suitable for long life products
- Downsize and long life
- Endurance with ripple current : 10,000 hours at 105°C
- Case size range : $\phi 5 \times 11L$ to $\phi 8 \times 11.5L$
- Solvent resistant type (see PRECAUTIONS AND GUIDELINES)
- RoHS Compliant



◆ SPECIFICATION

Items	Characteristics								
Category	-40 to +105°C								
Temperature Range	-40 to +105°C								
Rated Voltage Range	10 to 100V _{dc}								
Capacitance Tolerance	±20% (M) (at 20°C, 120Hz)								
Leakage Current	I=0.01CV or 3μA, whichever is greater. Where, I : Max. leakage current (μA), C : Nominal capacitance (μF), V : Rated voltage (V) (at 20°C after 2 minutes)								
Dissipation Factor (tan δ)	Rated voltage (V _{dc})	10V	16V	25V	35V	50V	63V	100V	(at 20°C, 120Hz)
	tan δ (Max.)	0.45	0.35	0.30	0.22	0.19	0.17	0.15	
Low Temperature Characteristics (Max. Impedance Ratio)	Rated voltage (V _{dc})	10V	16V	25V	35V	50V	63V	100V	(at 120Hz)
	Z(-25°C)/Z(20°C)	8	6	4	4	3	3	3	
Endurance	The following specifications shall be satisfied when the capacitors are restored to 20°C after subjected to DC voltage with the rated ripple current is applied (the peak voltage shall not exceed the rated voltage) for 10,000 hours at 105°C.								
	Capacitance change	≤ ±25% of the initial value							
	D.F. (tan δ)	≤ 300% of the initial specified value							
	Leakage current	≤ The initial specified value							
Shelf Life	The following specifications shall be satisfied when the capacitors are restored to 20°C after exposing them for 1,000 hours at 105°C without voltage applied. Before the measurement, the capacitor shall be preconditioned by applying voltage according to Item 4.1 of JIS C 5101-4.								
	Capacitance change	≤ ±25% of the initial value							
	D.F. (tan δ)	≤ 300% of the initial specified value							
	Leakage current	≤ The initial specified value							

◆ DIMENSIONS [mm]

● Terminal Code : E

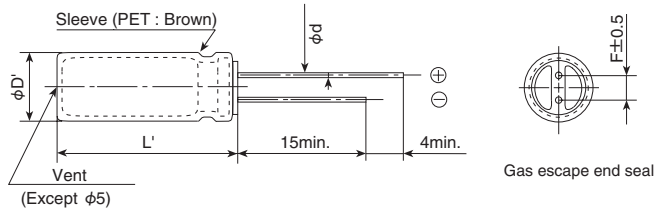

φD	5	6.3	8
φd	0.5	0.5	0.6
F	2.0	2.5	3.5
φD'	φD+0.5max.		
L'	L+1.5max.		

◆ PART NUMBERING SYSTEM

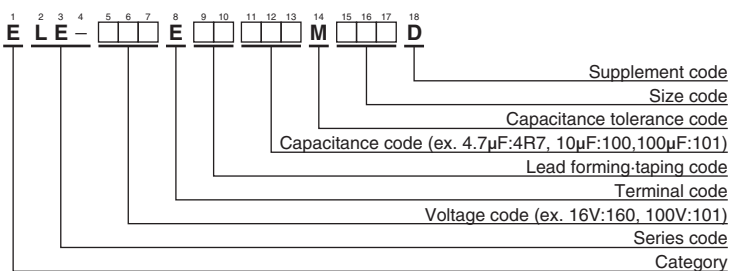

Please refer to "Product code guide (radial lead type)"

Return Group Chart



MINIATURE ALUMINUM ELECTROLYTIC CAPACITORS

Long life for $\phi 5$ to $\phi 8$ product, 105°C

LE Series

◆ STANDARD RATINGS

WV (V _{dc})	Cap (μF)	Case size φD×L(mm)	tan δ	Rated ripple current (mA _{rms} /105°C, 100kHz)	Part No.
10	100	5 × 11	0.45	130	ELE-100E□□101ME11D
	220	6.3 × 11	0.45	210	ELE-100E□□221MF11D
	330	8 × 11.5	0.45	330	ELE-100E□□331MHB5D
16	47	5 × 11	0.35	130	ELE-160E□□470ME11D
	100	6.3 × 11	0.35	210	ELE-160E□□101MF11D
	220	8 × 11.5	0.35	330	ELE-160E□□221MHB5D
25	33	5 × 11	0.30	130	ELE-250E□□330ME11D
	47	5 × 11	0.30	130	ELE-250E□□470ME11D
	100	6.3 × 11	0.30	210	ELE-250E□□101MF11D
35	33	5 × 11	0.22	130	ELE-350E□□330ME11D
	47	6.3 × 11	0.22	210	ELE-350E□□470MF11D
	100	8 × 11.5	0.22	330	ELE-350E□□101MHB5D
50	1.0	5 × 11	0.19	25	ELE-500E□□1R0ME11D
	2.2	5 × 11	0.19	35	ELE-500E□□2R2ME11D
	3.3	5 × 11	0.19	70	ELE-500E□□3R3ME11D
	4.7	5 × 11	0.19	80	ELE-500E□□4R7ME11D
	10	5 × 11	0.19	90	ELE-500E□□100ME11D
	22	5 × 11	0.19	110	ELE-500E□□220ME11D
	33	6.3 × 11	0.19	190	ELE-500E□□330MF11D
	47	6.3 × 11	0.19	190	ELE-500E□□470MF11D
100	8 × 11.5	0.19	270	ELE-500E□□101MHB5D	
63	10	5 × 11	0.17	80	ELE-630E□□100ME11D
	22	6.3 × 11	0.17	170	ELE-630E□□220MF11D
	33	6.3 × 11	0.17	170	ELE-630E□□330MF11D
	47	8 × 11.5	0.17	240	ELE-630E□□470MHB5D
100	1.0	5 × 11	0.15	40	ELE-101E□□1R0ME11D
	2.2	5 × 11	0.15	50	ELE-101E□□2R2ME11D
	3.3	5 × 11	0.15	60	ELE-101E□□3R3ME11D
	4.7	5 × 11	0.15	70	ELE-101E□□4R7ME11D
	10	6.3 × 11	0.15	150	ELE-101E□□100MF11D
	22	8 × 11.5	0.15	230	ELE-101E□□220MHB5D

□□ : Enter the appropriate lead forming or taping code.

◆ RATED RIPPLE CURRENT MULTIPLIERS

⊙ Frequency Multipliers

Capacitance(μF)	Frequency(Hz)			
	120	1k	10k	100k
1.0 to 10	0.42	0.60	0.80	1.00
22 to 33	0.55	0.75	0.90	1.00
47 to 330	0.70	0.85	0.95	1.00

The endurance of capacitors is reduced with internal heating produced by ripple current at the rate of halving the lifetime with every 5°C rise. When long life performance is required in actual use, the rms ripple current has to be reduced.

Return Group Chart



MINIATURE ALUMINUM ELECTROLYTIC CAPACITORS

Long life for $\phi 4$ to $\phi 8$ product, 105°C

FL Series

- Long life for $\phi 4 \times 5L$ to $\phi 8 \times 7L$ mm range
- Endurance with ripple current : 3,000 hours at 105°C
- Suitable for long life products
- Solvent resistant type (see PRECAUTIONS AND GUIDELINES)
- RoHS Compliant



◆ SPECIFICATIONS

Items	Characteristics	
Category	-40 to +105°C	
Temperature Range		
Rated Voltage Range	6.3 to 50V _{dc}	
Capacitance Tolerance	±20% (M) (at 20°C, 120Hz)	
Leakage Current	I=0.03CV or 3μA, whichever is greater. Where, I : Max. leakage current (μA), C : Nominal capacitance (μF), V : Rated voltage (V) (at 20°C after 2 minutes)	
Dissipation Factor (tan δ)	Rated voltage (V _{dc})	6.3V 10V 16V 25V 35V 50V
	tan δ (Max.)	0.50 0.40 0.35 0.30 0.25 0.25 (at 20°C, 120Hz)
Endurance	The following specifications shall be satisfied when the capacitors are restored to 20°C after subjected to DC voltage with the rated ripple current is applied (the peak voltage shall not exceed the rated voltage) for 3,000 hours at 105°C.	
	Capacitance change	≤ ±30% of the initial value
	D.F. (tan δ)	≤300% of the initial specified value
	Leakage current	≤The initial specified value
Shelf Life	The following specifications shall be satisfied when the capacitors are restored to 20°C after exposing them for 1,000 hours at 105°C without voltage applied. Before the measurement, the capacitor shall be preconditioned by applying voltage according to Item 4.1 of JIS C 5101-4.	
	Capacitance change	≤ ±20% of the initial value
	D.F. (tan δ)	≤200% of the initial specified value
	Leakage current	≤The initial specified value

◆ DIMENSIONS [mm]

- Terminal Code : E

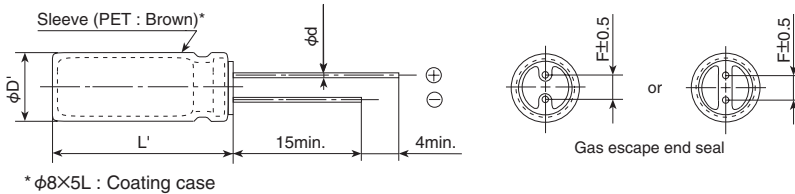

* $\phi 8 \times 5L$: Coating case

5mm Height

φD	4	5	6.3	8
φd	0.45	0.45	0.45	0.45
F	1.5	2.0	2.5	2.5
φD'	φD+0.5max.			
L'	L+1.0max.			

7mm Height

φD	4	5	6.3	8
φd	0.45	0.45	0.45	0.45
F	1.5	2.0	2.5	3.5
φD'	φD+0.5max.			
L'	L+1.0max.			

◆ PART NUMBERING SYSTEM

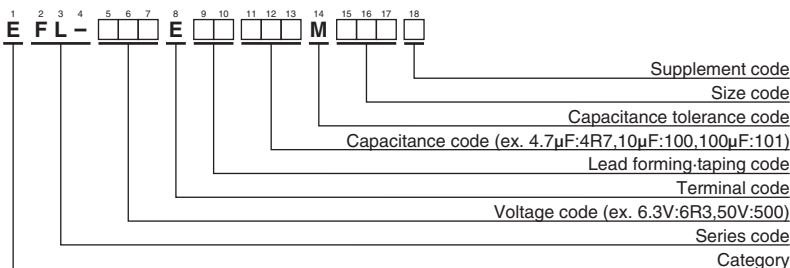

Please refer to "Product code guide (radial lead type)"

Return Group Chart



MINIATURE ALUMINUM ELECTROLYTIC CAPACITORS

Long life for $\phi 4$ to $\phi 8$ product, 105°C

FL Series

◆STANDARD RATINGS

WV (V _{dc})	Cap (μF)	Case size φD×L(mm)	tan δ	Impedance (Ω max./20°C, 100kHz)	Rated ripple current (mA rms/105°C, 100kHz)	Part No.
6.3	33	4×5	0.50	5.4	37	EFL-6R3E□□330MD05D
	47	4×7	0.50	4.5	44	EFL-6R3E□□470MD07D
	56	5×5	0.50	3.1	57	EFL-6R3E□□560ME05D
	82	5×7	0.50	2.5	70	EFL-6R3E□□820ME07D
	100	6.3×5	0.50	1.7	82	EFL-6R3E□□101MF05D
	150	6.3×7	0.50	1.3	116	EFL-6R3E□□151MF07D
	220	8×5	0.50	1.5	110	EFL-6R3E□□221MH05G
10	270	8×7	0.50	0.90	162	EFL-6R3E□□271MH07D
	22	4×5	0.40	5.4	37	EFL-100E□□220MD05D
	33	4×7	0.40	4.5	44	EFL-100E□□330MD07D
	33	5×5	0.40	3.1	57	EFL-100E□□330ME05D
	47	5×7	0.40	2.5	70	EFL-100E□□470ME07D
	68	6.3×5	0.40	1.7	82	EFL-100E□□680MF05D
	100	6.3×7	0.40	1.3	116	EFL-100E□□101MF07D
16	150	8×5	0.40	1.5	110	EFL-100E□□151MH05G
	220	8×7	0.40	0.90	162	EFL-100E□□221MH07D
	15	4×5	0.35	5.4	37	EFL-160E□□150MD05D
	22	4×7	0.35	4.5	44	EFL-160E□□220MD07D
	22	5×5	0.35	3.1	57	EFL-160E□□220ME05D
	33	5×7	0.35	2.5	70	EFL-160E□□330ME07D
	47	6.3×5	0.35	1.7	82	EFL-160E□□470MF05D
25	68	6.3×7	0.35	1.3	116	EFL-160E□□680MF07D
	100	8×5	0.35	1.5	110	EFL-160E□□101MH05G
	150	8×7	0.35	0.90	162	EFL-160E□□151MH07D
	10	4×5	0.30	5.4	37	EFL-250E□□100MD05D
	15	4×7	0.30	4.5	44	EFL-250E□□150MD07D
	15	5×5	0.30	3.1	57	EFL-250E□□150ME05D
	22	5×7	0.30	2.5	70	EFL-250E□□220ME07D
35	33	6.3×5	0.30	1.7	82	EFL-250E□□330MF05D
	56	6.3×7	0.30	1.3	116	EFL-250E□□560MF07D
	68	8×5	0.30	1.5	110	EFL-250E□□680MH05G
	100	8×7	0.30	0.90	162	EFL-250E□□101MH07D
	4.7	4×5	0.25	5.4	37	EFL-350E□□4R7MD05D
	6.8	4×7	0.25	4.5	44	EFL-350E□□6R8MD07D
	10	5×5	0.25	3.1	57	EFL-350E□□100ME05D
50	10	5×7	0.25	2.5	70	EFL-350E□□100ME07D
	22	6.3×5	0.25	1.7	82	EFL-350E□□220MF05D
	22	6.3×7	0.25	1.3	116	EFL-350E□□220MF07D
	33	8×5	0.25	1.5	110	EFL-350E□□330MH05G
	47	8×7	0.25	0.90	162	EFL-350E□□470MH07D
	1.0	4×5	0.25	19	18	EFL-500E□□1R0MD05D
	2.2	4×5	0.25	14	22	EFL-500E□□2R2MD05D
3.3	4×5	0.25	11	26	EFL-500E□□3R3MD05D	
100	4.7	4×7	0.25	9.0	30	EFL-500E□□4R7MD07D
	4.7	5×5	0.25	6.0	40	EFL-500E□□4R7ME05D
	6.8	5×7	0.25	4.8	50	EFL-500E□□6R8ME07D
	10	6.3×5	0.25	2.9	63	EFL-500E□□100MF05D
	15	6.3×7	0.25	2.2	90	EFL-500E□□150MF07D
	22	8×5	0.25	2.6	84	EFL-500E□□220MH05G
	22	8×7	0.25	1.6	120	EFL-500E□□220MH07D

□ □ : Enter the appropriate lead forming or taping code.

◆RATED RIPPLE CURRENT MULTIPLIERS

● Frequency Multipliers

Capacitance(μF)	Frequency(Hz)			
	120	1k	10k	100k
to 3.3	0.20	0.66	0.90	1.00
4.7 to 6.8	0.35	0.70	0.90	1.00
10 to 150	0.40	0.75	0.90	1.00
220 to 270	0.50	0.85	0.94	1.00

The endurance of capacitors is reduced with internal heating produced by ripple current at the rate of halving the lifetime with every 5°C rise. When long life performance is required in actual use, the rms ripple current has to be reduced.



GPA Series

- Guaranteed short time at 150°C
- Downsized, low impedance and high-ripple current version of GXE series
- Specified ESR after endurance test
- For high ripple current automotive applications.
(Direct fuel injection and electric power steering etc.)
- Endurance with ripple current : 3,000 to 5,000 hours at 125°C
- Solvent resistant type (see PRECAUTIONS AND GUIDELINES)
- RoHS Compliant
- AEC-Q200 compliant : Please contact Chemi-Con for more details, test data, information.



◆ SPECIFICATIONS

Items	Characteristics						
Category Temperature Range	-40 to +125°C						
Rated Voltage Range	25 to 100V _{dc}						
Capacitance Tolerance	±20% (M) (at 20°C, 120Hz)						
Leakage Current	I=0.03CV or 4μA, whichever is greater. Where, I : Max. leakage current (μA), C : Nominal capacitance (μF), V : Rated voltage (V) (at 20°C, 1 minute)						
Dissipation Factor (tan δ)	Rated voltage (V _{dc})	25V	35V	50V	63V	80V	100V
	tan δ (Max.)	0.14	0.12	0.10	0.10	0.08	0.08
	When nominal capacitance exceeds 1,000μF, add 0.02 to the value above for each 1,000μF increase. (at 20°C, 120Hz)						
Low Temperature Characteristics (Max. Impedance Ratio)	Rated voltage (V _{dc})	25V	35V	50V	63V	80V	100V
	Z(-25°C)/Z(+20°C)	2	2	2	2	2	2
	Z(-40°C)/Z(+20°C)	4	4	4	4	4	4
(at 120Hz)							
Endurance 1	The following specifications shall be satisfied when the capacitors are restored to 20°C after subjected to DC voltage with the rated ripple current is applied (the peak voltage shall not exceed the rated voltage) for 5,000 hours (3,000 hours for 25L and less) at 125°C.						
	Capacitance change	≤ ±30% of the initial value					
	D.F. (tan δ)	≤300% of the initial specified value					
	Leakage current	≤The initial specified value					
Endurance 2	The following specifications shall be satisfied when the capacitors are restored to 20°C after the test condition that the rated voltage is applied for 100 hours at 150°C and DC voltage with the rated ripple current is applied (the peak voltage shall not exceed the rated voltage) for 4,500 hours (2,500 hours for 25L and less) at 125°C.						
	Capacitance change	≤ ±30% of the initial value					
	D.F. (tan δ)	≤300% of the initial specified value					
	Leakage current	≤The initial specified value					
Shelf Life	The following specifications shall be satisfied when the capacitors are restored to 20°C after exposing them for 1,000 hours at 125°C without voltage applied. Before the measurement, the capacitor shall be preconditioned by applying voltage according to Item 4.1 of JIS C 5101-4.						
	Capacitance change	≤ ±30% of the initial value					
	D.F. (tan δ)	≤300% of the initial specified value					
	Leakage current	≤The initial specified value					

◆ DIMENSIONS [mm]

● Terminal Code : E

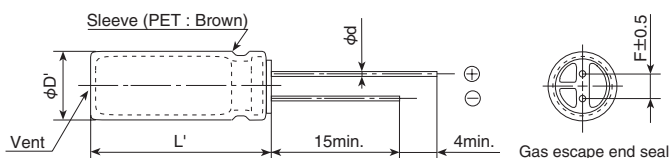

φD	12.5	14.5	16	18
φd	0.6	0.8	0.8	0.8
F	5.0	7.5	7.5	7.5
φD'	φD+0.5max.			
L'	L+1.5max.			

◆ PART NUMBERING SYSTEM

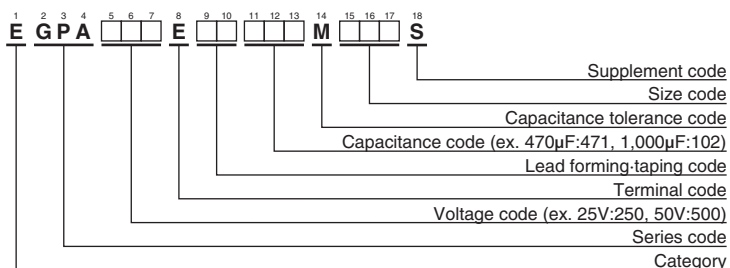

Please refer to "Product code guide (radial lead type)"

Return Group Chart



MINIATURE ALUMINUM ELECTROLYTIC CAPACITORS

Long life, Downsized, 125°C

GPASeries

◆STANDARD RATINGS

WV (V _{dc})	Cap (μF)	Case size φD×L(mm)	ESR (Initial) (Ω max./100kHz)		ESR (End of Life) (Ω max./100kHz)		Rated ripple current (mArms/125°C, 100kHz)	Part No.
			20°C	-40°C	20°C	-40°C		
25	1,200	12.5×20	0.044	0.22	0.18	2.2	1,820	EGPA250E□□122MK20S
	1,500	14.5×20	0.037	0.19	0.11	1.3	2,100	EGPA250E□□152MU20S
	1,800	12.5×25	0.033	0.17	0.13	1.6	2,400	EGPA250E□□182MK25S
	1,800	16×20	0.034	0.17	0.10	1.3	2,280	EGPA250E□□182ML20S
	2,200	12.5×30	0.029	0.13	0.11	1.3	2,560	EGPA250E□□222MK30S
	2,200	14.5×25	0.028	0.14	0.080	0.90	2,800	EGPA250E□□222MU25S
	2,700	12.5×35	0.024	0.11	0.090	0.80	2,970	EGPA250E□□272MK35S
	2,700	14.5×30	0.023	0.10	0.070	0.70	3,060	EGPA250E□□272MU30S
	2,700	16×25	0.026	0.13	0.080	1.1	3,100	EGPA250E□□272ML25S
	2,700	18×20	0.032	0.16	0.090	0.60	2,490	EGPA250E□□272MM20S
	3,300	12.5×40	0.021	0.095	0.080	0.50	3,600	EGPA250E□□332MK40S
	3,300	14.5×35	0.021	0.095	0.060	0.70	3,380	EGPA250E□□332MU35S
	3,300	16×30	0.023	0.10	0.070	0.90	3,160	EGPA250E□□332ML30S
	3,900	16×35	0.020	0.090	0.060	0.70	3,590	EGPA250E□□392ML35S
	3,900	18×25	0.024	0.12	0.070	0.50	3,200	EGPA250E□□392MM25S
	4,700	14.5×40	0.018	0.081	0.050	0.50	4,000	EGPA250E□□472MU40S
	4,700	18×30	0.022	0.099	0.080	0.60	3,390	EGPA250E□□472MM30S
	5,600	16×40	0.017	0.077	0.040	0.60	4,300	EGPA250E□□562ML40S
5,600	18×35	0.019	0.086	0.070	0.50	4,200	EGPA250E□□562MM35S	
6,800	18×40	0.016	0.072	0.030	0.40	4,600	EGPA250E□□682MM40S	
35	680	12.5×20	0.044	0.22	0.18	2.2	1,820	EGPA350E□□681MK20S
	1,000	12.5×25	0.033	0.17	0.13	1.6	2,400	EGPA350E□□102MK25S
	1,000	14.5×20	0.037	0.19	0.11	1.3	2,100	EGPA350E□□102MU20S
	1,200	12.5×30	0.029	0.13	0.11	1.3	2,560	EGPA350E□□122MK30S
	1,200	14.5×25	0.028	0.14	0.080	0.90	2,800	EGPA350E□□122MU25S
	1,200	16×20	0.034	0.17	0.10	1.3	2,280	EGPA350E□□122ML20S
	1,500	12.5×35	0.024	0.11	0.090	0.80	2,970	EGPA350E□□152MK35S
	1,500	14.5×30	0.023	0.10	0.070	0.70	3,060	EGPA350E□□152MU30S
	1,500	18×20	0.032	0.16	0.090	0.60	2,490	EGPA350E□□152MM20S
	1,800	12.5×40	0.021	0.095	0.080	0.50	3,600	EGPA350E□□182MK40S
	1,800	16×25	0.026	0.13	0.080	1.1	3,100	EGPA350E□□182ML25S
	2,200	14.5×35	0.021	0.095	0.060	0.70	3,380	EGPA350E□□222MU35S
	2,200	16×30	0.023	0.10	0.070	0.90	3,160	EGPA350E□□222ML30S
	2,200	18×25	0.024	0.12	0.070	0.50	3,200	EGPA350E□□222MM25S
	2,700	14.5×40	0.018	0.081	0.050	0.50	4,000	EGPA350E□□272MU40S
	2,700	16×35	0.020	0.090	0.060	0.70	3,590	EGPA350E□□272ML35S
	2,700	18×30	0.022	0.099	0.080	0.60	3,390	EGPA350E□□272MM30S
	3,300	16×40	0.017	0.077	0.040	0.60	4,300	EGPA350E□□332ML40S
3,300	18×35	0.019	0.086	0.070	0.50	4,200	EGPA350E□□332MM35S	
4,700	18×40	0.016	0.072	0.030	0.40	4,600	EGPA350E□□472MM40S	
50	470	12.5×20	0.065	0.33	0.18	2.2	1,500	EGPA500E□□471MK20S
	560	14.5×20	0.055	0.28	0.11	1.3	1,740	EGPA500E□□561MU20S
	680	12.5×25	0.048	0.24	0.13	1.6	1,900	EGPA500E□□681MK25S
	680	16×20	0.043	0.22	0.10	1.3	2,040	EGPA500E□□681ML20S
	820	12.5×30	0.041	0.18	0.11	1.3	2,150	EGPA500E□□821MK30S
	820	14.5×25	0.040	0.20	0.080	0.90	2,190	EGPA500E□□821MU25S
	1,000	12.5×35	0.034	0.15	0.090	0.80	2,510	EGPA500E□□102MK35S
	1,000	14.5×30	0.036	0.16	0.070	0.70	2,470	EGPA500E□□102MU30S
	1,000	16×25	0.031	0.16	0.080	1.1	2,620	EGPA500E□□102ML25S
	1,000	18×20	0.039	0.20	0.090	0.60	2,240	EGPA500E□□102MM20S
	1,200	12.5×40	0.028	0.13	0.080	0.50	2,870	EGPA500E□□122MK40S
	1,200	14.5×35	0.029	0.13	0.060	0.70	2,840	EGPA500E□□122MU35S
	1,200	16×30	0.027	0.13	0.070	0.90	2,940	EGPA500E□□122ML30S
	1,200	18×25	0.029	0.15	0.070	0.50	2,750	EGPA500E□□122MM25S
	1,500	16×35	0.023	0.10	0.060	0.70	3,300	EGPA500E□□152ML35S
	1,800	14.5×40	0.024	0.11	0.050	0.50	3,230	EGPA500E□□182MU40S
	1,800	18×30	0.026	0.12	0.080	0.60	3,140	EGPA500E□□182MM30S
	2,200	16×40	0.020	0.090	0.040	0.60	3,720	EGPA500E□□222ML40S
2,200	18×35	0.022	0.10	0.070	0.50	3,510	EGPA500E□□222MM35S	
2,700	18×40	0.018	0.080	0.030	0.40	3,940	EGPA500E□□272MM40S	

□□ : Enter the appropriate lead forming or taping code.



GPA Series

◆ STANDARD RATINGS

WV (V _{dc})	Cap (μF)	Case size φD×L(mm)	ESR (Initial) (Ω max./100kHz)		ESR (End of Life) (Ω max./100kHz)		Rated ripple current (mArms/125°C, 100kHz)	Part No.
			20°C	-40°C	20°C	-40°C		
63	470	16×20	0.085	0.58	0.19	3.0	1,790	EGPA630E□□471ML20S
	680	16×25	0.061	0.48	0.14	2.0	2,030	EGPA630E□□681ML25S
	680	18×20	0.070	0.49	0.19	3.0	1,910	EGPA630E□□681MM20S
	820	16×30	0.053	0.41	0.090	1.3	2,330	EGPA630E□□821ML30S
	1,000	16×35	0.044	0.33	0.070	0.90	2,580	EGPA630E□□102ML35S
	1,000	18×25	0.049	0.34	0.14	2.0	2,280	EGPA630E□□102MM25S
	1,200	16×40	0.036	0.26	0.060	0.80	2,900	EGPA630E□□122ML40S
	1,200	18×30	0.041	0.26	0.090	1.3	2,580	EGPA630E□□122MM30S
	1,500	18×35	0.035	0.21	0.070	0.90	2,890	EGPA630E□□152MM35S
	1,800	18×40	0.030	0.18	0.060	0.80	3,210	EGPA630E□□182MM40S
80	330	16×20	0.085	0.58	0.19	3.0	1,790	EGPA800E□□331ML20S
	470	16×25	0.061	0.48	0.14	2.0	2,030	EGPA800E□□471ML25S
	470	18×20	0.070	0.49	0.19	3.0	1,910	EGPA800E□□471MM20S
	560	16×30	0.053	0.41	0.090	1.3	2,330	EGPA800E□□561ML30S
	560	18×25	0.049	0.34	0.14	2.0	2,280	EGPA800E□□561MM25S
	680	16×35	0.044	0.33	0.070	0.90	2,580	EGPA800E□□681ML35S
	680	18×30	0.041	0.26	0.090	1.3	2,580	EGPA800E□□681MM30S
	820	16×40	0.036	0.26	0.060	0.80	2,900	EGPA800E□□821ML40S
	820	18×35	0.035	0.21	0.070	0.90	2,890	EGPA800E□□821MM35S
	1,200	18×40	0.030	0.18	0.060	0.80	3,210	EGPA800E□□122MM40S
100	200	16×20	0.11	0.88	0.25	3.9	1,580	EGPA101E□□201ML20S
	270	18×20	0.091	0.73	0.22	3.9	1,690	EGPA101E□□271MM20S
	300	16×25	0.079	0.72	0.18	2.7	1,990	EGPA101E□□301ML25S
	360	16×30	0.068	0.62	0.13	1.9	2,250	EGPA101E□□361ML30S
	390	18×25	0.064	0.50	0.15	2.7	2,110	EGPA101E□□391MM25S
	470	16×35	0.056	0.50	0.090	1.3	2,500	EGPA101E□□471ML35S
	510	18×30	0.054	0.39	0.13	1.9	2,410	EGPA101E□□511MM30S
	560	16×40	0.046	0.39	0.080	1.1	2,700	EGPA101E□□561ML40S
	620	18×35	0.044	0.32	0.090	1.3	2,690	EGPA101E□□621MM35S
	750	18×40	0.039	0.27	0.080	1.1	2,880	EGPA101E□□751MM40S

□□ : Enter the appropriate lead forming or taping code.

◆ RATED RIPPLE CURRENT MULTIPLIERS

● Frequency Multipliers

Capacitance(μF)	Frequency(Hz)			
	120	1k	10k	100k
200	0.40	0.82	0.93	1.00
270 to 560	0.50	0.85	0.94	1.00
620 to 1,800	0.60	0.87	0.95	1.00
2,200 to 3,900	0.75	0.90	0.95	1.00
4,700 to 6,800	0.85	0.95	0.98	1.00

The endurance of capacitors is reduced with internal heating produced by ripple current at the rate of halving the lifetime with every 5°C rise. When long life performance is required in actual use, the rms ripple current has to be reduced.

Please contact us for lifetime estimation.

Return Group Chart



MINIATURE ALUMINUM ELECTROLYTIC CAPACITORS

Vibration resistant structure, 125°C

GVA Series

- Structure of higher vibration by GPA series (acceleration 392m/s², 40G)
- Guaranteed short time at 150°C
- Designed for electric power steering and ECU(include engine control, direct fuel injection) etc.
- Rated voltage range : 25 to 100V, Capacitance range : 430 to 5,100μF
- Solvent resistant type
- RoHS Compliant
- AEC-Q200 compliant : Please contact Chemi-Con for more details, test data, information.

GPA
P207

Vibration resistance

GVA



◆SPECIFICATIONS

Items	Characteristics																					
Category	-40 to +125°C																					
Temperature Range	-40 to +125°C																					
Rated Voltage Range	25 to 100V _{dc}																					
Capacitance Tolerance	±20% (M) (at 20°C, 120Hz)																					
Leakage Current	I=0.03CV or 4μA, whichever is greater. Where, I : Max. leakage current (μA), C : Nominal capacitance (μF), V : Rated voltage (V) (at 20°C, 1 minute)																					
Dissipation Factor (tan δ)	<table border="1"> <tr> <td>Rated voltage (V_{dc})</td> <td>25V</td> <td>35V</td> <td>50V</td> <td>63V</td> <td>80V</td> <td>100V</td> </tr> <tr> <td>tan δ (Max.)</td> <td>0.14</td> <td>0.12</td> <td>0.10</td> <td>0.10</td> <td>0.08</td> <td>0.08</td> </tr> </table> <p>When nominal capacitance exceeds 1,000μF, add 0.02 to the value above for each 1,000μF increase. (at 20°C, 120Hz)</p>	Rated voltage (V _{dc})	25V	35V	50V	63V	80V	100V	tan δ (Max.)	0.14	0.12	0.10	0.10	0.08	0.08							
Rated voltage (V _{dc})	25V	35V	50V	63V	80V	100V																
tan δ (Max.)	0.14	0.12	0.10	0.10	0.08	0.08																
Low Temperature Characteristics (Max. Impedance Ratio)	<table border="1"> <tr> <td>Rated voltage (V_{dc})</td> <td>25V</td> <td>35V</td> <td>50V</td> <td>63V</td> <td>80V</td> <td>100V</td> </tr> <tr> <td>Z(-25°C)/Z(+20°C)</td> <td>2</td> <td>2</td> <td>2</td> <td>2</td> <td>2</td> <td>2</td> </tr> <tr> <td>Z(-40°C)/Z(+20°C)</td> <td>4</td> <td>4</td> <td>4</td> <td>4</td> <td>4</td> <td>4</td> </tr> </table> <p>(at 120Hz)</p>	Rated voltage (V _{dc})	25V	35V	50V	63V	80V	100V	Z(-25°C)/Z(+20°C)	2	2	2	2	2	2	Z(-40°C)/Z(+20°C)	4	4	4	4	4	4
Rated voltage (V _{dc})	25V	35V	50V	63V	80V	100V																
Z(-25°C)/Z(+20°C)	2	2	2	2	2	2																
Z(-40°C)/Z(+20°C)	4	4	4	4	4	4																
Endurance 1	The following specifications shall be satisfied when the capacitors are restored to 20°C after subjected to DC voltage with the rated ripple current is applied (the peak voltage shall not exceed the rated voltage) for 5,000 hours at 125 °C. <table border="1"> <tr> <td>Capacitance change</td> <td>≤ ±30% of the initial value</td> </tr> <tr> <td>D.F. (tan δ)</td> <td>≤300% of the initial specified value</td> </tr> <tr> <td>Leakage current</td> <td>≤The initial specified value</td> </tr> </table>	Capacitance change	≤ ±30% of the initial value	D.F. (tan δ)	≤300% of the initial specified value	Leakage current	≤The initial specified value															
Capacitance change	≤ ±30% of the initial value																					
D.F. (tan δ)	≤300% of the initial specified value																					
Leakage current	≤The initial specified value																					
Endurance 2	The following specifications shall be satisfied when the capacitors are restored to 20°C after the test condition that the rated voltage is applied for 100 hours at 150°C and DC voltage with the rated ripple current is applied (the peak voltage shall not exceed the rated voltage) for 4,500 hours at 125°C. <table border="1"> <tr> <td>Capacitance change</td> <td>≤ ±30% of the initial value</td> </tr> <tr> <td>D.F. (tan δ)</td> <td>≤300% of the initial specified value</td> </tr> <tr> <td>Leakage current</td> <td>≤The initial specified value</td> </tr> </table>	Capacitance change	≤ ±30% of the initial value	D.F. (tan δ)	≤300% of the initial specified value	Leakage current	≤The initial specified value															
Capacitance change	≤ ±30% of the initial value																					
D.F. (tan δ)	≤300% of the initial specified value																					
Leakage current	≤The initial specified value																					
Shelf Life	The following specifications shall be satisfied when the capacitors are restored to 20°C after exposing them for 1,000 hours at 125°C without voltage applied. Before the measurement, the capacitor shall be preconditioned by applying voltage according to Item 4.1 of JIS C 5101-4. <table border="1"> <tr> <td>Capacitance change</td> <td>≤ ±30% of the initial value</td> </tr> <tr> <td>D.F. (tan δ)</td> <td>≤300% of the initial specified value</td> </tr> <tr> <td>Leakage current</td> <td>≤The initial specified value</td> </tr> </table>	Capacitance change	≤ ±30% of the initial value	D.F. (tan δ)	≤300% of the initial specified value	Leakage current	≤The initial specified value															
Capacitance change	≤ ±30% of the initial value																					
D.F. (tan δ)	≤300% of the initial specified value																					
Leakage current	≤The initial specified value																					
Vibration	The following specifications shall be satisfied when the capacitors are restored to 20°C after subjected to vibration test (vibration profile shown below) at room temperature (15 to 35°C). <table border="1"> <tr> <td>Capacitance change</td> <td>≤ ±5% of the initial value</td> </tr> <tr> <td>D.F. (tan δ)</td> <td>≤The initial specified value</td> </tr> <tr> <td>Leakage current</td> <td>≤The initial specified value</td> </tr> </table> <p>Vibration profile</p> <table border="1"> <tr> <td>Vibration frequency range</td> <td>10 to 2,000Hz</td> </tr> <tr> <td>Amplitude or Acceleration</td> <td>1.5mm peak to peak or 392m/s²(40G), whichever is the less severe</td> </tr> <tr> <td>Sweep rate</td> <td>10 to 2,000 to 10Hz 0.5 octave/minute</td> </tr> <tr> <td>Direction and period of motion</td> <td>2 hours in each of 3 mutually perpendicular directions (total of 6hours)</td> </tr> <tr> <td>Fixation</td> <td>Fix main body and Lead terminal using a fixture tool, please contact us for detail.</td> </tr> </table>	Capacitance change	≤ ±5% of the initial value	D.F. (tan δ)	≤The initial specified value	Leakage current	≤The initial specified value	Vibration frequency range	10 to 2,000Hz	Amplitude or Acceleration	1.5mm peak to peak or 392m/s ² (40G), whichever is the less severe	Sweep rate	10 to 2,000 to 10Hz 0.5 octave/minute	Direction and period of motion	2 hours in each of 3 mutually perpendicular directions (total of 6hours)	Fixation	Fix main body and Lead terminal using a fixture tool, please contact us for detail.					
Capacitance change	≤ ±5% of the initial value																					
D.F. (tan δ)	≤The initial specified value																					
Leakage current	≤The initial specified value																					
Vibration frequency range	10 to 2,000Hz																					
Amplitude or Acceleration	1.5mm peak to peak or 392m/s ² (40G), whichever is the less severe																					
Sweep rate	10 to 2,000 to 10Hz 0.5 octave/minute																					
Direction and period of motion	2 hours in each of 3 mutually perpendicular directions (total of 6hours)																					
Fixation	Fix main body and Lead terminal using a fixture tool, please contact us for detail.																					

◆DIMENSIONS [mm]

- Terminal Code : E

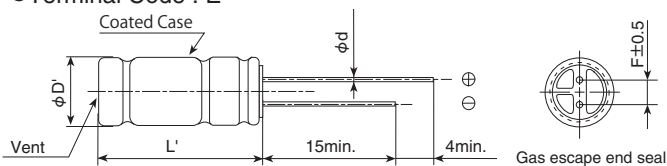

φD	18
φd	0.8
F	7.5
φD'	φD+0.5max.
L'	L+1.5max.

* Please contact us about lead formings and mounting methods.



GVA Series

◆PART NUMBERING SYSTEM

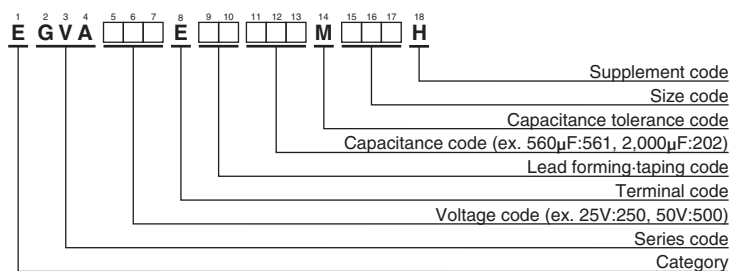

Please refer to "Product code guide (radial lead type)"

◆STANDARD RATINGS

WV (V _{dc})	Cap (μF)	Case size φD×L(mm)	ESR (Ω max./100kHz)		Rated ripple current (mArms/125°C, 100kHz)	Part No.
			20°C	-40°C		
25	3,900	18×30	0.023	0.11	3,330	EGVA250E□□392MM30H
	5,100	18×35.5	0.019	0.086	3,750	EGVA250E□□512MMP1H
35	2,700	18×30	0.023	0.11	3,330	EGVA350E□□272MM30H
	3,600	18×35.5	0.019	0.086	3,750	EGVA350E□□362MMP1H
50	1,600	18×30	0.027	0.14	3,000	EGVA500E□□162MM30H
	2,000	18×35.5	0.022	0.10	3,450	EGVA500E□□202MMP1H
63	1,200	18×30	0.045	0.34	2,530	EGVA630E□□122MM30H
	1,500	18×35.5	0.036	0.26	2,870	EGVA630E□□152MMP1H
80	750	18×30	0.045	0.34	2,530	EGVA800E□□751MM30H
	910	18×35.5	0.036	0.26	2,870	EGVA800E□□911MMP1H
100	430	18×30	0.055	0.41	2,290	EGVA101E□□431MM30H
	560	18×35.5	0.044	0.32	2,620	EGVA101E□□561MMP1H

□□ : Enter the appropriate lead forming or taping code.

◆RATED RIPPLE CURRENT MULTIPLIERS

●Frequency Multipliers

Capacitance(μF)	Frequency(Hz)			
	120	1k	10k	100k
430 to 560	0.50	0.85	0.94	1.00
750 to 2,000	0.60	0.87	0.95	1.00
2,700 to 3,900	0.75	0.90	0.95	1.00
5,100	0.85	0.95	0.98	1.00

The endurance of capacitors is reduced with internal heating produced by ripple current at the rate of halving the lifetime with every 5°C rise. When long life performance is required in actual use, the rms ripple current has to be reduced.

Please contact us for lifetime estimation.

Return Group Chart



MINIATURE ALUMINUM ELECTROLYTIC CAPACITORS

High ripple, 125°C

GXF Series New!

- Downsizing and high-ripple current version of GXE series
- For automobile modules and networking equipment and other high temperature applications
- Endurance with ripple current : 3,000 hours at 125
- Solvent resistant type except 160 to 400Vdc
- RoHS Compliant
- AEC-Q200 compliant : Please contact Chemi-Con for more details, test data, information.

GXE P215
↓
Downsized Higher ripple current
→ GXF

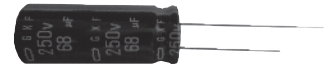

◆ SPECIFICATIONS

Items	Characteristics									
Category	-40 to +125°C									
Temperature Range										
Rated Voltage Range	25 to 400V _{dc}									
Capacitance Tolerance	±20%(M) (20°C, 120Hz)									
Leakage Current	25 to 100V _{dc}				160 to 400V _{dc}					
	I=0.03CV or 4 μA, whichever is greater.				CV ≤ 1,000		I=0.1CV+40			
					CV > 1,000		I=0.04CV+100			
Where, I : Max. leakage current (μA), C : Nominal capacitance (μF), V : Rated voltage (V) (at 20°C after 1 minute)										
Dissipation Factor (tan δ)	Rated voltage (V _{dc})	25V	35V	50V	63V	80V	100V	160 to 250V	350 to 400V	
	tan δ (Max.)	0.14	0.12	0.10	0.10	0.08	0.08	0.15	0.20	
	When nominal capacitance exceeds 1,000 μF, add 0.02 to the value above for each 1,000 μF increase. (at 20°C, 120Hz)									
Low Temperature Characteristics (Max. Impedance Ratio)	Rated voltage (V _{dc})	25V	35V	50V	63V	80V	100V	160 to 250V	350 to 400V	
	Z(-25°C)/Z(+20°C)	2	2	2	2	2	2	3	6	
	Z(-40°C)/Z(+20°C)	4	4	4	4	4	4	6	12	
(at 120Hz)										
Endurance	The following specifications shall be satisfied when the capacitors are restored to 20°C after subjected to DC voltage with the rated ripple current is applied (the peak voltage shall not exceed the rated voltage) for the 3,000 hours at 125°C.									
	Rated Voltage	25 to 100V _{dc}					160 to 400V _{dc}			
	Capacitance change	≤ ±30% of the initial value					≤ ±20% of the initial value			
	D.F. (tan δ)	≤ 300% of the initial specified value					≤ 200% of the initial specified value			
	Leakage current	≤ The initial specified value					≤ The initial specified value			
Shelf Life	The following specifications shall be satisfied when the capacitors are restored to 20°C after exposing them for 1,000 hours (500hours for 160 to 400V _{dc}) at 125°C without voltage applied. Before the measurement, the capacitor shall be preconditioned by applying voltage according to Item 4.1 of JIS C 5101-4.									
	Rated Voltage	25 to 100V _{dc}					160 to 400V _{dc}			
	Capacitance change	≤ ±30% of the initial value					≤ ±20% of the initial value			
	D.F. (tan δ)	≤ 300% of the initial specified value					≤ 200% of the initial specified value			
	Leakage current	≤ The initial specified value					≤ 500% of the initial specified value			

◆ DIMENSIONS [mm]

- Terminal Code : E

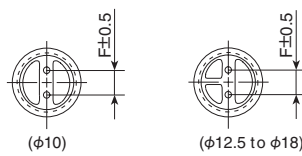
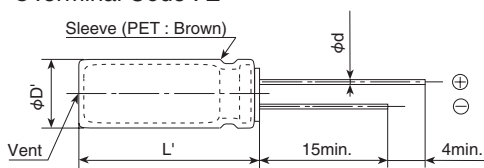

Gas escape end seal

	10	12.5	14.5	16	18
ΦD	10	12.5	14.5	16	18
Φd	0.6	0.6	0.8	0.8	0.8
F	5.0	5.0	7.5	7.5	7.5
ΦD'	ΦD+0.5max.				
L'	L+1.5max.				

◆ PART NUMBERING SYSTEM

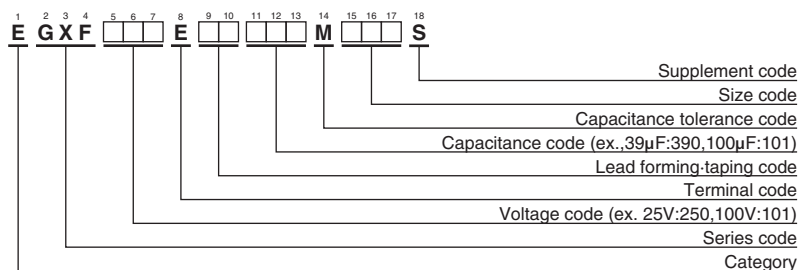

Please refer to "Product code guide (radial lead type)"

Return Group Chart



MINIATURE ALUMINUM ELECTROLYTIC CAPACITORS

High ripple, 125°C



◆STANDARD RATINGS

VV (V _{dc})	Cap (μF)	Case size φDxL (mm)	ESR (Ωmax./100kHz)		Rated ripple current (mA rms, 125°C, 100kHz)	Part No.	VV (V _{dc})	Cap (μF)	Case size φDxL (mm)	ESR (Ωmax./100kHz)		Rated ripple current (mA rms, 125°C, 100kHz)	Part No.
			20°C	-40°C						20°C	-40°C		
			Detailed table content follows, capturing the structure from the image										

Product specifications in this catalog are subject to change without notice. Request our product specifications before purchase and/or use. Please use our products based on the information contained in this catalog and product specifications.

Return Group Chart



MINIATURE ALUMINUM ELECTROLYTIC CAPACITORS

High ripple, 125°C



◆STANDARD RATINGS

□ is not solvent resistant.

VV (V _{dc})	Cap (μF)	Case size φDxL(mm)	ESR (Ωmax./100kHz)		Rated ripple current (mA _{rms} /125°C, 100kHz)	Part No.	VV (V _{dc})	Cap (μF)	Case size φDxL(mm)	ESR (Ωmax./100kHz)		Rated ripple current (mA _{rms} /125°C, 100kHz)	Part No.
			20°C	-40°C						20°C	-40°C		
100	330	16 × 25	0.057	0.39	2,190	EGXF101E□□331ML25S	250	39	10 × 30	—	—	1,410	EGXF251E□□390MJ30S
	330	18 × 20	0.069	0.39	1,690	EGXF101E□□331MM20S		47	10 × 35	—	—	1,600	EGXF251E□□470MJ35S
	360	14.5 × 30	0.050	0.40	2,620	EGXF101E□□361MU30S		51	12.5 × 25	—	—	1,510	EGXF251E□□510MK25S
	390	12.5 × 40	0.044	0.33	2,970	EGXF101E□□391MK40S		51	14.5 × 20	—	—	1,340	EGXF251E□□510MU20S
	390	14.5 × 35	0.044	0.33	2,850	EGXF101E□□391MU35S		56	10 × 40	—	—	1,790	EGXF251E□□560MJ40S
	390	16 × 30	0.044	0.33	2,770	EGXF101E□□391ML30S		62	16 × 20	—	—	1,500	EGXF251E□□620ML20S
	430	18 × 25	0.054	0.32	2,310	EGXF101E□□431MM25S		68	12.5 × 30	—	—	1,770	EGXF251E□□680MK30S
	510	14.5 × 40	0.038	0.26	3,230	EGXF101E□□511MU40S		68	14.5 × 25	—	—	1,610	EGXF251E□□680MU25S
	510	16 × 35	0.037	0.26	3,010	EGXF101E□□511ML35S		82	12.5 × 35	—	—	1,970	EGXF251E□□820MK35S
	560	18 × 30	0.043	0.26	2,830	EGXF101E□□561MM30S		82	18 × 20	—	—	1,730	EGXF251E□□820MM20S
	620	16 × 40	0.032	0.21	3,320	EGXF101E□□621ML40S		91	14.5 × 30	—	—	1,880	EGXF251E□□910MU30S
	680	18 × 35	0.034	0.19	3,210	EGXF101E□□681MM35S		91	16 × 25	—	—	1,850	EGXF251E□□910ML25S
820	18 × 40	0.029	0.16	3,410	EGXF101E□□821MM40S	100	12.5 × 40	—	—	2,150	EGXF251E□□101MK40S		
160	51	10 × 20	—	—	900	EGXF161E□□510MJ20S	100	14.5 × 35	—	—	2,030	EGXF251E□□101MU35S	
	62	10 × 25	—	—	1,200	EGXF161E□□620MJ25S	120	18 × 25	—	—	2,050	EGXF251E□□121MM25S	
	75	12.5 × 20	—	—	1,220	EGXF161E□□750MK20S	130	14.5 × 40	—	—	2,250	EGXF251E□□131MU40S	
	82	10 × 30	—	—	1,410	EGXF161E□□820MJ30S	16	10 × 20	—	—	460	EGXF351E□□160MJ20S	
	100	10 × 35	—	—	1,600	EGXF161E□□101MJ35S	20	10 × 25	—	—	610	EGXF351E□□200MJ25S	
	100	14.5 × 20	—	—	1,340	EGXF161E□□101MU20S	24	12.5 × 20	—	—	680	EGXF351E□□240MK20S	
	110	12.5 × 25	—	—	1,510	EGXF161E□□111MK25S	27	10 × 30	—	—	720	EGXF351E□□270MJ30S	
	120	10 × 40	—	—	1,790	EGXF161E□□121MJ40S	33	10 × 35	—	—	820	EGXF351E□□330MJ35S	
	130	16 × 20	—	—	1,500	EGXF161E□□131ML20S	33	14.5 × 20	—	—	870	EGXF351E□□330MU20S	
	150	12.5 × 30	—	—	1,770	EGXF161E□□151MK30S	36	10 × 40	—	—	940	EGXF351E□□360MJ40S	
	150	14.5 × 25	—	—	1,610	EGXF161E□□151MU25S	36	12.5 × 25	—	—	980	EGXF351E□□360MK25S	
	180	12.5 × 35	—	—	1,970	EGXF161E□□181MK35S	43	16 × 20	—	—	970	EGXF351E□□430ML20S	
	180	14.5 × 30	—	—	1,880	EGXF161E□□181MU30S	47	12.5 × 30	—	—	1,210	EGXF351E□□470MK30S	
	180	18 × 20	—	—	1,730	EGXF161E□□181MM20S	47	14.5 × 25	—	—	1,210	EGXF351E□□470MU25S	
	200	12.5 × 40	—	—	2,150	EGXF161E□□201MK40S	56	12.5 × 35	—	—	1,330	EGXF351E□□560MK35S	
	200	16 × 25	—	—	1,850	EGXF161E□□201ML25S	56	16 × 25	—	—	1,130	EGXF351E□□560ML25S	
	220	14.5 × 35	—	—	2,030	EGXF161E□□221MU35S	56	18 × 20	—	—	1,060	EGXF351E□□560MM20S	
240	18 × 25	—	—	2,050	EGXF161E□□241MM25S	62	14.5 × 30	—	—	1,410	EGXF351E□□620MU30S		
270	14.5 × 40	—	—	2,250	EGXF161E□□271MU40S	68	12.5 × 40	—	—	1,450	EGXF351E□□680MK40S		
200	36	10 × 20	—	—	900	EGXF201E□□360MJ20S	68	14.5 × 35	—	—	1,590	EGXF351E□□680MU35S	
	43	10 × 25	—	—	1,200	EGXF201E□□430MJ25S	75	18 × 25	—	—	1,200	EGXF351E□□750MM25S	
	56	12.5 × 20	—	—	1,220	EGXF201E□□560MK20S	91	14.5 × 40	—	—	1,820	EGXF351E□□910MU40S	
	62	10 × 30	—	—	1,410	EGXF201E□□620MJ30S	12	10 × 20	—	—	460	EGXF401E□□120MJ20S	
	75	10 × 35	—	—	1,600	EGXF201E□□750MJ35S	16	10 × 25	—	—	610	EGXF401E□□160MJ25S	
	75	14.5 × 20	—	—	1,340	EGXF201E□□750MU20S	20	10 × 30	—	—	720	EGXF401E□□200MJ30S	
	82	10 × 40	—	—	1,790	EGXF201E□□820MJ40S	20	12.5 × 20	—	—	680	EGXF401E□□200MK20S	
	82	12.5 × 25	—	—	1,510	EGXF201E□□820MK25S	24	10 × 35	—	—	820	EGXF401E□□240MJ35S	
	100	12.5 × 30	—	—	1,770	EGXF201E□□101MK30S	24	14.5 × 20	—	—	870	EGXF401E□□240MU20S	
	100	16 × 20	—	—	1,500	EGXF201E□□101ML20S	27	12.5 × 25	—	—	980	EGXF401E□□270MK25S	
	110	14.5 × 25	—	—	1,610	EGXF201E□□111MU25S	30	10 × 40	—	—	940	EGXF401E□□300MJ40S	
	130	12.5 × 35	—	—	1,970	EGXF201E□□131MK35S	33	16 × 20	—	—	970	EGXF401E□□330ML20S	
	130	14.5 × 30	—	—	1,880	EGXF201E□□131MU30S	36	12.5 × 30	—	—	1,210	EGXF401E□□360MK30S	
	130	18 × 20	—	—	1,730	EGXF201E□□131MM20S	36	14.5 × 25	—	—	1,210	EGXF401E□□360MU25S	
	150	12.5 × 40	—	—	2,150	EGXF201E□□151MK40S	43	12.5 × 35	—	—	1,330	EGXF401E□□430MK35S	
	150	16 × 25	—	—	1,850	EGXF201E□□151ML25S	43	18 × 20	—	—	1,060	EGXF401E□□430MM20S	
160	14.5 × 35	—	—	2,030	EGXF201E□□161MU35S	47	14.5 × 30	—	—	1,410	EGXF401E□□470MU30S		
180	18 × 25	—	—	2,050	EGXF201E□□181MM25S	47	16 × 25	—	—	1,130	EGXF401E□□470ML25S		
200	14.5 × 40	—	—	2,250	EGXF201E□□201MU40S	51	12.5 × 40	—	—	1,450	EGXF401E□□510MK40S		
250	24	10 × 20	—	—	900	EGXF251E□□240MJ20S	56	14.5 × 35	—	—	1,590	EGXF401E□□560MU35S	
	30	10 × 25	—	—	1,200	EGXF251E□□300MJ25S	62	18 × 25	—	—	1,200	EGXF401E□□620MM25S	
	36	12.5 × 20	—	—	1,220	EGXF251E□□360MK20S	68	14.5 × 40	—	—	1,820	EGXF401E□□680MU40S	

□ : Enter the appropriate lead forming or taping code.

◆RATED RIPPLE CURRENT MULTIPLIERS

● Frequency Multipliers
(25 to 100V_{dc})

Capacitance(μF)	Frequency(Hz)			
	120	1k	10k	100k
130 to 240	0.40	0.82	0.93	1.00
270 to 560	0.50	0.85	0.94	1.00
620 to 2,000	0.60	0.87	0.95	1.00
2,200 to 4,300	0.75	0.90	0.95	1.00
4,700 to 11,000	0.85	0.95	0.98	1.00

(160 to 400V_{dc})

Capacitance(μF)	Frequency(Hz)					
	50	120	300	1k	10k	100k
12 to 33	0.15	0.30	0.45	0.65	0.95	1.00
36 to 270	0.25	0.35	0.50	0.70	0.96	1.00

Please contact us for lifetime estimation.

Return Group Chart



MINIATURE ALUMINUM ELECTROLYTIC CAPACITORS

Long Life, Downsized, 125°C

GXE Series

- For automobile modules and other high temperature applications
- Downsize, long life, low impedance and better low temperature characteristics
- Endurance with ripple current : 2,000 to 5,000 hours at 125°C
- Solvent resistant type except 63 to 450V (see PRECAUTIONS AND GUIDELINES)
- RoHS Compliant
- AEC-Q200 compliant : Please contact Chemi-Con for more details, test data, information.



◆ SPECIFICATIONS

Items	Characteristics										
Category	-40 to +125°C (10 to 250V _{dc}) -25 to +125°C (350 to 450V _{dc})										
Temperature Range											
Rated Voltage Range	10 to 450V _{dc}										
Capacitance Tolerance	±20% (M) (at 20°C, 120Hz)										
Leakage Current	10 to 100V _{dc}					160 to 450V _{dc}					
	I=0.03CV or 4μA, whichever is greater.					CV ≤ 1,000		I=0.1CV+40			
						CV > 1,000		I=0.04CV+100			
Where, I : Max. leakage current (μA), C : Nominal capacitance (μF), V : Rated voltage (V) (at 20°C, 1 minute)											
Dissipation Factor (tan δ)	Rated voltage (V _{dc})	10V	16V	25V	35V	50V	63V	80V	100V	160 to 250V	350 to 450V
	tan δ (Max.)	0.20	0.16	0.14	0.12	0.10	0.10	0.08	0.08	0.20	0.24
	When nominal capacitance exceeds 1,000μF, add 0.02 to the value above for each 1,000μF increase. (at 20°C, 120Hz)										
Low Temperature Characteristics (Max. Impedance Ratio)	Rated voltage (V _{dc})	10V	16V	25V	35V	50V	63V	80V	100V	160 to 250V	350 to 450V
	Z(-25°C)/Z(+20°C)	3	2	2	2	2	2	2	2	3	6
	Z(-40°C)/Z(+20°C)	6	4	4	4	4	4	4	4	6	—
(at 120Hz)											
Endurance	The following specifications shall be satisfied when the capacitors are restored to 20°C after subjected to DC voltage with the rated ripple current is applied (the peak voltage shall not exceed the rated voltage) for the specified time at 125°C.										
		10 to 100V _{dc}					160 to 450V _{dc}				
	Time	φ8 : 2,000hours φ10 : 3,000hours φ12.5 & φ16 : 5,000hours					2,000hours				
	Capacitance change	≤ ±30% of the initial value					≤ ±20% of the initial value				
	D.F. (tan δ)	≤300% of the initial specified value					≤200% of the initial specified value				
Leakage current	≤The initial specified value					≤The initial specified value					
Shelf Life	The following specifications shall be satisfied when the capacitors are restored to 20°C after exposing them for 1,000 hours (500 hours for 350 to 450V _{dc}) at 125°C without voltage applied. Before the measurement, the capacitor shall be preconditioned by applying voltage according to Item 4.1 of JIS C 5101-4.										
		10 to 100V _{dc}					160 to 450V _{dc}				
	Capacitance change	≤ ±30% of the initial value					≤ ±20% of the initial value				
	D.F. (tan δ)	≤300% of the initial specified value					≤200% of the initial specified value				
	Leakage current	≤The initial specified value					≤500% of the initial specified value				

◆ DIMENSIONS [mm]

● Terminal Code : E

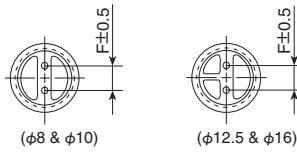
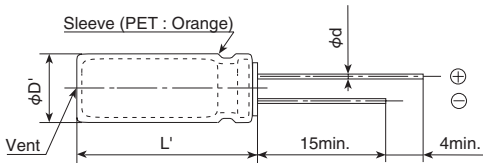

φD	8	10	12.5	16
φd	0.6	0.6	0.6	0.8
F	3.5	5.0	5.0	7.5
φD'	φD+0.5max.			
L'	L+2.0max.			

◆ PART NUMBERING SYSTEM

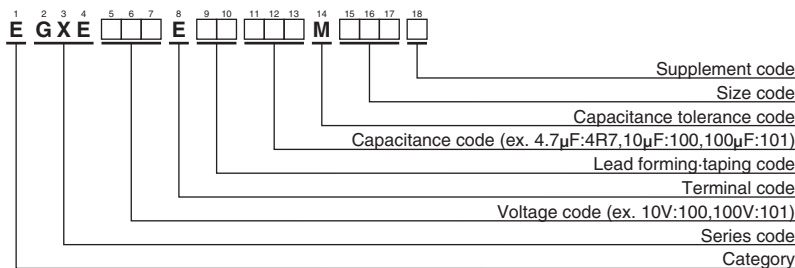

Please refer to "Product code guide (radial lead type)"

Return Group Chart



MINIATURE ALUMINUM ELECTROLYTIC CAPACITORS

Long Life, Downsized, 125°C

GXE Series

◆STANDARD RATINGS

□ is not solvent resistant.

WV (V _{dc})	Cap (μF)	Case size φD×L(mm)	Impedance (Ω max./20°C, 100kHz)	Rated ripple current (mA rms/125°C, Note1)	Part No.	WV (V _{dc})	Cap (μF)	Case size φD×L(mm)	Impedance (Ω max./20°C, 100kHz)	Rated ripple current (mA rms/125°C, Note1)	Part No.
10	220	8×12	0.32	340	EGXE100E□□221MH12D	80	47	10×12.5	0.80	480	EGXE800E□□470MJC5S
	330	10×12.5	0.15	620	EGXE100E□□331MJC5S		100	10×20	0.39	790	EGXE800E□□101MJ20S
	470	10×12.5	0.15	620	EGXE100E□□471MJC5S		220	12.5×25	0.18	1,240	EGXE800E□□221MK25S
	1,000	10×20	0.075	950	EGXE100E□□102MJ20S		330	12.5×30	0.16	1,390	EGXE800E□□331MK30S
	2,200	12.5×25	0.040	1,350	EGXE100E□□222MK25S		470	16×25	0.11	1,500	EGXE800E□□471ML25S
	3,300	16×25	0.031	1,620	EGXE100E□□332ML25S		100	4.7	8×12	2.0	130
4,700	16×31.5	0.025	1,860	EGXE100E□□472MLN3S	10	8×12		1.5	150	EGXE101E□□100MH12D	
16	100	8×12	0.32	340	EGXE160E□□101MH12D	22		10×12.5	0.80	480	EGXE101E□□220MJC5S
	220	10×12.5	0.15	620	EGXE160E□□221MJC5S	33		10×12.5	0.80	480	EGXE101E□□330MJC5S
	330	10×12.5	0.15	620	EGXE160E□□331MJC5S	47		10×16	0.55	630	EGXE101E□□470MJ16S
	470	10×16	0.094	790	EGXE160E□□471MJ16S	100		12.5×20	0.25	990	EGXE101E□□100MK20S
	1,000	12.5×20	0.058	1,080	EGXE160E□□102MK20S	220	16×25	0.11	1,500	EGXE101E□□221ML25S	
	2,200	16×25	0.031	1,620	EGXE160E□□222ML25S	330	16×31.5	0.079	1,790	EGXE101E□□331MLN3S	
25	3,300	16×31.5	0.025	1,860	EGXE160E□□332MLN3S	160	22	10×20	—	115	EGXE161E□□220MJ20S
	100	8×12	0.32	340	EGXE250E□□101MH12D		33	10×25	—	154	EGXE161E□□330MH12D
	220	10×12.5	0.15	620	EGXE250E□□221MJC5S		47	12.5×20	—	187	EGXE161E□□470MK20S
	330	10×16	0.094	790	EGXE250E□□331MJ16S		68	12.5×25	—	245	EGXE161E□□680MK25S
	470	10×20	0.075	950	EGXE250E□□471MJ20S		100	16×25	—	329	EGXE161E□□101ML25S
	1,000	12.5×25	0.040	1,350	EGXE250E□□102MK25S		150	16×31.5	—	434	EGXE161E□□151MLN3S
35	2,200	16×31.5	0.025	1,860	EGXE250E□□222MLN3S	200	10	10×20	—	78	EGXE201E□□100MJ20S
	100	8×12	0.32	340	EGXE350E□□101MH12D		22	10×25	—	126	EGXE201E□□220MJ25S
	100	10×12.5	0.15	620	EGXE350E□□101MJC5S		33	12.5×20	—	157	EGXE201E□□330MK20S
	220	10×16	0.094	790	EGXE350E□□221MJ16S		47	12.5×25	—	204	EGXE201E□□470MK25S
	330	10×20	0.075	950	EGXE350E□□331MJ20S		68	16×20	—	250	EGXE201E□□680ML20S
	470	12.5×20	0.058	1,080	EGXE350E□□471MK20S		100	16×25	—	329	EGXE201E□□101ML25S
50	1,000	16×25	0.031	1,620	EGXE350E□□102ML25S	250	10	10×20	—	78	EGXE251E□□100MJ20S
	10	8×12	0.75	180	EGXE500E□□100MH12D		22	12.5×20	—	128	EGXE251E□□220MK20S
	22	8×12	0.50	250	EGXE500E□□220MH12D		33	12.5×25	—	171	EGXE251E□□330MK25S
	33	8×12	0.50	280	EGXE500E□□330MH12D		47	16×25	—	225	EGXE251E□□470ML25S
	47	8×12	0.50	280	EGXE500E□□470MH12D		68	16×31.5	—	292	EGXE251E□□680MLN3S
	100	10×12.5	0.20	520	EGXE500E□□101MJC5S		350	4.7	10×20	—	53
220	10×20	0.098	880	EGXE500E□□221MJ20S	10	10×25		—	85	EGXE351E□□100MJ25S	
330	12.5×20	0.081	990	EGXE500E□□331MK20S	22	12.5×25		—	139	EGXE351E□□220MK25S	
470	12.5×25	0.059	1,150	EGXE500E□□471MK25S	33	16×25		—	189	EGXE351E□□330ML25S	
1,000	16×31.5	0.032	1,590	EGXE500E□□102MLN3S	47	16×31.5		—	243	EGXE351E□□470MLN3S	
63	33	8×12	1.5	150	EGXE630E□□330MH12D	400		4.7	10×20	—	53
	47	10×12.5	0.59	530	EGXE630E□□470MJC5S		10	10×25	—	86	EGXE401E□□100MJ25S
	100	10×16	0.41	690	EGXE630E□□101MJ16S		22	12.5×30	—	142	EGXE401E□□220MK30S
	220	12.5×20	0.16	1,050	EGXE630E□□221MK20S		33	16×25	—	189	EGXE401E□□330ML25S
	330	12.5×25	0.12	1,290	EGXE630E□□331MK25S		47	16×31.5	—	243	EGXE401E□□470MLN3S
	470	12.5×30	0.097	1,460	EGXE630E□□471MK30S		450	4.7	10×25	—	58
1,000	16×31.5	0.059	1,850	EGXE630E□□102MLN3S	10	12.5×20		—	86	EGXE451E□□100MK20S	
22	8×12	1.5	150	EGXE800E□□220MH12D	22	16×25		—	154	EGXE451E□□220ML25S	
80	33	10×12.5	0.80	480	EGXE800E□□330MJC5S	33	16×31.5	—	203	EGXE451E□□330MLN3S	

□ □ : Enter the appropriate lead forming or taping code.

(Note1) Ripple current frequency
 10 to 100V = 100kHz
 160 to 450V = 120Hz

◆RATED RIPPLE CURRENT MULTIPLIERS

● Frequency Multipliers

(10 to 100V_{dc})

Capacitance(μF)	Frequency(Hz)	120	1k	10k	100k
4.7 to 100		0.40	0.75	0.90	1.00
220 to 470		0.50	0.85	0.94	1.00
1,000		0.60	0.87	0.95	1.00
2,200 to 3,300		0.75	0.90	0.95	1.00
4,700		0.85	0.95	0.98	1.00

(160 to 450V_{dc})

Capacitance(μF)	Frequency(Hz)	50	120	300	1k	10k	100k
4.7 to 33		0.75	1.00	1.25	1.50	1.75	1.80
47 to 150		0.80	1.00	1.15	1.30	1.40	1.50

The endurance of capacitors is reduced with internal heating produced by ripple current at the rate of halving the lifetime with every 5°C rise. When long life performance is required in actual use, the rms ripple current has to be reduced.

Return Group Chart



MINIATURE ALUMINUM ELECTROLYTIC CAPACITORS

Long life, 125°C

GXL Series

- Long-Life version of GXE series
- For automobile modules and other high temperature applications
- Endurance with ripple current : 5,000 hours at 125°C
- Solvent resistant type (see PRECAUTIONS AND GUIDELINES)
- RoHS Compliant
- AEC-Q200 compliant : Please contact Chemi-Con for more details, test data, information.

GXL

Longer life

GXE P215



◆SPECIFICATIONS

Items	Characteristics						
Category	-40 to +125°C						
Temperature Range	-40 to +125°C						
Rated Voltage Range	10 to 50V _{ac}						
Capacitance Tolerance	±20% (M) (at 20°C, 120Hz)						
Leakage Current	I=0.03CV or 4μA, whichever is greater. Where, I : Max. leakage current (μA), C : Nominal capacitance (μF), V : Rated voltage (V) (at 20°C, 1 minute)						
Dissipation Factor (tan δ)	Rated voltage (V _{ac})	10V	16V	25V	35V	50V	(at 20°C, 120Hz)
	tan δ (Max.)	0.20	0.16	0.14	0.12	0.10	
Low Temperature Characteristics (Max. Impedance Ratio)	Rated voltage (V _{ac})	10V	16V	25V	35V	50V	(at 120Hz)
	Z(-25°C)/Z(+20°C)	3	2	2	2	2	
	Z(-40°C)/Z(+20°C)	6	4	4	4	4	
Endurance	The following specifications shall be satisfied when the capacitors are restored to 20°C after subjected to DC voltage with the rated ripple current is applied (the peak voltage shall not exceed the rated voltage) for 5,000 hours at 125°C.						
	Capacitance change	≤ ±30% of the initial value					
	D.F. (tan δ)	≤300% of the initial specified value					
	Leakage current	≤The initial specified value					
Shelf Life	The following specifications shall be satisfied when the capacitors are restored to 20°C after exposing them for 1,000 hours at 125°C without voltage applied. Before the measurement, the capacitor shall be preconditioned by applying voltage according to Item 4.1 of JIS C 5101-4.						
	Capacitance change	≤ ±30% of the initial value					
	D.F. (tan δ)	≤300% of the initial specified value					
	Leakage current	≤The initial specified value					

◆DIMENSIONS [mm]

- Terminal Code : E

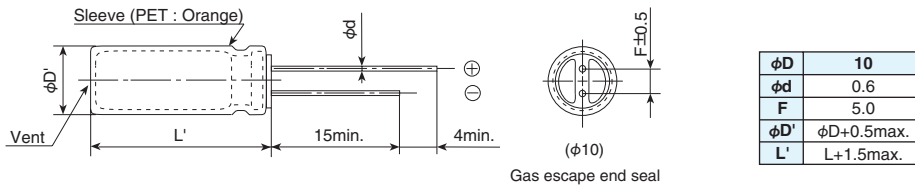

◆PART NUMBERING SYSTEM

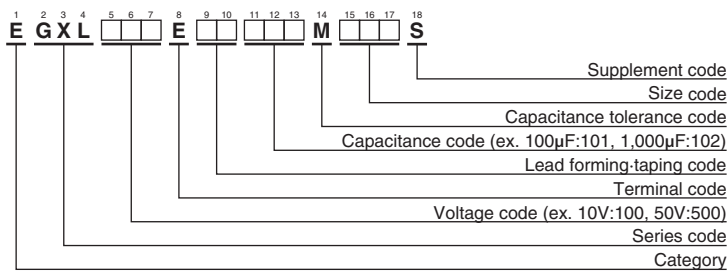

Please refer to "Product code guide (radial lead type)"



GXL Series

◆ STANDARD RATINGS

WV (V _{dc})	Cap (μF)	Case size φ D×L(mm)	Impedance (Ω max./20°C, 100kHz)	Rated ripple current (mA _{rms} /125°C, 100kHz)	Part No.
10	330	10×12.5	0.17	800	EGXL100E□□331MJC5S
	470	10×12.5	0.17	800	EGXL100E□□471MJC5S
	1,000	10×20	0.094	1,300	EGXL100E□□102MJ20S
16	220	10×12.5	0.17	800	EGXL160E□□221MJC5S
	330	10×12.5	0.17	800	EGXL160E□□331MJC5S
	470	10×16	0.12	1,050	EGXL160E□□471MJ16S
25	220	10×12.5	0.17	800	EGXL250E□□221MJC5S
	330	10×16	0.12	1,050	EGXL250E□□331MJ16S
	470	10×20	0.094	1,300	EGXL250E□□471MJ20S
35	100	10×12.5	0.17	800	EGXL350E□□101MJC5S
	220	10×16	0.12	1,050	EGXL350E□□221MJ16S
	330	10×20	0.094	1,300	EGXL350E□□331MJ20S
50	100	10×12.5	0.30	590	EGXL500E□□101MJC5S
	220	10×20	0.19	970	EGXL500E□□221MJ20S

□□ : Enter the appropriate lead forming or taping code.

◆ RATED RIPPLE CURRENT MULTIPLIERS

● Frequency Multipliers

Capacitance(μF)	Frequency(Hz)			
	120	1k	10k	100k
100	0.40	0.75	0.90	1.00
220 to 470	0.50	0.85	0.94	1.00
1,000	0.60	0.87	0.95	1.00

The endurance of capacitors is reduced with internal heating produced by ripple current at the rate of halving the lifetime with every 5°C rise. When long life performance is required in actual use, the rms ripple current has to be reduced.

Return Group Chart



MINIATURE ALUMINUM ELECTROLYTIC CAPACITORS

Long life, High ripple, 135°C

GPD Series

- Guaranteed short time at 150°C
- Downsized and high-ripple current version of GPA series
- For automobile modules and other high temperature applications
- Endurance with ripple current : 2,000 to 3,000 hours at 125°C to 135°C
- Solvent resistant type (see PRECAUTIONS AND GUIDELINES)
- RoHS Compliant
- AEC-Q200 compliant : Please contact Chemi-Con for more details, test data, information.

GPA P207 → Downsized Higher ripple current → **GPD**



◆ SPECIFICATIONS

Items	Characteristics							
Category	-40 to +135°C							
Temperature Range	-40 to +135°C							
Rated Voltage Range	25 to 100V _{dc}							
Capacitance Tolerance	±20% (M) (at 20°C, 120Hz)							
Leakage Current	I=0.03CV or 4μA, whichever is greater. Where, I : Max. leakage current (μA), C : Nominal capacitance (μF), V : Rated voltage (V) (at 20°C, 1 minute)							
Dissipation Factor (tan δ)	Rated voltage (V _{dc})	25V	35V	50V	63V	80V	100V	
	tan δ (Max.)	0.14	0.12	0.10	0.10	0.08	0.08	
	When nominal capacitance exceeds 1,000μF, add 0.02 to the value above for each 1,000μF increase. (at 20°C, 120Hz)							
Low Temperature Characteristics (Max. Impedance Ratio)	Rated voltage (V _{dc})	25V	35V	50V	63V	80V	100V	
	Z(-25°C)/Z(+20°C)	2	2	2	2	2	2	
	Z(-40°C)/Z(+20°C)	4	4	4	4	4	4	
Endurance 1	The following specifications shall be satisfied when the capacitors are restored to 20°C after subjected to DC voltage with the rated ripple current is applied (the peak voltage shall not exceed the rated voltage) for the specified period of time at 125°C or 135°C.							
	Time	125°C	3,000hours					
		135°C	25 to 50V _{dc} :		3,000hours			
			63 to 100V _{dc} :		2,000hours			
	Capacitance change	≤ ±30% of the initial value						
D.F. (tan δ)	≤300% of the initial specified value							
Leakage current	≤The initial specified value							
Endurance 2	The following specifications shall be satisfied when the capacitors are restored to 20°C after the test condition that the rated voltage is applied for 100 hours at 150°C and DC voltage with the rated ripple current is applied (the peak voltage shall not exceed the rated voltage) for the specified period of time at 125°C or 135°C.							
	Time	125°C	2,500hours					
		135°C	25 to 50V _{dc} :		2,500hours			
			63 to 100V _{dc} :		1,500hours			
	Capacitance change	≤ ±30% of the initial value						
D.F. (tan δ)	≤300% of the initial specified value							
Leakage current	≤The initial specified value							
Shelf Life	The following specifications shall be satisfied when the capacitors are restored to 20°C after exposing them for 1,000 hours at 125°C without voltage applied. Before the measurement, the capacitor shall be preconditioned by applying voltage according to Item 4.1 of JIS C 5101-4.							
	Capacitance change	≤ ±30% of the initial value						
	D.F. (tan δ)	≤300% of the initial specified value						
	Leakage current	≤The initial specified value						

◆ DIMENSIONS [mm]

- Terminal Code : E

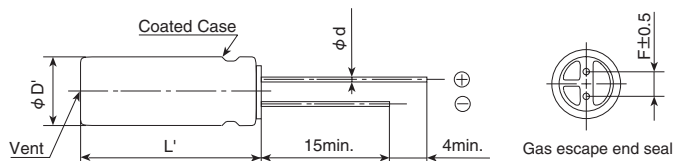

φD	12.5	14.5	16	18
φd	0.6	0.8	0.8	0.8
F	5.0	7.5	7.5	7.5
φD'	φD+0.5max.			
L'	L+1.5max.			

◆ PART NUMBERING SYSTEM

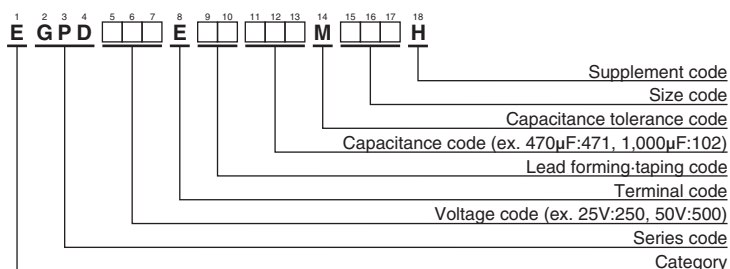

Please refer to "Product code guide (radial lead type)"

Return Group Chart



MINIATURE ALUMINUM ELECTROLYTIC CAPACITORS

Long life, High ripple, 135°C

GPDSeries

◆STANDARD RATINGS

VV (V _{dc})	Cap (μF)	Case size φD×L(mm)	ESR (Ω max./100kHz)		Rated ripple current (mA rms/100kHz)		Part No.
			20°C	-40°C	125°C	135°C	
25	2,000	12.5 × 20	0.042	0.48	2,760	1,690	EGPD250E□□202MK20H
	2,700	14.5 × 20	0.038	0.37	2,990	1,830	EGPD250E□□272MU20H
	3,000	12.5 × 25	0.033	0.30	3,480	2,010	EGPD250E□□302MK25H
	3,300	16 × 20	0.035	0.27	3,040	1,860	EGPD250E□□332ML20H
	3,600	12.5 × 30	0.028	0.24	4,490	2,900	EGPD250E□□362MK30H
	3,900	14.5 × 25	0.030	0.28	4,120	2,780	EGPD250E□□392MU25H
	4,300	18 × 20	0.034	0.22	3,250	1,870	EGPD250E□□432MM20H
	4,700	12.5 × 35	0.025	0.21	5,140	3,190	EGPD250E□□472MK35H
	4,700	16 × 25	0.028	0.22	4,260	2,870	EGPD250E□□472ML25H
	5,100	12.5 × 40	0.024	0.19	5,810	3,470	EGPD250E□□512MK40H
	5,100	14.5 × 30	0.025	0.24	4,880	3,150	EGPD250E□□512MU30H
	5,600	14.5 × 35	0.023	0.20	5,420	3,360	EGPD250E□□562MU35H
	5,600	16 × 30	0.023	0.18	5,480	3,400	EGPD250E□□562ML30H
	6,200	18 × 25	0.027	0.19	4,500	2,900	EGPD250E□□622MM25H
	6,800	14.5 × 40	0.022	0.16	6,240	3,730	EGPD250E□□682MU40H
	7,500	16 × 35	0.020	0.14	6,070	3,630	EGPD250E□□752ML35H
	7,500	18 × 30	0.022	0.16	5,600	3,470	EGPD250E□□752MM30H
	9,100	16 × 40	0.019	0.12	6,810	3,930	EGPD250E□□912ML40H
10,000	18 × 35	0.019	0.12	6,280	3,750	EGPD250E□□103MM35H	
12,000	18 × 40	0.018	0.10	7,070	4,080	EGPD250E□□123MM40H	
35	1,300	12.5 × 20	0.042	0.48	2,760	1,690	EGPD350E□□132MK20H
	1,600	14.5 × 20	0.038	0.37	2,990	1,830	EGPD350E□□162MU20H
	1,800	12.5 × 25	0.033	0.30	3,480	2,010	EGPD350E□□182MK25H
	2,000	16 × 20	0.035	0.27	3,040	1,860	EGPD350E□□202ML20H
	2,200	12.5 × 30	0.028	0.24	4,490	2,900	EGPD350E□□222MK30H
	2,400	14.5 × 25	0.030	0.28	4,120	2,780	EGPD350E□□242MU25H
	2,400	18 × 20	0.034	0.22	3,250	1,870	EGPD350E□□242MM20H
	2,700	12.5 × 35	0.025	0.21	5,140	3,190	EGPD350E□□272MK35H
	3,000	14.5 × 30	0.025	0.24	4,880	3,150	EGPD350E□□302MU30H
	3,000	16 × 25	0.028	0.22	4,260	2,870	EGPD350E□□302ML25H
	3,300	12.5 × 40	0.024	0.19	5,810	3,470	EGPD350E□□332MK40H
	3,300	14.5 × 35	0.023	0.20	5,420	3,360	EGPD350E□□332MU35H
	3,600	16 × 30	0.023	0.18	5,480	3,400	EGPD350E□□362ML30H
	3,900	18 × 25	0.027	0.19	4,500	2,900	EGPD350E□□392MM25H
	4,300	14.5 × 40	0.022	0.16	6,240	3,730	EGPD350E□□432MU40H
	4,300	16 × 35	0.020	0.14	6,070	3,630	EGPD350E□□432ML35H
	4,700	18 × 30	0.022	0.16	5,600	3,470	EGPD350E□□472MM30H
	5,600	16 × 40	0.019	0.12	6,810	3,930	EGPD350E□□562ML40H
6,200	18 × 35	0.019	0.12	6,280	3,750	EGPD350E□□622MM35H	
7,500	18 × 40	0.018	0.10	7,070	4,080	EGPD350E□□752MM40H	
50	620	12.5 × 20	0.073	0.88	2,400	1,470	EGPD500E□□621MK20H
	750	14.5 × 20	0.063	0.73	2,760	1,590	EGPD500E□□751MU20H
	820	12.5 × 25	0.058	0.67	3,350	2,260	EGPD500E□□821MK25H
	1,000	16 × 20	0.050	0.55	2,960	1,870	EGPD500E□□102ML20H
	1,100	12.5 × 30	0.048	0.52	4,220	2,520	EGPD500E□□112MK30H
	1,100	14.5 × 25	0.048	0.52	3,750	2,420	EGPD500E□□112MU25H
	1,300	12.5 × 35	0.042	0.44	4,810	2,780	EGPD500E□□132MK35H
	1,300	16 × 25	0.042	0.44	4,040	2,500	EGPD500E□□132ML25H
	1,300	18 × 20	0.042	0.44	3,130	2,110	EGPD500E□□132MM20H
	1,500	14.5 × 30	0.038	0.39	4,590	2,740	EGPD500E□□152MU30H
	1,600	12.5 × 40	0.037	0.36	5,240	3,020	EGPD500E□□162MK40H
	1,600	14.5 × 35	0.035	0.36	5,060	2,920	EGPD500E□□162MU35H
	1,600	16 × 30	0.035	0.36	5,130	2,960	EGPD500E□□162ML30H
	1,800	18 × 25	0.033	0.32	4,230	2,530	EGPD500E□□182MM25H
	2,200	14.5 × 40	0.029	0.27	5,630	3,250	EGPD500E□□222MU40H
	2,200	16 × 35	0.029	0.27	5,480	3,160	EGPD500E□□222ML35H
	2,400	18 × 30	0.028	0.25	5,240	3,020	EGPD500E□□242MM30H
	2,700	16 × 40	0.025	0.22	5,930	3,420	EGPD500E□□272ML40H
3,000	18 × 35	0.024	0.20	5,870	3,390	EGPD500E□□302MM35H	
3,600	18 × 40	0.023	0.16	6,420	3,700	EGPD500E□□362MM40H	
63	390	12.5 × 20	0.072	0.56	1,640	1,420	EGPD630E□□391MK20H
	560	12.5 × 25	0.052	0.39	2,520	2,050	EGPD630E□□561MK25H
	560	14.5 × 20	0.061	0.40	1,790	1,550	EGPD630E□□561MU20H
	680	16 × 20	0.053	0.34	2,140	1,910	EGPD630E□□681ML20H
	750	12.5 × 30	0.042	0.30	3,110	2,630	EGPD630E□□751MK30H
	750	14.5 × 25	0.047	0.30	2,650	2,160	EGPD630E□□751MU25H
	910	12.5 × 35	0.035	0.25	3,760	2,970	EGPD630E□□911MK35H
910	18 × 20	0.044	0.26	2,350	2,100	EGPD630E□□911MM20H	

□□ : Enter the appropriate lead forming or taping code.

Return Group Chart



MINIATURE ALUMINUM ELECTROLYTIC CAPACITORS

Long life, High ripple, 135°C

GPD Series

◆STANDARD RATINGS

VV (V _{dc})	Cap (μF)	Case size φD×L(mm)	ESR (Ω max./100kHz)		Rated ripple current (mA rms/100kHz)		Part No.
			20°C	-40°C	125°C	135°C	
63	1,000	14.5 × 30	0.037	0.23	3,360	2,840	EGPD630E□□102MU30H
	1,000	16 × 25	0.038	0.23	2,940	2,680	EGPD630E□□102ML25H
	1,100	12.5 × 40	0.031	0.22	4,610	3,260	EGPD630E□□112MK40H
	1,200	14.5 × 35	0.033	0.20	3,860	3,050	EGPD630E□□122MU35H
	1,200	16 × 30	0.034	0.20	3,860	3,050	EGPD630E□□122ML30H
	1,300	18 × 25	0.033	0.19	3,080	2,810	EGPD630E□□132MM25H
	1,500	14.5 × 40	0.028	0.16	4,930	3,490	EGPD630E□□152MU40H
	1,600	16 × 35	0.027	0.15	4,590	3,420	EGPD630E□□162ML35H
	1,600	18 × 30	0.028	0.15	4,080	3,220	EGPD630E□□162MM30H
	1,800	16 × 40	0.025	0.14	5,190	3,670	EGPD630E□□182ML40H
80	270	12.5 × 20	0.072	0.56	1,640	1,420	EGPD800E□□271MK20H
	360	14.5 × 20	0.061	0.40	1,790	1,550	EGPD800E□□361MU20H
	390	12.5 × 25	0.052	0.39	2,520	2,050	EGPD800E□□391MK25H
	470	16 × 20	0.053	0.34	2,140	1,910	EGPD800E□□471ML20H
	510	12.5 × 30	0.042	0.30	3,110	2,630	EGPD800E□□511MK30H
	510	14.5 × 25	0.047	0.30	2,650	2,160	EGPD800E□□511MU25H
	620	12.5 × 35	0.035	0.25	3,760	2,970	EGPD800E□□621MK35H
	620	18 × 20	0.044	0.26	2,350	2,100	EGPD800E□□621MM20H
	680	14.5 × 30	0.037	0.23	3,360	2,840	EGPD800E□□681MU30H
	680	16 × 25	0.038	0.23	2,940	2,680	EGPD800E□□681ML25H
	750	12.5 × 40	0.031	0.22	4,610	3,260	EGPD800E□□751MK40H
	750	14.5 × 35	0.033	0.20	3,860	3,050	EGPD800E□□751MU35H
	750	16 × 30	0.034	0.20	3,860	3,050	EGPD800E□□751ML30H
	820	18 × 25	0.033	0.19	3,080	2,810	EGPD800E□□821MM25H
	1,000	14.5 × 40	0.028	0.16	4,930	3,490	EGPD800E□□102MU40H
	1,000	16 × 35	0.027	0.15	4,590	3,420	EGPD800E□□102ML35H
	1,100	18 × 30	0.028	0.15	4,080	3,220	EGPD800E□□112MM30H
	1,300	16 × 40	0.025	0.14	5,190	3,670	EGPD800E□□132ML40H
	1,300	18 × 35	0.022	0.12	5,220	3,690	EGPD800E□□132MM35H
	1,600	18 × 40	0.021	0.11	5,660	3,820	EGPD800E□□162MM40H
100	160	12.5 × 20	0.090	0.75	1,580	1,410	EGPD101E□□161MK20H
	200	14.5 × 20	0.083	0.61	1,660	1,480	EGPD101E□□201MU20H
	220	12.5 × 25	0.068	0.55	2,140	1,960	EGPD101E□□221MK25H
	270	16 × 20	0.067	0.47	2,050	1,670	EGPD101E□□271ML20H
	300	12.5 × 30	0.052	0.41	2,950	2,330	EGPD101E□□301MK30H
	300	14.5 × 25	0.058	0.42	2,300	2,100	EGPD101E□□301MU25H
	360	12.5 × 35	0.045	0.35	3,530	2,630	EGPD101E□□361MK35H
	360	18 × 20	0.061	0.35	2,270	1,860	EGPD101E□□361MM20H
	390	14.5 × 30	0.047	0.33	3,120	2,460	EGPD101E□□391MU30H
	390	16 × 25	0.048	0.33	2,790	2,360	EGPD101E□□391ML25H
	430	12.5 × 40	0.038	0.29	4,140	2,920	EGPD101E□□431MK40H
	430	14.5 × 35	0.043	0.30	3,510	2,620	EGPD101E□□431MU35H
	470	16 × 30	0.041	0.27	3,440	2,720	EGPD101E□□471ML30H
	510	18 × 25	0.045	0.25	2,920	2,470	EGPD101E□□511MM25H
	560	14.5 × 40	0.034	0.23	4,330	3,060	EGPD101E□□561MU40H
	560	16 × 35	0.036	0.23	4,190	2,960	EGPD101E□□561ML35H
	620	18 × 30	0.037	0.20	3,920	2,920	EGPD101E□□621MM30H
	750	16 × 40	0.028	0.18	5,020	3,380	EGPD101E□□751ML40H
	820	18 × 35	0.030	0.16	4,710	3,330	EGPD101E□□821MM35H
	910	18 × 40	0.026	0.14	5,280	3,560	EGPD101E□□911MM40H

□□ : Enter the appropriate lead forming or taping code.

◆RATED RIPPLE CURRENT MULTIPLIERS

● Frequency Multipliers

Capacitance(μF)	Frequency(Hz)			
	120	1k	10k	100k
160 to 200	0.40	0.75	0.90	1.00
220 to 620	0.50	0.85	0.94	1.00
680 to 2,000	0.60	0.87	0.95	1.00
2,200 to 4,300	0.75	0.90	0.95	1.00
4,700 to 12,000	0.85	0.95	0.98	1.00

Please contact us for lifetime estimation.

Return Group Chart



MINIATURE ALUMINUM ELECTROLYTIC CAPACITORS

Vibration resistant structure, 135°C

GVD Series

- Structure of higher vibration resistance by GPD series (acceleration 392m/s², 40G)
- Guaranteed short time at 150°C
- Designed for electric power steering and ECU (include engine control, direct fuel injection) etc.
- Rated voltage range : 25 to 100V, Capacitance range : 510 to 8,200μF
- Solvent resistant type
- RoHS Compliant
- AEC-Q200 compliant : Please contact Chemi-Con for more details, test data, information.

GPD
P219

Vibration resistance

GVD



SPECIFICATIONS

Items	Characteristics	
Category		
Temperature Range	-40 to +135°C	
Rated Voltage Range	25 to 100V _{dc}	
Capacitance Tolerance	±20% (M) (at 20°C, 120Hz)	
Leakage Current	I=0.03CV or 4μA, whichever is greater. Where, I : Max. leakage current (μA), C : Nominal capacitance (μF), V : Rated voltage (V) (at 20°C, 1 minute)	
Dissipation Factor (tan δ)	Rated voltage (V _{dc})	
	25V 35V 50V 63V 80V 100V	
	tan δ (Max.)	
	0.14 0.12 0.10 0.10 0.08 0.08	
	When nominal capacitance exceeds 1,000μF, add 0.02 to the value above for each 1,000μF increase. (at 20°C, 120Hz)	
Low Temperature Characteristics (Max. Impedance Ratio)	Rated voltage (V _{dc})	
	25V 35V 50V 63V 80V 100V	
	Z(-25°C)/Z(+20°C)	
	Z(-40°C)/Z(+20°C)	
	2 2 2 2 2 2	
	4 4 4 4 4 4 (at 120Hz)	
Endurance 1	The following specifications shall be satisfied when the capacitors are restored to 20°C after subjected to DC voltage with the rated ripple current is applied (the peak voltage shall not exceed the rated voltage) for the specified period of time at 125°C or 135°C.	
	Time	125°C 25 to 100V _{dc} : 3,000hours 135°C 25 to 50V _{dc} : 3,000hours 63 to 100V _{dc} : 2,000hours
	Capacitance change	≤ ±30% of the initial value
	D.F. (tan δ)	≤300% of the initial specified value
	Leakage current	≤The initial specified value
Endurance 2	The following specifications shall be satisfied when the capacitors are restored to 20°C after the test condition that the rated voltage is applied for 100 hours at 150°C and DC voltage with the rated ripple current is applied (the peak voltage shall not exceed the rated voltage) for the specified period of time at 125°C or 135°C.	
	Time	125°C 25 to 100V _{dc} : 2,500hours 135°C 25 to 50V _{dc} : 2,500hours 63 to 100V _{dc} : 1,500hours
	Capacitance change	≤ ±30% of the initial value
	D.F. (tan δ)	≤300% of the initial specified value
	Leakage current	≤The initial specified value
Shelf Life	The following specifications shall be satisfied when the capacitors are restored to 20°C after exposing them for 1,000 hours at 125°C without voltage applied. Before the measurement, the capacitor shall be preconditioned by applying voltage according to Item 4.1 of JIS C 5101-4.	
	Capacitance change	≤ ±30% of the initial value
	D.F. (tan δ)	≤300% of the initial specified value
	Leakage current	≤The initial specified value
Vibration	The following specifications shall be satisfied when the capacitors are restored to 20°C after subjected to vibration test (vibration profile shown below) at room temperature (15 to 35°C).	
	Capacitance change	≤ ±5% of the initial value
	D.F. (tan δ)	≤The initial specified value
	Leakage current	≤The initial specified value
	Vibration profile	
	Vibration frequency range	10 to 2,000Hz
	Amplitude or Acceleration	1.5mm peak to peak or 392m/s ² (40G), whichever is the less severe
	Sweep rate	10 to 2,000 to 10Hz 0.5 octave/minute
	Direction and period of motion	2 hours in each of 3 mutually perpendicular directions (total of 6hours)
	Fixation	Fix main body and Lead terminal using a fixture tool, please contact us for detail.

DIMENSIONS [mm]

- Terminal Code : E

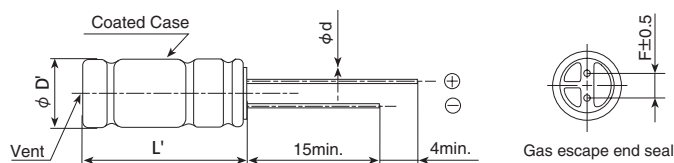

ϕD	18
ϕd	0.8
F	7.5
ϕD'	ϕD+0.5max.
L'	L+1.5max.

* Please contact us about lead formings and mounting methods.



GVD Series

◆ PART NUMBERING SYSTEM

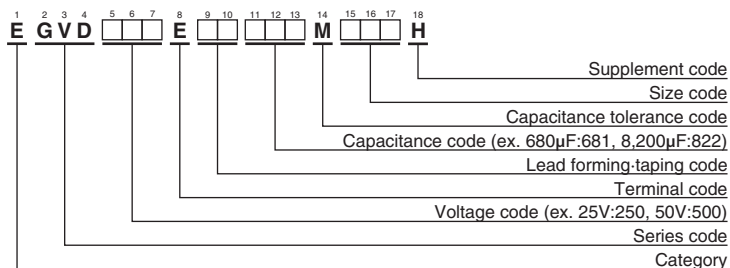

Please refer to "Product code guide (radial lead type)"

◆ STANDARD RATINGS

WV (V _{dc})	Cap (μF)	Case size φ D×L(mm)	ESR (Ω _{max} /100kHz)		Rated ripple current (mA _{rms} /100kHz)		Part No.
			20°C	-40°C	125°C	135°C	
25	6,200	18×30	0.023	0.19	5,380	3,330	EGVD250E□□622MM30H
	8,200	18×35.5	0.019	0.13	6,110	3,750	EGVD250E□□822MMP1H
35	3,600	18×30	0.023	0.19	5,380	3,330	EGVD350E□□362MM30H
	4,700	18×35.5	0.019	0.13	6,110	3,750	EGVD350E□□472MMP1H
50	2,000	18×30	0.029	0.26	5,050	2,910	EGVD500E□□202MM30H
	2,400	18×35.5	0.024	0.20	5,760	3,330	EGVD500E□□242MMP1H
63	1,300	18×30	0.029	0.18	3,930	3,100	EGVD630E□□132MM30H
	1,800	18×35.5	0.024	0.14	4,920	3,520	EGVD630E□□182MMP1H
80	820	18×30	0.029	0.18	3,930	3,100	EGVD800E□□821MM30H
	1,200	18×35.5	0.024	0.14	4,920	3,520	EGVD800E□□122MMP1H
100	510	18×30	0.038	0.25	3,800	2,830	EGVD101E□□511MM30H
	680	18×35.5	0.030	0.19	4,550	3,210	EGVD101E□□681MMP1H

□□ : Enter the appropriate lead forming or taping code.

◆ RATED RIPPLE CURRENT MULTIPLIERS

● Frequency Multipliers

Capacitance(μF)	Frequency(Hz)			
	120	1k	10k	100k
510	0.50	0.85	0.94	1.00
680 to 2,000	0.60	0.87	0.95	1.00
2,400 to 3,600	0.75	0.90	0.95	1.00
4,700 to 8,200	0.85	0.95	0.98	1.00

Please contact us for lifetime estimation.



LBK Series

- Downsizing of LBG series.
- For airbag application and power supply application
- High capacitance, low ESR and good low temperature behavior
- Endurance with ripple current : 5,000 hours at 105°C
- Solvent resistant type (see PRECAUTIONS AND GUIDELINES)
- RoHS Compliant
- AEC-Q200 compliant : Please contact Chemi-Con for more details, test data, information.



◆ SPECIFICATIONS

Items	Characteristics		
Category	-55 to +105°C		
Temperature Range			
Rated Voltage Range	25 & 35V _{dc}		
Capacitance Range	2,500 to 14,000µF (at 20°C, 120Hz)		
Capacitance Tolerance	0 to +30% (A) (at 20°C, 120Hz)		
Leakage Current	I=0.01CV Where, I : Max. leakage current (µA), C : Nominal capacitance (µF), V : Rated voltage (V) (at 20°C after 2 minutes)		
Dissipation Factor (tan δ)	Rated voltage (V _{dc})	25V	35V
	tan δ (Max.)	0.20	0.16
	When nominal capacitance exceeds 1,000µF, add 0.02 to the value above for each 1,000µF increase. (at 20°C, 120Hz)		
Low Temperature Characteristics (Max. Impedance Ratio)	Rated voltage (V _{dc})	25V	35V
	Z(-55°C)/Z(+20°C)	3	3
	(at 120Hz)		
Endurance	The following specifications shall be satisfied when the capacitors are restored to 20°C after subjected to DC voltage with the rated ripple current is applied (the peak voltage shall not exceed the rated voltage) for 5,000 hours at 105°C.		
	Capacitance change	≤ ±20% of the initial value	
	D.F. (tan δ)	≤ 200% of the initial specified value	
	Leakage current	≤ The initial specified value	
Shelf Life	The following specifications shall be satisfied when the capacitors are restored to 20°C after exposing them for 1,000 hours at 105°C without voltage applied. Before the measurement, the capacitor shall be preconditioned by applying voltage according to Item 4.1 of JIS C 5101-4.		
	Capacitance change	≤ ±20% of the initial value	
	D.F. (tan δ)	≤ 200% of the initial specified value	
	Leakage current	≤ The initial specified value	

◆ DIMENSIONS [mm]

- Terminal Code : E

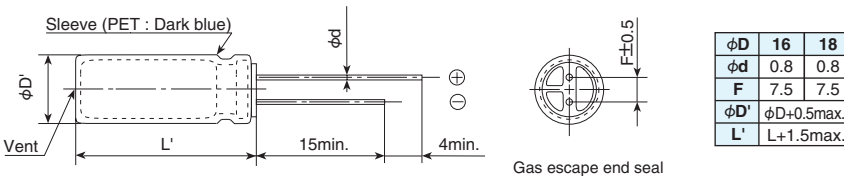

◆ PART NUMBERING SYSTEM

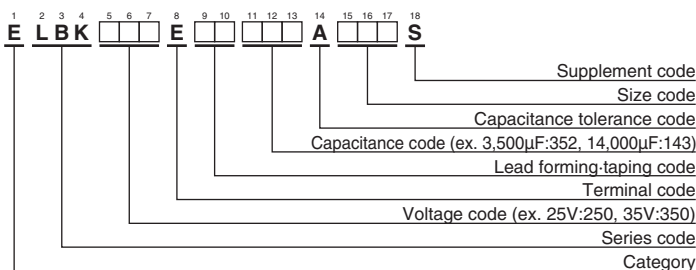

Please refer to "Product code guide (radial lead type)"

Return Group Chart



MINIATURE ALUMINUM ELECTROLYTIC CAPACITORS

For airbag module, 105°C

LBK Series

◆STANDARD RATINGS

WV (V _{dc})	Cap (μF)	Case size φD×L (mm)	ESR (Ω max./100kHz)		Rated ripple current (mA _{rms} /105°C, 100kHz)	Part No.
			20°C	-40°C		
25	4,200	16 × 20	0.033	0.095	2,250	ELBK250E□□422AL20S
	5,300	18 × 20	0.029	0.082	2,500	ELBK250E□□532AM20S
	5,900	16 × 25	0.024	0.073	2,600	ELBK250E□□592AL25S
	7,500	18 × 25	0.022	0.063	2,800	ELBK250E□□752AM25S
	8,000	16 × 31.5	0.021	0.052	3,200	ELBK250E□□802ALN3S
	9,500	16 × 35.5	0.019	0.046	3,500	ELBK250E□□952ALP1S
	10,000	18 × 31.5	0.019	0.045	3,500	ELBK250E□□103AMN3S
	11,000	16 × 40	0.017	0.040	3,800	ELBK250E□□113AL40S
	11,000	18 × 35.5	0.017	0.040	3,700	ELBK250E□□113AMP1S
14,000	18 × 40	0.015	0.035	4,000	ELBK250E□□143AM40S	
35	2,500	16 × 20	0.033	0.095	2,250	ELBK350E□□252AL20S
	3,100	18 × 20	0.029	0.082	2,500	ELBK350E□□312AM20S
	3,500	16 × 25	0.024	0.073	2,600	ELBK350E□□352AL25S
	4,500	18 × 25	0.022	0.063	2,800	ELBK350E□□452AM25S
	4,700	16 × 31.5	0.021	0.052	3,200	ELBK350E□□472ALN3S
	5,600	16 × 35.5	0.019	0.046	3,500	ELBK350E□□562ALP1S
	6,000	18 × 31.5	0.019	0.045	3,500	ELBK350E□□602AMN3S
	6,600	16 × 40	0.017	0.040	3,800	ELBK350E□□662AL40S
	7,100	18 × 35.5	0.017	0.040	3,700	ELBK350E□□712AMP1S
8,400	18 × 40	0.015	0.035	4,000	ELBK350E□□842AM40S	

□□ : Enter the appropriate lead forming or taping code.

◆RATED RIPPLE CURRENT MULTIPLIERS

● Frequency Multipliers

Capacitance(μF)	Frequency(Hz)			
	120	1k	10k	100k
2,500 to 3,500	0.75	0.90	0.95	1.00
4,200 to 14,000	0.85	0.95	0.98	1.00

The endurance of capacitors is reduced with internal heating produced by ripple current at the rate of halving the lifetime with every 5°C rise. When long life performance is required in actual use, the rms ripple current has to be reduced.

Return Group Chart



MINIATURE ALUMINUM ELECTROLYTIC CAPACITORS

For airbag module, 105°C

LBG Series

- For airbag application
- High capacitance, low impedance, and good low temperature behavior
- Endurance with ripple current : 5,000 hours at 105°C
- Solvent resistant type (see PRECAUTIONS AND GUIDELINES)
- RoHS Compliant
- AEC-Q200 compliant : Please contact Chemi-Con for more details, test data, information.



◆ SPECIFICATIONS

Items	Characteristics	
Category	-55 to +105°C	
Temperature Range	-55 to +105°C	
Rated Voltage Range	25 & 35V _{dc}	
Capacitance Range	1,000 to 11,000μF (at 20°C, 120Hz)	
Capacitance Tolerance	0 to +30% (A) (at 20°C, 120Hz)	
Leakage Current	I=0.01CV Where, I : Max. leakage current (μA), C : Nominal capacitance (μF), V : Rated voltage (V) (at 20°C after 2 minutes)	
Dissipation Factor (tan δ)	Rated voltage (V _{dc})	25V 35V
	tan δ (Max.)	0.20 0.16
	When nominal capacitance exceeds 1,000μF, add 0.02 to the value above for each 1,000μF increase. (at 20°C, 120Hz)	
Low Temperature Characteristics (Max. Impedance Ratio)	Rated voltage (V _{dc})	25V 35V
	Z(-55°C)/Z(+20°C)	3 3
	Impedance at -40°C and 20°C 100kHz in the STANDARD RATINGS (at 120Hz)	
Endurance	The following specifications shall be satisfied when the capacitors are restored to 20°C after subjected to DC voltage with the rated ripple current is applied (the peak voltage shall not exceed the rated voltage) for 5,000 hours at 105°C.	
	Capacitance change	≤ ±20% of the initial value
	D.F. (tan δ)	≤200% of the initial specified value
	Leakage current	≤ The initial specified value
Shelf Life	The following specifications shall be satisfied when the capacitors are restored to 20°C after exposing them for 1,000 hours at 105°C without voltage applied. Before the measurement, the capacitor shall be preconditioned by applying voltage according to Item 4.1 of JIS C 5101-4.	
	Capacitance change	≤ ±20% of the initial value
	D.F. (tan δ)	≤200% of the initial specified value
	Leakage current	≤ The initial specified value

◆ DIMENSIONS [mm]

- Terminal Code : E

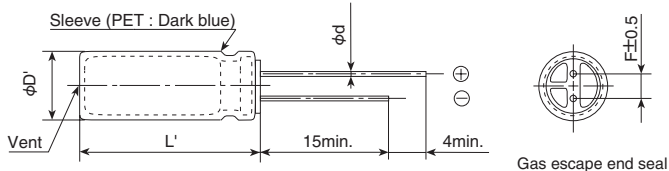

	12.5	14.5	16	18
φD	12.5	14.5	16	18
φd	0.6	0.8	0.8	0.8
F	5.0	7.5	7.5	7.5
φD'	φD+0.5max.			
L'	L+1.5max.			

◆ PART NUMBERING SYSTEM

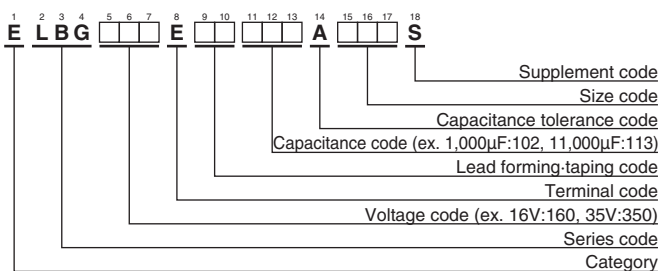

Please refer to "Product code guide (radial lead type)"

Return Group Chart



MINIATURE ALUMINUM ELECTROLYTIC CAPACITORS

For airbag module, 105°C

LBG Series

◆STANDARD RATINGS

WV (V _{dc})	Cap (μF)	Case size φD×L(mm)	Impedance (Ω max./100kHz)		Rated ripple current (mA rms/105°C, 100kHz)	Part No.
			20°C	-40°C		
25	1,700	12.5 × 20	0.057	0.29	1,700	ELBG250E □□ 172AK20S
	2,400	12.5 × 25	0.045	0.23	2,000	ELBG250E □□ 242AK25S
	2,400	14.5 × 20	0.051	0.26	2,000	ELBG250E □□ 242AU20S
	2,800	12.5 × 30	0.039	0.20	2,300	ELBG250E □□ 282AK30S
	3,000	16 × 20	0.044	0.22	2,250	ELBG250E □□ 302AL20S
	3,400	14.5 × 25	0.041	0.21	2,400	ELBG250E □□ 342AU25S
	3,500	12.5 × 35	0.033	0.17	2,700	ELBG250E □□ 352AK35S
	4,200	16 × 25	0.033	0.17	2,600	ELBG250E □□ 422AL25S
	4,200	18 × 20	0.042	0.21	2,500	ELBG250E □□ 422AM20S
	4,500	12.5 × 40	0.027	0.14	3,100	ELBG250E □□ 452AK40S
	4,600	14.5 × 31.5	0.032	0.16	2,700	ELBG250E □□ 462AUN3S
	5,400	14.5 × 35.5	0.028	0.14	3,100	ELBG250E □□ 542AUP1S
	5,600	16 × 31.5	0.026	0.13	3,200	ELBG250E □□ 562ALN3S
	6,000	18 × 25	0.030	0.15	2,800	ELBG250E □□ 602AM25S
	6,400	14.5 × 40	0.025	0.13	3,400	ELBG250E □□ 642AU40S
	6,600	16 × 35.5	0.023	0.12	3,500	ELBG250E □□ 662ALP1S
	7,800	16 × 40	0.021	0.11	3,800	ELBG250E □□ 782AL40S
7,900	18 × 31.5	0.024	0.12	3,500	ELBG250E □□ 792AMN3S	
9,200	18 × 35.5	0.022	0.11	3,700	ELBG250E □□ 922AMP1S	
11,000	18 × 40	0.020	0.10	4,000	ELBG250E □□ 113AM40S	
35	1,000	12.5 × 20	0.057	0.29	1,700	ELBG350E □□ 102AK20S
	1,400	12.5 × 25	0.045	0.23	2,000	ELBG350E □□ 142AK25S
	1,400	14.5 × 20	0.051	0.26	2,000	ELBG350E □□ 142AU20S
	1,600	12.5 × 30	0.039	0.20	2,300	ELBG350E □□ 162AK30S
	1,800	16 × 20	0.044	0.22	2,250	ELBG350E □□ 182AL20S
	2,000	14.5 × 25	0.041	0.21	2,400	ELBG350E □□ 202AU25S
	2,100	12.5 × 35	0.033	0.17	2,700	ELBG350E □□ 212AK35S
	2,500	16 × 25	0.033	0.17	2,600	ELBG350E □□ 252AL25S
	2,500	18 × 20	0.042	0.21	2,500	ELBG350E □□ 252AM20S
	2,700	12.5 × 40	0.027	0.14	3,100	ELBG350E □□ 272AK40S
	2,800	14.5 × 31.5	0.032	0.16	2,700	ELBG350E □□ 282AUN3S
	3,200	14.5 × 35.5	0.028	0.14	3,100	ELBG350E □□ 322AUP1S
	3,400	16 × 31.5	0.026	0.13	3,200	ELBG350E □□ 342ALN3S
	3,600	18 × 25	0.030	0.15	2,800	ELBG350E □□ 362AM25S
	3,800	14.5 × 40	0.025	0.13	3,400	ELBG350E □□ 382AU40S
	4,000	16 × 35.5	0.023	0.12	3,500	ELBG350E □□ 402ALP1S
	4,700	16 × 40	0.021	0.11	3,800	ELBG350E □□ 472AL40S
4,800	18 × 31.5	0.024	0.12	3,500	ELBG350E □□ 482AMN3S	
5,600	18 × 35.5	0.022	0.11	3,700	ELBG350E □□ 562AMP1S	
6,700	18 × 40	0.020	0.10	4,000	ELBG350E □□ 672AM40S	

□□ : Enter the appropriate lead forming or taping code.

◆RATED RIPPLE CURRENT MULTIPLIERS

● Frequency Multipliers

Capacitance(μF) \ Frequency(Hz)	120	1k	10k	100k
1,000 to 2,000	0.60	0.87	0.95	1.00
2,100 to 3,800	0.75	0.90	0.95	1.00
4,000 to 11,000	0.85	0.95	0.98	1.00

The endurance of capacitors is reduced with internal heating produced by ripple current at the rate of halving the lifetime with every 5°C rise. When long life performance is required in actual use, the rms ripple current has to be reduced.

Return Group Chart



MINIATURE ALUMINUM ELECTROLYTIC CAPACITORS

For photo flash

PH Series

- The PH series capacitors are designed for photo flash
- RoHS Compliant



◆ SPECIFICATIONS

Items	Characteristics
Category	-20 to +65°C
Temperature Range	
Rated Voltage Range	300, 315, 330V _{dc}
Capacitance Tolerance	-10 to +20% (V) (at 20°C, 120Hz)
Leakage Current	$I=1 \times C$ Where, I : Max. leakage current (μA), C : Nominal capacitance (μF) (at 20°C after 5 minutes)
Dissipation Factor (tan δ)	0.06max. (at 20°C, 120Hz)
Charge and Discharge Characteristics	The following specifications shall be satisfied when the capacitors are restored to 20°C after charge and discharge are repeated 5,000 times at room temperature (5 to 35°C). Discharge resistance or Xenon tube : 0.7 to 1.0Ω.
	Capacitance change ≤ ±10% of the initial value
	D.F. (tan δ) ≤ 150% of the initial specified value
	Leakage current ≤ 150% of the initial specified value
Shelf Life	The following specifications shall be satisfied when the capacitors are restored to 20°C after exposing them for 1,000 hours at 65°C without voltage applied. Before the measurement, the capacitor shall be preconditioned by applying voltage according to Item 4.1 of JIS C 5101-4.
	Capacitance change ≤ ±10% of the initial value
	D.F. (tan δ) ≤ 150% of the initial specified value
	Leakage current ≤ 150% of the initial specified value

◆ DIMENSIONS [mm]

- Terminal Code : E

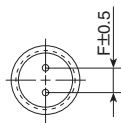
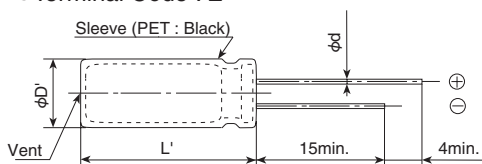

φD	6.0 to 7.5	8.0 to 8.5	9.0 to 9.5	10.0 to 14.0	14.5 to 18.0
φd	0.5	0.6	0.6	0.6	0.8
F	2.5	3.5	4	5	7.5
φD'	φD+0.5max.				
L'	L+1.0max.				

◆ PART NUMBERING SYSTEM

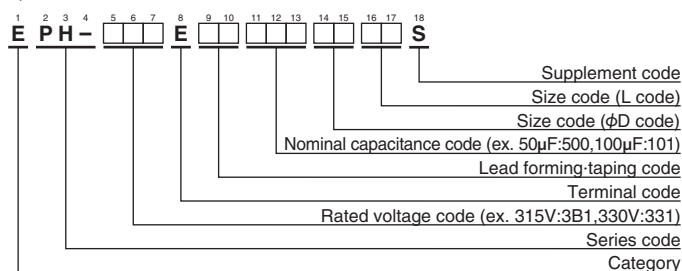

Please refer to "Product code guide (radial lead type)"

● Size Code

φD code (14th, 15th)

φD(mm)	φD code	
	14th	15th
6.0	6	0
6.5	6	5
7.0	7	0
7.5	7	5
8.0	8	0
8.5	8	5
9.0	9	0
9.5	9	5
10.0	A	0
10.5	A	5
11.0	B	0
11.5	B	5
12.0	C	0
12.5	C	5
13.0	D	0
13.5	D	5
14.0	E	0
14.5	E	5
15.0	F	0
15.5	F	5
16.0	G	0
16.5	G	5
17.0	H	0
17.5	H	5
18.0	J	0

L code (16th, 17th)

L(mm)	L code	
	16th	17th
15.0	1	5
16.0	1	6
17.0	1	7
18.0	1	8
19.0	1	9
20.0	2	0
21.0	2	1
22.0	2	2
23.0	2	3
24.0	2	4
25.0	2	5
26.0	2	6
27.0	2	7
28.0	2	8
29.0	2	9
30.0	3	0
31.0	3	1
32.0	3	2
33.0	3	3
34.0	3	4
35.0	3	5
36.0	3	6
37.0	3	7
38.0	3	8
39.0	3	9
40.0	4	0
41.0	4	1
42.0	4	2
43.0	4	3
44.0	4	4
45.0	4	5



PHSeries

◆ **RATINGS (REFERENCE)**

WV (V _{dc})	Cap (μF)	Case size φD×L(mm)	tan δ	Part No.
315	86	10 × 30	0.06	EPH-3B1E □□ 860A030S
	122	10 × 40	0.06	EPH-3B1E □□ 121A040S
	144	12.5 × 30	0.06	EPH-3B1E □□ 1E1C530S
	209	12.5 × 40	0.06	EPH-3B1E □□ 211C540S
330	80	10 × 30	0.06	EPH-331E □□ 800A030S
	114	10 × 40	0.06	EPH-331E □□ 1B1A040S
	137	12.5 × 30	0.06	EPH-331E □□ 1D1C530S
	194	12.5 × 40	0.06	EPH-331E □□ 1K1C540S

□□ : Enter the appropriate lead forming or taping code.

● **Products of vents on the sealing rubber**

DIMENSIONS[mm]

<In the case of diameter 10mm>

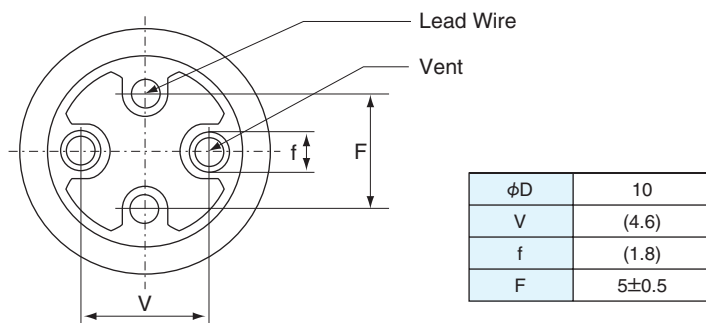

Products of vent on rubber type, please make clearance about 1mm minimum between rubber and board. If it is difficult to make clearance 1mm minimum between rubber and board, please arrange gas escaping hole on the board (same position and 40% minimum diameter from the vent).

The products of dual vents on rubber, requires placement one or two gas escaping hole on the board.

● **Products of a vent on the case**

Please make the following open space over the vent so that the vent can operate correctly.

Case diameter	Clearance
φ6 to 16mm	2mm minimum
φ16.5mm and up	3mm minimum

Above part numbers are only reference.

Please consult with us about detail specifications (rated voltage, capacitance, case size, type of rubber, etc...).

NIPPON CHEMI-CON

PART NUMBERING SYSTEM

Product code guide (Snap-in type)

(Example : KMM series, 400V-220 μ F, ϕ 30 \times 30L)

Please refer to the following table



For more details, refer to Product Guide (P16).

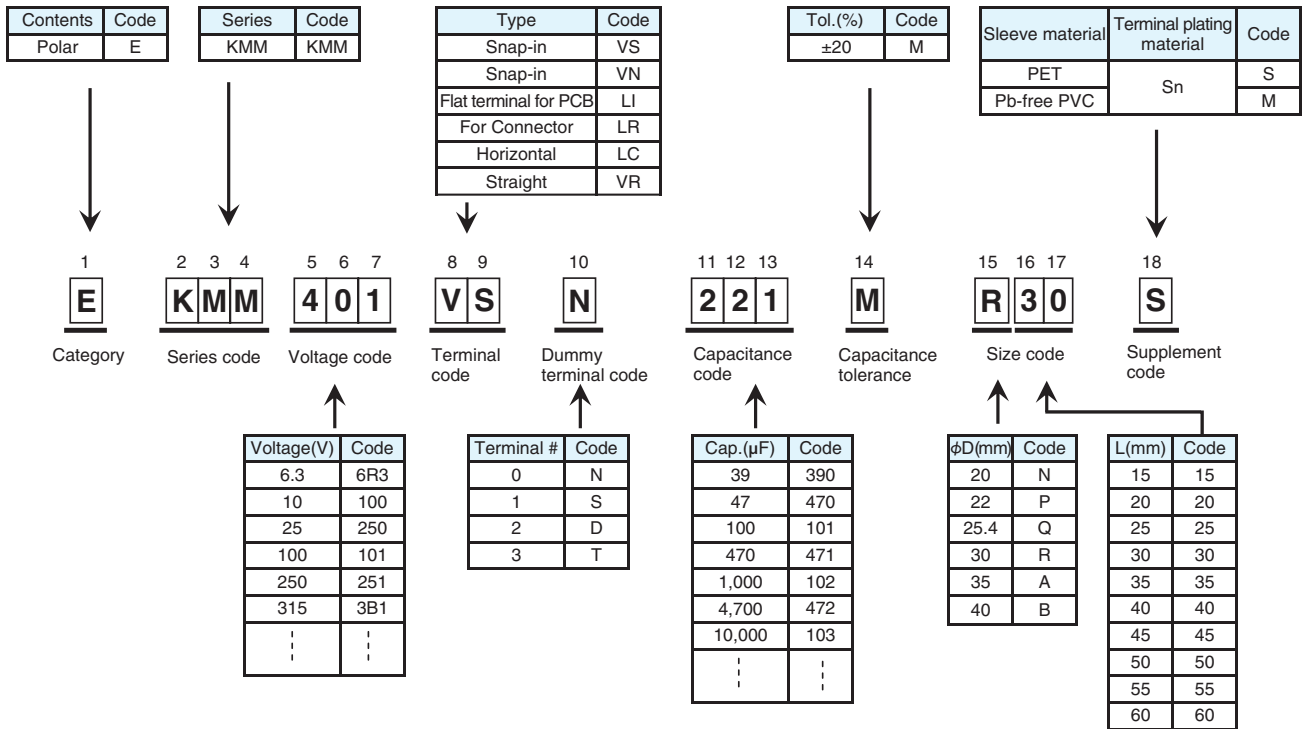

*Refer to the appendix (Part number) for codes not listed here.

Available terminals

[mm]

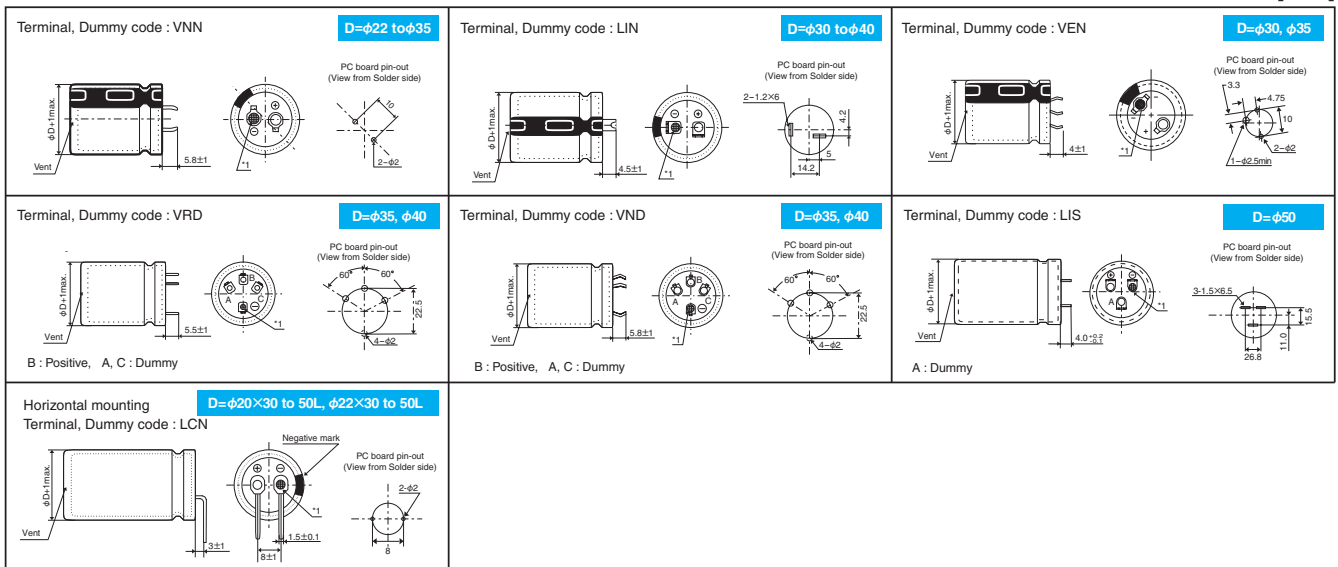

*1 Negative terminal : Mesh marking

*2 Use the dummy terminals for mechanical support only.

The dummy terminals must not be connected to any circuit trace on PC board, be sure to electrically isolate from the negative and the positive terminals.

Return Group Chart



LARGE CAPACITANCE ALUMINUM ELECTROLYTIC CAPACITORS

Downsized snap-ins, 85°C

SMR Series

- Endurance with ripple current : 2,000 hours at 85°C
- Downsized and high ripple current from SMQ series
- Non solvent resistant type
- RoHS Compliant

SMR

↑
Downsized
Higher ripple
SMQ P233



SPECIFICATIONS

Items	Characteristics		
Category	-25 to +85°C		
Temperature Range	-25 to +85°C		
Rated Voltage Range	400 to 450V _{dc}		
Capacitance Tolerance	±20% (M) (at 20°C, 120Hz)		
Leakage Current	$I \leq 3\sqrt{CV}$ Where, I : Max. leakage current (μA), C : Nominal capacitance (μF), V : Rated voltage (V) (at 20°C after 5 minutes)		
Dissipation Factor (tan δ)	Rated voltage (V _{dc})	400V	420 & 450V
	tan δ (Max.)	0.15	0.20
Low Temperature Characteristics (Max. Impedance Ratio)	Rated voltage (V _{dc})	400 to 450V	
	Z(-25°C)/Z(+20°C)	8	
Endurance	The following specifications shall be satisfied when the capacitors are restored to 20°C after subjected to DC voltage with the rated ripple current is applied (the peak voltage shall not exceed the rated voltage) for 2,000 hours at 85°C.		
	Capacitance change	≤ ±20% of the initial value	
	D. F. (tan δ)	≤ 200% of the initial specified value	
	Leakage current	≤ The initial specified value	
Shelf Life	The following specifications shall be satisfied when the capacitors are restored to 20°C after exposing them for 1,000 hours at 85°C without voltage applied. Before the measurement, the capacitor shall be preconditioned by applying voltage according to Item 4.1 of JIS C 5101-4.		
	Capacitance change	≤ ±15% of the initial value	
	D. F. (tan δ)	≤ 150% of the initial specified value	
	Leakage current	≤ The initial specified value	

DIMENSIONS [mm]

● Terminal Code : VS (φ22 to φ35) : Standard

● Terminal Code : LI (φ35)

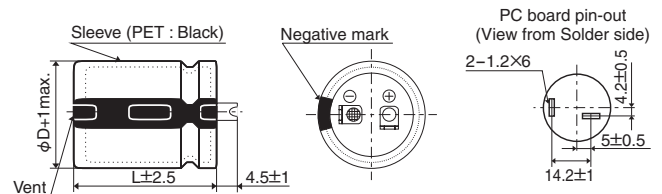
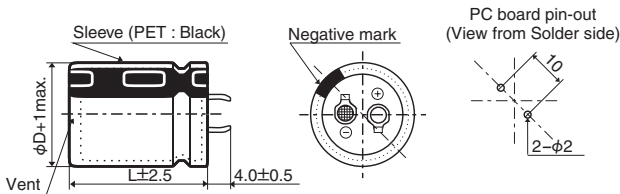

The standard design has no plastic disc.

PART NUMBERING SYSTEM

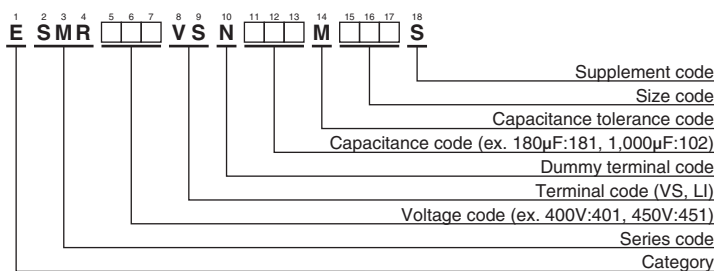

Please refer to "Product code guide (snap-in type)"

Return Group Chart



LARGE CAPACITANCE ALUMINUM ELECTROLYTIC CAPACITORS

Downsized snap-ins, 85°C

SMRSeries

◆STANDARD RATINGS

WV (V _{dc})	Cap (μF)	Case size φD×L(mm)	tan δ	Rated ripple current (Arms/85°C, 120Hz)	Part No.	WV (V _{dc})	Cap (μF)	Case size φD×L(mm)	tan δ	Rated ripple current (Arms/85°C, 120Hz)	Part No.	
400	150	22 × 25	0.15	1.30	ESMR401VSN151MP25S	420	330	35 × 25	0.20	1.99	ESMR421VSN331MA25S	
	180	22 × 30	0.15	1.49	ESMR401VSN181MP30S		390	25.4 × 45	0.20	2.47	ESMR421VSN391MQ45S	
	220	22 × 35	0.15	1.69	ESMR401VSN221MP35S		390	30 × 35	0.20	2.32	ESMR421VSN391MR35S	
	220	25.4 × 25	0.15	1.65	ESMR401VSN221MQ25S		470	25.4 × 50	0.20	2.77	ESMR421VSN471MQ50S	
	270	22 × 40	0.15	1.90	ESMR401VSN271MP40S		470	30 × 40	0.20	2.61	ESMR421VSN471MR40S	
	270	25.4 × 30	0.15	1.88	ESMR401VSN271MQ30S		470	35 × 30	0.20	2.41	ESMR421VSN471MA30S	
	330	22 × 45	0.15	2.15	ESMR401VSN331MP45S		560	30 × 45	0.20	2.93	ESMR421VSN561MR45S	
	330	25.4 × 35	0.15	2.16	ESMR401VSN331MQ35S		560	35 × 35	0.20	2.67	ESMR421VSN561MA35S	
	330	30 × 25	0.15	2.10	ESMR401VSN331MR25S		680	30 × 50	0.20	3.28	ESMR421VSN681MR50S	
	390	22 × 50	0.15	2.40	ESMR401VSN391MP50S		680	35 × 40	0.20	3.11	ESMR421VSN681MA40S	
	390	25.4 × 40	0.15	2.40	ESMR401VSN391MQ40S		820	35 × 45	0.20	3.43	ESMR421VSN821MA45S	
	390	30 × 30	0.15	2.32	ESMR401VSN391MR30S		450	120	22 × 25	0.20	1.12	ESMR451VSN121MP25S
	390	35 × 25	0.15	2.05	ESMR401VSN391MA25S			150	22 × 30	0.20	1.32	ESMR451VSN151MP30S
	470	25.4 × 45	0.15	2.69	ESMR401VSN471MQ45S			180	22 × 35	0.20	1.49	ESMR451VSN181MP35S
	470	30 × 35	0.15	2.60	ESMR401VSN471MR35S			180	25.4 × 25	0.20	1.42	ESMR451VSN181MQ25S
	470	35 × 30	0.15	2.28	ESMR401VSN471MA30S			220	22 × 40	0.20	1.67	ESMR451VSN221MP40S
	560	30 × 40	0.15	2.92	ESMR401VSN561MR40S			220	25.4 × 30	0.20	1.66	ESMR451VSN221MQ30S
	560	35 × 30	0.15	2.48	ESMR401VSN561MA30S			220	30 × 25	0.20	1.68	ESMR451VSN221MR25S
	680	30 × 45	0.15	3.30	ESMR401VSN681MR45S			270	22 × 45	0.20	1.88	ESMR451VSN271MP45S
	680	35 × 35	0.15	2.79	ESMR401VSN681MA35S			270	25.4 × 35	0.20	1.87	ESMR451VSN271MQ35S
820	35 × 45	0.15	3.25	ESMR401VSN821MA45S	330	25.4 × 40		0.20	2.11	ESMR451VSN331MQ40S		
1,000	35 × 50	0.15	3.66	ESMR401VSN102MA50S	330	30 × 30		0.20	2.10	ESMR451VSN331MR30S		
420	120	22 × 25	0.20	1.15	ESMR421VSN121MP25S	330		35 × 25	0.20	2.10	ESMR451VSN331MA25S	
	180	22 × 30	0.20	1.48	ESMR421VSN181MP30S	390		25.4 × 50	0.20	2.37	ESMR451VSN391MQ50S	
	180	25.4 × 25	0.20	1.51	ESMR421VSN181MQ25S	390		30 × 35	0.20	2.32	ESMR451VSN391MR35S	
	220	22 × 35	0.20	1.68	ESMR421VSN221MP35S	390		35 × 30	0.20	2.32	ESMR451VSN391MA30S	
	220	25.4 × 30	0.20	1.71	ESMR421VSN221MQ30S	470		30 × 40	0.20	2.66	ESMR451VSN471MR40S	
	270	22 × 45	0.20	1.94	ESMR421VSN271MP45S	470		35 × 35	0.20	2.54	ESMR451VSN471MA35S	
	270	25.4 × 35	0.20	1.99	ESMR421VSN271MQ35S	560		30 × 45	0.20	2.93	ESMR451VSN561MR45S	
	270	30 × 25	0.20	1.87	ESMR421VSN271MR25S	560		35 × 40	0.20	2.87	ESMR451VSN561MA40S	
	330	22 × 50	0.20	2.20	ESMR421VSN331MP50S	680		35 × 45	0.20	3.21	ESMR451VSN681MA45S	
	330	25.4 × 40	0.20	2.24	ESMR421VSN331MQ40S	820	35 × 50	0.20	3.60	ESMR451VSN821MA50S		
	330	30 × 30	0.20	2.08	ESMR421VSN331MR30S							

◆RATED RIPPLE CURRENT MULTIPLIERS

●Frequency Multipliers

Frequency(Hz)	50	120	300	1k	10k	50k
400 to 450V _{dc}	0.77	1.00	1.16	1.30	1.41	1.43

The endurance of capacitors is reduced with internal heating produced by ripple current at the rate of halving the lifetime with every 5°C rise. When long life performance is required in actual use, the rms ripple current has to be reduced.

Return Group Chart



LARGE CAPACITANCE ALUMINUM ELECTROLYTIC CAPACITORS

Standard snap-ins, 85°C

SMQ Series

- Endurance with ripple current : 2,000 hours at 85°C
- Non solvent resistant type
- RoHS Compliant

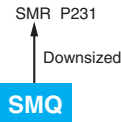

SPECIFICATIONS

Items	Characteristics			
Category	-25 to +85°C			
Temperature Range	-25 to +85°C			
Rated Voltage Range	160 to 450V _{dc}			
Capacitance Tolerance	±20% (M) (at 20°C, 120Hz)			
Leakage Current	I ≤ 3√CV Where, I : Max. leakage current (µA), C : Nominal capacitance (µF), V : Rated voltage (V) (at 20°C after 5 minutes)			
Dissipation Factor (tan δ)	Rated voltage (V _{dc})	160 to 250V	315 to 400V	420 & 450V
	tan δ (Max.)	0.15	0.15	0.20 (at 20°C, 120Hz)
Low Temperature Characteristics (Max. Impedance Ratio)	Rated voltage (V _{dc})	160 to 250V	315 to 400V	420 & 450V
	Z(-25°C)/Z(+20°C)	4	8	8 (at 120Hz)
Endurance	The following specifications shall be satisfied when the capacitors are restored to 20°C after subjected to DC voltage with the rated ripple current is applied (the peak voltage shall not exceed the rated voltage) for 2,000 hours at 85°C.			
	Capacitance change	≤ ±20% of the initial value		
	D. F. (tan δ)	≤ 200% of the initial specified value		
	Leakage current	≤ The initial specified value		
Shelf Life	The following specifications shall be satisfied when the capacitors are restored to 20°C after exposing them for 1,000 hours at 85°C without voltage applied. Before the measurement, the capacitor shall be preconditioned by applying voltage according to Item 4.1 of JIS C 5101-4.			
	Capacitance change	≤ ±15% of the initial value		
	D. F. (tan δ)	≤ 150% of the initial specified value		
	Leakage current	≤ The initial specified value		

DIMENSIONS [mm]

Terminal Code : VS (φ22 to φ35) : Standard

Terminal Code : LI (φ35)

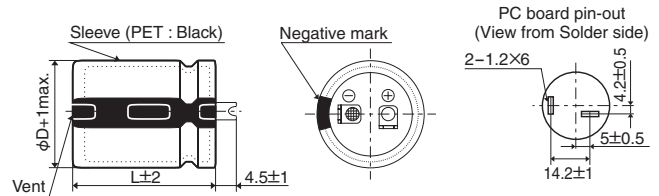
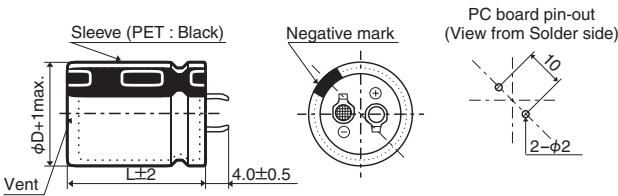

The standard design has no plastic disc.

PART NUMBERING SYSTEM

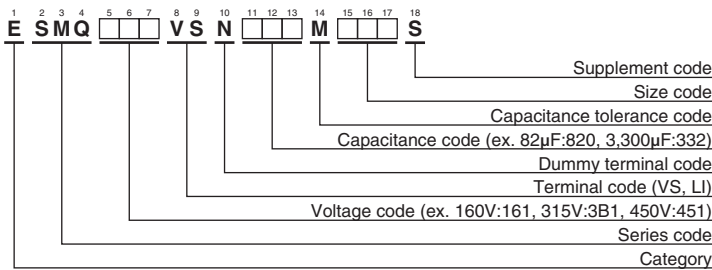

Please refer to "Product code guide (snap-in type)"

Return Group Chart



LARGE CAPACITANCE ALUMINUM ELECTROLYTIC CAPACITORS

Standard snap-ins, 85°C



◆ STANDARD RATINGS

WV (V _{dc})	Cap (μF)	Case size φD×L(mm)	tan δ	Rated ripple current (Arms/ 85°C, 120Hz)	Part No.	WV (V _{dc})	Cap (μF)	Case size φD×L(mm)	tan δ	Rated ripple current (Arms/ 85°C, 120Hz)	Part No.
160	560	22 × 25	0.15	2.25	ESMQ161VSN561MP25S	250	270	22 × 25	0.15	1.31	ESMQ251VSN271MP25S
	680	22 × 30	0.15	2.50	ESMQ161VSN681MP30S		330	22 × 30	0.15	1.75	ESMQ251VSN331MP30S
	820	22 × 35	0.15	2.75	ESMQ161VSN821MP35S		390	22 × 30	0.15	1.91	ESMQ251VSN391MP30S
	1,000	22 × 40	0.15	3.00	ESMQ161VSN102MP40S		390	25.4 × 25	0.15	1.91	ESMQ251VSN391MQ25S
	1,000	25.4 × 30	0.15	3.00	ESMQ161VSN102MQ30S		470	22 × 35	0.15	2.11	ESMQ251VSN471MP35S
	1,200	22 × 45	0.15	3.25	ESMQ161VSN122MP45S		470	25.4 × 30	0.15	2.11	ESMQ251VSN471MQ30S
	1,200	25.4 × 35	0.15	3.25	ESMQ161VSN122MQ35S		560	22 × 40	0.15	2.25	ESMQ251VSN561MP40S
	1,200	30 × 25	0.15	3.25	ESMQ161VSN122MR25S		560	25.4 × 30	0.15	2.25	ESMQ251VSN561MQ30S
	1,500	22 × 50	0.15	3.73	ESMQ161VSN152MP50S		560	30 × 25	0.15	2.25	ESMQ251VSN561MR25S
	1,500	25.4 × 40	0.15	3.73	ESMQ161VSN152MQ40S		680	22 × 45	0.15	2.50	ESMQ251VSN681MP45S
	1,500	30 × 30	0.15	3.73	ESMQ161VSN152MR30S		680	25.4 × 35	0.15	2.50	ESMQ251VSN681MQ35S
	1,500	35 × 25	0.15	3.73	ESMQ161VSN152MA25S		680	30 × 30	0.15	2.50	ESMQ251VSN681MR30S
	1,800	25.4 × 45	0.15	4.20	ESMQ161VSN182MQ45S		820	22 × 50	0.15	2.77	ESMQ251VSN821MP50S
	1,800	30 × 35	0.15	4.20	ESMQ161VSN182MR35S		820	25.4 × 40	0.15	2.77	ESMQ251VSN821MQ40S
	1,800	35 × 30	0.15	4.20	ESMQ161VSN182MA30S		820	30 × 30	0.15	2.77	ESMQ251VSN821MR30S
	2,200	30 × 40	0.15	4.78	ESMQ161VSN222MR40S		820	35 × 25	0.15	2.77	ESMQ251VSN821MA25S
	2,200	35 × 35	0.15	4.78	ESMQ161VSN222MA35S		1,000	25.4 × 45	0.15	3.32	ESMQ251VSN102MQ45S
	2,700	35 × 40	0.15	5.45	ESMQ161VSN272MA40S		1,000	30 × 35	0.15	3.32	ESMQ251VSN102MR35S
3,300	35 × 45	0.15	5.75	ESMQ161VSN332MA45S	1,000	35 × 30	0.15	3.32	ESMQ251VSN102MA30S		
3,900	35 × 50	0.15	6.00	ESMQ161VSN392MA50S	1,200	30 × 40	0.15	3.53	ESMQ251VSN122MR40S		
180	470	22 × 25	0.15	2.08	ESMQ181VSN471MP25S	1,200	35 × 35	0.15	3.53	ESMQ251VSN122MA35S	
	560	22 × 30	0.15	2.25	ESMQ181VSN561MP30S	1,500	30 × 50	0.15	4.04	ESMQ251VSN152MR50S	
	680	22 × 30	0.15	2.50	ESMQ181VSN681MP30S	1,500	35 × 40	0.15	4.04	ESMQ251VSN152MA40S	
	680	25.4 × 25	0.15	2.50	ESMQ181VSN681MQ25S	1,800	35 × 45	0.15	4.55	ESMQ251VSN182MA45S	
	820	22 × 35	0.15	2.75	ESMQ181VSN821MP35S	315	180	22 × 25	0.15	1.21	ESMQ3B1VSN181MP25S
	820	25.4 × 30	0.15	2.75	ESMQ181VSN821MQ30S		220	22 × 30	0.15	1.41	ESMQ3B1VSN221MP30S
	1,000	22 × 45	0.15	3.00	ESMQ181VSN102MP45S		270	22 × 30	0.15	1.60	ESMQ3B1VSN271MP30S
	1,000	25.4 × 35	0.15	3.00	ESMQ181VSN102MQ35S		330	22 × 40	0.15	1.82	ESMQ3B1VSN331MP40S
	1,000	30 × 25	0.15	3.00	ESMQ181VSN102MR25S		330	25.4 × 30	0.15	1.82	ESMQ3B1VSN331MQ30S
	1,200	22 × 50	0.15	3.31	ESMQ181VSN122MP50S		330	30 × 25	0.15	1.82	ESMQ3B1VSN331MR25S
	1,200	25.4 × 40	0.15	3.31	ESMQ181VSN122MQ40S		390	22 × 45	0.15	2.01	ESMQ3B1VSN391MP45S
	1,200	30 × 30	0.15	3.31	ESMQ181VSN122MR30S		390	25.4 × 35	0.15	2.01	ESMQ3B1VSN391MQ35S
	1,200	35 × 25	0.15	3.31	ESMQ181VSN122MA25S		390	30 × 30	0.15	2.01	ESMQ3B1VSN391MR30S
	1,500	25.4 × 45	0.15	3.83	ESMQ181VSN152MQ45S		470	22 × 50	0.15	2.27	ESMQ3B1VSN471MP50S
	1,500	30 × 35	0.15	3.83	ESMQ181VSN152MR35S		470	25.4 × 40	0.15	2.27	ESMQ3B1VSN471MQ40S
	1,500	35 × 30	0.15	3.83	ESMQ181VSN152MA30S		470	30 × 30	0.15	2.27	ESMQ3B1VSN471MR30S
	1,800	25.4 × 50	0.15	4.32	ESMQ181VSN182MQ50S		470	35 × 25	0.15	2.27	ESMQ3B1VSN471MA25S
	1,800	30 × 40	0.15	4.32	ESMQ181VSN182MR40S		560	25.4 × 45	0.15	2.56	ESMQ3B1VSN561MQ45S
1,800	35 × 30	0.15	4.32	ESMQ181VSN182MA30S	560		30 × 35	0.15	2.56	ESMQ3B1VSN561MR35S	
2,200	30 × 45	0.15	4.92	ESMQ181VSN222MR45S	560		35 × 30	0.15	2.56	ESMQ3B1VSN561MA30S	
2,200	35 × 40	0.15	4.92	ESMQ181VSN222MA40S	680		30 × 40	0.15	2.87	ESMQ3B1VSN681MR40S	
2,700	35 × 45	0.15	5.52	ESMQ181VSN272MA45S	680		35 × 35	0.15	2.87	ESMQ3B1VSN681MA35S	
3,300	35 × 50	0.15	5.75	ESMQ181VSN332MA50S	820	30 × 45	0.15	3.25	ESMQ3B1VSN821MR45S		
200	390	22 × 25	0.15	1.68	ESMQ201VSN391MP25S	820	35 × 40	0.15	3.25	ESMQ3B1VSN821MA40S	
	470	22 × 30	0.15	1.85	ESMQ201VSN471MP30S	1,000	30 × 50	0.15	3.63	ESMQ3B1VSN102MR50S	
	560	22 × 30	0.15	2.43	ESMQ201VSN561MP30S	1,000	35 × 45	0.15	3.63	ESMQ3B1VSN102MA45S	
	560	25.4 × 25	0.15	2.43	ESMQ201VSN561MQ25S	350	150	22 × 25	0.15	1.12	ESMQ351VSN151MP25S
	680	22 × 35	0.15	2.68	ESMQ201VSN681MP35S		180	22 × 30	0.15	1.22	ESMQ351VSN181MP30S
	680	25.4 × 30	0.15	2.68	ESMQ201VSN681MQ30S		220	22 × 35	0.15	1.44	ESMQ351VSN221MP35S
	820	22 × 40	0.15	2.93	ESMQ201VSN821MP40S		270	22 × 40	0.15	1.66	ESMQ351VSN271MP40S
	820	25.4 × 30	0.15	2.93	ESMQ201VSN821MQ30S		270	25.4 × 30	0.15	1.66	ESMQ351VSN271MQ30S
	820	30 × 25	0.15	2.93	ESMQ201VSN821MR25S		330	22 × 45	0.15	1.88	ESMQ351VSN331MP45S
	1,000	22 × 45	0.15	3.25	ESMQ201VSN102MP45S		330	25.4 × 35	0.15	1.88	ESMQ351VSN331MQ35S
	1,000	25.4 × 35	0.15	3.25	ESMQ201VSN102MQ35S		390	22 × 50	0.15	2.06	ESMQ351VSN391MP50S
	1,000	30 × 30	0.15	3.25	ESMQ201VSN102MR30S		390	25.4 × 40	0.15	2.06	ESMQ351VSN391MQ40S
	1,000	35 × 25	0.15	3.25	ESMQ201VSN102MA25S		390	30 × 30	0.15	2.06	ESMQ351VSN391MR30S
	1,200	25.4 × 40	0.15	3.50	ESMQ201VSN122MQ40S		390	35 × 25	0.15	2.06	ESMQ351VSN391MA25S
	1,200	30 × 30	0.15	3.50	ESMQ201VSN122MR30S		470	25.4 × 45	0.15	2.40	ESMQ351VSN471MQ45S
	1,200	35 × 30	0.15	3.50	ESMQ201VSN122MA30S		470	30 × 35	0.15	2.40	ESMQ351VSN471MR35S
	1,500	25.4 × 50	0.15	3.87	ESMQ201VSN152MQ50S		470	35 × 30	0.15	2.40	ESMQ351VSN471MA30S
	1,500	30 × 35	0.15	3.87	ESMQ201VSN152MR35S		560	25.4 × 50	0.15	2.60	ESMQ351VSN561MQ50S
1,500	35 × 30	0.15	3.87	ESMQ201VSN152MA30S	560		30 × 40	0.15	2.60	ESMQ351VSN561MR40S	
1,800	30 × 45	0.15	4.32	ESMQ201VSN182MR45S	560		35 × 30	0.15	2.60	ESMQ351VSN561MA30S	
1,800	35 × 35	0.15	4.32	ESMQ201VSN182MA35S	680		30 × 45	0.15	2.96	ESMQ351VSN681MR45S	
2,200	30 × 50	0.15	4.92	ESMQ201VSN222MR50S	680	35 × 35	0.15	2.96	ESMQ351VSN681MA35S		
2,200	35 × 40	0.15	4.92	ESMQ201VSN222MA40S	820	30 × 50	0.15	3.25	ESMQ351VSN821MR50S		
2,700	35 × 50	0.15	5.45	ESMQ201VSN272MA50S	820	35 × 45	0.15	3.25	ESMQ351VSN821MA45S		

Return Group Chart



LARGE CAPACITANCE ALUMINUM ELECTROLYTIC CAPACITORS

Standard snap-ins, 85°C

SMQSeries

◆STANDARD RATINGS

WV (V _{dc})	Cap (μF)	Case size φD×L(mm)	tan δ	Rated ripple current (Arms/85°C, 120Hz)	Part No.	WV (V _{dc})	Cap (μF)	Case size φD×L(mm)	tan δ	Rated ripple current (Arms/85°C, 120Hz)	Part No.	
350	1,000	35 × 50	0.15	3.54	ESMQ351VSN102MA50S	420	270	30 × 30	0.20	1.94	ESMQ421VSN271MR30S	
	120	22 × 25	0.15	1.02	ESMQ401VSN121MP25S		330	25.4 × 45	0.20	2.17	ESMQ421VSN331MQ45S	
	150	22 × 30	0.15	1.16	ESMQ401VSN151MP30S		330	30 × 35	0.20	2.17	ESMQ421VSN331MR35S	
	180	22 × 35	0.15	1.44	ESMQ401VSN181MP35S		330	35 × 30	0.20	2.17	ESMQ421VSN331MA30S	
	220	22 × 40	0.15	1.49	ESMQ401VSN221MP40S		390	25.4 × 50	0.20	2.27	ESMQ421VSN391MQ50S	
	220	25.4 × 30	0.15	1.49	ESMQ401VSN221MQ30S		390	30 × 35	0.20	2.27	ESMQ421VSN391MR35S	
	270	22 × 45	0.15	1.67	ESMQ401VSN271MP45S		390	35 × 30	0.20	2.27	ESMQ421VSN391MA30S	
	270	25.4 × 35	0.15	1.67	ESMQ401VSN271MQ35S		470	30 × 40	0.20	2.61	ESMQ421VSN471MR40S	
	270	30 × 25	0.15	1.67	ESMQ401VSN271MR25S		470	35 × 35	0.20	2.61	ESMQ421VSN471MA35S	
	330	22 × 50	0.15	1.90	ESMQ401VSN331MP50S		560	30 × 50	0.20	2.82	ESMQ421VSN561MR50S	
	330	25.4 × 40	0.15	1.90	ESMQ401VSN331MQ40S		560	35 × 40	0.20	2.82	ESMQ421VSN561MA40S	
	330	30 × 30	0.15	1.90	ESMQ401VSN331MR30S		680	35 × 45	0.20	3.11	ESMQ421VSN681MA45S	
	330	35 × 25	0.15	1.90	ESMQ401VSN331MA25S		450	82	22 × 25	0.20	0.83	ESMQ451VSN820MP25S
	390	25.4 × 45	0.15	2.13	ESMQ401VSN391MQ45S			100	22 × 25	0.20	0.93	ESMQ451VSN101MP25S
	390	30 × 35	0.15	2.13	ESMQ401VSN391MR35S			120	22 × 30	0.20	1.04	ESMQ451VSN121MP30S
	390	35 × 30	0.15	2.13	ESMQ401VSN391MA30S			150	22 × 35	0.20	1.19	ESMQ451VSN151MP35S
470	25.4 × 50	0.15	2.39	ESMQ401VSN471MQ50S	150	25.4 × 25		0.20	1.19	ESMQ451VSN151MQ25S		
470	30 × 40	0.15	2.39	ESMQ401VSN471MR40S	180	22 × 40		0.20	1.35	ESMQ451VSN181MP40S		
470	35 × 30	0.15	2.39	ESMQ401VSN471MA30S	180	25.4 × 30		0.20	1.35	ESMQ451VSN181MQ30S		
560	30 × 45	0.15	2.69	ESMQ401VSN561MR45S	220	22 × 45		0.20	1.55	ESMQ451VSN221MP45S		
560	35 × 35	0.15	2.69	ESMQ401VSN561MA35S	220	25.4 × 40		0.20	1.55	ESMQ451VSN221MQ40S		
680	30 × 50	0.15	2.96	ESMQ401VSN681MR50S	220	30 × 30		0.20	1.55	ESMQ451VSN221MR30S		
680	35 × 40	0.15	2.96	ESMQ401VSN681MA40S	220	35 × 25		0.20	1.55	ESMQ451VSN221MA25S		
820	35 × 45	0.15	3.25	ESMQ401VSN821MA45S	270	22 × 50		0.20	1.78	ESMQ451VSN271MP50S		
400	100	22 × 25	0.20	0.97	ESMQ421VSN101MP25S	270		25.4 × 40	0.20	1.78	ESMQ451VSN271MQ40S	
	120	22 × 25	0.20	1.08	ESMQ421VSN121MP25S	270		30 × 30	0.20	1.78	ESMQ451VSN271MR30S	
	150	22 × 30	0.20	1.30	ESMQ421VSN151MP30S	330		25.4 × 50	0.20	2.01	ESMQ451VSN331MQ50S	
	150	25.4 × 25	0.20	1.30	ESMQ421VSN151MQ25S	330		30 × 40	0.20	2.01	ESMQ451VSN331MR40S	
	180	22 × 35	0.20	1.48	ESMQ421VSN181MP35S	330	35 × 30	0.20	2.01	ESMQ451VSN331MA30S		
	180	25.4 × 30	0.20	1.48	ESMQ421VSN181MQ30S	390	30 × 40	0.20	2.24	ESMQ451VSN391MR40S		
	220	22 × 40	0.20	1.65	ESMQ421VSN221MP40S	390	35 × 35	0.20	2.24	ESMQ451VSN391MA35S		
	220	25.4 × 35	0.20	1.65	ESMQ421VSN221MQ35S	470	30 × 45	0.20	2.53	ESMQ451VSN471MR45S		
	220	30 × 25	0.20	1.65	ESMQ421VSN221MR25S	470	35 × 40	0.20	2.53	ESMQ451VSN471MA40S		
	270	22 × 50	0.20	1.94	ESMQ421VSN271MP50S	560	30 × 50	0.20	2.82	ESMQ451VSN561MR50S		
270	25.4 × 35	0.20	1.94	ESMQ421VSN271MQ35S	560	35 × 45	0.20	2.82	ESMQ451VSN561MA45S			

◆RATED RIPPLE CURRENT MULTIPLIERS

●Frequency Multipliers

Frequency(Hz)	50	120	300	1k	10k	50k
160 to 250V _{dc}	0.81	1.00	1.17	1.32	1.45	1.50
315 to 450V _{dc}	0.77	1.00	1.16	1.30	1.41	1.43

The endurance of capacitors is reduced with internal heating produced by ripple current at the rate of halving the lifetime with every 5°C rise. When long life performance is required in actual use, the rms ripple current has to be reduced.

Return Group Chart



LARGE CAPACITANCE ALUMINUM ELECTROLYTIC CAPACITORS

Downsized snap-ins, 105°C

KMZ Series New!

- Downsized from KMW series
- Endurance with ripple current : 2,000 hours at 105°C
- Rated voltage range : 420 & 450V_{dc}, Capacitance range : 120 to 820μF
- Non solvent resistant type
- RoHS Compliant

KMZ

↓ Downsized

KMW P238



◆ SPECIFICATIONS

Items	Characteristics	
Category	-25 to +105°C	
Temperature Range		
Rated Voltage Range	420 & 450V _{dc}	
Capacitance Tolerance	±20% (M) (at 20°C, 120Hz)	
Leakage Current	$I \leq 3\sqrt{CV}$ Where, I : Max. leakage current (μA), C : Nominal capacitance (μF), V : Rated voltage (V) (at 20°C after 5 minutes)	
Dissipation Factor (tan δ)	Rated voltage (V _{dc})	420 & 450V
	tan δ (Max.)	0.20 (at 20°C, 120Hz)
Low Temperature Characteristics (Max. Impedance Ratio)	Rated voltage (V _{dc})	420 & 450V
	Z(-25°C)/Z(+20°C)	8 (at 120Hz)
Endurance	The following specifications shall be satisfied when the capacitors are restored to 20°C after subjected to DC voltage with the rated ripple current is applied (the peak voltage shall not exceed the rated voltage) for 2,000 hours at 105°C.	
	Capacitance change	≤ ±20% of the initial value
	D.F. (tan δ)	≤ 200% of the initial specified value
	Leakage current	≤ The initial specified value
Shelf Life	The following specifications shall be satisfied when the capacitors are restored to 20°C after exposing them for 1,000 hours at 105°C without voltage applied. Before the measurement, the capacitor shall be preconditioned by applying voltage according to Item 4.1 of JIS C 5101-4.	
	Capacitance change	≤ ±15% of the initial value
	D.F. (tan δ)	≤ 150% of the initial specified value
	Leakage current	≤ The initial specified value

◆ DIMENSIONS [mm]

- Terminal Code : VS (φ22 to φ30) : Standard

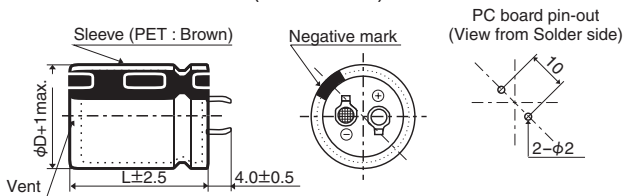

The standard design has no plastic disc.

◆ PART NUMBERING SYSTEM

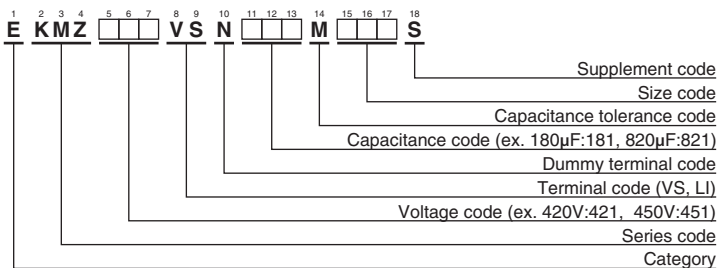

Please refer to "Product code guide (snap-in type)"

Return Group Chart



LARGE CAPACITANCE ALUMINUM ELECTROLYTIC CAPACITORS

Downsized snap-ins, 105°C

KMZ New!
Series

◆STANDARD RATINGS

WV (V _{dc})	Cap (μF)	Case size φD×L(mm)	tan δ	Rated ripple current (Arms/105°C, 120Hz)	Part No.	WV (V _{dc})	Cap (μF)	Case size φD×L(mm)	tan δ	Rated ripple current (Arms/105°C, 120Hz)	Part No.
420	150	22 × 25	0.20	0.87	EKMZ421VSN151MP25S	450	120	22 × 25	0.20	0.78	EKMZ451VSN121MP25S
	180	22 × 30	0.20	1.00	EKMZ421VSN181MP30S		180	22 × 30	0.20	1.00	EKMZ451VSN181MP30S
	180	25.4 × 25	0.20	1.02	EKMZ421VSN181MQ25S		180	25.4 × 25	0.20	1.02	EKMZ451VSN181MQ25S
	220	22 × 35	0.20	1.13	EKMZ421VSN221MP35S		220	22 × 35	0.20	1.13	EKMZ451VSN221MP35S
	270	22 × 40	0.20	1.27	EKMZ421VSN271MP40S		220	25.4 × 30	0.20	1.16	EKMZ451VSN221MQ30S
	270	25.4 × 30	0.20	1.28	EKMZ421VSN271MQ30S		270	22 × 45	0.20	1.30	EKMZ451VSN271MP45S
	270	30 × 25	0.20	1.28	EKMZ421VSN271MR25S		270	25.4 × 35	0.20	1.34	EKMZ451VSN271MQ35S
	330	22 × 45	0.20	1.44	EKMZ421VSN331MP45S		270	30 × 25	0.20	1.28	EKMZ451VSN271MR25S
	330	25.4 × 35	0.20	1.48	EKMZ421VSN331MQ35S		330	22 × 50	0.20	1.47	EKMZ451VSN331MP50S
	390	22 × 55	0.20	1.63	EKMZ421VSN391MP55S		330	25.4 × 40	0.20	1.51	EKMZ451VSN331MQ40S
	390	25.4 × 40	0.20	1.64	EKMZ421VSN391MQ40S		330	30 × 30	0.20	1.43	EKMZ451VSN331MR30S
	390	30 × 30	0.20	1.55	EKMZ421VSN391MR30S		390	22 × 55	0.20	1.63	EKMZ451VSN391MP55S
	470	25.4 × 50	0.20	1.86	EKMZ421VSN471MQ50S		390	25.4 × 45	0.20	1.67	EKMZ451VSN391MQ45S
	470	30 × 35	0.20	1.74	EKMZ421VSN471MR35S		390	30 × 35	0.20	1.59	EKMZ451VSN391MR35S
	560	25.4 × 55	0.20	2.09	EKMZ421VSN561MQ55S		470	25.4 × 55	0.20	1.91	EKMZ451VSN471MQ55S
	560	30 × 40	0.20	1.96	EKMZ421VSN561MR40S		470	30 × 40	0.20	1.79	EKMZ451VSN471MR40S
680	30 × 50	0.20	2.25	EKMZ421VSN681MR50S	560	25.4 × 60	0.20	2.13	EKMZ451VSN561MQ60S		
820	30 × 55	0.20	2.52	EKMZ421VSN821MR55S	560	30 × 45	0.20	2.01	EKMZ451VSN561MR45S		
						680	30 × 50	0.20	2.25	EKMZ451VSN681MR50S	
						820	30 × 60	0.20	2.56	EKMZ451VSN821MR60S	

◆RATED RIPPLE CURRENT MULTIPLIERS

⊙ Frequency Multipliers

Frequency(Hz)	50	120	300	1k	10k	50k
Multipliers	0.77	1.00	1.16	1.30	1.41	1.43

The endurance of capacitors is reduced with internal heating produced by ripple current at the rate of halving the lifetime with every 5°C rise. When long life performance is required in actual use, the rms ripple current has to be reduced.

Return Group Chart



LARGE CAPACITANCE ALUMINUM ELECTROLYTIC CAPACITORS

Downsized snap-ins, 105°C

KMW Series

- Downsized from KMR series
- Endurance with ripple current : 2,000 hours at 105°C
- Rated voltage range : 400 to 450V_{dc}, Capacitance range : 120 to 1,000μF
- Non solvent resistant type
- RoHS Compliant

KMW

Downsized

KMR P240



◆ SPECIFICATIONS

Items	Characteristics		
Category	-25 to +105°C		
Temperature Range	-25 to +105°C		
Rated Voltage Range	160 to 450V _{dc}		
Capacitance Tolerance	±20% (M) (at 20°C, 120Hz)		
Leakage Current	$I \leq 3\sqrt{CV}$ Where, I : Max. leakage current (μA), C : Nominal capacitance (μF), V : Rated voltage (V) (at 20°C after 5 minutes)		
Dissipation Factor (tan δ)	Rated voltage (V _{dc})	400V	420 & 450V
	tan δ (Max.)	0.15	0.20
Low Temperature Characteristics (Max. Impedance Ratio)	Rated voltage (V _{dc})	400 to 450V	
	Z(-25°C)/Z(+20°C)	8	
Endurance	The following specifications shall be satisfied when the capacitors are restored to 20°C after subjected to DC voltage with the rated ripple current is applied (the peak voltage shall not exceed the rated voltage) for 2,000 hours at 105°C.		
	Capacitance change	≤ ±20% of the initial value	
	D.F. (tan δ)	≤ 200% of the initial specified value	
	Leakage current	≤ The initial specified value	
Shelf Life	The following specifications shall be satisfied when the capacitors are restored to 20°C after exposing them for 1,000 hours at 105°C without voltage applied. Before the measurement, the capacitor shall be preconditioned by applying voltage according to Item 4.1 of JIS C 5101-4.		
	Capacitance change	≤ ±15% of the initial value	
	D.F. (tan δ)	≤ 150% of the initial specified value	
	Leakage current	≤ The initial specified value	

◆ DIMENSIONS [mm]

● Terminal Code : VS (φ22 to φ35) : Standard

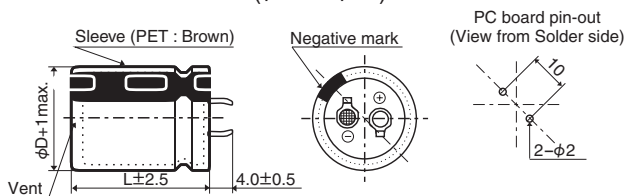

● Terminal Code : LI (φ35)

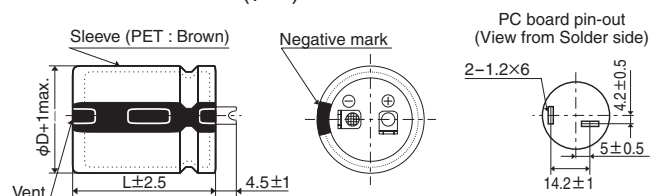

The standard design has no plastic disc.

◆ PART NUMBERING SYSTEM

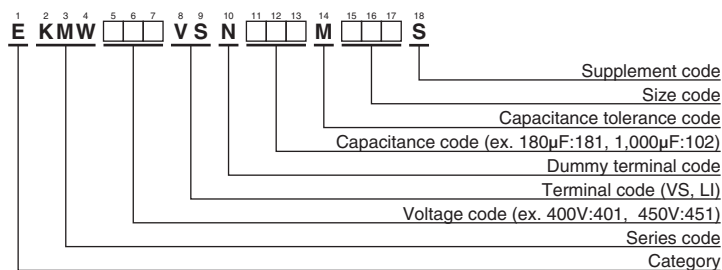

Please refer to "Product code guide (snap-in type)"

Return Group Chart



LARGE CAPACITANCE ALUMINUM ELECTROLYTIC CAPACITORS

Downsized snap-ins, 105°C

KMW Series

◆STANDARD RATINGS

WV (V _{dc})	Cap (μF)	Case size φD×L(mm)	tan δ	Rated ripple current (Arms/105°C, 120Hz)	Part No.	WV (V _{dc})	Cap (μF)	Case size φD×L(mm)	tan δ	Rated ripple current (Arms/105°C, 120Hz)	Part No.
400	150	22 × 25	0.15	0.91	EKMW401VSN151MP25S	420	330	35 × 25	0.20	1.38	EKMW421VSN331MA25S
	180	22 × 30	0.15	1.04	EKMW401VSN181MP30S		390	25.4 × 45	0.20	1.67	EKMW421VSN391MQ45S
	220	22 × 35	0.15	1.18	EKMW401VSN221MP35S		390	25.4 × 50	0.20	1.70	EKMW421VSN391MQ50S
	220	25.4 × 25	0.15	1.15	EKMW401VSN221MQ25S		390	30 × 35	0.20	1.59	EKMW421VSN391MR35S
	270	25.4 × 30	0.15	1.31	EKMW401VSN271MQ30S		470	30 × 40	0.20	1.79	EKMW421VSN471MR40S
	330	22 × 45	0.15	1.50	EKMW401VSN331MP45S		470	35 × 30	0.20	1.67	EKMW421VSN471MA30S
	330	25.4 × 35	0.15	1.51	EKMW401VSN331MQ35S		560	30 × 45	0.20	2.01	EKMW421VSN561MR45S
	330	30 × 25	0.15	1.46	EKMW401VSN331MR25S		560	35 × 35	0.20	1.85	EKMW421VSN561MA35S
	390	22 × 50	0.15	1.67	EKMW401VSN391MP50S		680	35 × 40	0.20	2.11	EKMW421VSN681MA40S
	390	25.4 × 40	0.15	1.67	EKMW401VSN391MQ40S		450	120	22 × 25	0.20	0.78
	390	30 × 30	0.15	1.61	EKMW401VSN391MR30S	150		22 × 30	0.20	0.91	EKMW451VSN151MP30S
	390	35 × 25	0.15	1.40	EKMW401VSN391MA25S	150		25.4 × 25	0.20	0.93	EKMW451VSN151MQ25S
	470	25.4 × 45	0.15	1.87	EKMW401VSN471MQ45S	180		22 × 35	0.20	1.02	EKMW451VSN181MP35S
	470	30 × 35	0.15	1.81	EKMW401VSN471MR35S	180		25.4 × 30	0.20	1.05	EKMW451VSN181MQ30S
	560	30 × 40	0.15	2.03	EKMW401VSN561MR40S	220		22 × 40	0.20	1.15	EKMW451VSN221MP40S
	560	35 × 30	0.15	1.70	EKMW401VSN561MA30S	220		25.4 × 35	0.20	1.21	EKMW451VSN221MQ35S
	680	30 × 45	0.15	2.29	EKMW401VSN681MR45S	220		30 × 25	0.20	1.15	EKMW451VSN221MR25S
	680	30 × 50	0.15	2.33	EKMW401VSN681MR50S	270		22 × 50	0.20	1.36	EKMW451VSN271MP50S
	680	35 × 35	0.15	1.90	EKMW401VSN681MA35S	270		25.4 × 40	0.20	1.36	EKMW451VSN271MQ40S
	820	35 × 40	0.15	2.16	EKMW401VSN821MA40S	270	30 × 30	0.20	1.29	EKMW451VSN271MR30S	
1,000	35 × 50	0.15	2.50	EKMW401VSN102MA50S	330	25.4 × 45	0.20	1.54	EKMW451VSN331MQ45S		
420	120	22 × 25	0.20	0.78	EKMW421VSN121MP25S	330	30 × 35	0.20	1.46	EKMW451VSN331MR35S	
	150	22 × 30	0.20	0.91	EKMW421VSN151MP30S	390	25.4 × 50	0.20	1.70	EKMW451VSN391MQ50S	
	180	25.4 × 25	0.20	1.02	EKMW421VSN181MQ25S	390	30 × 40	0.20	1.63	EKMW451VSN391MR40S	
	220	25.4 × 30	0.20	1.16	EKMW421VSN221MQ30S	390	35 × 30	0.20	1.52	EKMW451VSN391MA30S	
	270	22 × 45	0.20	1.30	EKMW421VSN271MP45S	470	30 × 45	0.20	1.85	EKMW451VSN471MR45S	
	270	25.4 × 35	0.20	1.34	EKMW421VSN271MQ35S	470	35 × 35	0.20	1.77	EKMW451VSN471MA35S	
	270	30 × 25	0.20	1.28	EKMW421VSN271MR25S	560	30 × 50	0.20	2.04	EKMW451VSN561MR50S	
	330	22 × 50	0.20	1.47	EKMW421VSN331MP50S	560	35 × 40	0.20	2.02	EKMW451VSN561MA40S	
	330	25.4 × 40	0.20	1.51	EKMW421VSN331MQ40S	680	35 × 45	0.20	2.16	EKMW451VSN681MA45S	
	330	30 × 30	0.20	1.43	EKMW421VSN331MR30S	820	35 × 50	0.20	2.42	EKMW451VSN821MA50S	

◆RATED RIPPLE CURRENT MULTIPLIERS

● Frequency Multipliers

Frequency(Hz)	50	120	300	1k	10k	50k
400 to 450V _{dc}	0.77	1.00	1.16	1.30	1.41	1.43

The endurance of capacitors is reduced with internal heating produced by ripple current at the rate of halving the lifetime with every 5°C rise. When long life performance is required in actual use, the rms ripple current has to be reduced.

Return Group Chart



LARGE CAPACITANCE ALUMINUM ELECTROLYTIC CAPACITORS

Downsized snap-ins, 105°C

KMR Series

- Downsized 5mm in height from current snap-ins KMQ series
- Max. 50% up ripple current than same case size of KMQ series
- Endurance with ripple current : 2,000 hours at 105°C
- Rated voltage range : 160 to 450V_{dc}, Capacitance range : 100 to 3,300μF
- For inverter control, switching power supplies
- Non solvent resistant type
- RoHS Compliant

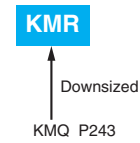

◆ SPECIFICATIONS

Items	Characteristics			
Category	-25 to +105°C			
Temperature Range	-25 to +105°C			
Rated Voltage Range	160 to 450V _{dc}			
Capacitance Tolerance	±20% (M) (at 20°C, 120Hz)			
Leakage Current	$I \leq 3\sqrt{CV}$ Where, I : Max. leakage current (μA), C : Nominal capacitance (μF), V : Rated voltage (V) (at 20°C after 5 minutes)			
Dissipation Factor (tan δ)	Rated voltage (V _{dc})	160 to 250V	315 to 400V	420 & 450V
	tan δ (Max.)	0.15	0.15	0.20
Low Temperature Characteristics (Max. Impedance Ratio)	Rated voltage (V _{dc})	160 to 250V	315 to 400V	420 & 450V
	Z(-25°C)/Z(+20°C)	4	8	8
Endurance	The following specifications shall be satisfied when the capacitors are restored to 20°C after subjected to DC voltage with the rated ripple current is applied (the peak voltage shall not exceed the rated voltage) for 2,000 hours at 105°C.			
	Capacitance change	≤ ±20% of the initial value		
	D.F. (tan δ)	≤ 200% of the initial specified value		
	Leakage current	≤ The initial specified value		
Shelf Life	The following specifications shall be satisfied when the capacitors are restored to 20°C after exposing them for 1,000 hours at 105°C without voltage applied. Before the measurement, the capacitor shall be preconditioned by applying voltage according to Item 4.1 of JIS C 5101-4.			
	Capacitance change	≤ ±15% of the initial value		
	D.F. (tan δ)	≤ 150% of the initial specified value		
	Leakage current	≤ The initial specified value		

◆ DIMENSIONS [mm]

- Terminal Code : VS (φ22 to φ35) : Standard

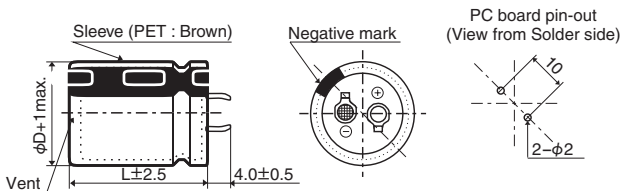

- Terminal Code : LI (φ35)

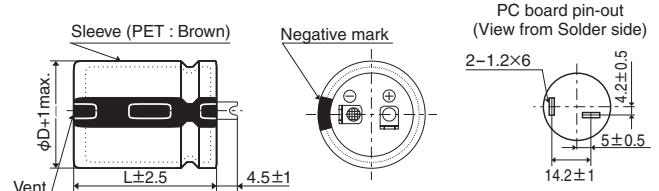

The standard design has no plastic disc.

◆ PART NUMBERING SYSTEM

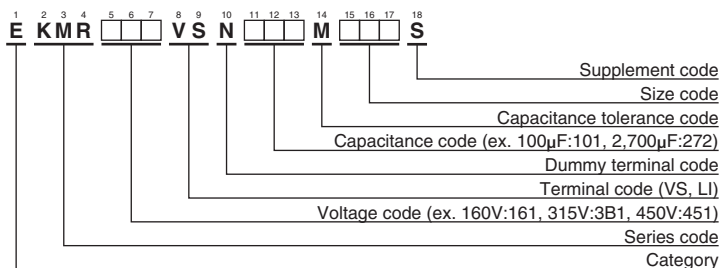

Please refer to "Product code guide (snap-in type)"

Return Group Chart



LARGE CAPACITANCE ALUMINUM ELECTROLYTIC CAPACITORS

Downsized snap-ins, 105°C

KMRSeries

◆STANDARD RATINGS

WV (V _{dc})	Cap (μF)	Case size φD×L(mm)	Rated ripple current (Arms/105°C,120Hz)	Part No.	WV (V _{dc})	Cap (μF)	Case size φD×L(mm)	Rated ripple current (Arms/105°C,120Hz)	Part No.
160	560	22 × 25	1.58	EKMR161VSN561MP25S	250	330	22 × 25	1.21	EKMR251VSN331MP25S
	680	22 × 30	1.83	EKMR161VSN681MP30S		390	22 × 30	1.38	EKMR251VSN391MP30S
	820	22 × 35	2.06	EKMR161VSN821MP35S		470	22 × 35	1.56	EKMR251VSN471MP35S
	820	25.4 × 25	1.89	EKMR161VSN821MQ25S		560	22 × 40	1.74	EKMR251VSN561MP40S
	1,000	22 × 40	2.33	EKMR161VSN102MP40S		560	25.4 × 30	1.61	EKMR251VSN561MQ30S
	1,000	25.4 × 30	2.15	EKMR161VSN102MQ30S		560	30 × 25	1.42	EKMR251VSN561MR25S
	1,000	30 × 25	1.90	EKMR161VSN102MR25S		680	22 × 45	1.97	EKMR251VSN681MP45S
	1,200	22 × 45	2.61	EKMR161VSN122MP45S		680	25.4 × 35	1.85	EKMR251VSN681MQ35S
	1,200	22 × 50	2.69	EKMR161VSN122MP50S		820	25.4 × 40	2.08	EKMR251VSN821MQ40S
	1,200	25.4 × 35	2.45	EKMR161VSN122MQ35S		820	25.4 × 45	2.13	EKMR251VSN821MQ45S
	1,500	25.4 × 40	2.82	EKMR161VSN152MQ40S		820	30 × 30	1.77	EKMR251VSN821MP30S
	1,500	25.4 × 45	2.88	EKMR161VSN152MQ45S		820	35 × 25	1.60	EKMR251VSN821MA25S
	1,500	30 × 30	2.39	EKMR161VSN152MR30S		1,000	25.4 × 50	2.40	EKMR251VSN102MQ50S
	1,500	35 × 25	2.17	EKMR161VSN152MA25S		1,000	30 × 35	2.03	EKMR251VSN102MR35S
	1,800	25.4 × 50	3.22	EKMR161VSN182MQ50S		1,200	30 × 40	2.31	EKMR251VSN122MR40S
	1,800	30 × 35	2.73	EKMR161VSN182MR35S		1,200	30 × 45	2.38	EKMR251VSN122MR45S
	1,800	30 × 40	2.82	EKMR161VSN182MR40S		1,200	35 × 35	2.06	EKMR251VSN122MA35S
	1,800	35 × 30	2.47	EKMR161VSN182MA30S		1,500	30 × 50	2.73	EKMR251VSN152MR50S
	2,200	30 × 45	3.23	EKMR161VSN222MR45S		1,500	35 × 40	2.41	EKMR251VSN152MA40S
	2,200	35 × 35	2.79	EKMR161VSN222MA35S		1,800	35 × 45	2.72	EKMR251VSN182MA45S
2,700	30 × 50	3.66	EKMR161VSN272MR50S	2,200	35 × 50	3.10	EKMR251VSN222MA50S		
2,700	35 × 40	3.23	EKMR161VSN272MA40S	315	180	22 × 25	0.91	EKMR3B1VSN181MP25S	
3,300	35 × 45	3.68	EKMR161VSN332MA45S		220	22 × 30	1.06	EKMR3B1VSN221MP30S	
470	22 × 25	1.45	EKMR181VSN471MP25S		270	22 × 35	1.20	EKMR3B1VSN271MP35S	
560	22 × 30	1.66	EKMR181VSN561MP30S		270	25.4 × 25	1.15	EKMR3B1VSN271MQ25S	
680	22 × 35	1.87	EKMR181VSN681MP35S		330	22 × 40	1.37	EKMR3B1VSN331MP40S	
680	25.4 × 25	1.72	EKMR181VSN681MQ25S		330	25.4 × 30	1.30	EKMR3B1VSN331MQ30S	
820	22 × 40	2.11	EKMR181VSN821MP40S		390	22 × 45	1.52	EKMR3B1VSN391MP45S	
820	25.4 × 30	1.94	EKMR181VSN821MQ30S		390	25.4 × 35	1.48	EKMR3B1VSN391MQ35S	
1,000	22 × 45	2.38	EKMR181VSN102MP45S		390	30 × 25	1.39	EKMR3B1VSN391MR25S	
1,000	25.4 × 35	2.24	EKMR181VSN102MQ35S		470	22 × 50	1.72	EKMR3B1VSN471MP50S	
1,000	30 × 25	1.90	EKMR181VSN102MR25S		470	25.4 × 40	1.67	EKMR3B1VSN471MQ40S	
1,200	22 × 50	2.69	EKMR181VSN122MP50S	470	30 × 30	1.57	EKMR3B1VSN471MR30S		
1,200	25.4 × 40	2.52	EKMR181VSN122MQ40S	470	35 × 25	1.52	EKMR3B1VSN471MA25S		
1,200	30 × 30	2.14	EKMR181VSN122MR30S	560	25.4 × 45	1.86	EKMR3B1VSN561MQ45S		
1,200	35 × 25	1.94	EKMR181VSN122MA25S	560	30 × 35	1.78	EKMR3B1VSN561MR35S		
1,500	25.4 × 45	2.88	EKMR181VSN152MQ45S	680	25.4 × 50	2.10	EKMR3B1VSN681MQ50S		
1,500	25.4 × 50	2.94	EKMR181VSN152MQ50S	680	30 × 40	2.03	EKMR3B1VSN681MR40S		
1,500	30 × 35	2.49	EKMR181VSN152MR35S	680	35 × 30	1.90	EKMR3B1VSN681MA30S		
1,800	30 × 40	2.82	EKMR181VSN182MR40S	820	30 × 45	2.31	EKMR3B1VSN821MR45S		
1,800	35 × 30	2.47	EKMR181VSN182MA30S	820	35 × 35	2.13	EKMR3B1VSN821MA35S		
2,200	30 × 45	3.23	EKMR181VSN222MR45S	1,000	30 × 50	2.61	EKMR3B1VSN102MR50S		
2,200	30 × 50	3.31	EKMR181VSN222MR50S	1,000	35 × 40	2.46	EKMR3B1VSN102MA40S		
2,200	35 × 35	2.79	EKMR181VSN222MA35S	1,200	35 × 45	2.78	EKMR3B1VSN122MA45S		
2,200	35 × 40	2.92	EKMR181VSN222MA40S	1,200	35 × 50	2.86	EKMR3B1VSN122MA50S		
2,700	35 × 45	3.33	EKMR181VSN272MA45S	350	150	22 × 25	0.84	EKMR351VSN151MP25S	
560	22 × 30	1.66	EKMR201VSN561MP30S		220	22 × 30	1.06	EKMR351VSN221MP30S	
560	25.4 × 25	1.56	EKMR201VSN561MQ25S		220	25.4 × 25	1.04	EKMR351VSN221MQ25S	
680	22 × 35	1.87	EKMR201VSN681MP35S		270	22 × 35	1.20	EKMR351VSN271MP35S	
680	25.4 × 30	1.77	EKMR201VSN681MQ30S		270	25.4 × 30	1.18	EKMR351VSN271MQ30S	
820	22 × 40	2.11	EKMR201VSN821MP40S		330	22 × 40	1.37	EKMR351VSN331MP40S	
820	25.4 × 35	2.03	EKMR201VSN821MQ35S		330	22 × 45	1.40	EKMR351VSN331MP45S	
820	30 × 25	1.72	EKMR201VSN821MR25S		330	25.4 × 35	1.36	EKMR351VSN331MQ35S	
1,000	22 × 50	2.45	EKMR201VSN102MP50S		330	30 × 25	1.28	EKMR351VSN331MR25S	
1,000	25.4 × 40	2.30	EKMR201VSN102MQ40S		390	22 × 50	1.56	EKMR351VSN391MP50S	
1,000	30 × 30	1.95	EKMR201VSN102MR30S		390	25.4 × 40	1.52	EKMR351VSN391MQ40S	
1,200	25.4 × 45	2.58	EKMR201VSN122MQ45S		390	30 × 30	1.43	EKMR351VSN391MR30S	
1,200	30 × 35	2.23	EKMR201VSN122MR35S		390	35 × 25	1.38	EKMR351VSN391MA25S	
1,200	35 × 25	1.94	EKMR201VSN122MA25S		470	25.4 × 45	1.71	EKMR351VSN471MQ45S	
1,500	25.4 × 50	2.94	EKMR201VSN152MQ50S		560	25.4 × 50	1.90	EKMR351VSN561MQ50S	
1,500	30 × 40	2.58	EKMR201VSN152MR40S		560	30 × 35	1.78	EKMR351VSN561MR35S	
1,500	35 × 30	2.25	EKMR201VSN152MA30S		560	30 × 40	1.84	EKMR351VSN561MR40S	
1,800	30 × 45	2.92	EKMR201VSN182MR45S		560	35 × 30	1.72	EKMR351VSN561MA30S	
1,800	35 × 35	2.53	EKMR201VSN182MA35S		680	30 × 45	2.10	EKMR351VSN681MR45S	
2,200	30 × 50	3.31	EKMR201VSN222MR50S		680	35 × 35	1.94	EKMR351VSN681MA35S	
2,200	35 × 40	2.92	EKMR201VSN222MA40S	820	30 × 50	2.36	EKMR351VSN821MR50S		
2,700	35 × 45	3.33	EKMR201VSN272MA45S						

Return Group Chart



LARGE CAPACITANCE ALUMINUM ELECTROLYTIC CAPACITORS

Downsized snap-ins, 105°C

KMRSeries

◆STANDARD RATINGS

WV (V _{dc})	Cap (μF)	Case size φD×L(mm)	Rated ripple current (Arms/105°C, 120Hz)	Part No.	WV (V _{dc})	Cap (μF)	Case size φD×L(mm)	Rated ripple current (Arms/105°C, 120Hz)	Part No.
350	820	35 × 40	2.23	EKMR351VSN821MA40S	420	270	25.4 × 40	1.32	EKMR421VSN271MQ40S
	1,000	35 × 45	2.54	EKMR351VSN102MA45S		270	30 × 30	1.26	EKMR421VSN271MR30S
	1,200	35 × 50	2.86	EKMR351VSN122MA50S		270	35 × 25	1.26	EKMR421VSN271MA25S
400	120	22 × 25	0.75	EKMR401VSN121MP25S		330	25.4 × 45	1.49	EKMR421VSN331MQ45S
	180	22 × 30	0.96	EKMR401VSN181MP30S		330	30 × 35	1.45	EKMR421VSN331MR35S
	180	25.4 × 25	0.94	EKMR401VSN181MQ25S		390	25.4 × 50	1.66	EKMR421VSN391MQ50S
	220	22 × 35	1.09	EKMR401VSN221MP35S		390	30 × 40	1.63	EKMR421VSN391MR40S
	220	25.4 × 30	1.07	EKMR401VSN221MQ30S		390	35 × 30	1.58	EKMR421VSN391MA30S
	270	22 × 40	1.24	EKMR401VSN271MP40S		470	30 × 45	1.85	EKMR421VSN471MR45S
	270	22 × 45	1.26	EKMR401VSN271MP45S		470	35 × 35	1.77	EKMR421VSN471MA35S
	270	25.4 × 35	1.23	EKMR401VSN271MQ35S		560	30 × 50	2.07	EKMR421VSN561MR50S
	270	30 × 25	1.16	EKMR401VSN271MR25S		560	35 × 40	2.02	EKMR421VSN561MA40S
	330	22 × 50	1.44	EKMR401VSN331MP50S		680	35 × 45	2.29	EKMR421VSN681MA45S
	330	25.4 × 40	1.40	EKMR401VSN331MQ40S		820	35 × 50	2.59	EKMR421VSN821MA50S
	330	30 × 30	1.31	EKMR401VSN331MR30S		450	100	22 × 25	0.71
	330	35 × 25	1.27	EKMR401VSN331MA25S	120		22 × 30	0.82	EKMR451VSN121MP30S
	390	25.4 × 45	1.55	EKMR401VSN391MQ45S	150		22 × 35	0.94	EKMR451VSN151MP35S
	390	30 × 35	1.49	EKMR401VSN391MR35S	150		25.4 × 25	0.89	EKMR451VSN151MQ25S
	470	25.4 × 50	1.74	EKMR401VSN471MQ50S	180		22 × 40	1.05	EKMR451VSN181MP40S
	470	30 × 40	1.69	EKMR401VSN471MR40S	180		25.4 × 30	1.00	EKMR451VSN181MQ30S
	470	35 × 30	1.58	EKMR401VSN471MA30S	220		22 × 45	1.19	EKMR451VSN221MP45S
	560	30 × 45	1.91	EKMR401VSN561MR45S	220		25.4 × 35	1.16	EKMR451VSN221MQ35S
	560	35 × 35	1.76	EKMR401VSN561MA35S	220		30 × 25	1.11	EKMR451VSN221MR25S
	680	30 × 50	2.15	EKMR401VSN681MR50S	270		22 × 50	1.36	EKMR451VSN271MP50S
680	35 × 40	2.03	EKMR401VSN681MA40S	270	25.4 × 40		1.32	EKMR451VSN271MQ40S	
820	35 × 45	2.30	EKMR401VSN821MA45S	270	25.4 × 45		1.35	EKMR451VSN271MQ45S	
820	35 × 50	2.37	EKMR401VSN821MA50S	270	30 × 30		1.26	EKMR451VSN271MR30S	
1,000	35 × 50	2.50	EKMR401VSN102MA50S	270	35 × 25		1.26	EKMR451VSN271MA25S	
420	120	22 × 25	0.78	EKMR421VSN121MP25S	330		25.4 × 50	1.52	EKMR451VSN331MQ50S
	150	22 × 30	0.91	EKMR421VSN151MP30S	330		30 × 35	1.45	EKMR451VSN331MR35S
	150	25.4 × 25	0.89	EKMR421VSN151MQ25S	330		35 × 30	1.45	EKMR451VSN331MA30S
	180	22 × 35	1.03	EKMR421VSN181MP35S	390		30 × 40	1.63	EKMR451VSN391MR40S
	180	25.4 × 30	1.00	EKMR421VSN181MQ30S	470		30 × 45	1.85	EKMR451VSN471MR45S
	220	22 × 40	1.16	EKMR421VSN221MP40S	470		30 × 50	1.90	EKMR451VSN471MR50S
	220	22 × 45	1.19	EKMR421VSN221MP45S	470		35 × 35	1.77	EKMR451VSN471MA35S
	220	25.4 × 35	1.16	EKMR421VSN221MQ35S	560	35 × 40	2.02	EKMR451VSN561MA40S	
	220	30 × 25	1.11	EKMR421VSN221MR25S	560	35 × 45	2.08	EKMR451VSN561MA45S	
	270	22 × 50	1.36	EKMR421VSN271MP50S	680	35 × 50	2.36	EKMR451VSN681MA50S	

◆RATED RIPPLE CURRENT MULTIPLIERS

●Frequency Multipliers

Frequency(Hz)	50	120	300	1k	10k	50k
160 to 250V _{dc}	0.81	1.00	1.17	1.32	1.45	1.50
315 to 450V _{dc}	0.77	1.00	1.16	1.30	1.41	1.43

The endurance of capacitors is reduced with internal heating produced by ripple current at the rate of halving the lifetime with every 5°C rise. When long life performance is required in actual use, the rms ripple current has to be reduced.

Return Group Chart



LARGE CAPACITANCE ALUMINUM ELECTROLYTIC CAPACITORS

Standard snap-ins, 105°C

KMQ Series

- Endurance with ripple current : 2,000 hours at 105°C
- Non solvent resistant type
- RoHS Compliant



SPECIFICATIONS

Items	Characteristics														
Category	-40 to +105°C (35&50V _{dc}), -25 to +105°C (160 to 450V _{dc})														
Temperature Range															
Rated Voltage Range	35&50V _{dc} , 160 to 450V _{dc}														
Capacitance Tolerance	±20% (M) (at 20°C, 120Hz)														
Leakage Current	I ≤ 3√CV Where, I : Max. leakage current (μA), C : Nominal capacitance (μF), V : Rated voltage (V) (at 20°C after 5 minutes)														
Dissipation Factor (tan δ)	Rated voltage (V _{dc})	35V		50V		160 to 250V		315 to 400V		420 & 450V					
	Nominal capacitance (μF)	10,000 > C ≥ 10,000		10,000 > C ≥ 10,000		—		—		—					
	tan δ (Max.)	0.30		0.35		0.25		0.30		0.15		0.15		0.20	
Low Temperature Characteristics (Max. Impedance Ratio)	Rated voltage (V _{dc})	35&50V		160 to 250V		315 to 450V									
	Z(-25°C)/Z(+20°C)	4		4		8									
	Z(-40°C)/Z(+20°C)	10		—		—									
Endurance	The following specifications shall be satisfied when the capacitors are restored to 20°C after subjected to DC voltage with the rated ripple current is applied (the peak voltage shall not exceed the rated voltage) for 2,000 hours at 105°C.														
	Capacitance change	≤ ±20% of the initial value													
	D.F. (tan δ)	≤ 200% of the initial specified value													
	Leakage current	≤ The initial specified value													
Shelf Life	The following specifications shall be satisfied when the capacitors are restored to 20°C after exposing them for 1,000 hours at 105°C without voltage applied. Before the measurement, the capacitor shall be preconditioned by applying voltage according to Item 4.1 of JIS C 5101-4.														
	Capacitance change	≤ ±15% of the initial value													
	D.F. (tan δ)	≤ 150% of the initial specified value													
	Leakage current	≤ The initial specified value													

DIMENSIONS [mm]

Terminal Code : VS (φ22 to φ35) : Standard

Terminal Code : LI (φ35)

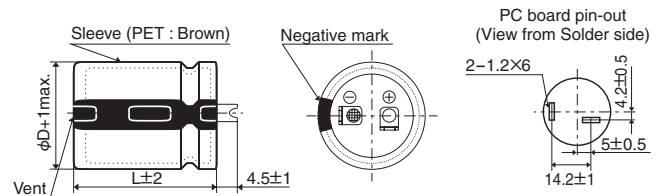
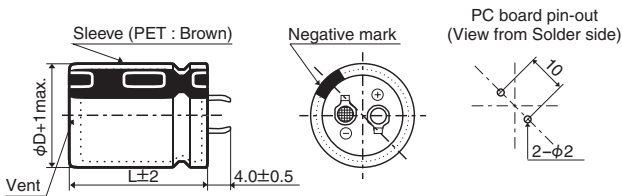

The standard design has no plastic disc.

PART NUMBERING SYSTEM

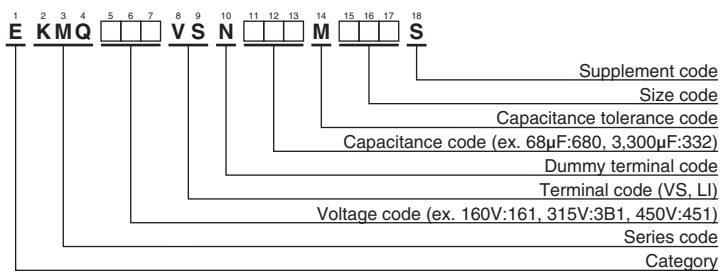

Please refer to "Product code guide (snap-in type)"

Return Group Chart



LARGE CAPACITANCE ALUMINUM ELECTROLYTIC CAPACITORS

Standard snap-ins, 105°C



STANDARD RATINGS

WV (V _{dc})	Cap (μF)	Case size φD×L(mm)	tan δ	Rated ripple current (Arms/ 105°C, 120Hz)	Part No.	WV (V _{dc})	Cap (μF)	Case size φD×L(mm)	tan δ	Rated ripple current (Arms/ 105°C, 120Hz)	Part No.	
35	4,700	22 × 25	0.30	1.87	EKMQ350VSN472MP25S	160	1,800	30 × 40	0.15	2.70	EKMQ161VSN182MR40S	
	5,600	22 × 25	0.30	2.04	EKMQ350VSN562MP25S		1,800	35 × 30	0.15	2.70	EKMQ161VSN182MA30S	
	5,600	25.4 × 25	0.30	2.00	EKMQ350VSN562MQ25S		2,200	30 × 45	0.15	2.90	EKMQ161VSN222MR45S	
	6,800	22 × 30	0.30	2.36	EKMQ350VSN682MP30S		2,200	35 × 35	0.15	2.90	EKMQ161VSN222MA35S	
	6,800	25.4 × 25	0.30	2.21	EKMQ350VSN682MQ25S		2,700	30 × 50	0.15	3.10	EKMQ161VSN272MR50S	
	8,200	22 × 35	0.30	2.65	EKMQ350VSN822MP35S		2,700	35 × 40	0.15	3.10	EKMQ161VSN272MA40S	
	8,200	25.4 × 30	0.30	2.49	EKMQ350VSN822MQ30S		3,300	35 × 50	0.15	3.30	EKMQ161VSN332MA50S	
	8,200	30 × 25	0.30	2.62	EKMQ350VSN822MR25S		180	390	22 × 25	0.15	1.30	EKMQ181VSN391MP25S
	10,000	22 × 40	0.35	3.00	EKMQ350VSN103MP40S			470	22 × 30	0.15	1.40	EKMQ181VSN471MP30S
	10,000	25.4 × 35	0.35	2.88	EKMQ350VSN103MQ35S			560	22 × 30	0.15	1.50	EKMQ181VSN561MP30S
	10,000	30 × 25	0.35	2.90	EKMQ350VSN103MQ25S			560	25.4 × 25	0.15	1.50	EKMQ181VSN102MR25S
	12,000	22 × 50	0.35	3.47	EKMQ350VSN123MP50S			680	22 × 35	0.15	1.70	EKMQ181VSN681MP35S
	12,000	25.4 × 35	0.35	3.15	EKMQ350VSN123MQ35S			680	25.4 × 30	0.15	1.70	EKMQ181VSN681MQ30S
	12,000	30 × 30	0.35	3.25	EKMQ350VSN123MR30S			820	22 × 40	0.15	2.00	EKMQ181VSN821MP40S
	12,000	35 × 25	0.35	3.20	EKMQ350VSN123MA25S			820	25.4 × 30	0.15	2.00	EKMQ181VSN102MR30S
	15,000	25.4 × 40	0.35	3.61	EKMQ350VSN153MQ40S			820	30 × 25	0.15	2.00	EKMQ181VSN821MR25S
	15,000	30 × 35	0.35	3.78	EKMQ350VSN153MR35S			1,000	22 × 45	0.15	2.20	EKMQ181VSN102MP45S
	15,000	35 × 25	0.35	3.60	EKMQ350VSN153MA25S		1,000	25.4 × 40	0.15	2.20	EKMQ181VSN102MQ40S	
	18,000	25.4 × 50	0.35	4.14	EKMQ350VSN183MQ50S	1,000	30 × 30	0.15	2.20	EKMQ181VSN102MR30S		
	18,000	30 × 40	0.35	4.30	EKMQ350VSN183MR40S	1,000	35 × 25	0.15	2.20	EKMQ181VSN102MA25S		
18,000	35 × 30	0.35	4.10	EKMQ350VSN183MA30S	1,200	25.4 × 45	0.15	2.30	EKMQ181VSN122MQ45S			
22,000	30 × 50	0.35	5.00	EKMQ350VSN223MR50S	1,200	30 × 35	0.15	2.30	EKMQ181VSN122MR35S			
22,000	35 × 35	0.35	4.64	EKMQ350VSN223MA35S	1,200	35 × 30	0.15	2.30	EKMQ181VSN122MA30S			
27,000	35 × 40	0.35	5.37	EKMQ350VSN273MA40S	1,500	25.4 × 50	0.15	2.50	EKMQ181VSN152MQ50S			
33,000	35 × 50	0.35	6.00	EKMQ350VSN333MA50S	1,500	30 × 40	0.15	2.50	EKMQ181VSN152MR40S			
50	2,700	22 × 25	0.25	1.65	EKMQ500VSN272MP25S	1,500	35 × 30	0.15	2.50	EKMQ181VSN152MA30S		
	3,300	22 × 30	0.25	1.92	EKMQ500VSN332MP30S	1,800	30 × 45	0.15	2.70	EKMQ181VSN102MR45S		
	3,300	25.4 × 25	0.25	1.76	EKMQ500VSN332MQ25S	1,800	35 × 35	0.15	2.70	EKMQ181VSN182MA35S		
	3,900	22 × 30	0.25	2.08	EKMQ500VSN392MP30S	2,200	30 × 50	0.15	2.90	EKMQ181VSN222MR50S		
	3,900	25.4 × 25	0.25	2.04	EKMQ500VSN392MQ25S	2,200	35 × 40	0.15	2.90	EKMQ181VSN222MA40S		
	4,700	22 × 35	0.25	2.43	EKMQ500VSN472MP35S	2,700	35 × 50	0.15	3.10	EKMQ181VSN272MA50S		
	4,700	25.4 × 30	0.25	2.50	EKMQ500VSN472MQ30S	200	390	22 × 25	0.15	1.31	EKMQ201VSN391MP25S	
	4,700	30 × 25	0.25	2.29	EKMQ500VSN472MR25S		470	22 × 30	0.15	1.45	EKMQ201VSN471MP30S	
	5,600	22 × 40	0.25	2.63	EKMQ500VSN562MP40S		560	22 × 30	0.15	1.67	EKMQ201VSN561MP30S	
	5,600	25.4 × 35	0.25	2.61	EKMQ500VSN562MQ35S		560	25.4 × 25	0.15	1.67	EKMQ201VSN561MQ25S	
	5,600	30 × 25	0.25	2.80	EKMQ500VSN562MR25S		680	22 × 40	0.15	1.75	EKMQ201VSN681MP40S	
	6,800	22 × 50	0.25	3.05	EKMQ500VSN682MP50S		680	25.4 × 30	0.15	1.75	EKMQ201VSN681MQ30S	
	6,800	25.4 × 40	0.25	2.94	EKMQ500VSN682MQ40S		820	22 × 45	0.15	2.04	EKMQ201VSN821MP45S	
	6,800	30 × 30	0.25	3.30	EKMQ500VSN682MR30S		820	25.4 × 35	0.15	2.04	EKMQ201VSN821MQ35S	
	6,800	35 × 25	0.25	2.77	EKMQ500VSN682MA25S		820	30 × 25	0.15	2.04	EKMQ201VSN821MR25S	
	8,200	25.4 × 45	0.25	3.60	EKMQ500VSN822MQ45S		1,000	22 × 50	0.15	2.30	EKMQ201VSN102MP50S	
	8,200	30 × 35	0.25	3.60	EKMQ500VSN822MR35S	1,000	25.4 × 45	0.15	2.30	EKMQ201VSN102MQ45S		
	8,200	35 × 30	0.25	3.60	EKMQ500VSN822MA30S	1,000	30 × 30	0.15	2.30	EKMQ201VSN102MR30S		
	10,000	25.4 × 50	0.30	4.00	EKMQ500VSN103MQ50S	1,000	35 × 25	0.15	2.30	EKMQ201VSN102MA25S		
	10,000	30 × 40	0.30	4.00	EKMQ500VSN103MR40S	1,200	25.4 × 50	0.15	2.65	EKMQ201VSN122MQ50S		
10,000	35 × 30	0.30	4.00	EKMQ500VSN103MA30S	1,200	30 × 35	0.15	2.65	EKMQ201VSN122MR35S			
12,000	30 × 50	0.30	4.29	EKMQ500VSN123MR50S	1,200	35 × 30	0.15	2.65	EKMQ201VSN122MA30S			
12,000	35 × 35	0.30	4.37	EKMQ500VSN123MA35S	1,500	30 × 40	0.15	2.80	EKMQ201VSN152MR40S			
15,000	35 × 40	0.30	4.50	EKMQ500VSN153MA40S	1,500	35 × 30	0.15	2.80	EKMQ201VSN152MA30S			
18,000	35 × 50	0.30	5.30	EKMQ500VSN183MA50S	1,800	30 × 45	0.15	3.08	EKMQ201VSN182MR45S			
160	470	22 × 25	0.15	1.40	EKMQ161VSN471MP25S	1,800	35 × 40	0.15	3.08	EKMQ201VSN182MA40S		
	560	22 × 30	0.15	1.50	EKMQ161VSN561MP30S	2,200	35 × 45	0.15	3.48	EKMQ201VSN222MA45S		
	680	22 × 30	0.15	1.70	EKMQ161VSN681MP30S	250	220	22 × 25	0.15	1.00	EKMQ251VSN221MP25S	
	680	25.4 × 25	0.15	1.70	EKMQ161VSN681MQ25S		270	22 × 25	0.15	1.10	EKMQ251VSN271MP25S	
	820	22 × 35	0.15	2.00	EKMQ161VSN821MP35S		330	22 × 30	0.15	1.20	EKMQ251VSN331MP30S	
	820	25.4 × 30	0.15	2.00	EKMQ161VSN821MQ30S		330	25.4 × 25	0.15	1.20	EKMQ251VSN331MQ25S	
	820	30 × 25	0.15	2.00	EKMQ161VSN821MR25S		390	22 × 35	0.15	1.30	EKMQ251VSN391MP35S	
	1,000	22 × 40	0.15	2.20	EKMQ161VSN102MP40S		390	25.4 × 25	0.15	1.30	EKMQ251VSN391MQ25S	
	1,000	25.4 × 35	0.15	2.20	EKMQ161VSN102MQ35S		470	22 × 40	0.15	1.40	EKMQ251VSN471MP40S	
	1,000	30 × 25	0.15	2.20	EKMQ161VSN102MR25S		470	25.4 × 30	0.15	1.40	EKMQ251VSN471MQ30S	
	1,200	25.4 × 40	0.15	2.30	EKMQ161VSN122MQ40S		470	30 × 25	0.15	1.40	EKMQ251VSN471MR25S	
	1,200	30 × 30	0.15	2.30	EKMQ161VSN122MR30S		560	22 × 45	0.15	1.50	EKMQ251VSN561MP45S	
	1,200	35 × 25	0.15	2.30	EKMQ161VSN122MA25S	560	25.4 × 35	0.15	1.50	EKMQ251VSN561MQ35S		
	1,500	25.4 × 45	0.15	2.50	EKMQ161VSN152MQ45S	560	30 × 25	0.15	1.50	EKMQ251VSN561MR25S		
	1,500	30 × 35	0.15	2.50	EKMQ161VSN152MR35S	680	22 × 50	0.15	1.70	EKMQ251VSN681MP50S		
	1,500	35 × 30	0.15	2.50	EKMQ161VSN152MA30S	680	25.4 × 40	0.15	1.70	EKMQ251VSN681MQ40S		
	1,800	25.4 × 50	0.15	2.70	EKMQ161VSN182MQ50S	680	30 × 30	0.15	1.70	EKMQ251VSN681MR30S		

Product specifications in this catalog are subject to change without notice. Request our product specifications before purchase and/or use. Please use our products based on the information contained in this catalog and product specifications.



◆ STANDARD RATINGS

WV (V _{dc})	Cap (μF)	Case size φD×L(mm)	tan δ	Rated ripple current (Arms/105°C, 120Hz)	Part No.	WV (V _{dc})	Cap (μF)	Case size φD×L(mm)	tan δ	Rated ripple current (Arms/105°C, 120Hz)	Part No.
250	680	35 × 25	0.15	1.70	EKMQ251VSN681MA25S	400	270	25.4 × 40	0.15	1.22	EKMQ401VSN271MQ40S
	820	25.4 × 45	0.15	2.00	EKMQ251VSN821MQ45S		270	30 × 30	0.15	1.22	EKMQ401VSN271MR30S
	820	30 × 35	0.15	2.00	EKMQ251VSN821MR35S		270	35 × 25	0.15	1.22	EKMQ401VSN271MA25S
	820	35 × 30	0.15	2.00	EKMQ251VSN821MA30S		330	25.4 × 45	0.15	1.44	EKMQ401VSN331MQ45S
	1,000	30 × 40	0.15	2.20	EKMQ251VSN102MR40S		330	30 × 35	0.15	1.44	EKMQ401VSN331MR35S
	1,000	35 × 30	0.15	2.20	EKMQ251VSN102MA30S		330	35 × 30	0.15	1.44	EKMQ401VSN331MA30S
	1,200	30 × 45	0.15	2.30	EKMQ251VSN122MR45S		390	25.4 × 50	0.15	1.55	EKMQ401VSN391MQ50S
	1,200	35 × 35	0.15	2.30	EKMQ251VSN122MA35S		390	30 × 40	0.15	1.55	EKMQ401VSN391MR40S
	1,500	35 × 45	0.15	2.50	EKMQ251VSN152MA45S		390	35 × 30	0.15	1.55	EKMQ401VSN391MA30S
1,800	35 × 50	0.15	2.70	EKMQ251VSN182MA50S	470	30 × 45	0.15	1.68	EKMQ401VSN471MR45S		
315	150	22 × 25	0.15	0.82	EKMQ3B1VSN151MP25S	470	35 × 35	0.15	1.68	EKMQ401VSN471MA35S	
	180	22 × 30	0.15	0.90	EKMQ3B1VSN181MP30S	560	30 × 50	0.15	1.90	EKMQ401VSN561MR50S	
	220	22 × 30	0.15	1.00	EKMQ3B1VSN221MP30S	560	35 × 40	0.15	1.90	EKMQ401VSN561MA40S	
	220	25.4 × 25	0.15	1.00	EKMQ3B1VSN221MQ25S	680	35 × 45	0.15	2.12	EKMQ401VSN681MA45S	
	270	22 × 35	0.15	1.10	EKMQ3B1VSN271MP35S	82	22 × 25	0.20	0.64	EKMQ421VSN820MP25S	
	270	25.4 × 30	0.15	1.10	EKMQ3B1VSN271MQ30S	100	22 × 25	0.20	0.66	EKMQ421VSN101MP25S	
	330	22 × 45	0.15	1.20	EKMQ3B1VSN331MP45S	100	25.4 × 25	0.20	0.66	EKMQ421VSN101MQ25S	
	330	25.4 × 35	0.15	1.20	EKMQ3B1VSN331MQ35S	120	22 × 30	0.20	0.81	EKMQ421VSN121MP30S	
	330	30 × 25	0.15	1.20	EKMQ3B1VSN331MR25S	120	25.4 × 25	0.20	0.81	EKMQ421VSN121MQ25S	
	390	22 × 45	0.15	1.30	EKMQ3B1VSN391MP45S	150	22 × 35	0.20	0.84	EKMQ421VSN151MP35S	
	390	25.4 × 40	0.15	1.30	EKMQ3B1VSN391MQ40S	150	25.4 × 30	0.20	0.84	EKMQ421VSN151MQ30S	
	390	30 × 30	0.15	1.30	EKMQ3B1VSN391MR30S	150	30 × 25	0.20	0.84	EKMQ421VSN151MR25S	
	390	35 × 25	0.15	1.30	EKMQ3B1VSN391MA25S	180	22 × 40	0.20	0.91	EKMQ421VSN181MP40S	
	470	25.4 × 45	0.15	1.40	EKMQ3B1VSN471MQ45S	180	25.4 × 30	0.20	0.91	EKMQ421VSN181MQ30S	
	470	30 × 35	0.15	1.40	EKMQ3B1VSN471MR35S	180	30 × 25	0.20	0.91	EKMQ421VSN181MR25S	
	470	35 × 25	0.15	1.40	EKMQ3B1VSN471MA25S	220	22 × 45	0.20	1.05	EKMQ421VSN221MP45S	
	560	25.4 × 50	0.15	1.50	EKMQ3B1VSN561MQ50S	220	25.4 × 35	0.20	1.05	EKMQ421VSN221MQ35S	
	560	30 × 40	0.15	1.50	EKMQ3B1VSN561MR40S	220	30 × 30	0.20	1.05	EKMQ421VSN221MR30S	
	560	35 × 30	0.15	1.50	EKMQ3B1VSN561MA30S	220	35 × 25	0.20	1.05	EKMQ421VSN221MA25S	
	680	30 × 45	0.15	1.70	EKMQ3B1VSN681MR45S	270	25.4 × 40	0.20	1.25	EKMQ421VSN271MQ40S	
	680	35 × 35	0.15	1.70	EKMQ3B1VSN681MA35S	270	30 × 30	0.20	1.25	EKMQ421VSN271MR30S	
820	30 × 50	0.15	2.00	EKMQ3B1VSN821MR50S	270	35 × 25	0.20	1.25	EKMQ421VSN271MA25S		
820	35 × 40	0.15	2.00	EKMQ3B1VSN821MA40S	330	25.4 × 50	0.20	1.42	EKMQ421VSN331MQ50S		
1,000	35 × 45	0.15	2.30	EKMQ3B1VSN102MA45S	330	30 × 35	0.20	1.42	EKMQ421VSN331MR35S		
350	120	22 × 25	0.15	0.75	EKMQ351VSN121MP25S	330	35 × 30	0.20	1.42	EKMQ421VSN331MA30S	
	150	22 × 30	0.15	0.82	EKMQ351VSN151MP30S	390	30 × 40	0.20	1.61	EKMQ421VSN391MR40S	
	180	22 × 30	0.15	0.90	EKMQ351VSN181MP30S	390	35 × 35	0.20	1.61	EKMQ421VSN391MA35S	
	180	25.4 × 25	0.15	0.90	EKMQ351VSN181MQ25S	470	30 × 45	0.20	1.86	EKMQ421VSN471MR45S	
	220	22 × 35	0.15	1.00	EKMQ351VSN221MP35S	470	35 × 40	0.20	1.86	EKMQ421VSN471MA40S	
	220	25.4 × 30	0.15	1.00	EKMQ351VSN221MQ30S	560	35 × 45	0.20	2.10	EKMQ421VSN561MA45S	
	270	22 × 40	0.15	1.10	EKMQ351VSN271MP40S	680	35 × 50	0.20	2.20	EKMQ421VSN681MA50S	
	270	25.4 × 30	0.15	1.10	EKMQ351VSN271MQ30S	68	22 × 25	0.20	0.50	EKMQ451VSN680MP25S	
	270	30 × 25	0.15	1.10	EKMQ351VSN271MR25S	82	22 × 30	0.20	0.56	EKMQ451VSN820MP30S	
	330	22 × 45	0.15	1.20	EKMQ351VSN331MP45S	100	22 × 30	0.20	0.64	EKMQ451VSN101MP30S	
	330	25.4 × 40	0.15	1.20	EKMQ351VSN331MQ40S	100	25.4 × 25	0.20	0.64	EKMQ451VSN101MQ25S	
	330	30 × 30	0.15	1.20	EKMQ351VSN331MR30S	120	22 × 35	0.20	0.72	EKMQ451VSN121MP35S	
	390	25.4 × 45	0.15	1.30	EKMQ351VSN391MQ45S	120	25.4 × 30	0.20	0.72	EKMQ451VSN121MQ30S	
	390	30 × 35	0.15	1.30	EKMQ351VSN391MR35S	150	22 × 40	0.20	0.79	EKMQ451VSN151MP40S	
	470	25.4 × 50	0.15	1.40	EKMQ351VSN471MQ50S	150	25.4 × 30	0.20	0.79	EKMQ451VSN151MQ30S	
	470	30 × 35	0.15	1.40	EKMQ351VSN471MR35S	150	30 × 25	0.20	0.79	EKMQ451VSN151MR25S	
	470	35 × 30	0.15	1.40	EKMQ351VSN471MA30S	180	22 × 45	0.20	0.87	EKMQ451VSN181MP45S	
	560	30 × 45	0.15	1.50	EKMQ351VSN561MR45S	180	25.4 × 40	0.20	0.87	EKMQ451VSN181MQ40S	
	560	35 × 35	0.15	1.50	EKMQ351VSN561MA35S	180	30 × 30	0.20	0.87	EKMQ451VSN181MR30S	
	680	30 × 50	0.15	1.70	EKMQ351VSN681MR50S	220	25.4 × 45	0.20	1.00	EKMQ451VSN221MQ45S	
	680	35 × 40	0.15	1.70	EKMQ351VSN681MA40S	220	30 × 30	0.20	1.00	EKMQ451VSN221MR30S	
820	35 × 45	0.15	1.90	EKMQ351VSN821MA45S	220	35 × 25	0.20	1.00	EKMQ451VSN221MA25S		
100	22 × 25	0.15	0.70	EKMQ401VSN101MP25S	270	25.4 × 50	0.20	1.19	EKMQ451VSN271MQ50S		
120	22 × 30	0.15	0.75	EKMQ401VSN121MP30S	270	30 × 40	0.20	1.19	EKMQ451VSN271MR40S		
150	22 × 30	0.15	0.88	EKMQ401VSN151MP30S	270	35 × 30	0.20	1.19	EKMQ451VSN271MA30S		
150	25.4 × 25	0.15	0.88	EKMQ401VSN151MQ25S	330	30 × 45	0.20	1.38	EKMQ451VSN331MQ45S		
180	22 × 35	0.15	0.95	EKMQ401VSN181MP35S	330	35 × 35	0.20	1.38	EKMQ451VSN331MA35S		
180	25.4 × 30	0.15	0.95	EKMQ401VSN181MQ30S	390	30 × 50	0.20	1.55	EKMQ451VSN391MR50S		
220	22 × 45	0.15	1.10	EKMQ401VSN221MP45S	390	35 × 40	0.20	1.55	EKMQ451VSN391MA40S		
220	25.4 × 35	0.15	1.10	EKMQ401VSN221MQ35S	470	35 × 45	0.20	1.74	EKMQ451VSN471MA45S		
220	30 × 25	0.15	1.10	EKMQ401VSN221MR25S	560	35 × 50	0.20	1.90	EKMQ451VSN561MA50S		
270	22 × 50	0.15	1.22	EKMQ401VSN271MP50S							

Product specifications in this catalog are subject to change without notice. Request our product specifications before purchase and/or use. Please use our products based on the information contained in this catalog and product specifications.



KMQ Series

◆ RATED RIPPLE CURRENT MULTIPLIERS

● Frequency Multipliers

Frequency(Hz)	50	120	300	1k	10k	50k
35, 50V_{dc}	0.95	1.00	1.03	1.05	1.08	1.08
160 to 250V_{dc}	0.81	1.00	1.17	1.32	1.45	1.50
315 to 450V_{dc}	0.77	1.00	1.16	1.30	1.41	1.43

The endurance of capacitors is reduced with internal heating produced by ripple current at the rate of halving the lifetime with every 5°C rise. When long life performance is required in actual use, the rms ripple current has to be reduced.

Return Group Chart



LARGE CAPACITANCE ALUMINUM ELECTROLYTIC CAPACITORS

High ripple snap-ins, 85°C

RLB Series New!

- Endurance with ripple current : 5,000 hours at 85°C
- High ripple current capability in a commercial frequency range
- High ripple current for inverter control like air conditioner
- Rated voltage range : 180 to 250Vdc, Capacitance range : 600 to 2,200μF
- Non solvent resistant type
- RoHS Compliant

RLB
↑
Longer life
RLA P249



◆ SPECIFICATIONS

Items	Characteristics	
Category	-25 to +85°C	
Temperature Range	-25 to +85°C	
Rated Voltage Range	180 to 250V	
Capacitance Tolerance	± 10% (K) (at 20°C, 120Hz)	
Leakage Current	$I \leq 3/CV$ Where, I : Max. leakage current (μA), C : Nominal capacitance (μF), V : Rated voltage (V) (at 20°C after 5 minutes)	
Dissipation Factor (tan δ)	Rated voltage (V _{ac})	180 to 250V
	tan δ (Max.)	0.15 (at 20°C, 120Hz)
Low Temperature Characteristics (Max. Impedance Ratio)	Rated voltage (V _{ac})	180 to 250V
	Z(-25°C)/Z(+20°C)	4 (at 120Hz)
Endurance	The following specifications shall be satisfied when the capacitors are restored to 20°C after subjected to DC voltage with the rated ripple current is applied (the peak voltage shall not exceed the rated voltage) for 5,000 hours at 85°C.	
	Capacitance change	≤ ±20% of the initial value
	D. F. (tan δ)	≤ 200% of the initial specified value
	Leakage current	≤ The initial specified value
Shelf Life	The following specifications shall be satisfied when the capacitors are restored to 20°C after exposing them for 1,000 hours at 85°C without voltage applied. Before the measurement, the capacitor shall be preconditioned by applying voltage according to Item 4.1 of JIS C 5101-4.	
	Capacitance change	≤ ± 15% of the initial value
	D. F. (tan δ)	≤ 150% of the initial specified value
	Leakage current	≤ The initial specified value

◆ DIMENSIONS [mm]

● Terminal Code : LI (φ30, φ35) : Standard

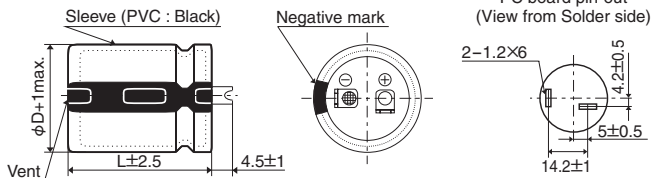

● Terminal Code : VS (φ30, φ35)

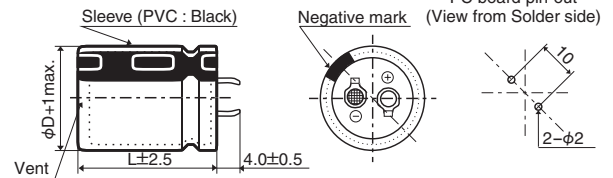

The standard design has no plastic disc.

◆ PART NUMBERING SYSTEM

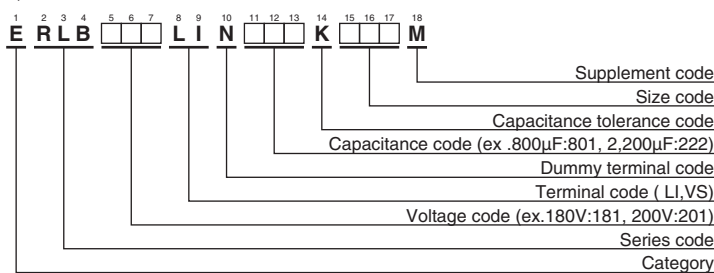

Please refer to "Product code guide (snap-in type)"

Return Group Chart



LARGE CAPACITANCE ALUMINUM ELECTROLYTIC CAPACITORS

High ripple snap-ins, 85°C



◆STANDARD RATINGS

WV (V _{dc})	Cap (μF)	Case size φD×L(mm)	tan δ	Rated ripple current (Arms/85°C, 120Hz)	Part No.	WV (V _{dc})	Cap (μF)	Case size φD×L(mm)	tan δ	Rated ripple current (Arms/85°C, 120Hz)	Part No.
180	900	30 × 35	0.15	4.66	ERLB181LIN901KR35M	210	1,400	30 × 55	0.15	6.31	ERLB211LIN142KR55M
	1,100	30 × 40	0.15	5.17	ERLB181LIN112KR40M		1,500	35 × 45	0.15	6.21	ERLB211LIN152KA45M
	1,300	30 × 45	0.15	5.64	ERLB181LIN132KR45M		1,700	35 × 50	0.15	6.82	ERLB211LIN172KA50M
	1,500	30 × 50	0.15	6.07	ERLB181LIN152KR50M		2,000	35 × 55	0.15	7.62	ERLB211LIN202KA55M
	1,500	35 × 40	0.15	5.75	ERLB181LIN152KA40M	220	700	30 × 35	0.15	4.27	ERLB221LIN701KR35M
	1,700	30 × 55	0.15	6.63	ERLB181LIN172KR55M		900	30 × 40	0.15	4.85	ERLB221LIN901KR40M
	1,800	35 × 45	0.15	6.37	ERLB181LIN182KA45M		1,000	30 × 45	0.15	5.19	ERLB221LIN102KR45M
	2,000	35 × 50	0.15	6.84	ERLB181LIN202KA50M		1,000	35 × 35	0.15	4.87	ERLB221LIN102KA35M
200	900	30 × 35	0.15	4.66	ERLB201LIN901KR35M		1,200	30 × 50	0.15	5.68	ERLB221LIN122KR50M
	1,000	30 × 40	0.15	5.01	ERLB201LIN102KR40M		1,200	35 × 40	0.15	5.44	ERLB221LIN122KA40M
	1,200	30 × 45	0.15	5.51	ERLB201LIN122KR45M		1,300	30 × 55	0.15	6.09	ERLB221LIN132KR55M
	1,200	35 × 35	0.15	5.14	ERLB201LIN122KA35M		1,400	35 × 45	0.15	5.96	ERLB221LIN142KA45M
	1,400	30 × 50	0.15	5.95	ERLB201LIN142KR50M	1,600	35 × 50	0.15	6.51	ERLB221LIN162KA50M	
	1,400	35 × 40	0.15	5.66	ERLB201LIN142KA40M	1,800	35 × 55	0.15	7.10	ERLB221LIN182KA55M	
	1,500	30 × 55	0.15	6.36	ERLB201LIN152KR55M	250	600	30 × 35	0.15	4.03	ERLB251LIN601KR35M
	1,600	35 × 45	0.15	6.14	ERLB201LIN162KA45M		800	30 × 40	0.15	4.66	ERLB251LIN801KR40M
1,900	35 × 50	0.15	6.82	ERLB201LIN192KA50M	900		30 × 45	0.15	5.01	ERLB251LIN901KR45M	
2,200	35 × 55	0.15	7.60	ERLB201LIN222KA55M	900		35 × 35	0.15	4.73	ERLB251LIN901KA35M	
210	800	30 × 35	0.15	4.48	ERLB211LIN801KR35M		1,000	30 × 50	0.15	5.32	ERLB251LIN102KR50M
	900	30 × 40	0.15	4.86	ERLB211LIN901KR40M		1,100	35 × 40	0.15	5.33	ERLB251LIN112KA40M
	1,100	30 × 45	0.15	5.39	ERLB211LIN112KR45M		1,200	30 × 55	0.15	5.96	ERLB251LIN122KR55M
	1,100	35 × 35	0.15	5.06	ERLB211LIN112KA35M		1,200	35 × 45	0.15	5.68	ERLB251LIN122KA45M
	1,200	30 × 50	0.15	5.71	ERLB211LIN122KR50M	1,400	35 × 50	0.15	6.25	ERLB251LIN142KA50M	
	1,300	35 × 40	0.15	5.65	ERLB211LIN132KA40M	1,600	35 × 55	0.15	6.87	ERLB251LIN162KA55M	

◆RATED RIPPLE CURRENT MULTIPLIERS

●Frequency Multipliers

Frequency(Hz)	50	120	300	1k	10k	50k
180 to 250V _{dc}	0.70	1.00	1.17	1.32	1.45	1.50

The endurance of capacitors is reduced with internal heating produced by ripple current at the rate of halving the lifetime with every 5°C rise. When long life performance is required in actual use, the rms ripple current has to be reduced.



RLA Series

- Endurance with ripple current : 3,000 hours at 85°C
- High ripple current capability in a commercial frequency range
- High ripple current for inverter control like air conditioner
- Rated voltage range : 180 to 250Vdc, Capacitance range : 600 to 2,200μF
- Non solvent resistant type
- RoHS Compliant

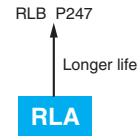

◆ SPECIFICATIONS

Items	Characteristics		
Category Temperature Range	-25 to +85°C		
Rated Voltage Range	180 to 250V		
Capacitance Tolerance	± 10% (K) (at 20°C, 120Hz)		
Leakage Current	I ≤ 3/CV Where, I : Max. leakage current (μA), C : Nominal capacitance (μF), V : Rated voltage (V) (at 20°C after 5 minutes)		
Dissipation Factor (tan δ)	Rated voltage (V _{ac})	180 to 250V	(at 20°C, 120Hz)
	tan δ (Max.)	0.15	
Low Temperature Characteristics (Max. Impedance Ratio)	Rated voltage (V _{ac})	180 to 250V	(at 120Hz)
	Z(-25°C)/Z(+20°C)	4	
Endurance	The following specifications shall be satisfied when the capacitors are restored to 20°C after subjected to DC voltage with the rated ripple current is applied (the peak voltage shall not exceed the rated voltage) for 3,000 hours at 85°C.		
	Capacitance change	≤ ±20% of the initial value	
	D. F. (tan δ)	≤ 200% of the initial specified value	
	Leakage current	≤ The initial specified value	
Shelf Life	The following specifications shall be satisfied when the capacitors are restored to 20°C after exposing them for 1,000 hours at 85°C without voltage applied. Before the measurement, the capacitor shall be preconditioned by applying voltage according to Item 4.1 of JIS C 5101-4.		
	Capacitance change	≤ ± 15% of the initial value	
	D. F. (tan δ)	≤ 150% of the initial specified value	
	Leakage current	≤ The initial specified value	

◆ DIMENSIONS [mm]

● Terminal Code : LI (φ30, φ35) : Standard

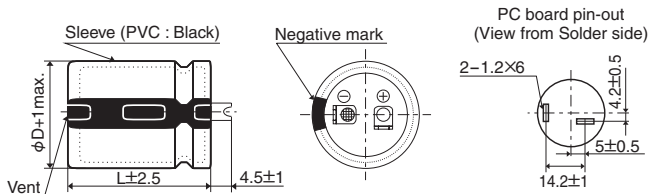

● Terminal Code : VS (φ30, φ35)

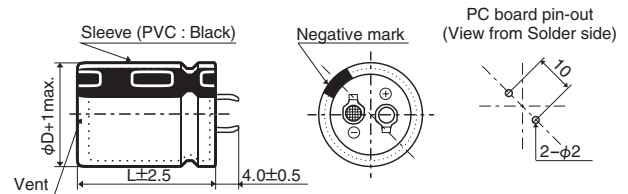

The standard design has no plastic disc.

◆ PART NUMBERING SYSTEM

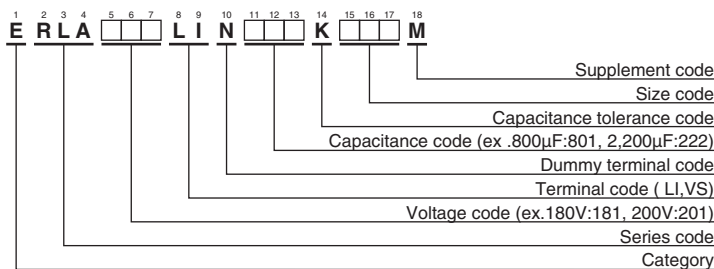

Please refer to "Product code guide (snap-in type)"

Return Group Chart



LARGE CAPACITANCE ALUMINUM ELECTROLYTIC CAPACITORS

High ripple snap-ins, 85°C

RLASeries

◆STANDARD RATINGS

WV (V _{dc})	Cap (μF)	Case size φD×L(mm)	tan δ	Rated ripple current (Arms/85°C, 120Hz)	Part No.	WV (V _{dc})	Cap (μF)	Case size φD×L(mm)	tan δ	Rated ripple current (Arms/85°C, 120Hz)	Part No.	
180	900	30 × 35	0.15	4.66	ERLA181LIN901KR35M	210	1,400	30 × 55	0.15	6.31	ERLA211LIN142KR55M	
	1,100	30 × 40	0.15	5.17	ERLA181LIN112KR40M		1,500	35 × 45	0.15	6.21	ERLA211LIN152KA45M	
	1,300	30 × 45	0.15	5.64	ERLA181LIN132KR45M		1,700	35 × 50	0.15	6.82	ERLA211LIN172KA50M	
	1,500	30 × 50	0.15	6.07	ERLA181LIN152KR50M		2,000	35 × 55	0.15	7.62	ERLA211LIN202KA55M	
	200	1,500	35 × 40	0.15	5.75	ERLA181LIN152KA40M	220	700	30 × 35	0.15	4.27	ERLA221LIN701KR35M
		1,700	30 × 55	0.15	6.63	ERLA181LIN172KR55M		900	30 × 40	0.15	4.85	ERLA221LIN901KR40M
		1,800	35 × 45	0.15	6.37	ERLA181LIN182KA45M		1,000	30 × 45	0.15	5.19	ERLA221LIN102KR45M
		2,000	35 × 50	0.15	6.84	ERLA181LIN202KA50M		1,000	35 × 35	0.15	4.87	ERLA221LIN102KA35M
210		900	30 × 35	0.15	4.66	ERLA201LIN901KR35M		1,200	30 × 50	0.15	5.68	ERLA221LIN122KR50M
		1,000	30 × 40	0.15	5.01	ERLA201LIN102KR40M		1,200	35 × 40	0.15	5.44	ERLA221LIN122KA40M
		1,200	30 × 45	0.15	5.51	ERLA201LIN122KR45M		1,300	30 × 55	0.15	6.09	ERLA221LIN132KR55M
		1,200	35 × 35	0.15	5.14	ERLA201LIN122KA35M		1,400	35 × 45	0.15	5.96	ERLA221LIN142KA45M
		1,400	30 × 50	0.15	5.95	ERLA201LIN142KR50M		1,600	35 × 50	0.15	6.51	ERLA221LIN162KA50M
		1,400	35 × 40	0.15	5.66	ERLA201LIN142KA40M		1,800	35 × 55	0.15	7.10	ERLA221LIN182KA55M
	1,500	30 × 55	0.15	6.36	ERLA201LIN152KR55M	250	600	30 × 35	0.15	4.03	ERLA251LIN601KR35M	
	1,600	35 × 45	0.15	6.14	ERLA201LIN162KA45M		800	30 × 40	0.15	4.66	ERLA251LIN801KR40M	
1,900	35 × 50	0.15	6.82	ERLA201LIN192KA50M	900		30 × 45	0.15	5.01	ERLA251LIN901KR45M		
2,200	35 × 55	0.15	7.60	ERLA201LIN222KA55M	900		35 × 35	0.15	4.73	ERLA251LIN901KA35M		
210	800	30 × 35	0.15	4.48	ERLA211LIN801KR35M		1,000	30 × 50	0.15	5.32	ERLA251LIN102KR50M	
	900	30 × 40	0.15	4.86	ERLA211LIN901KR40M		1,100	35 × 40	0.15	5.33	ERLA251LIN112KA40M	
	1,100	30 × 45	0.15	5.39	ERLA211LIN112KR45M		1,200	30 × 55	0.15	5.96	ERLA251LIN122KR55M	
	1,100	35 × 35	0.15	5.06	ERLA211LIN112KA35M		1,200	35 × 45	0.15	5.68	ERLA251LIN122KA45M	
	1,200	30 × 50	0.15	5.71	ERLA211LIN122KR50M	1,400	35 × 50	0.15	6.25	ERLA251LIN142KA50M		
	1,300	35 × 40	0.15	5.65	ERLA211LIN132KA40M	1,600	35 × 55	0.15	6.87	ERLA251LIN162KA55M		

◆RATED RIPPLE CURRENT MULTIPLIERS

●Frequency Multipliers

Frequency(Hz)	50	120	300	1k	10k	50k
180 to 250V _{dc}	0.70	1.00	1.17	1.32	1.45	1.50

The endurance of capacitors is reduced with internal heating produced by ripple current at the rate of halving the lifetime with every 5°C rise. When long life performance is required in actual use, the rms ripple current has to be reduced.

Return Group Chart



LARGE CAPACITANCE ALUMINUM ELECTROLYTIC CAPACITORS

Long life snap-ins, 85°C

SMM Series

- Longer life from SMQ series
- Endurance with ripple current : 3,000 hours at 85°C
- Non solvent resistant type
- RoHS Compliant

SMM

↑ Longer life
SMQ P233



◆ SPECIFICATIONS

Items	Characteristics		
Category	-25 to +85°C		
Temperature Range	-25 to +85°C		
Rated Voltage Range	160 to 450V _{dc}		
Capacitance Tolerance	±20% (M) (at 20°C, 120Hz)		
Leakage Current	I ≤ 3/√CV Where, I : Max. leakage current (μA), C : Nominal capacitance (μF), V : Rated voltage (V) (at 20°C after 5 minutes)		
Dissipation Factor (tan δ)	Rated voltage (V _{dc})	160 to 400V	420 & 450V
	tan δ (Max.)	0.15	0.20
Low Temperature Characteristics (Max. Impedance Ratio)	Rated voltage (V _{dc})	160 to 400V	420 & 450V
	Z(-25°C)/Z(+20°C)	4	8
Endurance	The following specifications shall be satisfied when the capacitors are restored to 20°C after subjected to DC voltage with the rated ripple current is applied (the peak voltage shall not exceed the rated voltage) for 3,000 hours at 85°C.		
	Capacitance change	≤ ±20% of the initial value	
	D.F. (tan δ)	≤ 200% of the initial specified value	
	Leakage current	≤ The initial specified value	
Shelf Life	The following specifications shall be satisfied when the capacitors are restored to 20°C after exposing them for 1,000 hours at 85°C without voltage applied. Before the measurement, the capacitor shall be preconditioned by applying voltage according to Item 4.1 of JIS C 5101-4.		
	Capacitance change	≤ ±15% of the initial value	
	D.F. (tan δ)	≤ 150% of the initial specified value	
	Leakage current	≤ The initial specified value	

◆ DIMENSIONS [mm]

● Terminal Code : VS (φ22 to φ35) : Standard

● Terminal Code : LI (φ35)

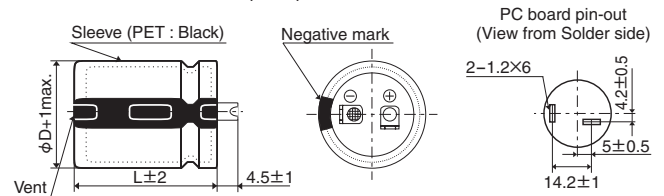
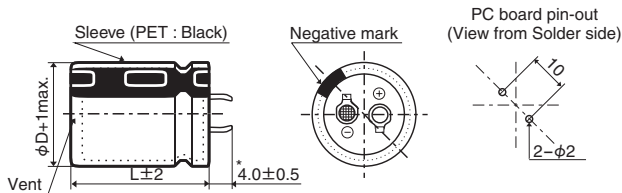

* φD=35mm : 3.5±0.5mm

The standard design has no plastic disc.

◆ PART NUMBERING SYSTEM

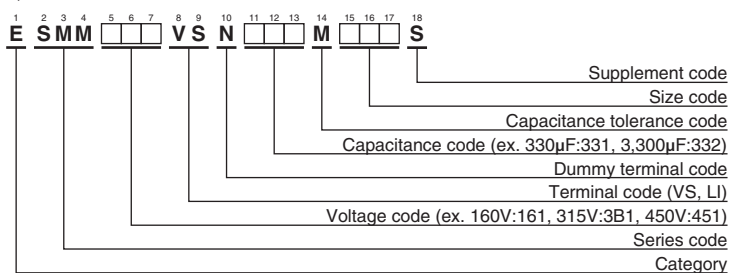

Please refer to "Product code guide (snap-in type)"

◆ RATED RIPPLE CURRENT MULTIPLIERS

● Frequency Multipliers

Frequency(Hz)	50	120	300	1k	10k	50k
160 to 250V _{dc}	0.81	1.00	1.17	1.32	1.45	1.50
315 to 450V _{dc}	0.77	1.00	1.16	1.30	1.41	1.43

The endurance of capacitors is reduced with internal heating produced by ripple current at the rate of halving the lifetime with every 5°C rise. When long life performance is required in actual use, the rms ripple current has to be reduced.

Return Group Chart



LARGE CAPACITANCE ALUMINUM ELECTROLYTIC CAPACITORS

Long life snap-ins, 85°C

SMMSeries

◆STANDARD RATINGS

WV (V _{dc})	Cap (μF)	Case size φD×L(mm)	tan δ	Rated ripple current (Arms/85°C, 120Hz)	Part No.	WV (V _{dc})	Cap (μF)	Case size φD×L(mm)	tan δ	Rated ripple current (Arms/85°C, 120Hz)	Part No.
160	270	22 × 20	0.15	1.30	ESMM161VSN271MP20S	200	390	22 × 30	0.15	1.73	ESMM201VSN391MP30S
	390	22 × 25	0.15	1.63	ESMM161VSN391MP25S		390	25.4 × 25	0.15	1.71	ESMM201VSN391MQ25S
	390	25.4 × 20	0.15	1.62	ESMM161VSN391MQ20S		390	30 × 20	0.15	1.71	ESMM201VSN391MR20S
	470	22 × 30	0.15	1.86	ESMM161VSN471MP30S		470	22 × 30	0.15	1.97	ESMM201VSN471MP30S
	470	25.4 × 25	0.15	1.86	ESMM161VSN471MQ25S		470	25.4 × 25	0.15	1.95	ESMM201VSN471MQ25S
	560	22 × 30	0.15	2.15	ESMM161VSN561MP30S		470	30 × 20	0.15	1.88	ESMM201VSN471MR20S
	560	25.4 × 25	0.15	2.15	ESMM161VSN561MQ25S		560	22 × 35	0.15	2.18	ESMM201VSN561MP35S
	560	30 × 20	0.15	2.05	ESMM161VSN561MR20S		560	25.4 × 30	0.15	2.15	ESMM201VSN561MQ30S
	680	22 × 35	0.15	2.35	ESMM161VSN681MP35S		560	30 × 25	0.15	2.15	ESMM201VSN561MR25S
	680	25.4 × 30	0.15	2.33	ESMM161VSN681MQ30S		560	35 × 20	0.15	2.05	ESMM201VSN561MA20S
	680	30 × 25	0.15	2.33	ESMM161VSN681MR25S		680	22 × 40	0.15	2.48	ESMM201VSN681MP40S
	680	35 × 20	0.15	2.26	ESMM161VSN681MA20S		680	25.4 × 30	0.15	2.48	ESMM201VSN681MQ30S
	820	22 × 40	0.15	2.68	ESMM161VSN821MP40S		680	30 × 25	0.15	2.48	ESMM201VSN681MR25S
	820	25.4 × 30	0.15	2.65	ESMM161VSN821MQ30S		680	35 × 20	0.15	2.36	ESMM201VSN681MA20S
	820	30 × 25	0.15	2.64	ESMM161VSN821MR25S		820	22 × 45	0.15	2.81	ESMM201VSN821MP45S
	820	35 × 20	0.15	2.49	ESMM161VSN821MA20S		820	25.4 × 35	0.15	2.79	ESMM201VSN821MQ35S
	1,000	22 × 45	0.15	3.02	ESMM161VSN102MP45S		820	30 × 30	0.15	2.80	ESMM201VSN821MR30S
	1,000	25.4 × 35	0.15	3.00	ESMM161VSN102MQ35S		820	35 × 25	0.15	2.83	ESMM201VSN821MA25S
	1,000	30 × 30	0.15	2.96	ESMM161VSN102MR30S		1,000	22 × 50	0.15	3.28	ESMM201VSN102MP50S
	1,000	35 × 25	0.15	3.13	ESMM161VSN102MA25S		1,000	25.4 × 40	0.15	3.28	ESMM201VSN102MQ40S
	1,200	22 × 50	0.15	3.47	ESMM161VSN122MP50S		1,000	30 × 35	0.15	3.15	ESMM201VSN102MR35S
	1,200	25.4 × 40	0.15	3.43	ESMM161VSN122MQ40S		1,000	35 × 30	0.15	3.26	ESMM201VSN102MA30S
	1,200	30 × 30	0.15	3.41	ESMM161VSN122MR30S		1,200	25.4 × 45	0.15	3.61	ESMM201VSN122MQ45S
	1,200	35 × 25	0.15	3.40	ESMM161VSN122MA25S		1,200	30 × 35	0.15	3.61	ESMM201VSN122MR35S
	1,500	25.4 × 50	0.15	3.96	ESMM161VSN152MQ50S		1,200	35 × 30	0.15	3.57	ESMM201VSN122MA30S
	1,500	30 × 35	0.15	3.96	ESMM161VSN152MR35S		1,500	30 × 45	0.15	4.13	ESMM201VSN152MR45S
	1,500	35 × 30	0.15	3.94	ESMM161VSN152MA30S		1,500	35 × 35	0.15	4.06	ESMM201VSN152MA35S
	1,800	30 × 40	0.15	4.31	ESMM161VSN182MR40S		1,800	30 × 50	0.15	4.60	ESMM201VSN182MR50S
	1,800	35 × 35	0.15	4.28	ESMM161VSN182MA35S		1,800	35 × 40	0.15	4.59	ESMM201VSN182MA40S
2,200	30 × 50	0.15	4.96	ESMM161VSN222MR50S	2,200	35 × 45	0.15	5.25	ESMM201VSN222MA45S		
2,200	35 × 40	0.15	4.96	ESMM161VSN222MA40S							
2,700	35 × 45	0.15	5.57	ESMM161VSN272MA45S							
3,300	35 × 50	0.15	6.21	ESMM161VSN332MA50S							
180	220	22 × 20	0.15	1.18	ESMM181VSN221MP20S	220	180	22 × 20	0.15	1.06	ESMM221VSN221MP20S
	330	22 × 25	0.15	1.77	ESMM181VSN331MP25S		270	22 × 25	0.15	1.47	ESMM221VSN271MP25S
	330	25.4 × 20	0.15	1.49	ESMM181VSN331MQ20S		270	25.4 × 20	0.15	1.35	ESMM221VSN271MQ20S
	390	22 × 25	0.15	1.84	ESMM181VSN391MP25S		330	22 × 30	0.15	1.70	ESMM221VSN331MP30S
	470	22 × 30	0.15	1.91	ESMM181VSN471MP30S		330	25.4 × 25	0.15	1.69	ESMM221VSN331MQ25S
	470	25.4 × 25	0.15	2.08	ESMM181VSN471MQ25S		330	30 × 20	0.15	1.58	ESMM221VSN331MR20S
	470	30 × 20	0.15	1.88	ESMM181VSN471MR20S		390	22 × 30	0.15	1.89	ESMM221VSN391MP30S
	560	22 × 35	0.15	2.25	ESMM181VSN561MP35S		390	25.4 × 25	0.15	1.84	ESMM221VSN391MQ25S
	560	25.4 × 25	0.15	2.25	ESMM181VSN561MQ25S		390	30 × 20	0.15	1.71	ESMM221VSN391MR20S
	680	22 × 35	0.15	2.48	ESMM181VSN681MP35S		470	22 × 35	0.15	2.08	ESMM221VSN471MP35S
	680	25.4 × 30	0.15	2.50	ESMM181VSN681MQ30S		470	25.4 × 30	0.15	2.08	ESMM221VSN471MQ30S
	680	30 × 25	0.15	2.46	ESMM181VSN681MR25S		470	30 × 25	0.15	2.12	ESMM221VSN471MR25S
	680	35 × 20	0.15	2.26	ESMM181VSN681MA20S		470	35 × 20	0.15	1.88	ESMM221VSN471MA20S
	820	22 × 40	0.15	2.86	ESMM181VSN821MP40S		560	22 × 40	0.15	2.33	ESMM221VSN561MP40S
	820	25.4 × 35	0.15	2.75	ESMM181VSN821MQ35S		560	25.4 × 35	0.15	2.38	ESMM221VSN561MQ35S
	820	30 × 25	0.15	2.69	ESMM181VSN821MR25S		560	30 × 25	0.15	2.31	ESMM221VSN561MR25S
	1,000	22 × 50	0.15	3.10	ESMM181VSN102MP50S		560	35 × 20	0.15	2.14	ESMM221VSN561MA20S
	1,000	25.4 × 40	0.15	3.06	ESMM181VSN102MQ40S		680	22 × 45	0.15	2.63	ESMM221VSN681MP45S
	1,000	30 × 30	0.15	3.10	ESMM181VSN102MR30S		680	25.4 × 35	0.15	2.68	ESMM221VSN681MQ35S
	1,000	35 × 25	0.15	2.98	ESMM181VSN102MA25S		680	30 × 30	0.15	2.62	ESMM221VSN681MR30S
	1,200	25.4 × 45	0.15	3.63	ESMM181VSN122MQ45S		680	35 × 25	0.15	2.58	ESMM221VSN681MA25S
	1,200	30 × 35	0.15	3.55	ESMM181VSN122MR35S		820	25.4 × 45	0.15	3.01	ESMM221VSN821MQ45S
	1,200	35 × 30	0.15	3.49	ESMM181VSN122MA30S		820	30 × 35	0.15	2.99	ESMM221VSN821MR35S
	1,500	30 × 40	0.15	4.10	ESMM181VSN152MR40S		820	35 × 30	0.15	2.79	ESMM221VSN821MA30S
	1,500	35 × 35	0.15	4.02	ESMM181VSN152MA35S		1,000	25.4 × 50	0.15	3.40	ESMM221VSN102MQ50S
	1,800	30 × 45	0.15	4.55	ESMM181VSN182MR45S		1,000	30 × 35	0.15	3.42	ESMM221VSN102MR35S
	1,800	35 × 35	0.15	4.54	ESMM181VSN182MA35S		1,000	35 × 30	0.15	3.29	ESMM221VSN102MA30S
	2,200	35 × 40	0.15	4.83	ESMM181VSN222MA40S		1,200	30 × 40	0.15	3.88	ESMM221VSN122MR40S
	2,700	35 × 50	0.15	5.30	ESMM181VSN272MA50S		1,200	35 × 35	0.15	3.68	ESMM221VSN122MA35S
200	220	22 × 20	0.15	1.18	ESMM201VSN221MP20S	250	150	22 × 20	0.15	0.97	ESMM251VSN151MP20S
	270	22 × 25	0.15	1.37	ESMM201VSN271MP25S		180	22 × 20	0.15	1.06	ESMM251VSN181MP20S
	270	25.4 × 20	0.15	1.35	ESMM201VSN271MQ20S		220	22 × 25	0.15	1.24	ESMM251VSN221MP25S
	330	22 × 25	0.15	1.51	ESMM201VSN331MP25S		220	25.4 × 20	0.15	1.22	ESMM251VSN221MQ20S
	330	25.4 × 20	0.15	1.49	ESMM201VSN331MQ20S		270	22 × 25	0.15	1.50	ESMM251VSN271MP25S



SMMSeries

◆ STANDARD RATINGS

WV (V _{dc})	Cap (μF)	Case size φD×L(mm)	tan δ	Rated ripple current (Arms/ 85°C, 120Hz)	Part No.	WV (V _{dc})	Cap (μF)	Case size φD×L(mm)	tan δ	Rated ripple current (Arms/ 85°C, 120Hz)	Part No.
250	330	22 × 30	0.15	1.66	ESMM251VSN331MP30S	350	180	30 × 20	0.15	1.16	ESMM351VSN181MR20S
	330	25.4 × 25	0.15	1.61	ESMM251VSN331MQ25S		220	22 × 35	0.15	1.47	ESMM351VSN221MP35S
	330	30 × 20	0.15	1.58	ESMM251VSN331MR20S		220	25.4 × 30	0.15	1.53	ESMM351VSN221MQ30S
	390	22 × 35	0.15	1.88	ESMM251VSN391MP35S		220	30 × 25	0.15	1.54	ESMM351VSN221MR25S
	390	25.4 × 30	0.15	1.88	ESMM251VSN391MQ30S		220	35 × 20	0.15	1.29	ESMM351VSN221MA20S
	390	30 × 25	0.15	1.86	ESMM251VSN391MR25S		270	22 × 40	0.15	1.70	ESMM351VSN271MP40S
	390	35 × 20	0.15	1.71	ESMM251VSN391MA20S		270	25.4 × 35	0.15	1.73	ESMM351VSN271MQ35S
	470	22 × 35	0.15	2.15	ESMM251VSN471MP35S		270	30 × 25	0.15	1.80	ESMM351VSN271MR25S
	470	25.4 × 35	0.15	2.15	ESMM251VSN471MQ35S		270	35 × 20	0.15	1.49	ESMM351VSN271MA20S
	470	30 × 25	0.15	2.05	ESMM251VSN471MR25S		330	22 × 45	0.15	1.87	ESMM351VSN331MP45S
	470	35 × 20	0.15	1.88	ESMM251VSN471MA20S		330	25.4 × 35	0.15	1.97	ESMM351VSN331MQ35S
	560	22 × 40	0.15	2.48	ESMM251VSN561MP40S		330	30 × 30	0.15	2.03	ESMM351VSN331MR30S
	560	25.4 × 35	0.15	2.35	ESMM251VSN561MQ35S		330	35 × 25	0.15	1.80	ESMM351VSN331MA25S
	560	30 × 25	0.15	2.35	ESMM251VSN561MR25S		390	25.4 × 40	0.15	2.14	ESMM351VSN391MQ40S
	680	22 × 50	0.15	2.61	ESMM251VSN681MP50S		390	30 × 35	0.15	2.23	ESMM351VSN391MR35S
	680	25.4 × 40	0.15	2.67	ESMM251VSN681MQ40S		390	35 × 30	0.15	2.30	ESMM351VSN391MA30S
	680	30 × 30	0.15	2.71	ESMM251VSN681MR30S		470	25.4 × 50	0.15	2.55	ESMM351VSN471MQ50S
	680	35 × 25	0.15	2.58	ESMM251VSN681MA25S		470	30 × 35	0.15	2.53	ESMM351VSN471MR35S
	820	25.4 × 45	0.15	3.01	ESMM251VSN821MQ45S		470	35 × 30	0.15	2.55	ESMM351VSN471MA30S
	820	30 × 35	0.15	2.98	ESMM251VSN821MR35S		560	30 × 40	0.15	2.73	ESMM351VSN561MR40S
820	35 × 30	0.15	2.96	ESMM251VSN821MA30S	560	35 × 35	0.15	2.75	ESMM351VSN561MA35S		
1,000	30 × 40	0.15	3.56	ESMM251VSN102MR40S	680	30 × 50	0.15	3.15	ESMM351VSN681MR50S		
1,000	35 × 35	0.15	3.48	ESMM251VSN102MA35S	680	35 × 40	0.15	3.15	ESMM351VSN681MA40S		
1,200	30 × 45	0.15	3.99	ESMM251VSN122MR45S	820	35 × 45	0.15	3.47	ESMM351VSN821MA45S		
1,200	35 × 35	0.15	3.84	ESMM251VSN122MA35S	1,000	35 × 50	0.15	3.60	ESMM351VSN102MA50S		
1,500	35 × 40	0.15	4.33	ESMM251VSN152MA40S							
1,800	35 × 50	0.15	4.54	ESMM251VSN182MA50S							
315	100	22 × 20	0.15	0.79	ESMM3B1VSN101MP20S	400	68	22 × 20	0.15	0.65	ESMM401VSN680MP20S
	120	25.4 × 20	0.15	0.90	ESMM3B1VSN121MQ20S		82	22 × 25	0.15	0.84	ESMM401VSN820MP25S
	150	22 × 25	0.15	1.06	ESMM3B1VSN151MP25S		82	25.4 × 20	0.15	0.74	ESMM401VSN820MQ20S
	150	25.4 × 20	0.15	1.00	ESMM3B1VSN151MQ20S		100	22 × 25	0.15	0.99	ESMM401VSN101MP25S
	180	22 × 30	0.15	1.29	ESMM3B1VSN181MP30S		100	25.4 × 20	0.15	0.82	ESMM401VSN101MQ20S
	180	25.4 × 25	0.15	1.38	ESMM3B1VSN181MQ25S		120	22 × 30	0.15	1.09	ESMM401VSN121MP30S
	180	30 × 20	0.15	1.16	ESMM3B1VSN181MR20S		120	25.4 × 25	0.15	1.13	ESMM401VSN121MQ25S
	220	22 × 30	0.15	1.41	ESMM3B1VSN221MP30S		120	30 × 20	0.15	0.95	ESMM401VSN121MR20S
	220	25.4 × 25	0.15	1.47	ESMM3B1VSN221MQ25S		150	22 × 35	0.15	1.24	ESMM401VSN151MP35S
	220	30 × 20	0.15	1.28	ESMM3B1VSN221MR20S		150	25.4 × 30	0.15	1.27	ESMM401VSN151MQ30S
	270	22 × 35	0.15	1.68	ESMM3B1VSN271MP35S		150	30 × 25	0.15	1.20	ESMM401VSN151MR25S
	270	25.4 × 30	0.15	1.70	ESMM3B1VSN271MQ30S		180	22 × 40	0.15	1.41	ESMM401VSN181MP40S
	270	30 × 25	0.15	1.55	ESMM3B1VSN271MR25S		180	25.4 × 30	0.15	1.44	ESMM401VSN181MQ30S
	270	35 × 20	0.15	1.43	ESMM3B1VSN271MA20S		180	30 × 25	0.15	1.16	ESMM401VSN181MA20S
	330	22 × 40	0.15	1.91	ESMM3B1VSN331MP40S		220	22 × 45	0.15	1.58	ESMM401VSN221MP45S
	330	25.4 × 35	0.15	1.94	ESMM3B1VSN331MQ35S		220	25.4 × 35	0.15	1.64	ESMM401VSN221MQ35S
	330	30 × 25	0.15	1.98	ESMM3B1VSN331MR25S		220	30 × 30	0.15	1.66	ESMM401VSN221MR30S
	390	22 × 45	0.15	2.07	ESMM3B1VSN391MP45S		220	35 × 25	0.15	1.47	ESMM401VSN221MA25S
	390	25.4 × 40	0.15	2.11	ESMM3B1VSN391MQ40S		270	22 × 50	0.15	1.65	ESMM401VSN271MP50S
	390	30 × 30	0.15	2.15	ESMM3B1VSN391MR30S		270	25.4 × 40	0.15	1.79	ESMM401VSN271MQ40S
	390	35 × 25	0.15	1.95	ESMM3B1VSN391MA25S		270	30 × 30	0.15	1.82	ESMM401VSN271MR30S
	470	25.4 × 45	0.15	2.31	ESMM3B1VSN471MQ45S		270	35 × 25	0.15	1.63	ESMM401VSN271MA25S
	470	30 × 35	0.15	2.38	ESMM3B1VSN471MR35S		330	25.4 × 45	0.15	2.00	ESMM401VSN331MQ45S
	470	35 × 30	0.15	2.46	ESMM3B1VSN471MA30S		330	30 × 35	0.15	2.05	ESMM401VSN331MR35S
560	25.4 × 50	0.15	2.46	ESMM3B1VSN561MQ50S	330	35 × 30	0.15	2.05	ESMM401VSN331MA30S		
560	30 × 35	0.15	2.63	ESMM3B1VSN561MR35S	390	25.4 × 50	0.15	2.12	ESMM401VSN391MQ50S		
560	35 × 30	0.15	2.69	ESMM3B1VSN561MA30S	390	30 × 40	0.15	2.26	ESMM401VSN391MR40S		
680	30 × 45	0.15	2.82	ESMM3B1VSN681MR45S	390	35 × 35	0.15	2.28	ESMM401VSN391MA35S		
680	35 × 35	0.15	3.05	ESMM3B1VSN681MA35S	470	30 × 45	0.15	2.51	ESMM401VSN471MR45S		
820	30 × 50	0.15	3.28	ESMM3B1VSN821MR50S	470	35 × 35	0.15	2.54	ESMM401VSN471MA35S		
820	35 × 40	0.15	3.45	ESMM3B1VSN821MA40S	560	30 × 50	0.15	2.85	ESMM401VSN561MR50S		
1,000	35 × 45	0.15	3.59	ESMM3B1VSN102MA45S	560	35 × 40	0.15	2.85	ESMM401VSN561MA40S		
					680	35 × 50	0.15	3.10	ESMM401VSN681MA50S		
350	82	22 × 20	0.15	0.72	ESMM351VSN820MP20S	420	47	22 × 20	0.20	0.54	ESMM421VSN470MP20S
	120	22 × 25	0.15	1.04	ESMM351VSN121MP25S		56	22 × 20	0.20	0.59	ESMM421VSN560MP20S
	120	25.4 × 20	0.15	0.90	ESMM351VSN121MQ20S		68	25.4 × 20	0.20	0.68	ESMM421VSN680MQ20S
	150	22 × 30	0.15	1.20	ESMM351VSN151MP30S		82	22 × 25	0.20	0.85	ESMM421VSN820MP25S
	150	25.4 × 25	0.15	1.22	ESMM351VSN151MQ25S		82	25.4 × 20	0.20	0.74	ESMM421VSN820MQ20S
	150	30 × 20	0.15	1.06	ESMM351VSN151MR20S		100	22 × 30	0.20	0.97	ESMM421VSN101MP30S
	180	22 × 30	0.15	1.34	ESMM351VSN181MP30S		100	25.4 × 25	0.20	0.98	ESMM421VSN101MQ25S
	180	25.4 × 25	0.15	1.37	ESMM351VSN181MQ25S		100	30 × 20	0.20	0.87	ESMM421VSN101MR20S

Product specifications in this catalog are subject to change without notice. Request our product specifications before purchase and/or use. Please use our products based on the information contained in this catalog and product specifications.

Return Group Chart



LARGE CAPACITANCE ALUMINUM ELECTROLYTIC CAPACITORS

Long life snap-ins, 85°C

SMMSeries

◆STANDARD RATINGS

WV (V _{dc})	Cap (μF)	Case size φD×L(mm)	tan δ	Rated ripple current (Arms/85°C, 120Hz)	Part No.	WV (V _{dc})	Cap (μF)	Case size φD×L(mm)	tan δ	Rated ripple current (Arms/85°C, 120Hz)	Part No.
420	120	22 × 30	0.20	1.07	ESMM421VSN121MP30S	450	82	25.4 × 20	0.20	0.74	ESMM451VSN820MQ20S
	120	25.4 × 25	0.20	1.08	ESMM421VSN121MQ25S		82	30 × 20	0.20	0.79	ESMM451VSN820MR20S
	120	30 × 20	0.20	0.95	ESMM421VSN121MR20S		100	22 × 30	0.20	0.95	ESMM451VSN101MP30S
	150	22 × 35	0.20	1.21	ESMM421VSN151MP35S		100	25.4 × 25	0.20	0.97	ESMM451VSN101MQ25S
	150	25.4 × 30	0.20	1.26	ESMM421VSN151MQ30S		100	30 × 20	0.20	0.87	ESMM451VSN101MR20S
	150	30 × 25	0.20	1.30	ESMM421VSN151MR25S		120	22 × 35	0.20	1.07	ESMM451VSN121MP35S
	150	35 × 20	0.20	1.11	ESMM421VSN151MA20S		120	25.4 × 30	0.20	1.09	ESMM451VSN121MQ30S
	180	22 × 40	0.20	1.33	ESMM421VSN181MP40S		120	30 × 25	0.20	1.12	ESMM451VSN121MR25S
	180	25.4 × 35	0.20	1.42	ESMM421VSN181MQ35S		120	35 × 20	0.20	0.99	ESMM451VSN121MA20S
	180	30 × 25	0.20	1.48	ESMM421VSN181MR25S		150	22 × 40	0.20	1.18	ESMM451VSN151MP40S
	180	35 × 20	0.20	1.16	ESMM421VSN181MA20S		150	25.4 × 30	0.20	1.25	ESMM451VSN151MQ30S
	220	22 × 45	0.20	1.55	ESMM421VSN221MP45S		150	30 × 25	0.20	1.29	ESMM451VSN151MR25S
	220	25.4 × 35	0.20	1.58	ESMM421VSN221MQ35S		150	35 × 20	0.20	1.06	ESMM451VSN151MA20S
	220	30 × 30	0.20	1.65	ESMM421VSN221MR30S		180	22 × 45	0.20	1.32	ESMM451VSN181MP45S
	220	35 × 25	0.20	1.47	ESMM421VSN221MA25S		180	25.4 × 35	0.20	1.40	ESMM451VSN181MQ35S
	270	25.4 × 40	0.20	1.74	ESMM421VSN271MQ40S		180	30 × 30	0.20	1.45	ESMM451VSN181MR30S
	270	30 × 35	0.20	1.90	ESMM421VSN271MR35S		180	35 × 25	0.20	1.33	ESMM451VSN181MA25S
	270	35 × 30	0.20	1.94	ESMM421VSN271MA30S		220	22 × 50	0.20	1.48	ESMM451VSN221MP50S
	330	25.4 × 50	0.20	2.20	ESMM421VSN331MQ50S		220	25.4 × 40	0.20	1.59	ESMM451VSN221MQ40S
	330	30 × 35	0.20	1.98	ESMM421VSN331MR35S		220	30 × 30	0.20	1.64	ESMM451VSN221MR30S
	330	35 × 35	0.20	2.17	ESMM421VSN331MA35S		220	35 × 25	0.20	1.66	ESMM451VSN221MA25S
	390	30 × 40	0.20	2.22	ESMM421VSN391MR40S		270	25.4 × 45	0.20	1.73	ESMM451VSN271MQ45S
	390	35 × 35	0.20	2.27	ESMM421VSN391MA35S		270	30 × 35	0.20	1.89	ESMM451VSN271MR35S
	470	30 × 45	0.20	2.50	ESMM421VSN471MR45S		270	35 × 30	0.20	1.90	ESMM451VSN271MA30S
470	35 × 40	0.20	2.61	ESMM421VSN471MA40S	330	25.4 × 50	0.20	2.12	ESMM451VSN331MQ50S		
560	35 × 45	0.20	2.95	ESMM421VSN561MA45S	330	30 × 40	0.20	2.12	ESMM451VSN331MR40S		
680	35 × 50	0.20	3.15	ESMM421VSN681MA50S	330	35 × 35	0.20	2.15	ESMM451VSN331MA35S		
450	47	22 × 20	0.20	0.54	ESMM451VSN470MP20S	390	30 × 45	0.20	2.35	ESMM451VSN391MR45S	
	56	22 × 20	0.20	0.59	ESMM451VSN560MP20S	390	35 × 40	0.20	2.38	ESMM451VSN391MA40S	
	68	22 × 25	0.20	0.71	ESMM451VSN680MP25S	470	30 × 50	0.20	2.65	ESMM451VSN471MR50S	
	68	25.4 × 20	0.20	0.68	ESMM451VSN680MQ20S	470	35 × 45	0.20	2.68	ESMM451VSN471MA45S	
	82	22 × 25	0.20	0.86	ESMM451VSN820MP25S	560	35 × 50	0.20	2.88	ESMM451VSN561MA50S	

Return Group Chart



LARGE CAPACITANCE ALUMINUM ELECTROLYTIC CAPACITORS

High ripple snap-ins, 105°C

KMT Series

- Higher ripple current from KMS series
- Endurance with ripple current : 3,000 hours at 105°C
- Rated voltage range : 420, 450V_{dc}, Capacitance range : 82 to 680μF
- For inverter control, switching power supplies
- Non solvent resistant type
- RoHS Compliant

KMT

Higher ripple
KMS P257



SPECIFICATIONS

Items	Characteristics	
Category Temperature Range	-25 to +105°C	
Rated Voltage Range	420, 450V _{dc}	
Capacitance Tolerance	±20% (M) (at 20°C, 120Hz)	
Leakage Current	I ≤ 3/CV Where, I : Max. leakage current (μA), C : Nominal capacitance (μF), V : Rated voltage (V) (at 20°C after 5 minutes)	
Dissipation Factor (tan δ)	Rated voltage (V _{dc})	420 & 450V
	tan δ (Max.)	0.20 (at 20°C, 120Hz)
Low Temperature Characteristics (Max. Impedance Ratio)	Rated voltage (V _{dc})	420 & 450V
	Z(-25°C)/Z(+20°C)	8 (at 120Hz)
Endurance	The following specifications shall be satisfied when the capacitors are restored to 20°C after subjected to DC voltage with the rated ripple current is applied (the peak voltage shall not exceed the rated voltage) for 3,000 hours at 105°C.	
	Capacitance change	≤ ±20% of the initial value
	D.F. (tan δ)	≤ 200% of the initial specified value
	Leakage current	≤ The initial specified value
Shelf Life	The following specifications shall be satisfied when the capacitors are restored to 20°C after exposing them for 1,000 hours at 105°C without voltage applied. Before the measurement, the capacitor shall be preconditioned by applying voltage according to Item 4.1 of JIS C 5101-4.	
	Capacitance change	≤ ±15% of the initial value
	D.F. (tan δ)	≤ 150% of the initial specified value
	Leakage current	≤ The initial specified value

DIMENSIONS [mm]

● Terminal Code : VS (φ22 to φ35) : Standard

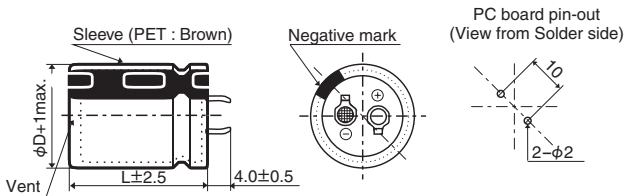

● Terminal Code : LI (φ35)

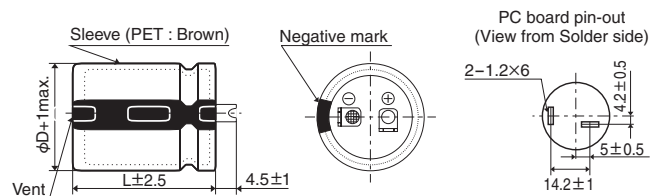

The standard design has no plastic disc.

PART NUMBERING SYSTEM

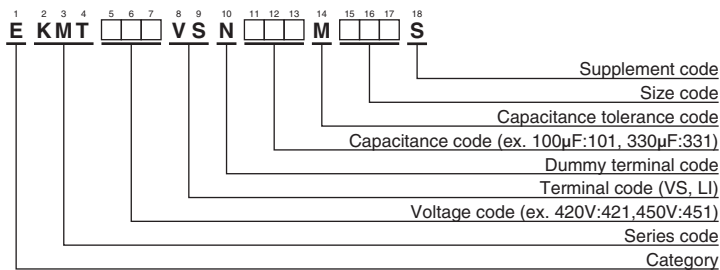

Please refer to "Product code guide (snap-in type)"

Return Group Chart



LARGE CAPACITANCE ALUMINUM ELECTROLYTIC CAPACITORS

High ripple snap-ins, 105°C

KMT Series

◆STANDARD RATINGS

WV (V _{dc})	Cap (μF)	Case size φD×L(mm)	tan δ	Rated ripple current (Arms/105°C, 120Hz)	Part No.	WV (V _{dc})	Cap (μF)	Case size φD×L(mm)	tan δ	Rated ripple current (Arms/105°C, 120Hz)	Part No.
420	100	22 × 25	0.20	0.89	EKMT421VSN101MP25S	450	82	22 × 25	0.20	0.81	EKMT451VSN820MP25S
	120	22 × 30	0.20	1.06	EKMT421VSN121MP30S		100	22 × 30	0.20	0.97	EKMT451VSN101MP30S
	120	25.4 × 25	0.20	1.09	EKMT421VSN121MQ25S		100	25.4 × 25	0.20	1.04	EKMT451VSN101MQ25S
	150	22 × 35	0.20	1.21	EKMT421VSN151MP35S		120	22 × 35	0.20	1.08	EKMT451VSN121MP35S
	180	22 × 40	0.20	1.34	EKMT421VSN181MP40S		150	22 × 40	0.20	1.22	EKMT451VSN151MP40S
	180	25.4 × 30	0.20	1.28	EKMT421VSN181MQ30S		150	25.4 × 35	0.20	1.31	EKMT451VSN151MQ35S
	180	30 × 25	0.20	1.42	EKMT421VSN181MR25S		150	30 × 25	0.20	1.31	EKMT451VSN151MR25S
	220	22 × 45	0.20	1.47	EKMT421VSN221MP45S		180	22 × 45	0.20	1.35	EKMT451VSN181MP45S
	220	22 × 50	0.20	1.60	EKMT421VSN221MP50S		180	22 × 50	0.20	1.42	EKMT451VSN181MP50S
	220	25.4 × 35	0.20	1.47	EKMT421VSN221MQ35S		180	25.4 × 40	0.20	1.35	EKMT451VSN181MQ40S
	220	30 × 30	0.20	1.64	EKMT421VSN221MR30S		180	30 × 30	0.20	1.49	EKMT451VSN181MR30S
	220	35 × 25	0.20	1.64	EKMT421VSN221MA25S		180	35 × 25	0.20	1.60	EKMT451VSN181MA25S
	270	25.4 × 40	0.20	1.63	EKMT421VSN271MQ40S		220	25.4 × 45	0.20	1.55	EKMT451VSN221MQ45S
	270	25.4 × 45	0.20	1.79	EKMT421VSN271MQ45S		220	30 × 35	0.20	1.71	EKMT451VSN221MR35S
	270	30 × 35	0.20	1.87	EKMT421VSN271MR35S		270	25.4 × 50	0.20	1.74	EKMT451VSN271MQ50S
	330	25.4 × 50	0.20	1.93	EKMT421VSN331MQ50S		270	30 × 40	0.20	1.90	EKMT451VSN271MR40S
	330	30 × 40	0.20	2.10	EKMT421VSN331MR40S		270	35 × 30	0.20	1.90	EKMT451VSN271MA30S
	330	35 × 30	0.20	2.05	EKMT421VSN331MA30S		330	30 × 45	0.20	2.20	EKMT451VSN331MR45S
	390	30 × 45	0.20	2.32	EKMT421VSN391MR45S		330	35 × 35	0.20	2.20	EKMT451VSN331MA35S
	390	35 × 35	0.20	2.32	EKMT421VSN391MA35S		390	30 × 50	0.20	2.40	EKMT451VSN391MR50S
470	30 × 50	0.20	2.51	EKMT421VSN471MR50S	390	35 × 40	0.20	2.42	EKMT451VSN391MA40S		
470	35 × 40	0.20	2.62	EKMT421VSN471MA40S	470	35 × 45	0.20	2.67	EKMT451VSN471MA45S		
560	35 × 45	0.20	2.88	EKMT421VSN561MA45S	560	35 × 50	0.20	2.85	EKMT451VSN561MA50S		
680	35 × 50	0.20	3.10	EKMT421VSN681MA50S							

◆RATED RIPPLE CURRENT MULTIPLIERS

● Frequency Multipliers

Frequency(Hz)	50	120	300	1k	10k	50k
420, 450V _{dc}	0.68	1.00	1.16	1.30	1.41	1.43

The endurance of capacitors is reduced with internal heating produced by ripple current at the rate of halving the lifetime with every 5°C rise. When long life performance is required in actual use, the rms ripple current has to be reduced.

Return Group Chart



LARGE CAPACITANCE ALUMINUM ELECTROLYTIC CAPACITORS

Downsized snap-ins, 105°C

KMS Series *Upgrade!*

- For solar power generation
- Added 550V
- Endurance with ripple current : 105°C 3,000 hours
- Rated voltage range : 160 to 550V
- Capacitance range : 47 to 3,300μF
- Non solvent resistant type
- RoHS Compliant

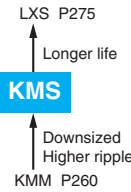

550V Lineup!



◆ SPECIFICATIONS

Items	Characteristics		
Category	-25 to +105°C		
Temperature Range	-25 to +105°C		
Rated Voltage Range	160 to 550V _{dc}		
Capacitance Tolerance	±20% (M) (at 20°C, 120Hz)		
Leakage Current	$I \leq 3\sqrt{CV}$ Where, I : Max. leakage current (μA), C : Nominal capacitance (μF), V : Rated voltage (V) (at 20°C after 5 minutes)		
Dissipation Factor (tan δ)	Rated voltage (V _{dc})	160 to 400V	420 to 550V
	tan δ (Max.)	0.15	0.20
Low Temperature Characteristics (Max. Impedance Ratio)	Rated voltage (V _{dc})	160 to 400V	420 to 550V
	Z(-25°C)/Z(+20°C)	4	8
Endurance	The following specifications shall be satisfied when the capacitors are restored to 20°C after subjected to DC voltage with the rated ripple current is applied (the peak voltage shall not exceed the rated voltage) for 3,000 hours at 105°C.		
	Capacitance change	≤ ±20% of the initial value	
	D.F. (tan δ)	≤200% of the initial specified value	
	Leakage current	≤The initial specified value	
Shelf Life	The following specifications shall be satisfied when the capacitors are restored to 20°C after exposing them for 1,000 hours at 105°C without voltage applied. Before the measurement, the capacitor shall be preconditioned by applying voltage according to Item 4.1 of JIS C 5101-4.		
	Capacitance change	≤ ±15% of the initial value	
	D.F. (tan δ)	≤150% of the initial specified value	
	Leakage current	≤The initial specified value	

◆ DIMENSIONS [mm]

● Terminal Code : VS (φ22 to φ35) : Standard

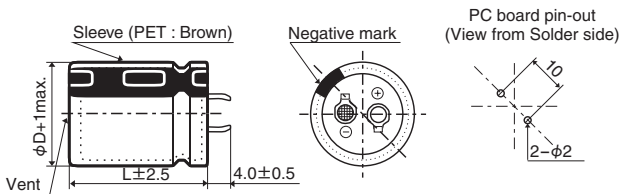

● Terminal Code : LI (φ35)

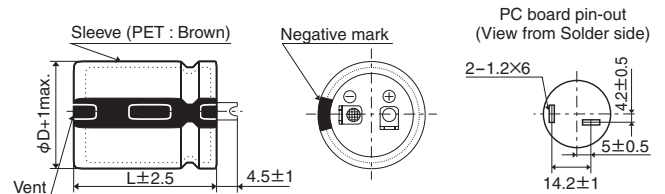

The standard design has no plastic disc.

◆ PART NUMBERING SYSTEM

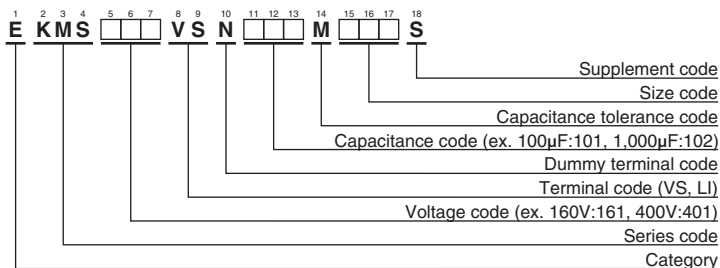

Please refer to "Product code guide (snap-in type)"

Return Group Chart



LARGE CAPACITANCE ALUMINUM ELECTROLYTIC CAPACITORS

Downsized snap-ins, 105°C



◆ STANDARD RATINGS

WV (V _{dc})	Cap (μF)	Case size φD×L(mm)	tan δ	Rated ripple current (Arms/ 105°C, 120Hz)	Part No.	WV (V _{dc})	Cap (μF)	Case size φD×L(mm)	tan δ	Rated ripple current (Arms/ 105°C, 120Hz)	Part No.
160	470	22 × 25	0.15	1.47	EKMS161VSN471MP25S	200	1,800	30 × 45	0.15	3.66	EKMS201VSN182MR45S
	680	22 × 30	0.15	1.86	EKMS161VSN681MP30S		1,800	30 × 50	0.15	3.72	EKMS201VSN182MR50S
	680	25.4 × 25	0.15	1.84	EKMS161VSN681MQ25S		1,800	35 × 40	0.15	3.81	EKMS201VSN182MA40S
	820	22 × 35	0.15	2.09	EKMS161VSN821MP35S		2,200	35 × 45	0.15	4.32	EKMS201VSN222MA45S
	820	25.4 × 30	0.15	2.08	EKMS161VSN821MQ30S		2,700	35 × 50	0.15	4.88	EKMS201VSN272MA50S
	1,000	22 × 40	0.15	2.35	EKMS161VSN102MP40S		270	22 × 25	0.15	1.11	EKMS251VSN271MP25S
	1,000	22 × 45	0.15	2.40	EKMS161VSN102MP45S		330	22 × 30	0.15	1.29	EKMS251VSN331MP30S
	1,000	25.4 × 35	0.15	2.40	EKMS161VSN102MQ35S		390	22 × 35	0.15	1.44	EKMS251VSN391MP35S
	1,000	30 × 25	0.15	2.50	EKMS161VSN102MR25S		390	25.4 × 25	0.15	1.40	EKMS251VSN391MQ25S
	1,200	22 × 50	0.15	2.69	EKMS161VSN122MP50S		470	22 × 40	0.15	1.61	EKMS251VSN471MP40S
	1,200	25.4 × 40	0.15	2.68	EKMS161VSN122MQ40S		470	25.4 × 30	0.15	1.57	EKMS251VSN471MQ30S
	1,200	30 × 30	0.15	2.77	EKMS161VSN122MR30S		560	22 × 45	0.15	1.79	EKMS251VSN561MP45S
	1,200	35 × 25	0.15	2.91	EKMS161VSN122MA25S		560	25.4 × 35	0.15	1.79	EKMS251VSN561MQ35S
	1,500	25.4 × 45	0.15	3.05	EKMS161VSN152MQ45S		560	30 × 25	0.15	1.87	EKMS251VSN561MR25S
	1,500	30 × 35	0.15	3.17	EKMS161VSN152MR35S		680	22 × 50	0.15	2.02	EKMS251VSN681MP50S
	1,800	25.4 × 50	0.15	3.40	EKMS161VSN182MQ50S		680	25.4 × 40	0.15	2.02	EKMS251VSN681MQ40S
	1,800	30 × 40	0.15	3.57	EKMS161VSN182MR40S		680	30 × 30	0.15	2.08	EKMS251VSN681MR30S
	1,800	35 × 30	0.15	3.62	EKMS161VSN182MA30S		680	35 × 25	0.15	2.19	EKMS251VSN681MA25S
	2,200	30 × 45	0.15	4.05	EKMS161VSN222MQ45S		820	25.4 × 45	0.15	2.26	EKMS251VSN821MQ45S
	2,200	35 × 35	0.15	4.07	EKMS161VSN222MA35S		820	30 × 35	0.15	2.34	EKMS251VSN821MR35S
2,700	30 × 50	0.15	4.56	EKMS161VSN272MR50S	1,000	25.4 × 50	0.15	2.53	EKMS251VSN102MQ50S		
2,700	35 × 40	0.15	4.67	EKMS161VSN272MA40S	1,000	30 × 40	0.15	2.66	EKMS251VSN102MR40S		
2,700	35 × 45	0.15	4.78	EKMS161VSN272MA45S	1,000	35 × 30	0.15	2.70	EKMS251VSN102MA30S		
3,300	35 × 50	0.15	5.40	EKMS161VSN332MA50S	1,200	30 × 45	0.15	2.99	EKMS251VSN122MR45S		
180	390	22 × 25	0.15	1.34	EKMS181VSN391MP25S	1,200	30 × 50	0.15	3.04	EKMS251VSN122MR50S	
	560	22 × 30	0.15	1.68	EKMS181VSN561MP30S	1,200	35 × 35	0.15	3.00	EKMS251VSN122MA35S	
	560	25.4 × 25	0.15	1.67	EKMS181VSN561MQ25S	1,500	35 × 40	0.15	3.48	EKMS251VSN152MA40S	
	680	22 × 35	0.15	1.90	EKMS181VSN681MP35S	1,500	35 × 45	0.15	3.56	EKMS251VSN152MA45S	
	820	22 × 40	0.15	2.13	EKMS181VSN821MP40S	1,800	35 × 50	0.15	3.98	EKMS251VSN182MA50S	
	820	25.4 × 30	0.15	2.08	EKMS181VSN821MQ30S	180	22 × 25	0.15	0.95	EKMS3B1VSN181MP25S	
	820	30 × 25	0.15	2.26	EKMS181VSN821MR25S	220	22 × 30	0.15	1.10	EKMS3B1VSN221MP30S	
	1,000	22 × 45	0.15	2.40	EKMS181VSN102MP45S	220	25.4 × 25	0.15	1.10	EKMS3B1VSN221MQ25S	
	1,000	22 × 50	0.15	2.45	EKMS181VSN102MP50S	270	22 × 35	0.15	1.24	EKMS3B1VSN271MP35S	
	1,000	25.4 × 35	0.15	2.40	EKMS181VSN102MQ35S	330	22 × 40	0.15	1.40	EKMS3B1VSN331MP40S	
	1,000	25.4 × 40	0.15	2.45	EKMS181VSN102MQ40S	330	25.4 × 30	0.15	1.38	EKMS3B1VSN331MQ30S	
	1,000	30 × 30	0.15	2.52	EKMS181VSN102MR30S	330	30 × 25	0.15	1.43	EKMS3B1VSN331MR25S	
	1,200	25.4 × 45	0.15	2.73	EKMS181VSN122MQ45S	390	22 × 45	0.15	1.56	EKMS3B1VSN391MP45S	
	1,200	30 × 35	0.15	2.83	EKMS181VSN122MR35S	390	22 × 50	0.15	1.59	EKMS3B1VSN391MP50S	
	1,200	35 × 25	0.15	2.91	EKMS181VSN122MA25S	390	25.4 × 35	0.15	1.57	EKMS3B1VSN391MQ35S	
	1,500	25.4 × 50	0.15	3.10	EKMS181VSN152MQ50S	470	25.4 × 40	0.15	1.76	EKMS3B1VSN471MQ40S	
	1,500	30 × 40	0.15	3.26	EKMS181VSN152MR40S	470	30 × 30	0.15	1.73	EKMS3B1VSN471MR30S	
	1,500	35 × 30	0.15	3.31	EKMS181VSN152MA30S	470	35 × 25	0.15	1.82	EKMS3B1VSN471MA25S	
	1,800	30 × 45	0.15	3.66	EKMS181VSN182MR45S	560	25.4 × 45	0.15	1.96	EKMS3B1VSN561MQ45S	
	1,800	35 × 35	0.15	3.68	EKMS181VSN182MA35S	560	25.4 × 50	0.15	1.99	EKMS3B1VSN561MQ50S	
2,200	30 × 50	0.15	4.11	EKMS181VSN222MR50S	560	30 × 35	0.15	1.93	EKMS3B1VSN561MR35S		
2,200	35 × 40	0.15	4.22	EKMS181VSN222MA40S	560	35 × 30	0.15	2.02	EKMS3B1VSN561MA30S		
2,700	35 × 45	0.15	4.78	EKMS181VSN272MA45S	680	30 × 40	0.15	2.19	EKMS3B1VSN681MR40S		
2,700	35 × 50	0.15	4.88	EKMS181VSN272MA50S	680	35 × 35	0.15	2.26	EKMS3B1VSN681MA35S		
200	390	22 × 25	0.15	1.34	EKMS201VSN391MP25S	820	30 × 45	0.15	2.47	EKMS3B1VSN821MR45S	
	470	22 × 30	0.15	1.54	EKMS201VSN471MP30S	820	30 × 50	0.15	2.51	EKMS3B1VSN821MR50S	
	560	22 × 35	0.15	1.72	EKMS201VSN561MP35S	820	35 × 40	0.15	2.57	EKMS3B1VSN821MA40S	
	560	25.4 × 25	0.15	1.67	EKMS201VSN561MQ25S	1,000	35 × 45	0.15	2.91	EKMS3B1VSN102MA45S	
	680	22 × 40	0.15	1.94	EKMS201VSN681MP40S	1,200	35 × 50	0.15	3.25	EKMS3B1VSN122MA50S	
	680	25.4 × 30	0.15	1.89	EKMS201VSN681MQ30S	120	22 × 25	0.15	0.77	EKMS401VSN121MP25S	
	820	22 × 45	0.15	2.17	EKMS201VSN821MP45S	150	22 × 30	0.15	0.90	EKMS401VSN151MP30S	
	820	25.4 × 35	0.15	2.17	EKMS201VSN821MQ35S	180	22 × 35	0.15	1.02	EKMS401VSN181MP35S	
	820	30 × 25	0.15	2.26	EKMS201VSN821MR25S	180	25.4 × 25	0.15	0.99	EKMS401VSN181MQ25S	
	1,000	22 × 50	0.15	2.45	EKMS201VSN102MP50S	220	22 × 40	0.15	1.15	EKMS401VSN221MP40S	
	1,000	25.4 × 40	0.15	2.45	EKMS201VSN102MQ40S	220	25.4 × 30	0.15	1.13	EKMS401VSN221MQ30S	
	1,000	30 × 30	0.15	2.52	EKMS201VSN102MR30S	270	22 × 45	0.15	1.29	EKMS401VSN271MP45S	
	1,000	35 × 25	0.15	2.66	EKMS201VSN102MA25S	270	25.4 × 35	0.15	1.30	EKMS401VSN271MQ35S	
	1,200	25.4 × 45	0.15	2.73	EKMS201VSN122MQ45S	270	30 × 25	0.15	1.29	EKMS401VSN271MR25S	
	1,200	25.4 × 50	0.15	2.78	EKMS201VSN122MQ50S	330	22 × 50	0.15	1.47	EKMS401VSN331MP50S	
	1,200	30 × 35	0.15	2.83	EKMS201VSN122MR35S	330	25.4 × 40	0.15	1.47	EKMS401VSN331MQ40S	
	1,200	35 × 30	0.15	2.96	EKMS201VSN122MA30S	330	30 × 30	0.15	1.45	EKMS401VSN331MR30S	
	1,500	30 × 40	0.15	3.26	EKMS201VSN152MR40S	330	35 × 25	0.15	1.52	EKMS401VSN331MA25S	
	1,500	35 × 35	0.15	3.36	EKMS201VSN152MA35S	390	25.4 × 45	0.15	1.63	EKMS401VSN391MQ45S	

Product specifications in this catalog are subject to change without notice. Request our product specifications before purchase and/or use. Please use our products based on the information contained in this catalog and product specifications.

Return Group Chart



LARGE CAPACITANCE ALUMINUM ELECTROLYTIC CAPACITORS

Downsized snap-ins, 105°C



◆ STANDARD RATINGS

WV (V _{dc})	Cap (µF)	Case size φD×L(mm)	tan δ	Rated ripple current (Arms/ 105°C, 120Hz)	Part No.	WV (V _{dc})	Cap (µF)	Case size φD×L(mm)	tan δ	Rated ripple current (Arms/ 105°C, 120Hz)	Part No.	
												400
	390	30 × 35	0.15	1.61	EKMS401VSN391MR35S	390	30 × 45	0.20	1.70	EKMS451VSN391MR45S		
	470	30 × 40	0.15	1.82	EKMS401VSN471MR40S	390	30 × 50	0.20	1.73	EKMS451VSN391MR50S		
	470	35 × 30	0.15	1.85	EKMS401VSN471MA30S	390	35 × 35	0.20	1.71	EKMS451VSN391MA35S		
	560	30 × 45	0.15	2.04	EKMS401VSN561MR45S	470	35 × 40	0.20	1.95	EKMS451VSN471MA40S		
	560	30 × 50	0.15	2.07	EKMS401VSN561MR50S	470	35 × 45	0.20	1.99	EKMS451VSN471MA45S		
	560	35 × 35	0.15	2.05	EKMS401VSN561MA35S	560	35 × 50	0.20	2.22	EKMS451VSN561MA50S		
	680	35 × 40	0.15	2.34	EKMS401VSN681MA40S	500	47	22 × 25	0.20	0.51	EKMS501VSN470MP25S	
	680	35 × 45	0.15	2.40	EKMS401VSN681MA45S		56	22 × 30	0.20	0.58	EKMS501VSN560MP30S	
	820	35 × 50	0.15	2.69	EKMS401VSN821MA50S		68	25.4 × 25	0.20	0.65	EKMS501VSN680MQ25S	
420	100	22 × 25	0.20	0.70	EKMS421VSN101MP25S		82	22 × 35	0.20	0.72	EKMS501VSN820MP35S	
	120	22 × 30	0.20	0.81	EKMS421VSN121MP30S		82	25.4 × 30	0.20	0.74	EKMS501VSN820MQ30S	
	120	25.4 × 25	0.20	0.81	EKMS421VSN121MQ25S		100	22 × 45	0.20	0.83	EKMS501VSN101MP45S	
	150	22 × 35	0.20	0.93	EKMS421VSN151MP35S		100	30 × 25	0.20	0.82	EKMS501VSN101MR25S	
	180	22 × 40	0.20	1.04	EKMS421VSN181MP40S		120	22 × 50	0.20	0.93	EKMS501VSN121MR50S	
	180	25.4 × 30	0.20	1.02	EKMS421VSN181MQ30S		120	25.4 × 35	0.20	0.93	EKMS501VSN121MQ35S	
	180	30 × 25	0.20	1.06	EKMS421VSN181MR25S		120	30 × 30	0.20	0.91	EKMS501VSN121MR30S	
	220	22 × 45	0.20	1.17	EKMS421VSN221MP45S	150	25.4 × 45	0.20	1.08	EKMS501VSN151MQ45S		
	220	22 × 50	0.20	1.20	EKMS421VSN221MP50S	150	30 × 35	0.20	1.04	EKMS501VSN151MR35S		
	220	25.4 × 35	0.20	1.18	EKMS421VSN221MQ35S	150	35 × 25	0.20	0.99	EKMS501VSN151MA25S		
450	220	30 × 30	0.20	1.18	EKMS421VSN221MR30S	180	25.4 × 50	0.20	1.20	EKMS501VSN181MQ50S		
	270	25.4 × 40	0.20	1.33	EKMS421VSN271MQ40S	180	30 × 40	0.20	1.17	EKMS501VSN181MR40S		
	270	25.4 × 45	0.20	1.36	EKMS421VSN271MQ45S	180	35 × 30	0.20	1.10	EKMS501VSN181MA30S		
	270	35 × 25	0.20	1.38	EKMS421VSN271MA25S	220	30 × 45	0.20	1.33	EKMS501VSN221MR45S		
	330	25.4 × 50	0.20	1.52	EKMS421VSN331MQ50S	220	35 × 35	0.20	1.23	EKMS501VSN221MA35S		
	330	30 × 35	0.20	1.48	EKMS421VSN331MR35S	270	30 × 50	0.20	1.50	EKMS501VSN271MR50S		
	330	30 × 40	0.20	1.52	EKMS421VSN331MR40S	270	35 × 40	0.20	1.42	EKMS501VSN271MA40S		
	330	35 × 30	0.20	1.55	EKMS421VSN331MA30S	330	35 × 45	0.20	1.60	EKMS501VSN331MA45S		
	390	30 × 45	0.20	1.70	EKMS421VSN391MR45S	390	35 × 50	0.20	1.78	EKMS501VSN391MA50S		
	390	35 × 35	0.20	1.71	EKMS421VSN391MA35S	470	35 × 60	0.20	2.03	EKMS501VSN471MA60S		
470	30 × 50	0.20	1.90	EKMS421VSN471MR50S	550	82	22 × 35	0.20	0.72	EKMS551VSN820MP35S		
470	35 × 40	0.20	1.95	EKMS421VSN471MA40S		82	25.4 × 30	0.20	0.74	EKMS551VSN820MQ30S		
560	35 × 45	0.20	2.17	EKMS421VSN561MA45S		100	22 × 45	0.20	0.83	EKMS551VSN101MP45S		
680	35 × 50	0.20	2.45	EKMS421VSN681MA50S		100	25.4 × 35	0.20	0.85	EKMS551VSN101MQ35S		
450	82	22 × 25	0.20	0.64		EKMS451VSN820MP25S	100	30 × 25	0.20	0.82	EKMS551VSN101MR25S	
	120	22 × 30	0.20	0.81		EKMS451VSN121MP30S	120	22 × 50	0.20	0.93	EKMS551VSN121MP50S	
	120	22 × 35	0.20	0.83		EKMS451VSN121MP35S	120	25.4 × 40	0.20	0.95	EKMS551VSN121MQ40S	
	120	25.4 × 25	0.20	0.81		EKMS451VSN121MQ25S	120	30 × 30	0.20	0.91	EKMS551VSN121MR30S	
	150	22 × 40	0.20	0.94		EKMS451VSN151MP40S	120	35 × 25	0.20	0.88	EKMS551VSN121MA25S	
	150	25.4 × 30	0.20	0.93		EKMS451VSN151MQ30S	150	25.4 × 45	0.20	1.08	EKMS551VSN151MQ45S	
	180	22 × 45	0.20	1.06	EKMS451VSN181MP45S	150	30 × 35	0.20	1.04	EKMS551VSN151MR35S		
	180	25.4 × 35	0.20	1.06	EKMS451VSN181MQ35S	180	25.4 × 50	0.20	1.20	EKMS551VSN181MQ50S		
	180	30 × 25	0.20	1.06	EKMS451VSN181MR25S	180	30 × 40	0.20	1.17	EKMS551VSN181MR40S		
	220	22 × 50	0.20	1.20	EKMS451VSN221MP50S	180	35 × 30	0.20	1.10	EKMS551VSN181MA30S		
220	25.4 × 40	0.20	1.20	EKMS451VSN221MQ40S	220	30 × 45	0.20	1.33	EKMS551VSN221MR45S			
220	30 × 30	0.20	1.18	EKMS451VSN221MR30S	220	35 × 35	0.20	1.23	EKMS551VSN221MA35S			
220	35 × 25	0.20	1.24	EKMS451VSN221MA25S	270	30 × 50	0.20	1.50	EKMS551VSN271MR50S			
270	25.4 × 45	0.20	1.36	EKMS451VSN271MQ45S	270	35 × 40	0.20	1.42	EKMS551VSN271MA40S			
270	25.4 × 50	0.20	1.38	EKMS451VSN271MQ50S	330	35 × 45	0.20	1.60	EKMS551VSN331MA45S			
270	30 × 35	0.20	1.34	EKMS451VSN271MR35S	330	35 × 50	0.20	1.64	EKMS551VSN331MA50S			
270	35 × 30	0.20	1.40	EKMS451VSN271MA30S	470	35 × 60	0.20	2.03	EKMS551VSN471MA60S			

◆ RATED RIPPLE CURRENT MULTIPLIERS

● Frequency Multipliers

Frequency(Hz)	50	120	300	1k	10k	50k
160 to 250V _{dc}	0.81	1.00	1.17	1.32	1.45	1.50
315 to 450V _{dc}	0.77	1.00	1.16	1.30	1.41	1.43
500, 550V _{dc}	0.70	1.00	1.16	1.30	1.41	1.43

The endurance of capacitors is reduced with internal heating produced by ripple current at the rate of halving the lifetime with every 5°C rise. When long life performance is required in actual use, the rms ripple current has to be reduced.

Return Group Chart



LARGE CAPACITANCE ALUMINUM ELECTROLYTIC CAPACITORS

Long life snap-ins, 105°C

KMM Series

- Longer life from KMQ series
- Endurance with ripple current : 2,000 to 3,000 hours at 105°C
- Non solvent resistant type
- RoHS Compliant

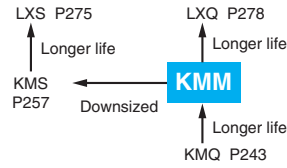

SPECIFICATIONS

Items	Characteristics		
Category	-25 to +105°C		
Temperature Range	-25 to +105°C		
Rated Voltage Range	160 to 450V _{dc}		
Capacitance Tolerance	±20% (M) (at 20°C, 120Hz)		
Leakage Current	I ≤ 3/CV Where, I : Max. leakage current (µA), C : Nominal capacitance (µF), V : Rated voltage (V) (at 20°C after 5 minutes)		
Dissipation Factor (tan δ)	Rated voltage (V _{dc})	160 to 400V	420 & 450V
	tan δ (Max.)	0.15	0.20
Low Temperature Characteristics (Max. Impedance Ratio)	Rated voltage (V _{dc})	160 to 400V	420 & 450V
	Z(-25°C)/Z(+20°C)	4	8
Endurance	The following specifications shall be satisfied when the capacitors are restored to 20°C after subjected to DC voltage with the rated ripple current is applied (the peak voltage shall not exceed the rated voltage) for 3,000 hours at 105°C.		
	Capacitance change	≤ ±20% of the initial value	
	D.F. (tan δ)	≤ 200% of the initial specified value	
	Leakage current	≤ The initial specified value	
Shelf Life	The following specifications shall be satisfied when the capacitors are restored to 20°C after exposing them for 1,000 hours at 105°C without voltage applied. Before the measurement, the capacitor shall be preconditioned by applying voltage according to Item 4.1 of JIS C 5101-4.		
	Capacitance change	≤ ±15% of the initial value	
	D.F. (tan δ)	≤ 150% of the initial specified value	
	Leakage current	≤ The initial specified value	

DIMENSIONS [mm]

● Terminal Code : VS (φ22 to φ35) : Standard

● Terminal Code : LI (φ35)

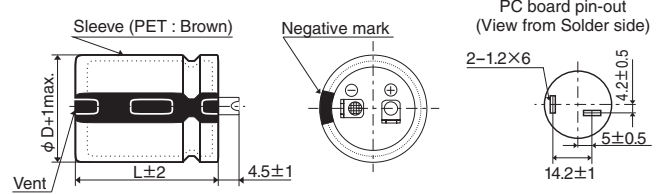
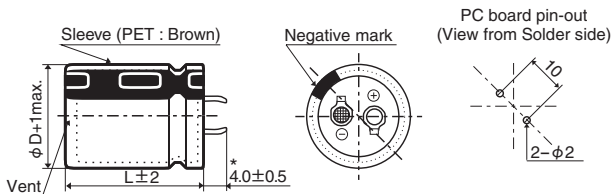

* φD=35mm : 3.5±0.5mm

The standard design has no plastic disc.

PART NUMBERING SYSTEM

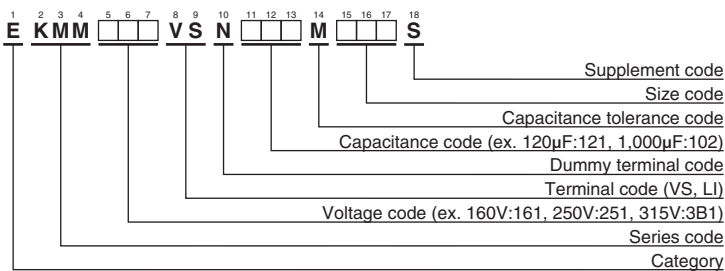

Please refer to "Product code guide (snap-in type)"

◆ STANDARD RATINGS

WV (V _{dc})	Cap (μF)	Case size φD×L(mm)	tan δ	Rated ripple current (Arms/ 105°C, 120Hz)	Part No.	WV (V _{dc})	Cap (μF)	Case size φD×L(mm)	tan δ	Rated ripple current (Arms/ 105°C, 120Hz)	Part No.
160	220	22 × 20	0.15	0.81	EKMM161VSN221MP20S	180	1,200	25.4 × 50	0.15	2.55	EKMM181VSN122MQ50S
	270	25.4 × 20	0.15	0.98	EKMM161VSN271MQ20S		1,200	30 × 40	0.15	2.55	EKMM181VSN122MR40S
	330	22 × 25	0.15	1.20	EKMM161VSN331MP25S		1,200	35 × 30	0.15	2.55	EKMM181VSN122MA30S
	330	25.4 × 20	0.15	1.02	EKMM161VSN331MQ20S		1,500	30 × 45	0.15	2.90	EKMM181VSN152MR45S
	390	22 × 25	0.15	1.30	EKMM161VSN391MP25S		1,500	35 × 35	0.15	2.90	EKMM181VSN152MA35S
	390	25.4 × 25	0.15	1.26	EKMM161VSN391MQ25S		1,800	30 × 60	0.15	3.49	EKMM181VSN182MR60S
	390	30 × 20	0.15	1.25	EKMM161VSN391MR20S		1,800	35 × 40	0.15	3.30	EKMM181VSN182MA40S
	470	22 × 30	0.15	1.55	EKMM161VSN471MP30S		2,200	35 × 50	0.15	3.65	EKMM181VSN222MA50S
	470	25.4 × 25	0.15	1.55	EKMM161VSN471MQ25S		2,700	35 × 60	0.15	4.19	EKMM181VSN272MA60S
	470	30 × 20	0.15	1.30	EKMM161VSN471MR20S		150	22 × 20	0.15	0.73	EKMM201VSN151MP20S
	560	22 × 35	0.15	1.67	EKMM161VSN561MP35S		180	22 × 20	0.15	0.80	EKMM201VSN181MP20S
	560	25.4 × 30	0.15	1.67	EKMM161VSN561MQ30S		220	25.4 × 20	0.15	0.85	EKMM201VSN221MQ20S
	560	30 × 25	0.15	1.67	EKMM161VSN561MR25S		270	22 × 25	0.15	1.10	EKMM201VSN271MP25S
	560	35 × 20	0.15	1.46	EKMM161VSN561MA20S		270	30 × 20	0.15	1.05	EKMM201VSN271MR20S
	680	22 × 40	0.15	1.82	EKMM161VSN681MP40S		330	22 × 30	0.15	1.25	EKMM201VSN331MP30S
	680	25.4 × 30	0.15	1.82	EKMM161VSN681MQ30S		330	25.4 × 25	0.15	1.25	EKMM201VSN331MQ25S
	680	30 × 25	0.15	1.82	EKMM161VSN681MR25S		330	30 × 20	0.15	1.10	EKMM201VSN331MR20S
	680	35 × 20	0.15	1.51	EKMM161VSN681MA20S		390	22 × 30	0.15	1.35	EKMM201VSN391MP30S
	820	22 × 45	0.15	2.04	EKMM161VSN821MP45S	390	25.4 × 25	0.15	1.35	EKMM201VSN391MQ25S	
	820	25.4 × 35	0.15	2.04	EKMM161VSN821MQ35S	390	35 × 20	0.15	1.30	EKMM201VSN391MA20S	
	820	30 × 30	0.15	2.04	EKMM161VSN821MR30S	470	22 × 35	0.15	1.50	EKMM201VSN471MP35S	
	820	35 × 25	0.15	2.04	EKMM161VSN821MA25S	470	25.4 × 30	0.15	1.50	EKMM201VSN471MQ30S	
	1,000	22 × 50	0.15	2.25	EKMM161VSN102MP50S	470	30 × 25	0.15	1.50	EKMM201VSN471MR25S	
	1,000	25.4 × 40	0.15	2.25	EKMM161VSN102MQ40S	470	35 × 20	0.15	1.41	EKMM201VSN471MA20S	
	1,000	30 × 30	0.15	2.25	EKMM161VSN102MR30S	560	22 × 40	0.15	1.67	EKMM201VSN561MP40S	
	1,000	35 × 25	0.15	2.25	EKMM161VSN102MA25S	560	25.4 × 30	0.15	1.67	EKMM201VSN561MQ30S	
	1,200	25.4 × 45	0.15	2.49	EKMM161VSN122MQ45S	560	30 × 25	0.15	1.67	EKMM201VSN561MR25S	
	1,200	30 × 35	0.15	2.49	EKMM161VSN122MR35S	680	22 × 45	0.15	1.78	EKMM201VSN681MP45S	
	1,200	35 × 30	0.15	2.49	EKMM161VSN122MA30S	680	25.4 × 35	0.15	1.78	EKMM201VSN681MQ35S	
	1,500	25.4 × 60	0.15	2.97	EKMM161VSN152MQ60S	680	30 × 30	0.15	1.78	EKMM201VSN681MR30S	
	1,500	30 × 40	0.15	2.84	EKMM161VSN152MR40S	680	35 × 25	0.15	1.78	EKMM201VSN681MA25S	
	1,500	35 × 30	0.15	2.84	EKMM161VSN152MA30S	820	25.4 × 45	0.15	2.04	EKMM201VSN821MQ45S	
	1,800	30 × 45	0.15	3.32	EKMM161VSN182MR45S	820	30 × 30	0.15	2.04	EKMM201VSN821MR30S	
1,800	35 × 35	0.15	3.00	EKMM161VSN182MA35S	820	35 × 25	0.15	2.04	EKMM201VSN821MA25S		
2,200	30 × 60	0.15	3.86	EKMM161VSN222MR60S	1,000	25.4 × 50	0.15	2.30	EKMM201VSN102MQ50S		
2,200	35 × 45	0.15	3.50	EKMM161VSN222MA45S	1,000	30 × 35	0.15	2.30	EKMM201VSN102MR35S		
2,700	35 × 50	0.15	4.00	EKMM161VSN272MA50S	1,000	35 × 30	0.15	2.30	EKMM201VSN102MA30S		
3,300	35 × 60	0.15	4.63	EKMM161VSN332MA60S	1,200	25.4 × 60	0.15	2.66	EKMM201VSN122MQ60S		
180	180	22 × 20	0.15	0.80	EKMM181VSN181MP20S	1,200	30 × 40	0.15	2.65	EKMM201VSN122MR40S	
	220	25.4 × 20	0.15	0.90	EKMM181VSN221MQ20S	1,200	35 × 35	0.15	2.65	EKMM201VSN122MA35S	
	270	22 × 25	0.15	1.00	EKMM181VSN271MP25S	1,500	30 × 50	0.15	3.08	EKMM201VSN152MR50S	
	270	25.4 × 20	0.15	0.95	EKMM181VSN271MQ20S	1,500	35 × 40	0.15	3.08	EKMM201VSN152MA40S	
	330	22 × 25	0.15	1.20	EKMM181VSN331MP25S	1,800	30 × 60	0.15	3.49	EKMM201VSN182MR60S	
	330	25.4 × 25	0.15	1.16	EKMM181VSN331MQ25S	1,800	35 × 45	0.15	3.48	EKMM201VSN182MA45S	
	330	30 × 20	0.15	1.15	EKMM181VSN331MR20S	2,200	35 × 50	0.15	3.78	EKMM201VSN222MA50S	
	390	22 × 30	0.15	1.35	EKMM181VSN391MP30S	150	22 × 20	0.15	0.67	EKMM221VSN151MP20S	
	390	25.4 × 25	0.15	1.35	EKMM181VSN391MQ25S	180	25.4 × 20	0.15	0.76	EKMM221VSN181MQ20S	
	390	30 × 20	0.15	1.20	EKMM181VSN391MR20S	220	22 × 25	0.15	1.00	EKMM221VSN221MP25S	
	470	22 × 35	0.15	1.50	EKMM181VSN471MP35S	220	25.4 × 20	0.15	0.84	EKMM221VSN221MQ20S	
	470	25.4 × 30	0.15	1.50	EKMM181VSN471MQ30S	270	22 × 30	0.15	1.15	EKMM221VSN271MP30S	
	470	30 × 25	0.15	1.50	EKMM181VSN471MR25S	270	25.4 × 25	0.15	1.08	EKMM221VSN271MQ25S	
	470	35 × 20	0.15	1.36	EKMM181VSN471MA20S	270	30 × 20	0.15	0.98	EKMM221VSN271MR20S	
	560	22 × 40	0.15	1.67	EKMM181VSN561MP40S	330	22 × 35	0.15	1.25	EKMM221VSN331MP35S	
	560	25.4 × 30	0.15	1.67	EKMM181VSN561MQ30S	330	25.4 × 25	0.15	1.25	EKMM221VSN331MQ25S	
	560	30 × 25	0.15	1.67	EKMM181VSN561MR25S	330	35 × 20	0.15	1.13	EKMM221VSN331MA20S	
	560	35 × 20	0.15	1.43	EKMM181VSN561MA20S	390	22 × 35	0.15	1.40	EKMM221VSN391MP35S	
	680	22 × 45	0.15	1.78	EKMM181VSN681MP45S	390	25.4 × 30	0.15	1.40	EKMM221VSN391MQ30S	
	680	25.4 × 35	0.15	1.78	EKMM181VSN681MQ35S	390	30 × 25	0.15	1.36	EKMM221VSN391MR25S	
	680	30 × 30	0.15	1.78	EKMM181VSN681MR30S	390	35 × 20	0.15	1.23	EKMM221VSN391MA20S	
	680	35 × 25	0.15	1.83	EKMM181VSN681MA25S	470	22 × 40	0.15	1.51	EKMM221VSN471MP40S	
	820	22 × 50	0.15	2.04	EKMM181VSN821MP50S	470	25.4 × 35	0.15	1.54	EKMM221VSN471MQ35S	
	820	25.4 × 40	0.15	2.04	EKMM181VSN821MQ40S	470	30 × 25	0.15	1.50	EKMM221VSN471MR25S	
	820	30 × 30	0.15	2.04	EKMM181VSN821MR30S	560	22 × 45	0.15	1.70	EKMM221VSN561MP45S	
	820	35 × 25	0.15	2.04	EKMM181VSN821MA25S	560	25.4 × 40	0.15	1.72	EKMM221VSN561MQ40S	
	1,000	25.4 × 45	0.15	2.30	EKMM181VSN102MQ45S	560	30 × 30	0.15	1.70	EKMM221VSN561MR30S	
	1,000	30 × 35	0.15	2.30	EKMM181VSN102MR35S	560	35 × 25	0.15	1.71	EKMM221VSN561MA25S	
	1,000	35 × 30	0.15	2.30	EKMM181VSN102MA30S	680	25.4 × 45	0.15	1.94	EKMM221VSN681MQ45S	

Return Group Chart



LARGE CAPACITANCE ALUMINUM ELECTROLYTIC CAPACITORS

Long life snap-ins, 105°C

KMM Series

◆ STANDARD RATINGS

WV (V _{dc})	Cap (μF)	Case size φD×L(mm)	tan δ	Rated ripple current (Arms/ 105°C, 120Hz)	Part No.	WV (V _{dc})	Cap (μF)	Case size φD×L(mm)	tan δ	Rated ripple current (Arms/ 105°C, 120Hz)	Part No.
220	680	30 × 35	0.15	1.93	EKMM221VSN681MR35S	315	220	25.4 × 30	0.15	1.04	EKMM3B1VSN221MQ30S
	680	35 × 25	0.15	1.89	EKMM221VSN681MA25S		220	30 × 25	0.15	1.04	EKMM3B1VSN221MR25S
	820	25.4 × 50	0.15	2.18	EKMM221VSN821MQ50S		220	35 × 20	0.15	0.90	EKMM3B1VSN221MA20S
	820	30 × 40	0.15	2.19	EKMM221VSN821MR40S		270	22 × 45	0.15	1.16	EKMM3B1VSN271MP45S
	820	35 × 30	0.15	2.16	EKMM221VSN821MA30S		270	25.4 × 35	0.15	1.16	EKMM3B1VSN271MQ35S
	1,000	25.4 × 60	0.15	2.54	EKMM221VSN102MQ60S		270	30 × 25	0.15	1.16	EKMM3B1VSN271MR25S
	1,000	30 × 45	0.15	2.50	EKMM221VSN102MR45S		270	35 × 25	0.15	1.15	EKMM3B1VSN271MA25S
	1,000	35 × 35	0.15	2.44	EKMM221VSN102MA35S		330	22 × 50	0.15	1.33	EKMM3B1VSN331MP50S
	1,200	30 × 50	0.15	2.81	EKMM221VSN122MR50S		330	25.4 × 40	0.15	1.33	EKMM3B1VSN331MQ40S
	1,200	35 × 40	0.15	2.79	EKMM221VSN122MA40S		330	30 × 30	0.15	1.33	EKMM3B1VSN331MR30S
	1,500	30 × 60	0.15	3.30	EKMM221VSN152MR60S		330	35 × 25	0.15	1.33	EKMM3B1VSN331MA25S
	1,500	35 × 45	0.15	3.22	EKMM221VSN152MA45S		390	25.4 × 45	0.15	1.47	EKMM3B1VSN391MQ45S
	1,800	35 × 50	0.15	3.63	EKMM221VSN182MA50S		390	30 × 35	0.15	1.47	EKMM3B1VSN391MR35S
	2,200	35 × 60	0.15	4.23	EKMM221VSN222MA60S		390	35 × 30	0.15	1.47	EKMM3B1VSN391MA30S
250	120	22 × 20	0.15	0.60	EKMM251VSN121MP20S	470	25.4 × 50	0.15	1.70	EKMM3B1VSN471MQ50S	
	150	25.4 × 20	0.15	0.74	EKMM251VSN151MQ20S	470	30 × 40	0.15	1.70	EKMM3B1VSN471MR40S	
	180	22 × 25	0.15	0.78	EKMM251VSN181MP25S	470	35 × 30	0.15	1.70	EKMM3B1VSN471MA30S	
	180	25.4 × 20	0.15	0.75	EKMM251VSN181MQ20S	560	30 × 45	0.15	2.05	EKMM3B1VSN561MR45S	
	220	22 × 25	0.15	1.00	EKMM251VSN221MP25S	560	35 × 35	0.15	2.05	EKMM3B1VSN561MA35S	
	220	25.4 × 25	0.15	0.95	EKMM251VSN221MQ25S	680	30 × 50	0.15	2.17	EKMM3B1VSN681MR50S	
	220	30 × 20	0.15	0.95	EKMM251VSN221MR20S	680	35 × 40	0.15	2.17	EKMM3B1VSN681MA40S	
	270	22 × 30	0.15	1.18	EKMM251VSN271MP30S	820	35 × 45	0.15	2.20	EKMM3B1VSN821MA45S	
	270	25.4 × 25	0.15	1.18	EKMM251VSN271MQ25S	1,000	35 × 60	0.15	2.55	EKMM3B1VSN102MA60S	
	270	30 × 20	0.15	1.00	EKMM251VSN271MR20S	400	56	22 × 20	0.15	0.41	EKMM351VSN560MP20S
	330	22 × 35	0.15	1.30	EKMM251VSN331MP35S		68	25.4 × 20	0.15	0.46	EKMM351VSN680MQ20S
	330	25.4 × 30	0.15	1.30	EKMM251VSN331MQ30S		82	22 × 25	0.15	0.55	EKMM351VSN820MP25S
	330	30 × 25	0.15	1.30	EKMM251VSN331MR25S		82	25.4 × 20	0.15	0.51	EKMM351VSN820MQ20S
	330	35 × 20	0.15	1.16	EKMM251VSN331MA20S		100	22 × 25	0.15	0.69	EKMM351VSN101MP25S
	390	22 × 40	0.15	1.49	EKMM251VSN391MP40S		100	30 × 20	0.15	0.60	EKMM351VSN101MR20S
	390	25.4 × 35	0.15	1.49	EKMM251VSN391MQ35S		120	22 × 30	0.15	0.75	EKMM351VSN121MP30S
	390	30 × 25	0.15	1.49	EKMM251VSN391MR25S		120	25.4 × 25	0.15	0.75	EKMM351VSN121MQ25S
	470	22 × 45	0.15	1.65	EKMM251VSN471MP45S		120	30 × 20	0.15	0.65	EKMM351VSN121MR20S
	470	25.4 × 35	0.15	1.65	EKMM251VSN471MQ35S		150	22 × 35	0.15	0.82	EKMM351VSN151MP35S
	470	30 × 30	0.15	1.65	EKMM251VSN471MR30S		150	25.4 × 30	0.15	0.83	EKMM351VSN151MQ30S
	470	35 × 25	0.15	1.65	EKMM251VSN471MA25S		150	30 × 25	0.15	0.82	EKMM351VSN151MR25S
	560	22 × 50	0.15	1.67	EKMM251VSN561MP50S		150	35 × 20	0.15	0.76	EKMM351VSN151MA20S
	560	25.4 × 40	0.15	1.80	EKMM251VSN561MQ40S		180	22 × 40	0.15	0.92	EKMM351VSN181MP40S
	560	30 × 30	0.15	1.80	EKMM251VSN561MR30S		180	25.4 × 30	0.15	0.92	EKMM351VSN181MQ30S
	560	35 × 25	0.15	1.80	EKMM251VSN561MA25S		180	30 × 25	0.15	0.90	EKMM351VSN181MR25S
	680	25.4 × 50	0.15	2.00	EKMM251VSN681MQ50S		220	22 × 45	0.15	1.05	EKMM351VSN221MP45S
	680	30 × 35	0.15	2.00	EKMM251VSN681MR35S		220	25.4 × 35	0.15	1.04	EKMM351VSN221MQ35S
	680	35 × 30	0.15	2.00	EKMM251VSN681MA30S		220	30 × 30	0.15	1.02	EKMM351VSN221MR30S
820	25.4 × 60	0.15	2.20	EKMM251VSN821MQ60S	220		35 × 25	0.15	1.04	EKMM351VSN221MA25S	
820	30 × 40	0.15	2.30	EKMM251VSN821MR40S	270		22 × 50	0.15	1.16	EKMM351VSN271MP50S	
820	35 × 35	0.15	2.30	EKMM251VSN821MA35S	270		25.4 × 40	0.15	1.18	EKMM351VSN271MQ40S	
1,000	30 × 50	0.15	2.47	EKMM251VSN102MR50S	270		30 × 30	0.15	1.17	EKMM351VSN271MR30S	
1,000	35 × 40	0.15	2.47	EKMM251VSN102MA40S	270		35 × 25	0.15	1.20	EKMM351VSN271MA25S	
1,200	30 × 60	0.15	2.85	EKMM251VSN122MR60S	330		25.4 × 45	0.15	1.29	EKMM351VSN331MQ45S	
1,200	35 × 45	0.15	2.60	EKMM251VSN122MA45S	330		30 × 35	0.15	1.34	EKMM351VSN331MR35S	
1,500	35 × 50	0.15	3.00	EKMM251VSN152MA50S	330		35 × 30	0.15	1.22	EKMM351VSN331MA30S	
1,800	35 × 60	0.15	3.42	EKMM251VSN182MA60S	390		25.4 × 50	0.15	1.51	EKMM351VSN391MQ50S	
315	68	22 × 20	0.15	0.45	EKMM3B1VSN680MP20S	390	30 × 40	0.15	1.51	EKMM351VSN391MR40S	
	82	22 × 20	0.15	0.47	EKMM3B1VSN820MP20S	390	35 × 35	0.15	1.47	EKMM351VSN391MA35S	
	100	22 × 25	0.15	0.61	EKMM3B1VSN101MP25S	470	25.4 × 60	0.15	1.66	EKMM351VSN471MQ60S	
	100	25.4 × 20	0.15	0.56	EKMM3B1VSN101MQ20S	470	30 × 45	0.15	1.65	EKMM351VSN471MR45S	
	120	22 × 25	0.15	0.75	EKMM3B1VSN121MP25S	470	35 × 35	0.15	1.69	EKMM351VSN471MA35S	
	120	25.4 × 20	0.15	0.62	EKMM3B1VSN121MQ20S	560	30 × 50	0.15	1.85	EKMM351VSN561MR50S	
	120	30 × 20	0.15	0.65	EKMM3B1VSN121MR20S	560	35 × 40	0.15	1.90	EKMM351VSN561MA40S	
	150	22 × 30	0.15	0.82	EKMM3B1VSN151MP30S	680	30 × 60	0.15	2.15	EKMM351VSN681MR60S	
	150	25.4 × 25	0.15	0.82	EKMM3B1VSN151MQ25S	680	35 × 50	0.15	1.99	EKMM351VSN681MA50S	
	150	30 × 20	0.15	0.70	EKMM3B1VSN151MR20S	820	35 × 60	0.15	2.31	EKMM351VSN821MA60S	
	150	35 × 20	0.15	0.76	EKMM3B1VSN151MA20S	47	22 × 20	0.15	0.37	EKMM401VSN470MP20S	
	180	22 × 35	0.15	0.92	EKMM3B1VSN181MP35S	56	25.4 × 20	0.15	0.42	EKMM401VSN560MQ20S	
	180	25.4 × 25	0.15	0.92	EKMM3B1VSN181MQ25S	68	22 × 25	0.15	0.50	EKMM401VSN680MP25S	
	180	30 × 25	0.15	0.90	EKMM3B1VSN181MR25S	68	25.4 × 20	0.15	0.46	EKMM401VSN680MQ20S	
180	35 × 20	0.15	0.85	EKMM3B1VSN181MA20S	82	22 × 25	0.15	0.64	EKMM401VSN820MP25S		
220	22 × 40	0.15	1.04	EKMM3B1VSN221MP40S	82	30 × 20	0.15	0.55	EKMM401VSN820MR20S		

Product specifications in this catalog are subject to change without notice. Request our product specifications before purchase and/or use. Please use our products based on the information contained in this catalog and product specifications.

Return Group Chart



LARGE CAPACITANCE ALUMINUM ELECTROLYTIC CAPACITORS

Long life snap-ins, 105°C

KMM Series

◆ STANDARD RATINGS

WV (V _{dc})	Cap (μF)	Case size φD×L(mm)	tan δ	Rated ripple current (Arms/ 105°C, 120Hz)	Part No.	WV (V _{dc})	Cap (μF)	Case size φD×L(mm)	tan δ	Rated ripple current (Arms/ 105°C, 120Hz)	Part No.	
400	100	22 × 30	0.15	0.70	EKMM401VSN101MP30S	420	180	25.4 × 35	0.20	0.95	EKMM421VSN181MQ35S	
	100	25.4 × 25	0.15	0.70	EKMM401VSN101MQ25S		180	30 × 30	0.20	0.95	EKMM421VSN181MR30S	
	100	30 × 20	0.15	0.60	EKMM401VSN101MR20S		180	35 × 25	0.20	0.94	EKMM421VSN181MA25S	
	120	22 × 35	0.15	0.75	EKMM401VSN121MP35S		220	22 × 50	0.20	1.10	EKMM421VSN221MP50S	
	120	25.4 × 25	0.15	0.75	EKMM401VSN121MQ25S		220	25.4 × 45	0.20	1.10	EKMM421VSN221MQ45S	
	120	30 × 25	0.15	0.73	EKMM401VSN121MR25S		220	30 × 35	0.20	1.10	EKMM421VSN221MR35S	
	120	35 × 20	0.15	0.75	EKMM401VSN121MA20S		220	35 × 25	0.20	1.10	EKMM421VSN221MA25S	
	150	22 × 40	0.15	0.88	EKMM401VSN151MP40S		270	25.4 × 50	0.20	1.22	EKMM421VSN271MQ50S	
	150	25.4 × 30	0.15	0.88	EKMM401VSN151MQ30S		270	30 × 40	0.20	1.22	EKMM421VSN271MR40S	
	150	30 × 25	0.15	0.88	EKMM401VSN151MR25S		270	35 × 30	0.20	1.22	EKMM421VSN271MA30S	
	150	35 × 20	0.15	0.80	EKMM401VSN151MA20S		330	25.4 × 60	0.20	1.41	EKMM421VSN331MQ60S	
	180	22 × 45	0.15	0.98	EKMM401VSN181MP45S		330	30 × 45	0.20	1.45	EKMM421VSN331MR45S	
	180	25.4 × 35	0.15	0.98	EKMM401VSN181MQ35S		330	35 × 35	0.20	1.45	EKMM421VSN331MA35S	
	180	30 × 30	0.15	0.98	EKMM401VSN181MR30S		390	30 × 50	0.20	1.55	EKMM421VSN391MR50S	
	180	35 × 25	0.15	0.98	EKMM401VSN181MA25S		390	35 × 40	0.20	1.55	EKMM421VSN391MA40S	
	220	22 × 50	0.15	1.10	EKMM401VSN221MP50S		470	30 × 60	0.20	1.79	EKMM421VSN471MR60S	
	220	25.4 × 40	0.15	1.10	EKMM401VSN221MQ40S		470	35 × 45	0.20	1.90	EKMM421VSN471MA45S	
	220	30 × 30	0.15	1.10	EKMM401VSN221MR30S		560	35 × 50	0.20	2.15	EKMM421VSN561MA50S	
	220	35 × 25	0.15	1.10	EKMM401VSN221MA25S		680	35 × 60	0.20	2.27	EKMM421VSN681MA60S	
	270	25.4 × 45	0.15	1.22	EKMM401VSN271MQ45S		450	56	22 × 25	0.20	0.40	EKMM451VSN560MP25S
	270	30 × 35	0.15	1.22	EKMM401VSN271MR35S			68	22 × 30	0.20	0.53	EKMM451VSN680MP30S
	270	35 × 30	0.15	1.22	EKMM401VSN271MA30S			68	25.4 × 25	0.20	0.50	EKMM451VSN680MQ25S
	330	25.4 × 50	0.15	1.44	EKMM401VSN331MQ50S			82	22 × 30	0.20	0.64	EKMM451VSN820MP30S
	330	30 × 40	0.15	1.44	EKMM401VSN331MR40S			82	25.4 × 25	0.20	0.64	EKMM451VSN820MQ25S
	330	35 × 30	0.15	1.44	EKMM401VSN331MA30S			100	22 × 35	0.20	0.69	EKMM451VSN101MP35S
	390	25.4 × 60	0.15	1.51	EKMM401VSN391MQ60S			100	25.4 × 30	0.20	0.69	EKMM451VSN101MQ30S
390	30 × 45	0.15	1.60	EKMM401VSN391MR45S	100	30 × 25		0.20	0.64	EKMM451VSN101MR25S		
390	35 × 35	0.15	1.60	EKMM401VSN391MA35S	120	22 × 40		0.20	0.80	EKMM451VSN121MP40S		
470	30 × 50	0.15	1.90	EKMM401VSN471MR50S	120	25.4 × 30		0.20	0.80	EKMM451VSN121MQ30S		
470	35 × 40	0.15	1.90	EKMM401VSN471MA40S	120	30 × 25		0.20	0.80	EKMM451VSN121MR25S		
560	30 × 60	0.15	2.10	EKMM401VSN561MR60S	120	35 × 25		0.20	0.73	EKMM451VSN121MA25S		
560	35 × 45	0.15	2.12	EKMM401VSN561MA45S	150	22 × 45		0.20	0.88	EKMM451VSN151MP45S		
680	35 × 60	0.15	2.27	EKMM401VSN681MA60S	150	25.4 × 35		0.20	0.88	EKMM451VSN151MQ35S		
420	47	22 × 20	0.20	0.37	EKMM421VSN470MP20S	150		30 × 30	0.20	0.88	EKMM451VSN151MR30S	
	56	25.4 × 20	0.20	0.42	EKMM421VSN560MQ20S	150		35 × 25	0.20	0.75	EKMM451VSN151MA25S	
	68	22 × 25	0.20	0.50	EKMM421VSN680MP25S	180		22 × 50	0.20	1.00	EKMM451VSN181MP50S	
	68	25.4 × 20	0.20	0.46	EKMM421VSN680MQ20S	180		25.4 × 40	0.20	1.00	EKMM451VSN181MQ40S	
	82	22 × 25	0.20	0.64	EKMM421VSN820MP25S	180		30 × 30	0.20	1.00	EKMM451VSN181MR30S	
	82	25.4 × 25	0.20	0.58	EKMM421VSN820MQ25S	220		25.4 × 45	0.20	1.12	EKMM451VSN221MQ45S	
	82	30 × 20	0.20	0.53	EKMM421VSN820MR20S	220		30 × 35	0.20	1.12	EKMM451VSN221MR35S	
	100	22 × 30	0.20	0.70	EKMM421VSN101MP30S	220		35 × 30	0.20	1.12	EKMM451VSN221MA30S	
	100	25.4 × 25	0.20	0.70	EKMM421VSN101MQ25S	270		25.4 × 60	0.20	1.18	EKMM451VSN271MQ60S	
	100	30 × 20	0.20	0.59	EKMM421VSN101MR20S	270		30 × 40	0.20	1.28	EKMM451VSN271MR40S	
	120	22 × 35	0.20	0.75	EKMM421VSN121MP35S	270		35 × 35	0.20	1.28	EKMM451VSN271MA35S	
	120	25.4 × 30	0.20	0.75	EKMM421VSN121MQ30S	330		30 × 50	0.20	1.45	EKMM451VSN331MR50S	
	120	30 × 25	0.20	0.73	EKMM421VSN121MR25S	330	35 × 40	0.20	1.45	EKMM451VSN331MA40S		
	120	35 × 20	0.20	0.67	EKMM421VSN121MA20S	390	30 × 60	0.20	1.51	EKMM451VSN391MR60S		
	150	22 × 40	0.20	0.88	EKMM421VSN151MP40S	390	35 × 40	0.20	1.55	EKMM451VSN391MA40S		
	150	25.4 × 35	0.20	0.88	EKMM421VSN151MQ35S	470	35 × 50	0.20	1.85	EKMM451VSN471MA50S		
	150	30 × 25	0.20	0.88	EKMM421VSN151MR25S	560	35 × 60	0.20	1.91	EKMM451VSN561MA60S		
	180	22 × 45	0.20	0.95	EKMM421VSN181MP45S							

◆ STANDARD RATINGS RATED RIPPLE CURRENT MULTIPLIERS

● Frequency Multipliers

Frequency(Hz)	50	120	300	1k	10k	50k
160 to 250V _{dc}	0.81	1.00	1.17	1.32	1.45	1.50
315 to 450V _{dc}	0.77	1.00	1.16	1.30	1.41	1.43

The endurance of capacitors is reduced with internal heating produced by ripple current at the rate of halving the lifetime with every 5°C rise. When long life performance is required in actual use, the rms ripple current has to be reduced.

Return Group Chart



LARGE CAPACITANCE ALUMINUM ELECTROLYTIC CAPACITORS

Standard snap-ins, 85°C

SMH Series

- Endurance with ripple current : 2,000 hours at 85°C
- Non solvent resistant type
- RoHS Compliant

SMM P251
↓
Downsized
Longer life

SMH



◆ SPECIFICATIONS

Items	Characteristics										
Category	-40 to +85°C										
Temperature Range											
Rated Voltage Range	6.3 to 100V _{dc}										
Capacitance Tolerance	±20% (M) (at 20°C, 120Hz)										
Leakage Current	I=0.02CV or 3mA, whichever is smaller. Where, I : Max. leakage current (μA), C : Nominal capacitance (μF), V : Rated voltage (V) (at 20°C after 5 minutes)										
Dissipation Factor (tan δ)	Rated voltage (V _{dc})	6.3V	10V	16V	25V	35V	50V	63V	80V	100V	
	tan δ (Max.)	0.60	0.50	0.40	0.30	0.25	0.20	0.15	0.15	0.15	(at 20°C, 120Hz)
Low Temperature Characteristics (Max. Impedance Ratio)	Rated voltage (V _{dc})	6.3V	10V	16V	25V	35V	50V	63V	80V	100V	
	Z(-25°C)/Z(+20°C)	4	4	4	3	3	2	2	2	2	
	Z(-40°C)/Z(+20°C)	15	15	15	10	8	6	6	5	5	(at 120Hz)
Endurance	The following specifications shall be satisfied when the capacitors are restored to 20°C after subjected to DC voltage with the rated ripple current is applied (the peak voltage shall not exceed the rated voltage) for 2,000 hours at 85°C.										
	Capacitance change	≤ ±20% of the initial value									
	D.F. (tan δ)	≤ 200% of the initial specified value									
	Leakage current	≤ The initial specified value									
Shelf Life	The following specifications shall be satisfied when the capacitors are restored to 20°C after exposing them for 1,000 hours at 85°C without voltage applied. Before the measurement, the capacitor shall be preconditioned by applying voltage according to Item 4.1 of JIS C 5101-4.										
	Capacitance change	≤ ±20% of the initial value									
	D.F. (tan δ)	≤ 150% of the initial specified value									
	Leakage current	≤ The initial specified value									

◆ DIMENSIONS [mm]

● Terminal Code : VS (φ22 to φ35) : Standard

● Terminal Code : LI (φ35)

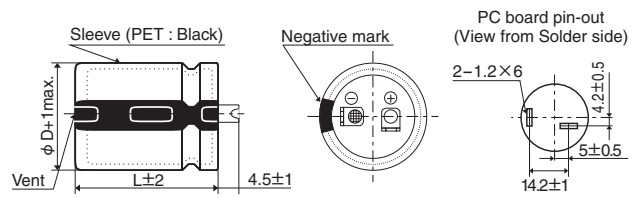
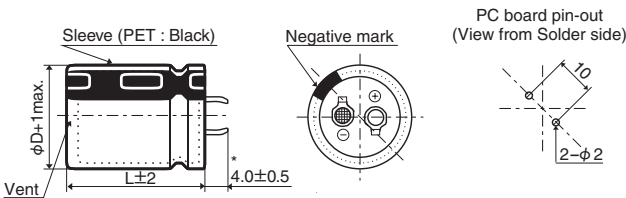

*φD=35mm : 3.5±0.5mm

The standard design has no plastic disc.

◆ PART NUMBERING SYSTEM

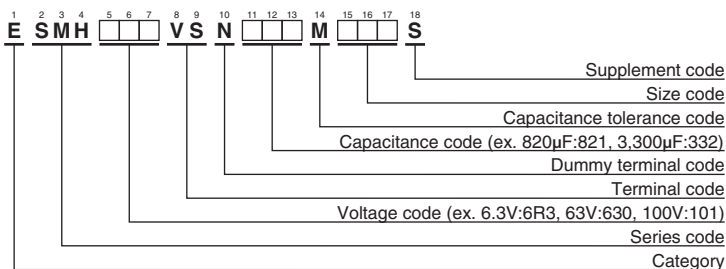

Please refer to "Product code guide (snap-in type)"

Return Group Chart



LARGE CAPACITANCE ALUMINUM ELECTROLYTIC CAPACITORS

Standard snap-ins, 85°C

SMH

Series

◆STANDARD RATINGS

WV (V _{dc})	Cap (μF)	Case size φD×L(mm)	tan δ	Rated ripple current (Arms/85°C, 120Hz)	Part No.	WV (V _{dc})	Cap (μF)	Case size φD×L(mm)	tan δ	Rated ripple current (Arms/85°C, 120Hz)	Part No.		
6.3	15,000	22 × 25	0.60	2.44	ESMH6R3VSN153MP25S	16	27,000	25.4 × 45	0.40	4.72	ESMH160VSN273MQ45S		
	18,000	22 × 30	0.60	2.67	ESMH6R3VSN183MP30S		27,000	30 × 35	0.40	4.82	ESMH160VSN273MR35S		
	18,000	25.4 × 25	0.60	2.70	ESMH6R3VSN183MQ25S		27,000	35 × 30	0.40	4.65	ESMH160VSN273MA30S		
	22,000	22 × 30	0.60	3.06	ESMH6R3VSN223MP30S		33,000	25.4 × 50	0.40	5.33	ESMH160VSN333MQ50S		
	22,000	25.4 × 25	0.60	3.07	ESMH6R3VSN223MQ25S		33,000	30 × 40	0.40	5.36	ESMH160VSN333MR40S		
	27,000	22 × 35	0.60	3.49	ESMH6R3VSN273MP35S		33,000	35 × 30	0.40	5.15	ESMH160VSN333MA30S		
	27,000	25.4 × 30	0.60	3.52	ESMH6R3VSN273MQ30S		39,000	30 × 45	0.40	6.01	ESMH160VSN393MR45S		
	27,000	30 × 25	0.60	3.57	ESMH6R3VSN273MR25S		39,000	35 × 35	0.40	5.95	ESMH160VSN393MA35S		
	33,000	22 × 40	0.60	3.97	ESMH6R3VSN333MP40S		47,000	30 × 50	0.40	6.79	ESMH160VSN473MR50S		
	33,000	25.4 × 35	0.60	4.02	ESMH6R3VSN333MQ35S		47,000	35 × 40	0.40	6.76	ESMH160VSN473MA40S		
	33,000	30 × 25	0.60	3.95	ESMH6R3VSN333MQ25S		56,000	35 × 45	0.40	7.62	ESMH160VSN563MA45S		
	39,000	22 × 50	0.60	4.55	ESMH6R3VSN393MP50S		68,000	35 × 50	0.40	8.63	ESMH160VSN683MA50S		
	39,000	25.4 × 40	0.60	4.50	ESMH6R3VSN393MQ40S		25	5,600	22 × 25	0.30	2.21	ESMH250VSN562MP25S	
	39,000	30 × 30	0.60	4.45	ESMH6R3VSN393MR30S			6,800	22 × 30	0.30	2.40	ESMH250VSN682MP30S	
	39,000	35 × 25	0.60	4.51	ESMH6R3VSN393MA25S			6,800	25.4 × 25	0.30	2.56	ESMH250VSN682MQ25S	
	47,000	25.4 × 45	0.60	5.09	ESMH6R3VSN473MQ45S			8,200	22 × 35	0.30	2.72	ESMH250VSN822MP35S	
	47,000	30 × 35	0.60	5.06	ESMH6R3VSN473MR35S			8,200	25.4 × 25	0.30	2.80	ESMH250VSN822MQ25S	
	47,000	35 × 30	0.60	5.01	ESMH6R3VSN473MA30S			10,000	22 × 40	0.30	3.09	ESMH250VSN103MP40S	
	56,000	25.4 × 50	0.60	5.71	ESMH6R3VSN563MQ50S			10,000	25.4 × 30	0.30	3.12	ESMH250VSN103MQ30S	
	56,000	30 × 40	0.60	5.70	ESMH6R3VSN563MR40S			10,000	30 × 25	0.30	3.21	ESMH250VSN103MR25S	
	56,000	35 × 30	0.60	5.77	ESMH6R3VSN563MA30S			12,000	22 × 45	0.30	3.48	ESMH250VSN123MP45S	
	68,000	30 × 45	0.60	6.48	ESMH6R3VSN683MR45S			12,000	25.4 × 35	0.30	3.43	ESMH250VSN123MQ35S	
	68,000	35 × 35	0.60	6.42	ESMH6R3VSN683MA35S			12,000	30 × 30	0.30	3.86	ESMH250VSN123MR30S	
	82,000	30 × 50	0.60	7.32	ESMH6R3VSN823MR50S			12,000	35 × 25	0.30	3.54	ESMH250VSN123MA25S	
	82,000	35 × 40	0.60	7.29	ESMH6R3VSN823MA40S			15,000	22 × 50	0.30	4.00	ESMH250VSN153MP50S	
	100,000	35 × 45	0.60	8.31	ESMH6R3VSN104MA45S			15,000	25.4 × 40	0.30	3.95	ESMH250VSN153MQ40S	
	10	12,000	22 × 25	0.50	2.39			ESMH100VSN123MP25S	15,000	30 × 30	0.30	4.00	ESMH250VSN153MR30S
		15,000	22 × 30	0.50	2.76			ESMH100VSN153MP30S	15,000	35 × 25	0.30	3.95	ESMH250VSN153MA25S
15,000		25.4 × 25	0.50	2.77	ESMH100VSN153MQ25S	18,000		25.4 × 45	0.30	4.45	ESMH250VSN183MQ45S		
18,000		22 × 35	0.50	3.12	ESMH100VSN183MP35S	18,000		30 × 35	0.30	4.46	ESMH250VSN183MR35S		
18,000		25.4 × 25	0.50	3.04	ESMH100VSN183MQ25S	18,000	35 × 30	0.30	4.63	ESMH250VSN183MA30S			
22,000		22 × 40	0.50	3.55	ESMH100VSN223MP40S	22,000	25.4 × 50	0.30	5.02	ESMH250VSN223MQ50S			
22,000		25.4 × 30	0.50	3.48	ESMH100VSN223MQ30S	22,000	30 × 45	0.30	5.21	ESMH250VSN223MR45S			
22,000		30 × 25	0.50	3.53	ESMH100VSN223MR25S	22,000	35 × 35	0.30	5.16	ESMH250VSN223MA35S			
27,000		22 × 45	0.50	4.04	ESMH100VSN273MP45S	27,000	30 × 50	0.30	5.94	ESMH250VSN273MR50S			
27,000		25.4 × 35	0.50	3.98	ESMH100VSN273MQ35S	27,000	35 × 40	0.30	5.92	ESMH250VSN273MA40S			
27,000		30 × 30	0.50	3.73	ESMH100VSN273MR30S	33,000	35 × 45	0.30	6.75	ESMH250VSN333MA45S			
27,000		35 × 25	0.50	3.73	ESMH100VSN273MA25S	39,000	35 × 50	0.30	7.56	ESMH250VSN393MA50S			
33,000		22 × 50	0.50	4.58	ESMH100VSN333MP50S	35	3,900	22 × 25	0.25	2.22	ESMH350VSN392MP25S		
33,000		25.4 × 40	0.50	4.54	ESMH100VSN333MQ40S		4,700	22 × 30	0.25	2.41	ESMH350VSN472MP30S		
33,000		30 × 30	0.50	4.13	ESMH100VSN333MR30S		4,700	25.4 × 25	0.25	2.42	ESMH350VSN472MQ25S		
33,000		35 × 25	0.50	4.13	ESMH100VSN333MA25S		5,600	22 × 35	0.25	2.75	ESMH350VSN562MP35S		
39,000		25.4 × 45	0.50	5.08	ESMH100VSN393MQ45S		5,600	25.4 × 25	0.25	2.64	ESMH350VSN562MQ25S		
39,000		30 × 35	0.50	5.05	ESMH100VSN393MR35S		6,800	22 × 40	0.25	2.80	ESMH350VSN682MP40S		
39,000		35 × 30	0.50	4.80	ESMH100VSN393MA30S		6,800	25.4 × 30	0.25	2.74	ESMH350VSN682MQ30S		
47,000		25.4 × 50	0.50	5.73	ESMH100VSN473MQ50S		6,800	30 × 25	0.25	2.97	ESMH350VSN682MR25S		
47,000		30 × 40	0.50	5.72	ESMH100VSN473MR40S		8,200	22 × 45	0.25	3.47	ESMH350VSN822MP45S		
47,000		35 × 30	0.50	5.27	ESMH100VSN473MA30S		8,200	25.4 × 35	0.25	3.10	ESMH350VSN822MQ35S		
56,000		30 × 45	0.50	6.44	ESMH100VSN563MR45S		8,200	30 × 30	0.25	3.13	ESMH350VSN822MR30S		
56,000		35 × 35	0.50	6.38	ESMH100VSN563MA35S		8,200	35 × 25	0.25	2.73	ESMH350VSN822MA25S		
68,000		30 × 50	0.50	7.27	ESMH100VSN683MR50S		10,000	22 × 50	0.25	3.57	ESMH350VSN103MP50S		
68,000		35 × 40	0.50	7.27	ESMH100VSN683MA40S		10,000	25.4 × 40	0.25	3.53	ESMH350VSN103MQ40S		
82,000		35 × 50	0.50	8.49	ESMH100VSN823MA50S		10,000	30 × 30	0.25	3.46	ESMH350VSN103MR30S		
16		8,200	22 × 25	0.40	2.51		ESMH160VSN822MP25S	10,000	35 × 25	0.25	3.02	ESMH350VSN103MA25S	
	10,000	22 × 25	0.40	2.77	ESMH160VSN103MP25S		12,000	25.4 × 45	0.25	3.98	ESMH350VSN123MQ45S		
	12,000	22 × 30	0.40	2.86	ESMH160VSN103MP30S		12,000	30 × 35	0.25	4.01	ESMH350VSN123MR35S		
	12,000	25.4 × 25	0.40	2.95	ESMH160VSN123MQ25S	12,000	35 × 30	0.25	4.42	ESMH350VSN123MA30S			
	15,000	22 × 35	0.40	3.29	ESMH160VSN153MP35S	15,000	25.4 × 50	0.25	4.54	ESMH350VSN153MQ50S			
	15,000	25.4 × 30	0.40	3.46	ESMH160VSN153MQ30S	15,000	30 × 40	0.25	4.52	ESMH350VSN153MR40S			
	15,000	30 × 25	0.40	3.66	ESMH160VSN153MR25S	15,000	35 × 35	0.25	5.01	ESMH350VSN153MA35S			
	18,000	22 × 40	0.40	3.72	ESMH160VSN183MP40S	18,000	30 × 45	0.25	4.71	ESMH350VSN183MR45S			
	18,000	25.4 × 35	0.40	3.98	ESMH160VSN183MQ35S	18,000	35 × 40	0.25	5.54	ESMH350VSN183MA40S			
	18,000	30 × 25	0.40	4.00	ESMH160VSN183MR25S	22,000	30 × 50	0.25	5.33	ESMH350VSN223MR50S			
	22,000	22 × 50	0.40	4.37	ESMH160VSN223MP50S	22,000	35 × 45	0.25	6.04	ESMH350VSN223MA45S			
	22,000	25.4 × 40	0.40	4.26	ESMH160VSN223MQ40S	27,000	35 × 50	0.25	6.89	ESMH350VSN273MA50S			
	22,000	30 × 30	0.40	4.21	ESMH160VSN223MR30S	50	2,200	22 × 25	0.20	1.91	ESMH500VSN222MP25S		
	22,000	35 × 25	0.40	4.15	ESMH160VSN223MA25S		3,300	22 × 30	0.20	2.37	ESMH500VSN332MP30S		

Product specifications in this catalog are subject to change without notice. Request our product specifications before purchase and/or use. Please use our products based on the information contained in this catalog and product specifications.

Return Group Chart



LARGE CAPACITANCE ALUMINUM ELECTROLYTIC CAPACITORS

Standard snap-ins, 85°C



◆STANDARD RATINGS

WV (V _{dc})	Cap (μF)	Case size φD×L(mm)	tan δ	Rated ripple current (Arms/ 85°C, 120Hz)	Part No.	WV (V _{dc})	Cap (μF)	Case size φD×L(mm)	tan δ	Rated ripple current (Arms/ 85°C, 120Hz)	Part No.
50	3,300	25.4 × 25	0.20	2.38	ESMH500VSN332MQ25S	80	1,200	22 × 25	0.15	1.69	ESMH800VSN122MP25S
	3,900	22 × 35	0.20	2.65	ESMH500VSN392MP35S		1,500	22 × 25	0.15	1.88	ESMH800VSN152MP25S
	3,900	25.4 × 30	0.20	2.68	ESMH500VSN392MQ30S		1,800	22 × 30	0.15	2.14	ESMH800VSN182MP30S
	3,900	30 × 25	0.20	2.55	ESMH500VSN392MR25S		1,800	25.4 × 25	0.15	2.26	ESMH800VSN182MQ25S
	4,700	22 × 40	0.20	2.99	ESMH500VSN472MP40S		2,200	22 × 35	0.15	2.44	ESMH800VSN222MP35S
	4,700	25.4 × 35	0.20	3.03	ESMH500VSN472MQ35S		2,200	25.4 × 30	0.15	2.46	ESMH800VSN222MQ30S
	4,700	30 × 25	0.20	2.81	ESMH500VSN472MR25S		2,200	30 × 25	0.15	2.49	ESMH800VSN222MR25S
	5,600	22 × 45	0.20	3.36	ESMH500VSN562MP45S		2,700	22 × 40	0.15	2.78	ESMH800VSN272MP40S
	5,600	25.4 × 35	0.20	3.31	ESMH500VSN562MQ35S		2,700	25.4 × 35	0.15	2.81	ESMH800VSN272MQ35S
	5,600	30 × 30	0.20	3.37	ESMH500VSN562MR30S		2,700	30 × 25	0.15	2.75	ESMH800VSN272MR25S
	5,600	35 × 25	0.20	3.42	ESMH500VSN562MA25S		3,300	22 × 45	0.15	3.16	ESMH800VSN332MP45S
	6,800	22 × 50	0.20	3.81	ESMH500VSN682MP50S		3,300	25.4 × 40	0.15	3.21	ESMH800VSN332MQ40S
	6,800	25.4 × 40	0.20	3.81	ESMH500VSN682MQ40S		3,300	30 × 30	0.15	3.17	ESMH800VSN332MR30S
	6,800	30 × 35	0.20	3.85	ESMH500VSN682MR35S		3,300	35 × 25	0.15	3.21	ESMH800VSN332MA25S
	6,800	35 × 30	0.20	3.85	ESMH500VSN682MA30S		3,900	22 × 50	0.15	3.52	ESMH800VSN392MP50S
	8,200	25.4 × 50	0.20	4.37	ESMH500VSN822MQ50S		3,900	25.4 × 45	0.15	3.59	ESMH800VSN392MQ45S
	8,200	30 × 40	0.20	4.36	ESMH500VSN822MR40S		3,900	30 × 35	0.15	3.57	ESMH800VSN392MR35S
	8,200	35 × 30	0.20	4.41	ESMH500VSN822MA30S		3,900	35 × 25	0.15	3.50	ESMH800VSN392MA25S
10,000	30 × 45	0.20	4.97	ESMH500VSN103MR45S	4,700	25.4 × 50	0.15	4.05	ESMH800VSN472MQ50S		
10,000	35 × 35	0.20	4.92	ESMH500VSN103MA35S	4,700	30 × 40	0.15	4.05	ESMH800VSN472MR40S		
12,000	30 × 50	0.20	5.60	ESMH500VSN123MR50S	4,700	35 × 30	0.15	4.09	ESMH800VSN472MA30S		
12,000	35 × 40	0.20	5.58	ESMH500VSN123MA40S	5,600	30 × 45	0.15	4.55	ESMH800VSN562MR45S		
15,000	35 × 45	0.20	6.44	ESMH500VSN153MA45S	5,600	35 × 35	0.15	4.51	ESMH800VSN562MA35S		
18,000	35 × 50	0.20	6.71	ESMH500VSN183MA50S	6,800	30 × 50	0.15	5.16	ESMH800VSN682MR50S		
63	1,800	22 × 25	0.15	1.82	ESMH630VSN182MP25S	6,800	35 × 40	0.15	5.14	ESMH800VSN682MA40S	
	2,200	22 × 30	0.15	2.31	ESMH630VSN222MP30S	8,200	35 × 45	0.15	5.83	ESMH800VSN822MA45S	
	2,200	25.4 × 25	0.15	2.30	ESMH630VSN222MQ25S	10,000	35 × 50	0.15	6.63	ESMH800VSN103MA50S	
	2,700	22 × 35	0.15	2.40	ESMH630VSN272MP35S	100	820	22 × 25	0.15	1.86	ESMH101VSN821MP25S
	2,700	25.4 × 25	0.15	2.40	ESMH630VSN272MQ25S		1,200	22 × 30	0.15	2.09	ESMH101VSN122MP30S
	3,300	22 × 35	0.15	2.62	ESMH630VSN332MP35S		1,200	25.4 × 25	0.15	2.10	ESMH101VSN122MQ25S
	3,300	25.4 × 30	0.15	2.64	ESMH630VSN332MQ30S		1,500	22 × 35	0.15	2.41	ESMH101VSN152MP35S
	3,300	30 × 25	0.15	2.78	ESMH630VSN332MR25S		1,500	25.4 × 30	0.15	2.43	ESMH101VSN152MQ30S
	3,900	22 × 40	0.15	2.93	ESMH630VSN392MP40S		1,500	30 × 25	0.15	2.46	ESMH101VSN152MR25S
	3,900	25.4 × 35	0.15	2.97	ESMH630VSN392MQ35S		1,800	22 × 40	0.15	2.71	ESMH101VSN182MP40S
	3,900	30 × 30	0.15	3.00	ESMH630VSN392MR30S		1,800	25.4 × 35	0.15	2.75	ESMH101VSN182MQ35S
	3,900	35 × 25	0.15	3.00	ESMH630VSN392MA25S		1,800	30 × 25	0.15	2.72	ESMH101VSN182MR25S
	4,700	22 × 50	0.15	3.39	ESMH630VSN472MP50S		2,200	22 × 45	0.15	3.08	ESMH101VSN222MP45S
	4,700	25.4 × 40	0.15	3.36	ESMH630VSN472MQ40S		2,200	25.4 × 40	0.15	3.13	ESMH101VSN222MQ40S
	4,700	30 × 30	0.15	3.32	ESMH630VSN472MR30S		2,200	30 × 30	0.15	3.09	ESMH101VSN222MR30S
	4,700	35 × 25	0.15	3.36	ESMH630VSN472MA25S		2,200	35 × 25	0.15	3.14	ESMH101VSN222MA25S
	5,600	25.4 × 45	0.15	3.77	ESMH630VSN562MQ45S		2,700	22 × 50	0.15	3.53	ESMH101VSN272MP50S
	5,600	30 × 35	0.15	3.75	ESMH630VSN562MR35S		2,700	25.4 × 45	0.15	3.57	ESMH101VSN272MQ45S
5,600	35 × 30	0.15	3.76	ESMH630VSN562MA30S	2,700		30 × 35	0.15	3.55	ESMH101VSN272MR35S	
6,800	25.4 × 50	0.15	4.27	ESMH630VSN682MQ50S	2,700		35 × 30	0.15	3.71	ESMH101VSN272MA30S	
6,800	30 × 40	0.15	4.27	ESMH630VSN682MR40S	3,300		25.4 × 50	0.15	4.06	ESMH101VSN332MQ50S	
6,800	35 × 30	0.15	4.15	ESMH630VSN682MA30S	3,300	30 × 40	0.15	4.05	ESMH101VSN332MR40S		
8,200	30 × 45	0.15	4.83	ESMH630VSN822MR45S	3,300	35 × 30	0.15	4.05	ESMH101VSN332MA30S		
8,200	35 × 35	0.15	4.79	ESMH630VSN822MA35S	3,900	30 × 45	0.15	4.54	ESMH101VSN392MR45S		
10,000	30 × 50	0.15	5.49	ESMH630VSN103MR50S	3,900	35 × 35	0.15	4.49	ESMH101VSN392MA35S		
10,000	35 × 40	0.15	5.47	ESMH630VSN103MA40S	4,700	30 × 50	0.15	5.13	ESMH101VSN472MR50S		
12,000	35 × 45	0.15	6.19	ESMH630VSN123MA45S	4,700	35 × 40	0.15	5.11	ESMH101VSN472MA40S		
					5,600	35 × 45	0.15	5.75	ESMH101VSN562MA45S		
					6,800	35 × 50	0.15	6.50	ESMH101VSN682MA50S		

*For the rated voltage $\geq 160V_{dc}$, please use SMQ series

◆RATED RIPPLE CURRENT MULTIPLIERS

● Frequency Multipliers

Frequency(Hz)	50	120	300	1k	10k	50k
6.3 to 50V _{dc}	0.95	1.00	1.03	1.05	1.08	1.08
63 to 100V _{dc}	0.92	1.00	1.07	1.13	1.19	1.20

The endurance of capacitors is reduced with internal heating produced by ripple current at the rate of halving the lifetime with every 5°C rise. When long life performance is required in actual use, the rms ripple current has to be reduced.

Return Group Chart



LARGE CAPACITANCE ALUMINUM ELECTROLYTIC CAPACITORS

Standard snap-ins, 105°C

KMH Series

- Endurance with ripple current : 2,000 hours at 105°C
- Non solvent resistant type
- RoHS Compliant

KMM P260

Downsized
Longer life

KMH



◆ SPECIFICATIONS

Items	Characteristics										
Category	-40 to +105°C										
Temperature Range											
Rated Voltage Range	6.3 to 100V _{dc}										
Capacitance Tolerance	±20% (M) (at 20°C, 120Hz)										
Leakage Current	I=0.02CV or 3mA, whichever is smaller Where, I : Max. leakage current (µA), C : Nominal capacitance (µF), V : Rated voltage (V) (at 20°C after 5 minutes)										
Dissipation Factor (tan δ)	Rated voltage (V _{dc})	6.3V	10V	16V	25V	35V	50V	63V	80V	100V	
	tan δ (Max.)	0.60	0.50	0.40	0.30	0.25	0.20	0.15	0.15	0.15	(at 20°C, 120Hz)
Low Temperature Characteristics (Max. Impedance Ratio)	Rated voltage (V _{dc})	6.3V	10V	16V	25V	35V	50V	63V	80V	100V	
	Z(-25°C)/Z(+20°C)	4	4	4	3	3	2	2	2	2	
	Z(-45°C)/Z(+20°C)	15	15	15	10	8	6	6	5	5	(at 120Hz)
Endurance	The following specifications shall be satisfied when the capacitors are restored to 20°C after subjected to DC voltage with the rated ripple current is applied (the peak voltage shall not exceed the rated voltage) for 2,000 hours at 105°C										
	Capacitance change	≤ ±20% of the initial value									
	D.F. (tan δ)	≤ 200% of the initial specified value									
	Leakage current	≤ The initial specified value									
Shelf Life	The following specifications shall be satisfied when the capacitors are restored to 20°C after exposing them for 1,000 hours at 105°C without voltage applied. Before the measurement, the capacitor shall be preconditioned by applying voltage according to Item 4.1 of JIS C 5101-4.										
	Capacitance change	≤ ±20% of the initial value									
	D.F. (tan δ)	≤ 150% of the initial specified value									
	Leakage current	≤ The initial specified value									

◆ DIMENSIONS [mm]

● Terminal Code : VS (φ22 to φ35) : Standard

● Terminal Code : LI (φ35)

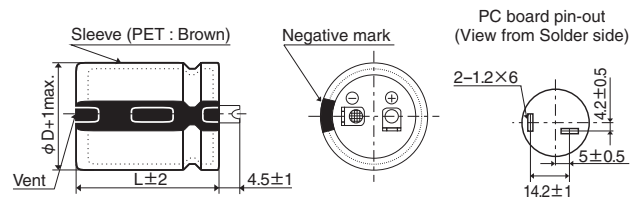
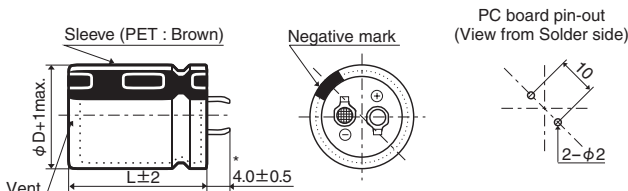

* φD=35mm : 3.5±0.5mm

The standard design has no plastic disc.

◆ PART NUMBERING SYSTEM

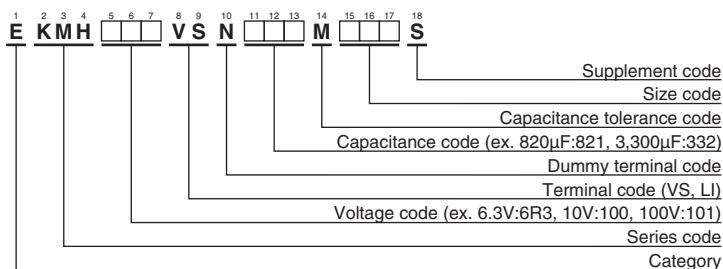

Please refer to "Product code guide (snap-in type)"

Return Group Chart



LARGE CAPACITANCE ALUMINUM ELECTROLYTIC CAPACITORS

Standard snap-ins, 105°C



STANDARD RATINGS

WV (V _{dc})	Cap (μ F)	Case size ϕ D \times L(mm)	tan δ	Rated ripple current (Arms/ 105°C, 120Hz)		Part No.	WV (V _{dc})	Cap (μ F)	Case size ϕ D \times L(mm)	tan δ	Rated ripple current (Arms/ 105°C, 120Hz)		Part No.
				Arms/ 105°C, 120Hz	Part No.						Arms/ 105°C, 120Hz	Part No.	
6.3	12,000	22 × 25	0.60	1.54	EKMH6R3VSN123MP25S	16	27,000	35 × 30	0.40	3.45	EKMH160VSN273MA30S		
	15,000	22 × 25	0.60	1.72	EKMH6R3VSN153MP25S		33,000	30 × 45	0.40	4.30	EKMH160VSN333MR45S		
	18,000	22 × 30	0.60	1.95	EKMH6R3VSN183MP30S		33,000	35 × 35	0.40	4.26	EKMH160VSN333MA35S		
	18,000	25.4 × 25	0.60	1.96	EKMH6R3VSN183MQ25S		39,000	30 × 50	0.40	4.81	EKMH160VSN393MR50S		
	22,000	22 × 35	0.60	2.23	EKMH6R3VSN223MP35S		39,000	35 × 40	0.40	4.79	EKMH160VSN393MA40S		
	22,000	25.4 × 30	0.60	2.25	EKMH6R3VSN223MQ30S		47,000	35 × 45	0.40	5.43	EKMH160VSN473MA45S		
	22,000	30 × 25	0.60	2.28	EKMH6R3VSN223MR25S		25	4,700	22 × 25	0.30	1.50	EKMH250VSN472MP25S	
	27,000	22 × 40	0.60	2.54	EKMH6R3VSN273MP40S			5,600	22 × 25	0.30	1.63	EKMH250VSN562MP25S	
	27,000	25.4 × 35	0.60	2.57	EKMH6R3VSN273MQ35S			6,800	22 × 30	0.30	1.86	EKMH250VSN682MP30S	
	27,000	30 × 25	0.60	2.52	EKMH6R3VSN273MR25S			6,800	25.4 × 25	0.30	1.87	EKMH250VSN682MQ25S	
	33,000	22 × 45	0.60	2.88	EKMH6R3VSN333MP45S			8,200	22 × 35	0.30	2.11	EKMH250VSN822MP35S	
	33,000	25.4 × 40	0.60	2.93	EKMH6R3VSN333MQ40S			8,200	25.4 × 30	0.30	2.12	EKMH250VSN822MQ30S	
	33,000	30 × 30	0.60	2.89	EKMH6R3VSN333MR30S			8,200	30 × 25	0.30	2.15	EKMH250VSN822MR25S	
	33,000	35 × 25	0.60	2.93	EKMH6R3VSN333MA25S			10,000	22 × 40	0.30	2.39	EKMH250VSN103MP40S	
	39,000	25.4 × 40	0.60	3.18	EKMH6R3VSN393MQ40S	10,000		25.4 × 35	0.30	2.42	EKMH250VSN103MP35S		
	39,000	30 × 35	0.60	3.26	EKMH6R3VSN393MR35S	10,000		30 × 25	0.30	2.37	EKMH250VSN103MR25S		
	39,000	35 × 30	0.60	3.40	EKMH6R3VSN393MA30S	12,000		22 × 45	0.30	2.69	EKMH250VSN123MP45S		
	47,000	25.4 × 50	0.60	3.69	EKMH6R3VSN473MQ50S	12,000		25.4 × 40	0.30	2.74	EKMH250VSN123MQ40S		
	47,000	30 × 40	0.60	3.69	EKMH6R3VSN473MR40S	12,000		30 × 30	0.30	2.70	EKMH250VSN123MR30S		
	47,000	35 × 30	0.60	3.73	EKMH6R3VSN473MA30S	12,000		35 × 25	0.30	2.74	EKMH250VSN123MA25S		
	56,000	30 × 45	0.60	4.16	EKMH6R3VSN563MR45S	15,000		25.4 × 45	0.30	3.15	EKMH250VSN153MQ45S		
	56,000	35 × 35	0.60	4.12	EKMH6R3VSN563MA35S	15,000		30 × 35	0.30	3.13	EKMH250VSN153MR35S		
	68,000	30 × 50	0.60	4.71	EKMH6R3VSN683MR50S	15,000		35 × 30	0.30	3.27	EKMH250VSN153MA30S		
	68,000	35 × 40	0.60	4.69	EKMH6R3VSN683MA40S	18,000		25.4 × 50	0.30	3.54	EKMH250VSN183MQ50S		
82,000	35 × 45	0.60	5.32	EKMH6R3VSN823MA45S	18,000	30 × 40	0.30	3.54	EKMH250VSN183MR40S				
10	10,000	22 × 25	0.50	1.55	EKMH100VSN103MP25S	18,000	35 × 30	0.30	3.58	EKMH250VSN183MA30S			
	12,000	22 × 30	0.50	1.77	EKMH100VSN123MP30S	22,000	30 × 45	0.30	4.04	EKMH250VSN223MR45S			
	15,000	22 × 30	0.50	1.97	EKMH100VSN153MP30S	22,000	35 × 35	0.30	3.64	EKMH250VSN223MA35S			
	15,000	25.4 × 25	0.50	1.96	EKMH100VSN153MQ25S	27,000	35 × 45	0.30	4.73	EKMH250VSN273MA45S			
	18,000	22 × 35	0.50	2.21	EKMH100VSN183MP35S	33,000	35 × 50	0.30	5.39	EKMH250VSN333MA50S			
	18,000	25.4 × 30	0.50	2.23	EKMH100VSN183MQ30S	35	3,300	22 × 25	0.25	1.40	EKMH350VSN332MP25S		
	22,000	22 × 40	0.50	2.51	EKMH100VSN223MP40S		3,900	22 × 30	0.25	1.57	EKMH350VSN392MP30S		
	22,000	25.4 × 35	0.50	2.54	EKMH100VSN223MQ35S		4,700	22 × 30	0.25	1.72	EKMH350VSN472MP30S		
	22,000	30 × 25	0.50	2.40	EKMH100VSN223MR25S		4,700	25.4 × 25	0.25	1.80	EKMH350VSN472MQ25S		
	27,000	22 × 50	0.50	2.93	EKMH100VSN273MP50S		5,600	22 × 35	0.25	1.95	EKMH350VSN562MP35S		
	27,000	25.4 × 40	0.50	2.90	EKMH100VSN273MQ40S		5,600	25.4 × 30	0.25	1.96	EKMH350VSN562MQ30S		
	27,000	30 × 30	0.50	2.87	EKMH100VSN273MR30S		5,600	30 × 25	0.25	1.99	EKMH350VSN562MR25S		
	27,000	35 × 25	0.50	2.73	EKMH100VSN273MA25S		6,800	22 × 40	0.25	2.20	EKMH350VSN682MP40S		
	33,000	25.4 × 45	0.50	3.30	EKMH100VSN333MQ45S		6,800	25.4 × 35	0.25	2.23	EKMH350VSN682MP35S		
	33,000	30 × 35	0.50	3.28	EKMH100VSN333MR35S		6,800	30 × 25	0.25	2.19	EKMH350VSN682MR25S		
	33,000	35 × 30	0.50	3.16	EKMH100VSN333MA30S		8,200	22 × 50	0.25	2.55	EKMH350VSN822MP50S		
	39,000	25.4 × 50	0.50	3.68	EKMH100VSN393MQ50S		8,200	25.4 × 40	0.25	2.53	EKMH350VSN822MQ40S		
	39,000	30 × 40	0.50	3.69	EKMH100VSN393MR40S		8,200	30 × 30	0.25	2.75	EKMH350VSN822MR30S		
	39,000	35 × 30	0.50	3.43	EKMH100VSN393MA30S		8,200	35 × 25	0.25	2.75	EKMH350VSN822MA25S		
	47,000	30 × 45	0.50	4.17	EKMH100VSN473MR45S		10,000	25.4 × 45	0.25	2.87	EKMH350VSN103MQ45S		
	47,000	35 × 35	0.50	3.76	EKMH100VSN473MA35S		10,000	30 × 35	0.25	2.90	EKMH350VSN103MR35S		
	56,000	30 × 50	0.50	4.68	EKMH100VSN563MR50S		10,000	35 × 30	0.25	2.91	EKMH350VSN103MA30S		
	56,000	35 × 40	0.50	4.67	EKMH100VSN563MA40S		12,000	25.4 × 50	0.25	3.24	EKMH350VSN123MQ50S		
	68,000	35 × 50	0.50	5.46	EKMH100VSN683MA50S	12,000	30 × 40	0.25	3.23	EKMH350VSN123MR40S			
16	6,800	22 × 25	0.40	1.57	EKMH160VSN682MP25S	12,000	35 × 30	0.25	2.99	EKMH350VSN123MA30S			
	10,000	22 × 30	0.40	1.97	EKMH160VSN103MP30S	15,000	30 × 45	0.25	3.72	EKMH350VSN153MR45S			
	10,000	25.4 × 25	0.40	1.97	EKMH160VSN103MQ25S	15,000	35 × 35	0.25	3.67	EKMH350VSN153MA35S			
	12,000	22 × 35	0.40	2.22	EKMH160VSN123MP35S	18,000	35 × 40	0.25	4.37	EKMH350VSN183MA40S			
	12,000	25.4 × 30	0.40	2.24	EKMH160VSN123MQ30S	22,000	35 × 50	0.25	4.92	EKMH350VSN223MA50S			
	12,000	30 × 25	0.40	2.45	EKMH160VSN123MR25S	50	1,800	22 × 25	0.20	1.33	EKMH500VSN182MP25S		
	15,000	22 × 40	0.40	2.55	EKMH160VSN153MP40S		2,700	22 × 30	0.20	1.69	EKMH500VSN272MP30S		
	15,000	25.4 × 35	0.40	2.58	EKMH160VSN153MQ35S		2,700	25.4 × 25	0.20	1.70	EKMH500VSN272MQ25S		
	15,000	30 × 25	0.40	2.52	EKMH160VSN153MR25S		3,300	22 × 35	0.20	1.93	EKMH500VSN332MP35S		
	18,000	22 × 45	0.40	2.87	EKMH160VSN183MP45S		3,300	25.4 × 30	0.20	1.85	EKMH500VSN332MQ30S		
	18,000	25.4 × 40	0.40	2.92	EKMH160VSN183MQ40S		3,900	22 × 40	0.20	2.16	EKMH500VSN392MP40S		
	18,000	30 × 30	0.40	2.88	EKMH160VSN183MR30S		3,900	25.4 × 35	0.20	2.18	EKMH500VSN392MQ35S		
	18,000	35 × 25	0.40	2.92	EKMH160VSN183MA25S		3,900	30 × 25	0.20	1.95	EKMH500VSN392MR25S		
	22,000	25.4 × 45	0.40	3.32	EKMH160VSN223MQ45S		4,700	22 × 45	0.20	2.43	EKMH500VSN472MP45S		
	22,000	30 × 35	0.40	3.29	EKMH160VSN223MR35S		4,700	25.4 × 35	0.20	2.39	EKMH500VSN472MQ35S		
	22,000	35 × 25	0.40	3.23	EKMH160VSN223MA25S		4,700	30 × 30	0.20	2.25	EKMH500VSN472MR30S		
	27,000	25.4 × 50	0.40	3.78	EKMH160VSN273MQ50S		4,700	35 × 25	0.20	2.48	EKMH500VSN472MA25S		
	27,000	30 × 40	0.40	3.77	EKMH160VSN273MR40S		5,600	22 × 50	0.20	2.75	EKMH500VSN562MP50S		

Return Group Chart



LARGE CAPACITANCE ALUMINUM ELECTROLYTIC CAPACITORS

Standard snap-ins, 105°C

KMHSeries

◆STANDARD RATINGS

WV (V _{dc})	Cap (μF)	Case size φD×L(mm)	tan δ	Rated ripple current (Arms/105°C, 120Hz)	Part No.	WV (V _{dc})	Cap (μF)	Case size φD×L(mm)	tan δ	Rated ripple current (Arms/105°C, 120Hz)	Part No.
50	5,600	25.4 × 40	0.20	2.70	EKMH500VSN562MQ40S	80	1,800	25.4 × 30	0.15	1.76	EKMH800VSN182MQ30S
	5,600	30 × 35	0.20	2.76	EKMH500VSN562MR35S		1,800	30 × 25	0.15	1.65	EKMH800VSN182MR25S
	5,600	35 × 25	0.20	2.70	EKMH500VSN562MA25S		2,200	22 × 45	0.15	2.04	EKMH800VSN222MP45S
	6,800	25.4 × 50	0.20	3.30	EKMH500VSN682MQ50S		2,200	25.4 × 35	0.15	2.01	EKMH800VSN222MQ35S
	6,800	30 × 40	0.20	3.30	EKMH500VSN682MR40S		2,200	30 × 30	0.15	2.05	EKMH800VSN222MR30S
	6,800	35 × 30	0.20	3.25	EKMH500VSN682MA30S		2,200	35 × 25	0.15	2.07	EKMH800VSN222MA25S
	8,200	30 × 45	0.20	3.60	EKMH500VSN822MR45S		2,700	25.4 × 45	0.15	2.36	EKMH800VSN272MQ45S
	8,200	35 × 35	0.20	3.55	EKMH500VSN822MA35S		2,700	30 × 35	0.15	2.35	EKMH800VSN272MR35S
	10,000	30 × 50	0.20	4.04	EKMH500VSN103MR50S		2,700	35 × 25	0.15	2.29	EKMH800VSN272MA25S
	10,000	35 × 40	0.20	4.03	EKMH500VSN103MA40S		3,300	25.4 × 50	0.15	2.68	EKMH800VSN332MQ50S
12,000	35 × 45	0.20	4.55	EKMH500VSN123MA45S	3,300	30 × 40	0.15	2.68	EKMH800VSN332MP40S		
63	1,200	22 × 25	0.15	1.19	EKMH630VSN122MP25S	3,300	35 × 30	0.15	2.45	EKMH800VSN332MA30S	
	1,500	22 × 25	0.15	1.33	EKMH630VSN152MP25S	3,900	30 × 45	0.15	3.00	EKMH800VSN392MR45S	
	1,800	22 × 30	0.15	1.51	EKMH630VSN182MP30S	3,900	35 × 35	0.15	2.98	EKMH800VSN392MA35S	
	1,800	25.4 × 25	0.15	1.52	EKMH630VSN182MQ25S	4,700	30 × 50	0.15	3.39	EKMH800VSN472MP50S	
	2,200	22 × 35	0.15	1.73	EKMH630VSN222MP35S	4,700	35 × 40	0.15	3.38	EKMH800VSN472MA40S	
	2,200	25.4 × 30	0.15	1.74	EKMH630VSN222MQ30S	5,600	35 × 45	0.15	3.80	EKMH800VSN562MA45S	
	2,700	22 × 40	0.15	1.97	EKMH630VSN272MP40S	6,800	35 × 50	0.15	3.90	EKMH800VSN682MA50S	
	2,700	25.4 × 35	0.15	1.99	EKMH630VSN272MQ35S	100	560	22 × 25	0.15	1.05	EKMH101VSN561MP25S
	2,700	30 × 25	0.15	1.76	EKMH630VSN272MR25S		820	22 × 30	0.15	1.32	EKMH101VSN821MP30S
	3,300	22 × 50	0.15	2.29	EKMH630VSN332MP50S		820	25.4 × 25	0.15	1.33	EKMH101VSN821MQ25S
	3,300	25.4 × 40	0.15	2.27	EKMH630VSN332MQ40S		1,000	22 × 35	0.15	1.50	EKMH101VSN102MP35S
	3,300	30 × 30	0.15	2.24	EKMH630VSN332MR30S		1,000	25.4 × 30	0.15	1.51	EKMH101VSN102MQ30S
	3,300	35 × 25	0.15	2.06	EKMH630VSN332MA25S		1,200	22 × 40	0.15	1.69	EKMH101VSN122MP40S
	3,900	25.4 × 45	0.15	2.54	EKMH630VSN392MQ45S		1,200	25.4 × 35	0.15	1.71	EKMH101VSN122MQ35S
	3,900	30 × 35	0.15	2.55	EKMH630VSN392MR35S		1,200	30 × 25	0.15	1.68	EKMH101VSN122MR25S
	3,900	35 × 25	0.15	2.24	EKMH630VSN392MA25S		1,500	22 × 45	0.15	1.94	EKMH101VSN152MP45S
	4,700	25.4 × 50	0.15	2.86	EKMH630VSN472MQ50S		1,500	25.4 × 40	0.15	1.98	EKMH101VSN152MQ40S
	4,700	30 × 40	0.15	2.86	EKMH630VSN472MR40S		1,500	30 × 30	0.15	1.95	EKMH101VSN152MR30S
	4,700	35 × 30	0.15	2.79	EKMH630VSN472MA30S		1,500	35 × 25	0.15	1.98	EKMH101VSN152MA25S
	5,600	30 × 45	0.15	3.22	EKMH630VSN562MR45S		1,800	25.4 × 45	0.15	2.23	EKMH101VSN182MQ45S
5,600	35 × 35	0.15	3.19	EKMH630VSN562MA35S	1,800		30 × 35	0.15	2.50	EKMH101VSN182MR35S	
6,800	30 × 50	0.15	3.65	EKMH630VSN682MR50S	1,800		35 × 25	0.15	2.17	EKMH101VSN182MA25S	
6,800	35 × 40	0.15	3.64	EKMH630VSN682MA40S	2,200		25.4 × 50	0.15	2.53	EKMH101VSN222MQ50S	
8,200	35 × 45	0.15	3.90	EKMH630VSN822MA45S	2,200		30 × 40	0.15	2.70	EKMH101VSN222MR40S	
10,000	35 × 50	0.15	4.40	EKMH630VSN103MA50S	2,200		35 × 30	0.15	2.50	EKMH101VSN222MA30S	
80	820	22 × 25	0.15	1.11	EKMH800VSN821MP25S		2,700	30 × 45	0.15	2.88	EKMH101VSN272MR45S
	1,000	22 × 25	0.15	1.22	EKMH800VSN102MP25S		2,700	35 × 35	0.15	2.86	EKMH101VSN272MA35S
	1,200	22 × 30	0.15	1.38	EKMH800VSN122MP30S	3,300	30 × 50	0.15	3.28	EKMH101VSN332MR50S	
	1,200	25.4 × 25	0.15	1.39	EKMH800VSN122MQ25S	3,300	35 × 40	0.15	3.27	EKMH101VSN332MA40S	
	1,500	22 × 35	0.15	1.59	EKMH800VSN152MP35S	3,900	35 × 45	0.15	3.67	EKMH101VSN392MA45S	
	1,500	25.4 × 30	0.15	1.61	EKMH800VSN152MQ30S	4,700	35 × 50	0.15	3.80	EKMH101VSN472MA50S	
	1,800	22 × 40	0.15	1.80	EKMH800VSN182MP40S						

*For the rated voltage $\geq 160V_{dc}$, please use KMR and KMQ series.

◆RATED RIPPLE CURRENT MULTIPLIERS

●Frequency Multipliers

Frequency(Hz)	50	120	300	1k	10k	50k
6.3 to 50V _{dc}	0.95	1.00	1.03	1.05	1.08	1.08
63 to 100V _{dc}	0.92	1.00	1.07	1.13	1.19	1.20

The endurance of capacitors is reduced with internal heating produced by ripple current at the rate of halving the lifetime with every 5°C rise. When long life performance is required in actual use, the rms ripple current has to be reduced.

Return Group Chart



LARGE CAPACITANCE ALUMINUM ELECTROLYTIC CAPACITORS

Long life snap-ins, 105°C

TXH Series

- Endurance with ripple current : 10,000 hours at 105°C
- Non solvent resistant type
- RoHS Compliant

TXH

Longer life
LXM P272



SPECIFICATIONS

Items	Characteristics		
Category	-25 to +105°C		
Temperature Range	-25 to +105°C		
Rated Voltage Range	200 to 450V _{dc}		
Capacitance Tolerance	±20% (M) (at 20°C, 120Hz)		
Leakage Current	I ≤ 3√CV Where, I : Max. leakage current (µA), C : Nominal capacitance (µF), V : Rated voltage (V) (at 20°C after 5 minutes)		
Dissipation Factor (tan δ)	Rated voltage (V _{dc})	200 to 400V	450V
	tan δ (Max.)	0.15	0.20
Low Temperature Characteristics (Max. Impedance Ratio)	Rated voltage (V _{dc})	200 to 400V	450V
	Z (-25°C)/Z (+20°C)	4	8
Endurance	The following specifications shall be satisfied when the capacitors are restored to 20°C after subjected to DC voltage with the rated ripple current is applied (the peak voltage shall not exceed the rated voltage) for 10,000 hours at 105°C.		
	Capacitance change	≤ ±20% of the initial value	
	D.F. (tan δ)	≤ 200% of the initial specified value	
	Leakage current	≤ The initial specified value	
Shelf Life	The following specifications shall be satisfied when the capacitors are restored to 20°C after exposing them for 1,000 hours at 105°C without voltage applied. Before the measurement, the capacitor shall be preconditioned by applying voltage according to Item 4.1 of JIS C 5101-4.		
	Capacitance change	≤ ±15% of the initial value	
	D.F. (tan δ)	≤ 150% of the initial specified value	
	Leakage current	≤ The initial specified value	

DIMENSIONS [mm]

Terminal Code : VS (φ30 to φ40) : Standard

Terminal Code : LI (φ35, φ40)

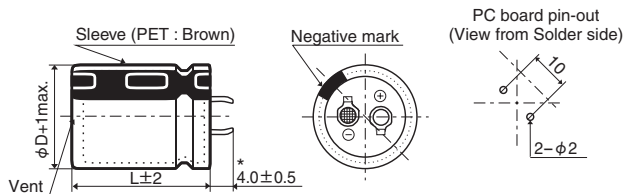

* φD=40mm : 3.5±0.5mm

The standard design has no plastic disc.

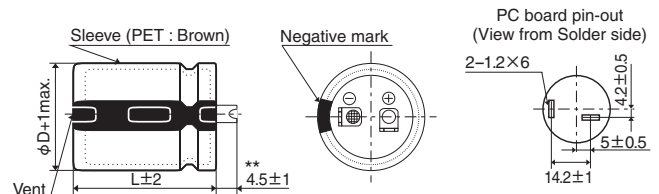

** φD=40mm : 4.0±1

PART NUMBERING SYSTEM

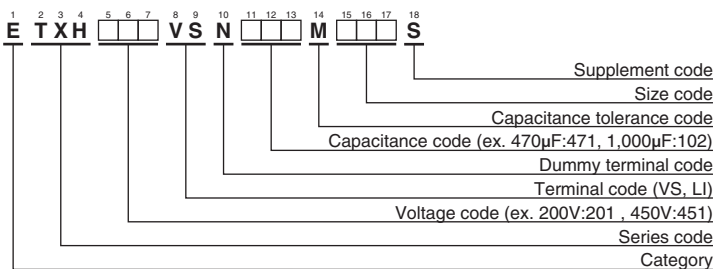

Please refer to "Product code guide (snap-in type)"

Return Group Chart



LARGE CAPACITANCE ALUMINUM ELECTROLYTIC CAPACITORS

Long life snap-ins, 105°C

TXHSeries

◆STANDARD RATINGS

WV (V _{dc})	Cap (μF)	Case size φD×L(mm)	tan δ	Rated ripple current (Arms/105°C, 120Hz)	Part No.	WV (V _{dc})	Cap (μF)	Case size φD×L(mm)	tan δ	Rated ripple current (Arms/105°C, 120Hz)	Part No.
200	560	30 × 30	0.15	1.50	ETXH201VSN561MR30S	400	220	30 × 35	0.15	1.00	ETXH401VSN221MR35S
	680	30 × 35	0.15	1.70	ETXH201VSN681MR35S		270	30 × 40	0.15	1.15	ETXH401VSN271MR40S
	820	30 × 40	0.15	2.00	ETXH201VSN821MR40S		270	35 × 30	0.15	1.13	ETXH401VSN271MA30S
	820	35 × 30	0.15	2.00	ETXH201VSN821MA30S		330	30 × 45	0.15	1.29	ETXH401VSN331MR45S
	1,000	30 × 45	0.15	2.20	ETXH201VSN102MR45S		330	35 × 35	0.15	1.26	ETXH401VSN331MA35S
	1,000	35 × 35	0.15	2.20	ETXH201VSN102MA35S		330	40 × 30	0.15	1.28	ETXH401VSN331MB30S
	1,000	40 × 30	0.15	2.17	ETXH201VSN102MB30S		390	30 × 50	0.15	1.44	ETXH401VSN391MR50S
	1,200	35 × 40	0.15	2.40	ETXH201VSN122MA40S		390	35 × 40	0.15	1.43	ETXH401VSN391MA40S
	1,200	40 × 35	0.15	2.45	ETXH201VSN122MB35S		470	35 × 45	0.15	1.60	ETXH401VSN471MA45S
	1,500	35 × 50	0.15	2.81	ETXH201VSN152MA50S		470	40 × 35	0.15	1.58	ETXH401VSN471MB35S
	1,500	40 × 40	0.15	2.79	ETXH201VSN152MB40S		560	35 × 50	0.15	1.79	ETXH401VSN561MA50S
	1,800	40 × 50	0.15	3.24	ETXH201VSN182MB50S		560	40 × 40	0.15	1.78	ETXH401VSN561MB40S
250	390	30 × 30	0.15	1.30	ETXH251VSN391MR30S	680	40 × 50	0.15	2.05	ETXH401VSN681MB50S	
	470	30 × 35	0.15	1.42	ETXH251VSN471MR35S	820	40 × 60	0.15	2.36	ETXH401VSN821MB60S	
	560	35 × 30	0.15	1.58	ETXH251VSN561MA30S	450	220	30 × 40	0.20	1.04	ETXH451VSN221MR40S
	680	30 × 45	0.15	1.80	ETXH251VSN681MR45S		220	35 × 30	0.20	1.02	ETXH451VSN221MA30S
	680	35 × 35	0.15	1.76	ETXH251VSN681MA35S		270	30 × 45	0.20	1.19	ETXH451VSN271MR45S
	820	30 × 50	0.15	2.03	ETXH251VSN821MR50S		270	35 × 35	0.20	1.16	ETXH451VSN271MA35S
	820	35 × 40	0.15	2.01	ETXH251VSN821MA40S		330	30 × 50	0.20	1.33	ETXH451VSN331MR50S
	820	40 × 30	0.15	1.96	ETXH251VSN821MB30S		330	35 × 40	0.20	1.32	ETXH451VSN331MA40S
	1,000	35 × 45	0.15	2.30	ETXH251VSN102MA45S		390	35 × 45	0.20	1.48	ETXH451VSN391MA45S
	1,000	40 × 35	0.15	2.27	ETXH251VSN102MB35S		470	35 × 50	0.20	1.64	ETXH451VSN471MA50S
	1,200	35 × 50	0.15	2.55	ETXH251VSN122MA50S		560	40 × 60	0.20	1.98	ETXH451VSN561MB60S
	1,200	40 × 40	0.15	2.53	ETXH251VSN122MB40S						
1,500	40 × 50	0.15	2.96	ETXH251VSN152MB50S							
1,800	40 × 60	0.15	3.39	ETXH251VSN182MB60S							

◆RATED RIPPLE CURRENT MULTIPLIERS

● Frequency Multipliers

Frequency(Hz)	50	120	300	1k	10k	50k
200, 250V _{dc}	0.81	1.00	1.17	1.32	1.45	1.50
400, 450V _{dc}	0.77	1.00	1.16	1.30	1.41	1.43

The endurance of capacitors is reduced with internal heating produced by ripple current at the rate of halving the lifetime with every 5°C rise. When long life performance is required in actual use, the rms ripple current has to be reduced.

Return Group Chart



LARGE CAPACITANCE ALUMINUM ELECTROLYTIC CAPACITORS

Long life snap-ins, 105°C

LXM Series

- Endurance with ripple current : 7,000 hours at 105°C
- Non solvent resistant type
- RoHS Compliant

LXM

Longer life

LXQ P278



SPECIFICATIONS

Items	Characteristics		
Category	-25 to +105°C		
Temperature Range	-25 to +105°C		
Rated Voltage Range	160 to 450V _{dc}		
Capacitance Tolerance	±20% (M)		(at 20°C, 120Hz)
Leakage Current	I ≤ 3√CV Where, I : Max. leakage current (μA), C : Nominal capacitance (μF), V : Rated voltage (V) (at 20°C after 5 minutes)		
Dissipation Factor (tan δ)	Rated voltage (V _{dc})	160 to 400V	420 & 450V
	tan δ (Max.)	0.15	0.20
Low Temperature Characteristics (Max. Impedance Ratio)	Rated voltage (V _{dc})	160 to 400V	420 & 450V
	Z (-25°C)/Z (+20°C)	4	8
Endurance	The following specifications shall be satisfied when the capacitors are restored to 20°C after subjected to DC voltage with the rated ripple current is applied (the peak voltage shall not exceed the rated voltage) for 7,000 hours at 105°C.		
	Capacitance change	≤ ±20% of the initial value	
	D.F. (tan δ)	≤ 250% of the initial specified value	
	Leakage current	≤ The initial specified value	
Shelf Life	The following specifications shall be satisfied when the capacitors are restored to 20°C after exposing them for 1,000 hours at 105°C without voltage applied. Before the measurement, the capacitor shall be preconditioned by applying voltage according to Item 4.1 of JIS C 5101-4.		
	Capacitance change	≤ ±15% of the initial value	
	D.F. (tan δ)	≤ 150% of the initial specified value	
	Leakage current	≤ The initial specified value	

DIMENSIONS [mm]

Terminal Code : VS (φ22 to φ35) : Standard

Terminal Code : LI (φ35)

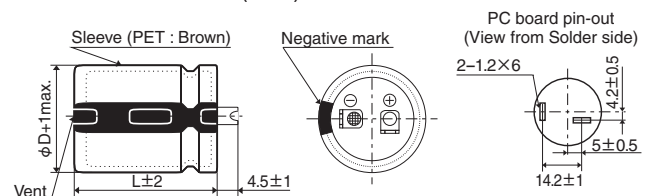
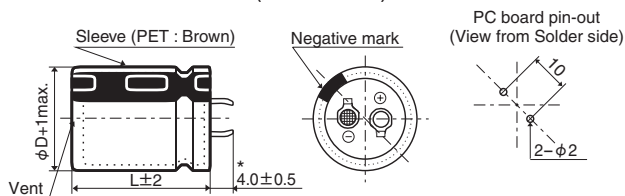

* φD=35mm : 3.5±0.5mm

The standard design has no plastic disc.

PART NUMBERING SYSTEM

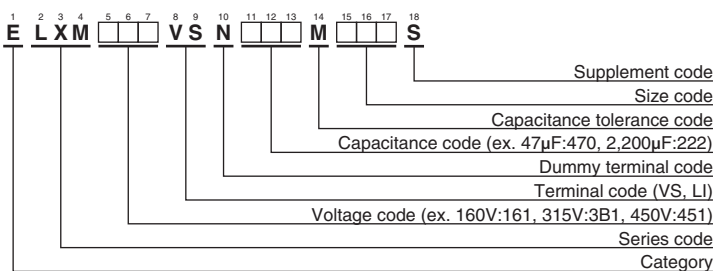

Please refer to "Product code guide (snap-in type)"

◆ STANDARD RATINGS

WV (V _{dc})	Cap (μF)	Case size φD×L(mm)	tan δ	Rated ripple current (Arms/ 105°C, 120Hz)	Part No.	WV (V _{dc})	Cap (μF)	Case size φD×L(mm)	tan δ	Rated ripple current (Arms/ 105°C, 120Hz)	Part No.
160	330	22 × 25	0.15	1.11	ELXM161VSN331MP25S	220	220	22 × 25	0.15	0.90	ELXM221VSN221MP25S
	390	22 × 30	0.15	1.26	ELXM161VSN391MP30S		270	22 × 30	0.15	1.05	ELXM221VSN271MP30S
	470	22 × 30	0.15	1.39	ELXM161VSN471MP30S		330	22 × 35	0.15	1.19	ELXM221VSN331MP35S
	470	25.4 × 25	0.15	1.38	ELXM161VSN471MQ25S		330	25.4 × 25	0.15	1.16	ELXM221VSN331MQ25S
	560	22 × 35	0.15	1.55	ELXM161VSN561MP35S		390	22 × 40	0.15	1.33	ELXM221VSN391MP40S
	560	25.4 × 30	0.15	1.55	ELXM161VSN561MQ30S		390	25.4 × 30	0.15	1.29	ELXM221VSN391MQ30S
	680	22 × 40	0.15	1.75	ELXM161VSN681MP40S		470	22 × 45	0.15	1.49	ELXM221VSN471MP45S
	680	25.4 × 35	0.15	1.78	ELXM161VSN681MQ35S		470	25.4 × 35	0.15	1.48	ELXM221VSN471MQ35S
	680	30 × 25	0.15	1.74	ELXM161VSN681MR25S		470	30 × 25	0.15	1.45	ELXM221VSN471MR25S
	820	22 × 50	0.15	1.97	ELXM161VSN821MP50S		560	22 × 50	0.15	1.63	ELXM221VSN561MP50S
	820	25.4 × 40	0.15	2.01	ELXM161VSN821MQ40S		560	25.4 × 40	0.15	1.71	ELXM221VSN561MQ40S
	820	30 × 30	0.15	1.96	ELXM161VSN821MR30S		560	30 × 30	0.15	1.62	ELXM221VSN561MR30S
	1,000	25.4 × 45	0.15	2.27	ELXM161VSN102MQ45S		680	25.4 × 45	0.15	1.87	ELXM221VSN681MQ45S
	1,000	30 × 35	0.15	2.26	ELXM161VSN102MR35S		680	30 × 35	0.15	1.86	ELXM221VSN681MR35S
	1,200	25.4 × 50	0.15	2.54	ELXM161VSN122MQ50S		820	25.4 × 50	0.15	2.10	ELXM221VSN821MQ50S
	1,200	30 × 40	0.15	2.56	ELXM161VSN122MR40S		820	30 × 40	0.15	2.12	ELXM221VSN821MR40S
	1,200	35 × 30	0.15	2.52	ELXM161VSN122MA30S		820	35 × 30	0.15	2.08	ELXM221VSN821MA30S
	1,500	30 × 45	0.15	2.96	ELXM161VSN152MR45S		1,000	30 × 50	0.15	2.48	ELXM221VSN102MR50S
	1,500	35 × 35	0.15	2.89	ELXM161VSN152MA35S		1,000	35 × 40	0.15	2.46	ELXM221VSN102MA40S
	1,800	30 × 50	0.15	3.32	ELXM161VSN182MR50S		1,200	35 × 45	0.15	2.78	ELXM221VSN122MA45S
	1,800	35 × 40	0.15	3.30	ELXM161VSN182MA40S		1,500	35 × 50	0.15	3.20	ELXM221VSN152MA50S
	2,200	35 × 50	0.15	3.87	ELXM161VSN222MA50S						
180	270	22 × 25	0.15	1.00	ELXM181VSN271MP25S	250	180	22 × 25	0.15	0.82	ELXM251VSN181MP25S
	330	22 × 30	0.15	1.16	ELXM181VSN331MP30S		220	22 × 30	0.15	0.95	ELXM251VSN221MP30S
	390	22 × 30	0.15	1.26	ELXM181VSN391MP30S		270	22 × 35	0.15	1.08	ELXM251VSN271MP35S
	390	25.4 × 25	0.15	1.26	ELXM181VSN391MQ25S		270	25.4 × 25	0.15	1.05	ELXM251VSN271MQ25S
	470	22 × 35	0.15	1.42	ELXM181VSN471MP35S		330	22 × 40	0.15	1.22	ELXM251VSN331MP40S
	470	25.4 × 30	0.15	1.42	ELXM181VSN471MQ30S		330	25.4 × 30	0.15	1.19	ELXM251VSN331MQ30S
	560	22 × 40	0.15	1.59	ELXM181VSN561MP40S		390	22 × 45	0.15	1.36	ELXM251VSN391MP45S
	560	25.4 × 30	0.15	1.55	ELXM181VSN561MQ30S		390	25.4 × 35	0.15	1.35	ELXM251VSN391MQ35S
	560	30 × 25	0.15	1.58	ELXM181VSN561MR25S		390	30 × 25	0.15	1.32	ELXM251VSN391MR25S
	680	22 × 45	0.15	1.79	ELXM181VSN681MP45S		470	22 × 50	0.15	1.49	ELXM251VSN471MP50S
	680	25.4 × 35	0.15	1.78	ELXM181VSN681MQ35S		470	25.4 × 40	0.15	1.52	ELXM251VSN471MQ40S
	680	30 × 30	0.15	1.79	ELXM181VSN681MR30S		470	30 × 30	0.15	1.49	ELXM251VSN471MR30S
	820	25.4 × 40	0.15	2.01	ELXM181VSN821MQ40S		560	25.4 × 45	0.15	1.70	ELXM251VSN561MQ45S
	820	30 × 35	0.15	2.04	ELXM181VSN821MR35S		560	30 × 35	0.15	1.69	ELXM251VSN561MR35S
	1,000	25.4 × 50	0.15	2.32	ELXM181VSN102MQ50S		680	25.4 × 50	0.15	1.91	ELXM251VSN681MQ50S
	1,000	30 × 35	0.15	2.26	ELXM181VSN102MR35S		680	30 × 40	0.15	1.93	ELXM251VSN681MR40S
	1,000	35 × 30	0.15	2.30	ELXM181VSN102MA30S		680	35 × 30	0.15	1.90	ELXM251VSN681MA30S
	1,200	30 × 45	0.15	2.65	ELXM181VSN122MR45S		820	30 × 45	0.15	2.19	ELXM251VSN821MR45S
	1,200	35 × 35	0.15	2.58	ELXM181VSN122MA35S		820	35 × 35	0.15	2.13	ELXM251VSN821MA35S
	1,500	30 × 50	0.15	3.03	ELXM181VSN152MR50S		1,000	35 × 40	0.15	2.46	ELXM251VSN102MA40S
	1,500	35 × 40	0.15	3.01	ELXM181VSN152MA40S		1,200	35 × 50	0.15	2.86	ELXM251VSN122MA50S
	1,800	35 × 45	0.15	3.41	ELXM181VSN182MA45S						
2,200	35 × 50	0.15	3.87	ELXM181VSN222MA50S							
200	220	22 × 25	0.15	0.90	ELXM201VSN221MP25S	315	100	22 × 25	0.15	0.67	ELXM3B1VSN101MP25S
	270	22 × 30	0.15	1.05	ELXM201VSN271MP30S		120	22 × 30	0.15	0.77	ELXM3B1VSN121MP30S
	330	22 × 30	0.15	1.16	ELXM201VSN331MP30S		150	22 × 30	0.15	0.86	ELXM3B1VSN151MP30S
	330	25.4 × 25	0.15	1.16	ELXM201VSN331MQ25S		150	25.4 × 25	0.15	0.85	ELXM3B1VSN151MQ25S
	390	22 × 35	0.15	1.29	ELXM201VSN391MP35S		180	22 × 35	0.15	0.96	ELXM3B1VSN181MP35S
	390	25.4 × 30	0.15	1.29	ELXM201VSN391MQ30S		180	25.4 × 30	0.15	0.96	ELXM3B1VSN181MQ30S
	470	22 × 40	0.15	1.46	ELXM201VSN471MP40S		220	22 × 40	0.15	1.09	ELXM3B1VSN221MP40S
	470	25.4 × 30	0.15	1.42	ELXM201VSN471MQ30S		220	25.4 × 30	0.15	1.06	ELXM3B1VSN221MQ30S
	470	30 × 25	0.15	1.45	ELXM201VSN471MR25S		220	30 × 25	0.15	1.08	ELXM3B1VSN221MR25S
	560	22 × 45	0.15	1.63	ELXM201VSN561MP45S		270	22 × 45	0.15	1.24	ELXM3B1VSN271MP45S
	560	25.4 × 35	0.15	1.62	ELXM201VSN561MQ35S		270	25.4 × 35	0.15	1.23	ELXM3B1VSN271MQ35S
	560	30 × 30	0.15	1.62	ELXM201VSN561MR30S		270	30 × 30	0.15	1.23	ELXM3B1VSN271MR30S
	680	25.4 × 40	0.15	1.83	ELXM201VSN681MQ40S		330	25.4 × 40	0.15	1.40	ELXM3B1VSN331MQ40S
	680	30 × 30	0.15	1.79	ELXM201VSN681MR30S		330	30 × 35	0.15	1.42	ELXM3B1VSN331MR35S
	820	25.4 × 45	0.15	2.06	ELXM201VSN821MQ45S		330	35 × 30	0.15	1.45	ELXM3B1VSN331MA30S
	820	30 × 35	0.15	2.04	ELXM201VSN821MR35S		390	25.4 × 50	0.15	1.59	ELXM3B1VSN391MQ50S
	1,000	30 × 45	0.15	2.42	ELXM201VSN102MR45S		390	30 × 35	0.15	1.54	ELXM3B1VSN391MR35S
	1,000	35 × 30	0.15	2.30	ELXM201VSN102MA30S		390	35 × 30	0.15	1.57	ELXM3B1VSN391MA30S
	1,200	30 × 50	0.15	2.71	ELXM201VSN122MR50S		470	30 × 45	0.15	1.81	ELXM3B1VSN471MR45S
	1,200	35 × 40	0.15	2.70	ELXM201VSN122MA40S		470	35 × 35	0.15	1.77	ELXM3B1VSN471MA35S
	1,500	35 × 45	0.15	3.11	ELXM201VSN152MA45S		560	30 × 50	0.15	2.03	ELXM3B1VSN561MR50S
	1,800	35 × 50	0.15	3.50	ELXM201VSN182MA50S		560	35 × 40	0.15	2.02	ELXM3B1VSN561MA40S
					680	35 × 45	0.15	2.29	ELXM3B1VSN681MA45S		
					820	35 × 50	0.15	2.59	ELXM3B1VSN821MA50S		

Return Group Chart



LARGE CAPACITANCE ALUMINUM ELECTROLYTIC CAPACITORS

Long life snap-ins, 105°C

LXM Series

◆STANDARD RATINGS

WV (V _{dc})	Cap (μF)	Case size φD×L(mm)	tan δ	Rated ripple current (Arms/105°C, 120Hz)	Part No.	WV (V _{dc})	Cap (μF)	Case size φD×L(mm)	tan δ	Rated ripple current (Arms/105°C, 120Hz)	Part No.
350	100	22 × 25	0.15	0.67	ELXM351VSN101MP25S	420	56	22 × 25	0.20	0.50	ELXM421VSN560MP25S
	120	22 × 30	0.15	0.77	ELXM351VSN121MP30S		68	22 × 30	0.20	0.58	ELXM421VSN680MP30S
	120	25.4 × 25	0.15	0.76	ELXM351VSN121MQ25S		82	22 × 30	0.20	0.63	ELXM421VSN820MP30S
	150	22 × 35	0.15	0.88	ELXM351VSN151MP35S		82	25.4 × 25	0.20	0.63	ELXM421VSN820MQ25S
	150	25.4 × 30	0.15	0.88	ELXM351VSN151MQ30S		100	22 × 35	0.20	0.72	ELXM421VSN101MP35S
	180	22 × 40	0.15	0.99	ELXM351VSN181MP40S		100	25.4 × 30	0.20	0.72	ELXM421VSN101MQ30S
	180	25.4 × 30	0.15	0.96	ELXM351VSN181MQ30S		120	22 × 40	0.20	0.81	ELXM421VSN121MP40S
	180	30 × 25	0.15	0.98	ELXM351VSN181MR25S		120	25.4 × 30	0.20	0.79	ELXM421VSN121MQ30S
	220	22 × 45	0.15	1.12	ELXM351VSN221MP45S		120	30 × 25	0.20	0.80	ELXM421VSN121MR25S
	220	25.4 × 35	0.15	1.11	ELXM351VSN221MQ35S		150	22 × 45	0.20	0.92	ELXM421VSN151MP45S
	220	30 × 30	0.15	1.11	ELXM351VSN221MR30S		150	25.4 × 35	0.20	0.92	ELXM421VSN151MQ35S
	270	25.4 × 40	0.15	1.26	ELXM351VSN271MQ40S		150	30 × 30	0.20	0.92	ELXM421VSN151MR30S
	270	30 × 35	0.15	1.28	ELXM351VSN271MR35S		180	25.4 × 40	0.20	1.03	ELXM421VSN181MQ40S
	330	25.4 × 45	0.15	1.40	ELXM351VSN331MQ45S		180	30 × 35	0.20	1.05	ELXM421VSN181MR35S
	330	30 × 35	0.15	1.42	ELXM351VSN331MR35S		220	25.4 × 50	0.20	1.19	ELXM421VSN221MQ50S
	330	35 × 30	0.15	1.45	ELXM351VSN331MA30S		220	30 × 35	0.20	1.16	ELXM421VSN221MR35S
	390	30 × 40	0.15	1.60	ELXM351VSN391MR40S		220	35 × 30	0.20	1.18	ELXM421VSN221MA30S
	390	35 × 35	0.15	1.61	ELXM351VSN391MA35S		270	30 × 45	0.20	1.38	ELXM421VSN271MR45S
	470	30 × 50	0.15	1.86	ELXM351VSN471MR50S		270	35 × 35	0.20	1.34	ELXM421VSN271MA35S
	470	35 × 40	0.15	1.85	ELXM351VSN471MA40S		330	30 × 50	0.20	1.56	ELXM421VSN331MR50S
560	35 × 40	0.15	2.02	ELXM351VSN561MA40S	330	35 × 40	0.20	1.55	ELXM421VSN331MA40S		
680	35 × 50	0.15	2.36	ELXM351VSN681MA50S	390	35 × 45	0.20	1.74	ELXM421VSN391MA45S		
400	68	22 × 25	0.15	0.55	ELXM401VSN680MP25S	470	35 × 50	0.20	1.96	ELXM421VSN471MA50S	
	82	22 × 30	0.15	0.63	ELXM401VSN820MP30S	450	47	22 × 25	0.20	0.46	ELXM451VSN470MP25S
	100	22 × 30	0.15	0.70	ELXM401VSN101MP30S		56	22 × 30	0.20	0.52	ELXM451VSN560MP30S
	100	25.4 × 25	0.15	0.70	ELXM401VSN101MQ25S		68	22 × 30	0.20	0.58	ELXM451VSN680MP30S
	120	22 × 35	0.15	0.79	ELXM401VSN121MP35S		68	25.4 × 25	0.20	0.58	ELXM451VSN680MQ25S
	120	25.4 × 30	0.15	0.79	ELXM401VSN121MQ30S		82	22 × 35	0.20	0.65	ELXM451VSN820MP35S
	150	22 × 40	0.15	0.90	ELXM401VSN151MP40S		82	25.4 × 30	0.20	0.65	ELXM451VSN820MQ30S
	150	25.4 × 30	0.15	0.88	ELXM401VSN151MQ30S		100	22 × 40	0.20	0.74	ELXM451VSN101MP40S
	150	30 × 25	0.15	0.90	ELXM401VSN151MR25S		100	25.4 × 30	0.20	0.72	ELXM451VSN101MQ30S
	180	22 × 45	0.15	0.99	ELXM401VSN181MP45S		100	30 × 25	0.20	0.73	ELXM451VSN101MR25S
	180	25.4 × 35	0.15	1.01	ELXM401VSN181MQ35S		120	22 × 45	0.20	0.83	ELXM451VSN121MP45S
	180	30 × 30	0.15	1.01	ELXM401VSN181MR30S		120	25.4 × 35	0.20	0.82	ELXM451VSN121MQ35S
	220	25.4 × 40	0.15	1.14	ELXM401VSN221MQ40S		120	30 × 30	0.20	0.82	ELXM451VSN121MR30S
	220	30 × 35	0.15	1.16	ELXM401VSN221MR35S		150	25.4 × 40	0.20	0.94	ELXM451VSN151MQ40S
	270	25.4 × 50	0.15	1.32	ELXM401VSN271MQ50S		150	30 × 35	0.20	0.96	ELXM451VSN151MR35S
	270	30 × 40	0.15	1.33	ELXM401VSN271MR40S		180	25.4 × 45	0.20	1.06	ELXM451VSN181MQ45S
	270	35 × 30	0.15	1.31	ELXM401VSN271MA30S		180	30 × 35	0.20	1.05	ELXM451VSN181MR35S
	330	30 × 45	0.15	1.52	ELXM401VSN331MR45S		180	35 × 30	0.20	1.07	ELXM451VSN181MA30S
	330	35 × 35	0.15	1.48	ELXM401VSN331MA35S		220	30 × 40	0.20	1.20	ELXM451VSN221MR40S
	390	30 × 50	0.15	1.69	ELXM401VSN391MR50S		220	35 × 35	0.20	1.21	ELXM451VSN221MA35S
390	35 × 40	0.15	1.68	ELXM401VSN391MA40S	270		30 × 50	0.20	1.41	ELXM451VSN271MR50S	
470	35 × 45	0.15	1.91	ELXM401VSN471MA45S	270	35 × 40	0.20	1.40	ELXM451VSN271MA40S		
560	35 × 50	0.15	2.14	ELXM401VSN561MA50S	330	35 × 45	0.20	1.60	ELXM451VSN331MA45S		
					390	35 × 50	0.20	1.79	ELXM451VSN391MA50S		

◆RATED RIPPLE CURRENT MULTIPLIERS

● Frequency Multipliers

Frequency(Hz)	50	120	300	1k	10k	50k
160 to 250V _{dc}	0.81	1.00	1.17	1.32	1.45	1.50
315 to 450V _{dc}	0.77	1.00	1.16	1.30	1.41	1.43

The endurance of capacitors is reduced with internal heating produced by ripple current at the rate of halving the lifetime with every 5°C rise. When long life performance is required in actual use, the rms ripple current has to be reduced.

Return Group Chart



LARGE CAPACITANCE ALUMINUM ELECTROLYTIC CAPACITORS

Long life snap-ins, 105°C

LXS Series Upgrade!

- For solar power generation
- Added 550V
- Endurance with ripple current : 5,000 hours at 105°C
- Rated voltage range : 160 to 550V
- Downsized from LXQ series
- Non solvent resistant type
- RoHS Compliant

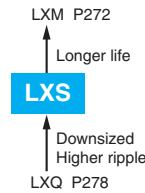

550V Lineup!



◆ SPECIFICATIONS

Items	Characteristics		
Category	-25 to +105°C		
Temperature Range	-25 to +105°C		
Rated Voltage Range	160 to 550V _{dc}		
Capacitance Tolerance	±20% (M) (at 20°C, 120Hz)		
Leakage Current	$I \leq 3\sqrt{CV}$ Where, I : Max. leakage current (µA), C : Nominal capacitance (µF), V : Rated voltage (V) (at 20°C after 5 minutes)		
Dissipation Factor (tan δ)	Rated voltage (V _{dc})	160 to 400V	420 to 550V
	tan δ (Max.)	0.15	0.20
Low Temperature Characteristics (Max. Impedance Ratio)	Rated voltage (V _{dc})	160 to 400V	420 to 550V
	Z(-25°C)/Z(+20°C)	4	8
Endurance	The following specifications shall be satisfied when the capacitors are restored to 20°C after subjected to DC voltage with the rated ripple current is applied (the peak voltage shall not exceed the rated voltage) for 5,000 hours at 105°C.		
	Capacitance change	≤ ±20% of the initial value	
	D.F. (tan δ)	≤200% of the initial specified value (500V _{dc} : ≤ 250%, 550V _{dc} : ≤ 300%)	
	Leakage current	≤ The initial specified value	
Shelf Life	The following specifications shall be satisfied when the capacitors are restored to 20°C after exposing them for 1,000 hours at 105°C without voltage applied. Before the measurement, the capacitor shall be preconditioned by applying voltage according to Item 4.1 of JIS C 5101-4.		
	Capacitance change	≤ ±15% of the initial value	
	D.F. (tan δ)	≤150% of the initial specified value	
	Leakage current	≤ The initial specified value	

◆ DIMENSIONS [mm]

● Terminal Code : VS (φ22 to φ35) : Standard

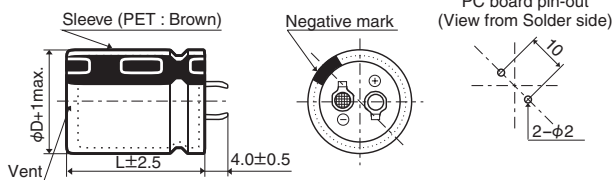

● Terminal Code : LI (φ30, φ35)

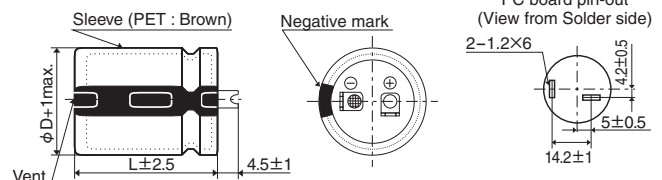

The standard design has no plastic disc.

◆ PART NUMBERING SYSTEM

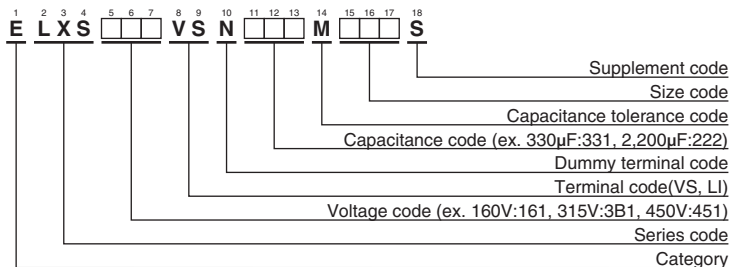

Please refer to "Product code guide (snap-in type)"

Return Group Chart



LARGE CAPACITANCE ALUMINUM ELECTROLYTIC CAPACITORS

Long life snap-ins, 105°C

LXS Upgrade! Series

◆ STANDARD RATINGS

WV (V _{dc})	Cap (μF)	Case size φD×L(mm)	tan δ	Rated ripple current (Arms/105°C, 120Hz)	Part No.	WV (V _{dc})	Cap (μF)	Case size φD×L(mm)	tan δ	Rated ripple current (Arms/105°C, 120Hz)	Part No.
160	470	22 × 25	0.15	1.47	ELXS161VSN471MP25S	200	1,500	35 × 35	0.15	3.36	ELXS201VSN152MA35S
	680	22 × 30	0.15	1.86	ELXS161VSN681MP30S		1,800	30 × 50	0.15	3.72	ELXS201VSN182MR50S
	680	25.4 × 25	0.15	1.84	ELXS161VSN681MQ25S		1,800	35 × 40	0.15	3.81	ELXS201VSN182MA40S
	820	22 × 35	0.15	2.09	ELXS161VSN821MP35S		2,200	35 × 45	0.15	4.32	ELXS201VSN222MA45S
	820	25.4 × 30	0.15	2.08	ELXS161VSN821MQ30S		2,700	35 × 50	0.15	4.88	ELXS201VSN272MA50S
	1,000	22 × 40	0.15	2.35	ELXS161VSN102MP40S		270	22 × 25	0.15	1.11	ELXS251VSN271MP25S
	1,000	22 × 45	0.15	2.40	ELXS161VSN102MP45S		330	22 × 30	0.15	1.29	ELXS251VSN331MP30S
	1,000	25.4 × 35	0.15	2.40	ELXS161VSN102MQ35S		390	22 × 35	0.15	1.44	ELXS251VSN391MP35S
	1,000	30 × 25	0.15	2.50	ELXS161VSN102MR25S		390	25.4 × 25	0.15	1.40	ELXS251VSN391MQ25S
	1,200	22 × 50	0.15	2.69	ELXS161VSN122MP50S		470	22 × 40	0.15	1.61	ELXS251VSN471MP40S
	1,200	25.4 × 40	0.15	2.68	ELXS161VSN122MQ40S		470	25.4 × 30	0.15	1.57	ELXS251VSN471MQ30S
	1,200	30 × 30	0.15	2.77	ELXS161VSN122MR30S		560	22 × 45	0.15	1.79	ELXS251VSN561MP45S
	1,200	35 × 25	0.15	2.91	ELXS161VSN122MA25S		560	25.4 × 35	0.15	1.79	ELXS251VSN561MQ35S
	1,500	25.4 × 45	0.15	3.05	ELXS161VSN152MQ45S		560	30 × 25	0.15	1.87	ELXS251VSN561MR25S
	1,500	30 × 35	0.15	3.17	ELXS161VSN152MR35S		680	22 × 50	0.15	2.02	ELXS251VSN681MP50S
	1,800	25.4 × 50	0.15	3.40	ELXS161VSN182MQ50S		680	25.4 × 40	0.15	2.02	ELXS251VSN681MQ40S
	1,800	30 × 40	0.15	3.57	ELXS161VSN182MR40S		680	30 × 30	0.15	2.08	ELXS251VSN681MR30S
	1,800	35 × 30	0.15	3.62	ELXS161VSN182MA30S		680	35 × 25	0.15	2.19	ELXS251VSN681MA25S
	2,200	30 × 45	0.15	4.05	ELXS161VSN222MR45S		820	25.4 × 45	0.15	2.26	ELXS251VSN821MQ45S
	2,200	30 × 50	0.15	4.11	ELXS161VSN222MR50S		820	25.4 × 50	0.15	2.29	ELXS251VSN821MQ50S
	2,200	35 × 35	0.15	4.07	ELXS161VSN222MA35S		820	30 × 35	0.15	2.34	ELXS251VSN821MR35S
	2,700	35 × 40	0.15	4.67	ELXS161VSN272MA40S		820	35 × 30	0.15	2.45	ELXS251VSN821MA30S
	2,700	35 × 45	0.15	4.78	ELXS161VSN272MA45S		1,000	30 × 40	0.15	2.66	ELXS251VSN102MR40S
3,300	35 × 50	0.15	5.40	ELXS161VSN332MA50S	1,200	30 × 45	0.15	2.99	ELXS251VSN122MR45S		
180	390	22 × 25	0.15	1.34	ELXS181VSN391MP25S	1,200	30 × 50	0.15	3.04	ELXS251VSN122MR50S	
	560	22 × 30	0.15	1.68	ELXS181VSN561MP30S	1,200	35 × 35	0.15	3.00	ELXS251VSN122MA35S	
	560	25.4 × 25	0.15	1.67	ELXS181VSN561MQ25S	1,200	35 × 40	0.15	3.11	ELXS251VSN122MA40S	
	680	22 × 35	0.15	1.90	ELXS181VSN681MP35S	1,500	35 × 45	0.15	3.56	ELXS251VSN152MA45S	
	820	22 × 40	0.15	2.13	ELXS181VSN821MP40S	1,800	35 × 50	0.15	3.98	ELXS251VSN182MA50S	
	820	25.4 × 30	0.15	2.08	ELXS181VSN821MQ30S	180	22 × 25	0.15	0.95	ELXS3B1VSN181MP25S	
	820	25.4 × 35	0.15	2.17	ELXS181VSN821MQ35S	220	22 × 30	0.15	1.10	ELXS3B1VSN221MP30S	
	820	30 × 25	0.15	2.26	ELXS181VSN821MR25S	220	25.4 × 25	0.15	1.10	ELXS3B1VSN221MQ25S	
	1,000	22 × 45	0.15	2.40	ELXS181VSN102MP45S	270	22 × 35	0.15	1.24	ELXS3B1VSN271MP35S	
	1,000	22 × 50	0.15	2.45	ELXS181VSN102MP50S	270	25.4 × 30	0.15	1.25	ELXS3B1VSN271MQ30S	
	1,000	25.4 × 40	0.15	2.45	ELXS181VSN102MQ40S	330	22 × 40	0.15	1.40	ELXS3B1VSN331MP40S	
	1,000	30 × 30	0.15	2.52	ELXS181VSN102MR30S	330	30 × 25	0.15	1.43	ELXS3B1VSN331MR25S	
	1,000	35 × 25	0.15	2.66	ELXS181VSN102MA25S	390	22 × 45	0.15	1.56	ELXS3B1VSN391MP45S	
	1,200	25.4 × 45	0.15	2.73	ELXS181VSN122MQ45S	390	22 × 50	0.15	1.59	ELXS3B1VSN391MP50S	
	1,200	30 × 35	0.15	2.83	ELXS181VSN122MR35S	390	25.4 × 35	0.15	1.57	ELXS3B1VSN391MQ35S	
	1,500	25.4 × 50	0.15	3.10	ELXS181VSN152MQ50S	470	25.4 × 40	0.15	1.76	ELXS3B1VSN471MQ40S	
	1,500	30 × 40	0.15	3.26	ELXS181VSN152MR40S	470	25.4 × 45	0.15	1.79	ELXS3B1VSN471MQ45S	
	1,500	35 × 30	0.15	3.31	ELXS181VSN152MA30S	470	30 × 30	0.15	1.73	ELXS3B1VSN471MR30S	
	1,800	30 × 45	0.15	3.66	ELXS181VSN182MR45S	470	35 × 25	0.15	1.82	ELXS3B1VSN471MA25S	
	1,800	35 × 35	0.15	3.68	ELXS181VSN182MA35S	560	25.4 × 50	0.15	1.99	ELXS3B1VSN561MQ50S	
	2,200	30 × 50	0.15	4.11	ELXS181VSN222MR50S	560	30 × 35	0.15	1.93	ELXS3B1VSN561MR35S	
	2,200	35 × 40	0.15	4.22	ELXS181VSN222MA40S	560	35 × 30	0.15	2.02	ELXS3B1VSN561MA30S	
	2,200	35 × 45	0.15	4.32	ELXS181VSN222MA45S	680	30 × 40	0.15	2.19	ELXS3B1VSN681MR40S	
2,700	35 × 50	0.15	4.88	ELXS181VSN272MA50S	680	30 × 45	0.15	2.25	ELXS3B1VSN681MR45S		
200	390	22 × 25	0.15	1.34	ELXS201VSN391MP25S	680	35 × 35	0.15	2.26	ELXS3B1VSN681MA35S	
	470	22 × 30	0.15	1.54	ELXS201VSN471MP30S	820	30 × 50	0.15	2.51	ELXS3B1VSN821MR50S	
	560	22 × 35	0.15	1.72	ELXS201VSN561MP35S	820	35 × 40	0.15	2.57	ELXS3B1VSN821MA40S	
	560	25.4 × 25	0.15	1.67	ELXS201VSN561MQ25S	1,000	35 × 45	0.15	2.91	ELXS3B1VSN102MA45S	
	680	22 × 40	0.15	1.94	ELXS201VSN681MP40S	1,200	35 × 50	0.15	3.25	ELXS3B1VSN122MA50S	
	680	25.4 × 30	0.15	1.89	ELXS201VSN681MQ30S	120	22 × 25	0.15	0.77	ELXS401VSN121MP25S	
	680	30 × 25	0.15	2.06	ELXS201VSN681MR25S	150	22 × 30	0.15	0.90	ELXS401VSN151MP30S	
	820	22 × 45	0.15	2.17	ELXS201VSN821MP45S	180	22 × 35	0.15	1.02	ELXS401VSN181MP35S	
	820	25.4 × 35	0.15	2.17	ELXS201VSN821MQ35S	180	25.4 × 25	0.15	0.99	ELXS401VSN181MQ25S	
	1,000	22 × 50	0.15	2.45	ELXS201VSN102MP50S	220	22 × 40	0.15	1.15	ELXS401VSN221MP40S	
	1,000	25.4 × 40	0.15	2.45	ELXS201VSN102MQ40S	220	25.4 × 30	0.15	1.13	ELXS401VSN221MQ30S	
	1,000	30 × 30	0.15	2.52	ELXS201VSN102MR30S	220	30 × 25	0.15	1.17	ELXS401VSN221MQ25S	
	1,000	35 × 25	0.15	2.66	ELXS201VSN102MA25S	270	22 × 45	0.15	1.29	ELXS401VSN271MP45S	
	1,200	25.4 × 45	0.15	2.73	ELXS201VSN122MQ45S	270	22 × 50	0.15	1.32	ELXS401VSN271MP50S	
	1,200	25.4 × 50	0.15	2.78	ELXS201VSN122MQ50S	270	25.4 × 35	0.15	1.30	ELXS401VSN271MQ35S	
	1,200	30 × 35	0.15	2.83	ELXS201VSN122MR35S	330	25.4 × 40	0.15	1.47	ELXS401VSN331MQ40S	
	1,200	35 × 30	0.15	2.96	ELXS201VSN122MA30S	330	30 × 30	0.15	1.45	ELXS401VSN331MR30S	
	1,500	30 × 40	0.15	3.26	ELXS201VSN152MR40S	330	35 × 25	0.15	1.52	ELXS401VSN331MA25S	
	1,500	30 × 45	0.15	3.34	ELXS201VSN152MR45S	390	25.4 × 45	0.15	1.63	ELXS401VSN391MQ45S	

Product specifications in this catalog are subject to change without notice. Request our product specifications before purchase and/or use. Please use our products based on the information contained in this catalog and product specifications.

Return Group Chart



LARGE CAPACITANCE ALUMINUM ELECTROLYTIC CAPACITORS

Long life snap-ins, 105°C

LXS Upgrade! Series

◆STANDARD RATINGS

WV (V _{dc})	Cap (μF)	Case size φD×L(mm)	tan δ	Rated ripple current (Arms/105°C, 120Hz)	Part No.	WV (V _{dc})	Cap (μF)	Case size φD×L(mm)	tan δ	Rated ripple current (Arms/105°C, 120Hz)	Part No.
400	390	25.4 × 50	0.15	1.66	ELXS401VSN391MQ50S	450	180	22 × 45	0.20	1.06	ELXS451VSN181MP45S
	390	30 × 35	0.15	1.61	ELXS401VSN391MR35S		180	25.4 × 35	0.20	1.06	ELXS451VSN181MQ35S
	390	35 × 30	0.15	1.68	ELXS401VSN391MA30S		180	30 × 25	0.20	1.06	ELXS451VSN181MR25S
	470	30 × 40	0.15	1.82	ELXS401VSN471MR40S		220	22 × 50	0.20	1.20	ELXS451VSN221MP50S
	470	35 × 35	0.15	1.88	ELXS401VSN471MA35S		220	25.4 × 40	0.20	1.20	ELXS451VSN221MQ40S
	560	30 × 45	0.15	2.04	ELXS401VSN561MR45S		220	30 × 30	0.20	1.18	ELXS451VSN221MR30S
	560	30 × 50	0.15	2.07	ELXS401VSN561MR50S		220	35 × 25	0.20	1.24	ELXS451VSN221MA25S
	560	35 × 40	0.15	2.13	ELXS401VSN561MA40S		270	25.4 × 45	0.20	1.36	ELXS451VSN271MQ45S
	680	35 × 45	0.15	2.40	ELXS401VSN681MA45S		270	25.4 × 50	0.20	1.38	ELXS451VSN271MQ50S
	820	35 × 50	0.15	2.69	ELXS401VSN821MA50S		270	30 × 35	0.20	1.34	ELXS451VSN271MR35S
420	100	22 × 25	0.20	0.70	ELXS421VSN101MP25S	270	35 × 30	0.20	1.40	ELXS451VSN271MA30S	
	120	22 × 30	0.20	0.81	ELXS421VSN121MP30S	330	30 × 40	0.20	1.52	ELXS451VSN331MR40S	
	120	25.4 × 25	0.20	0.81	ELXS421VSN121MQ25S	390	30 × 45	0.20	1.70	ELXS451VSN391MR45S	
	150	22 × 35	0.20	0.93	ELXS421VSN151MP35S	390	30 × 50	0.20	1.73	ELXS451VSN391MR50S	
	180	22 × 40	0.20	1.04	ELXS421VSN181MP40S	390	35 × 35	0.20	1.71	ELXS451VSN391MA35S	
	180	25.4 × 30	0.20	1.02	ELXS421VSN181MQ30S	470	35 × 40	0.20	1.95	ELXS451VSN471MA40S	
	180	30 × 25	0.20	1.06	ELXS421VSN181MR25S	470	35 × 45	0.20	1.99	ELXS451VSN471MA45S	
	220	22 × 45	0.20	1.17	ELXS421VSN221MP45S	560	35 × 50	0.20	2.22	ELXS451VSN561MA50S	
	220	22 × 50	0.20	1.20	ELXS421VSN221MP50S	100	30 × 25	0.20	0.82	ELXS501VSN101MR25S	
	220	25.4 × 35	0.20	1.18	ELXS421VSN221MQ35S	120	30 × 30	0.20	0.91	ELXS501VSN121MR30S	
	270	25.4 × 40	0.20	1.33	ELXS421VSN271MQ40S	120	35 × 25	0.20	0.88	ELXS501VSN121MA25S	
	270	25.4 × 45	0.20	1.36	ELXS421VSN271MQ45S	150	30 × 35	0.20	1.04	ELXS501VSN151MR35S	
	270	30 × 30	0.20	1.31	ELXS421VSN271MR30S	180	30 × 40	0.20	1.17	ELXS501VSN181MR40S	
	270	35 × 25	0.20	1.38	ELXS421VSN271MA25S	180	35 × 30	0.20	1.10	ELXS501VSN181MA30S	
	330	25.4 × 50	0.20	1.52	ELXS421VSN331MQ50S	220	30 × 45	0.20	1.33	ELXS501VSN221MR45S	
	330	30 × 35	0.20	1.48	ELXS421VSN331MR35S	220	35 × 35	0.20	1.23	ELXS501VSN221MA35S	
	330	35 × 30	0.20	1.55	ELXS421VSN331MA30S	270	30 × 50	0.20	1.50	ELXS501VSN271MR50S	
	390	30 × 40	0.20	1.66	ELXS421VSN391MR40S	270	35 × 40	0.20	1.42	ELXS501VSN271MA40S	
	390	30 × 45	0.20	1.70	ELXS421VSN391MR45S	330	35 × 45	0.20	1.60	ELXS501VSN331MA45S	
	390	35 × 35	0.20	1.71	ELXS421VSN391MA35S	390	35 × 50	0.20	1.78	ELXS501VSN391MA50S	
470	30 × 50	0.20	1.90	ELXS421VSN471MR50S	470	35 × 60	0.20	2.03	ELXS501VSN471MA60S		
470	35 × 40	0.20	1.95	ELXS421VSN471MA40S	120	30 × 30	0.20	0.91	ELXS551VSN121MR30S		
560	35 × 45	0.20	2.17	ELXS421VSN561MA45S	150	30 × 35	0.20	1.04	ELXS551VSN151MR35S		
680	35 × 50	0.20	2.45	ELXS421VSN681MA50S	180	30 × 40	0.20	1.17	ELXS551VSN181MR40S		
450	82	22 × 25	0.20	0.64	ELXS451VSN820MP25S	180	35 × 30	0.20	1.10	ELXS551VSN181MA30S	
	120	22 × 30	0.20	0.81	ELXS451VSN121MP30S	220	30 × 50	0.20	1.35	ELXS551VSN221MR50S	
	120	22 × 35	0.20	0.83	ELXS451VSN121MP35S	220	35 × 40	0.20	1.28	ELXS551VSN221MA40S	
	120	25.4 × 25	0.20	0.81	ELXS451VSN121MQ25S	270	35 × 45	0.20	1.45	ELXS551VSN271MA45S	
	150	22 × 40	0.20	0.94	ELXS451VSN151MP40S	330	35 × 50	0.20	1.64	ELXS551VSN331MA50S	
	150	25.4 × 30	0.20	0.93	ELXS451VSN151MQ30S	390	35 × 60	0.20	1.85	ELXS551VSN391MA60S	

◆RATED RIPPLE CURRENT MULTIPLIERS

● Frequency Multipliers

Frequency(Hz)	50	120	300	1k	10k	50k
160 to 250V _{dc}	0.81	1.00	1.17	1.32	1.45	1.50
315 to 450V _{dc}	0.77	1.00	1.16	1.30	1.41	1.43
500, 550V _{dc}	0.70	1.00	1.16	1.30	1.41	1.43

The endurance of capacitors is reduced with internal heating produced by ripple current at the rate of halving the lifetime with every 5°C rise. When long life performance is required in actual use, the rms ripple current has to be reduced.

Return Group Chart



LARGE CAPACITANCE ALUMINUM ELECTROLYTIC CAPACITORS

Long life snap-ins, 105°C

LXQ Series

- Endurance with ripple current : 5,000 hours at 105°C
- Downsized and higher ripple version of LXG series
- Non solvent resistant type
- RoHS Compliant

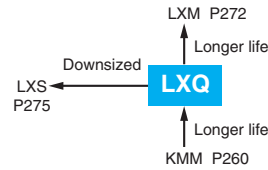

SPECIFICATIONS

Items	Characteristics		
Category	-25 to +105°C		
Temperature Range	-25 to +105°C		
Rated Voltage Range	160 to 450V _{dc}		
Capacitance Tolerance	±20% (M) (at 20°C, 120Hz)		
Leakage Current	$I \leq 3/CV$ Where, I : Max. leakage current (µA), C : Nominal capacitance (µF), V : Rated voltage (V) (at 20°C after 5 minutes)		
Dissipation Factor (tan δ)	Rated voltage (V _{dc})	160 to 400V	420 & 450V
	tan δ (Max.)	0.15	0.20
Low Temperature Characteristics (Max. Impedance Ratio)	Rated voltage (V _{dc})	160 to 400V	420 & 450V
	Z(-25°C)/Z(+20°C)	4	8
Endurance	The following specifications shall be satisfied when the capacitors are restored to 20°C after subjected to DC voltage with the rated ripple current is applied (the peak voltage shall not exceed the rated voltage) for 5,000 hours at 105°C.		
	Capacitance change	≤ ±20% of the initial value	
	D.F. (tan δ)	≤ 200% of the initial specified value	
	Leakage current	≤ The initial specified value	
Shelf Life	The following specifications shall be satisfied when the capacitors are restored to 20°C after exposing them for 1,000 hours at 105°C without voltage applied. Before the measurement, the capacitor shall be preconditioned by applying voltage according to Item 4.1 of JIS C 5101-4.		
	Capacitance change	≤ ±15% of the initial value	
	D.F. (tan δ)	≤ 150% of the initial specified value	
	Leakage current	≤ The initial specified value	

DIMENSIONS [mm]

● Terminal Code : VS (φ22 to φ35) : Standard

● Terminal Code : LI (φ30, φ35)

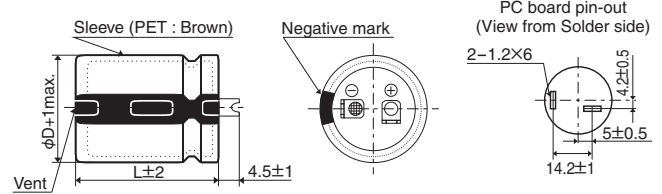
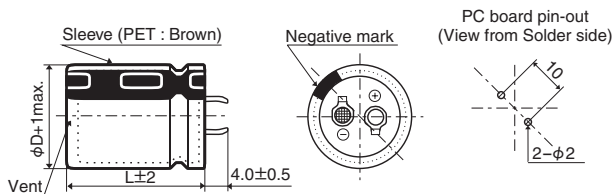

The standard design has no plastic disc.

PART NUMBERING SYSTEM

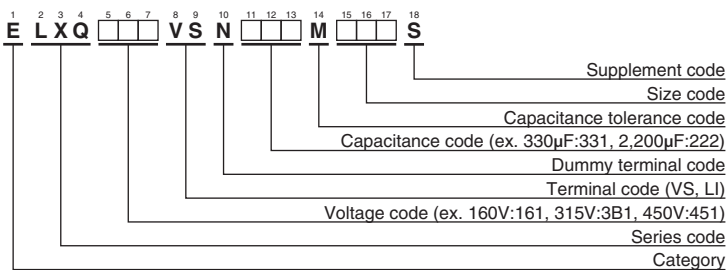

Please refer to "Product code guide (snap-in type)"

Return Group Chart



LARGE CAPACITANCE ALUMINUM ELECTROLYTIC CAPACITORS

Long life snap-ins, 105°C

LXQ Series

◆STANDARD RATINGS

WV (V _{dc})	Cap (μF)	Case size φD×L(mm)	tan δ	Rated ripple current (Arms/ 105°C, 120Hz)	Part No.	WV (V _{dc})	Cap (μF)	Case size φD×L(mm)	tan δ	Rated ripple current (Arms/ 105°C, 120Hz)	Part No.
160	390	22 × 25	0.15	1.32	ELXQ161VSN391MP25S	200	1,200	30 × 50	0.15	2.88	ELXQ201VSN122MR50S
	560	22 × 30	0.15	1.66	ELXQ161VSN561MP30S		1,200	35 × 35	0.15	2.88	ELXQ201VSN122MA35S
	560	25.4 × 25	0.15	1.68	ELXQ161VSN561MQ25S		1,500	35 × 40	0.15	3.34	ELXQ201VSN152MA40S
	680	22 × 35	0.15	1.87	ELXQ161VSN681MP35S		1,800	35 × 45	0.15	3.74	ELXQ201VSN182MA45S
	680	25.4 × 30	0.15	1.88	ELXQ161VSN681MQ30S		1,800	35 × 50	0.15	3.82	ELXQ201VSN182MA50S
	680	30 × 25	0.15	1.96	ELXQ161VSN681MR25S		270	22 × 25	0.15	1.10	ELXQ221VSN271MP25S
	820	22 × 40	0.15	2.09	ELXQ161VSN821MP40S		330	22 × 30	0.15	1.19	ELXQ221VSN331MP30S
	1,000	22 × 45	0.15	2.36	ELXQ161VSN102MP45S		390	25.4 × 25	0.15	1.39	ELXQ221VSN391MQ25S
	1,000	22 × 50	0.15	2.41	ELXQ161VSN102MP50S		470	22 × 35	0.15	1.55	ELXQ221VSN471MP35S
	1,000	25.4 × 35	0.15	2.38	ELXQ161VSN102MQ35S		470	25.4 × 30	0.15	1.56	ELXQ221VSN471MQ30S
	1,000	30 × 30	0.15	2.40	ELXQ161VSN102MR30S		470	30 × 25	0.15	1.63	ELXQ221VSN471MR25S
	1,000	35 × 25	0.15	2.55	ELXQ161VSN102MA25S		560	22 × 40	0.15	1.73	ELXQ221VSN561MP40S
	1,200	25.4 × 40	0.15	2.66	ELXQ161VSN122MQ40S		560	30 × 30	0.15	1.79	ELXQ221VSN561MR30S
	1,200	25.4 × 45	0.15	2.71	ELXQ161VSN122MQ45S		680	22 × 45	0.15	1.94	ELXQ221VSN681MP45S
	1,200	30 × 35	0.15	2.69	ELXQ161VSN122MR35S		680	22 × 50	0.15	1.99	ELXQ221VSN681MR50S
	1,200	30 × 40	0.15	2.77	ELXQ161VSN122MR40S		680	25.4 × 35	0.15	1.96	ELXQ221VSN681MQ35S
	1,200	35 × 30	0.15	2.86	ELXQ161VSN122MA30S		680	30 × 35	0.15	2.02	ELXQ221VSN681MP35S
	1,500	25.4 × 50	0.15	3.08	ELXQ161VSN152MQ50S		680	35 × 25	0.15	2.10	ELXQ221VSN681MA25S
	1,500	30 × 45	0.15	3.17	ELXQ161VSN152MR45S		820	25.4 × 40	0.15	2.20	ELXQ221VSN821MQ40S
	1,500	35 × 35	0.15	3.22	ELXQ161VSN152MA35S		820	25.4 × 45	0.15	2.24	ELXQ221VSN821MQ45S
	1,800	30 × 50	0.15	3.53	ELXQ161VSN182MR50S		820	30 × 40	0.15	2.29	ELXQ221VSN821MR40S
1,800	35 × 40	0.15	3.66	ELXQ161VSN182MA40S	820	35 × 30	0.15	2.36	ELXQ221VSN821MA30S		
2,200	35 × 45	0.15	4.14	ELXQ161VSN222MA45S	1,000	25.4 × 50	0.15	2.51	ELXQ221VSN102MQ50S		
2,700	35 × 50	0.15	4.68	ELXQ161VSN272MA50S	1,000	30 × 45	0.15	2.59	ELXQ221VSN102MR45S		
180	330	22 × 25	0.15	1.21	ELXQ181VSN331MP25S	1,000	35 × 35	0.15	2.63	ELXQ221VSN102MA35S	
	470	22 × 30	0.15	1.52	ELXQ181VSN471MP30S	1,200	30 × 50	0.15	2.88	ELXQ221VSN122MR50S	
	470	25.4 × 25	0.15	1.52	ELXQ181VSN471MQ25S	1,200	35 × 40	0.15	2.98	ELXQ221VSN122MA40S	
	560	22 × 35	0.15	1.70	ELXQ181VSN561MP35S	1,500	35 × 45	0.15	3.41	ELXQ221VSN152MA45S	
	560	30 × 25	0.15	1.78	ELXQ181VSN561MR25S	1,800	35 × 50	0.15	3.82	ELXQ221VSN182MA50S	
	680	22 × 40	0.15	1.91	ELXQ181VSN681MP40S	220	22 × 25	0.15	1.01	ELXQ251VSN221MP25S	
	680	25.4 × 30	0.15	1.88	ELXQ181VSN681MQ30S	270	22 × 30	0.15	1.20	ELXQ251VSN271MP30S	
	820	22 × 45	0.15	1.99	ELXQ181VSN821MP45S	330	25.4 × 25	0.15	1.32	ELXQ251VSN331MQ25S	
	820	25.4 × 35	0.15	2.16	ELXQ181VSN821MQ35S	390	22 × 35	0.15	1.44	ELXQ251VSN391MP35S	
	820	30 × 30	0.15	2.17	ELXQ181VSN821MR30S	390	25.4 × 30	0.15	1.43	ELXQ251VSN391MQ30S	
	820	35 × 25	0.15	2.31	ELXQ181VSN821MA25S	390	30 × 25	0.15	1.51	ELXQ251VSN391MR25S	
	1,000	22 × 50	0.15	2.25	ELXQ181VSN102MP50S	470	22 × 40	0.15	1.62	ELXQ251VSN471MP40S	
	1,000	25.4 × 40	0.15	2.43	ELXQ181VSN102MQ40S	560	22 × 45	0.15	1.80	ELXQ251VSN561MP45S	
	1,000	25.4 × 45	0.15	2.47	ELXQ181VSN102MQ45S	560	22 × 50	0.15	1.84	ELXQ251VSN561MP50S	
	1,000	30 × 35	0.15	2.46	ELXQ181VSN102MR35S	560	25.4 × 35	0.15	1.78	ELXQ251VSN561MQ35S	
	1,200	25.4 × 50	0.15	2.75	ELXQ181VSN122MQ50S	560	30 × 30	0.15	1.83	ELXQ251VSN561MR30S	
	1,200	30 × 40	0.15	2.77	ELXQ181VSN122MR40S	560	35 × 25	0.15	1.91	ELXQ251VSN561MA25S	
	1,200	35 × 30	0.15	2.86	ELXQ181VSN122MA30S	680	25.4 × 40	0.15	2.00	ELXQ251VSN681MQ40S	
	1,500	30 × 45	0.15	3.17	ELXQ181VSN152MR45S	680	25.4 × 45	0.15	2.04	ELXQ251VSN681MQ45S	
	1,500	30 × 50	0.15	3.22	ELXQ181VSN152MR50S	680	30 × 35	0.15	2.06	ELXQ251VSN681MR35S	
	1,500	35 × 35	0.15	3.22	ELXQ181VSN152MA35S	680	35 × 30	0.15	2.15	ELXQ251VSN681MA30S	
1,800	35 × 40	0.15	3.66	ELXQ181VSN182MA40S	820	25.4 × 50	0.15	2.28	ELXQ251VSN821MQ50S		
1,800	35 × 45	0.15	3.74	ELXQ181VSN182MA45S	820	30 × 40	0.15	2.33	ELXQ251VSN821MR40S		
2,200	35 × 50	0.15	4.22	ELXQ181VSN222MA50S	820	30 × 45	0.15	2.39	ELXQ251VSN821MR45S		
200	270	22 × 25	0.15	1.10	ELXQ201VSN271MP25S	820	35 × 35	0.15	2.38	ELXQ251VSN821MA35S	
	390	22 × 30	0.15	1.38	ELXQ201VSN391MP30S	1,000	30 × 50	0.15	2.68	ELXQ251VSN102MR50S	
	390	25.4 × 25	0.15	1.39	ELXQ201VSN391MQ25S	1,000	35 × 40	0.15	2.72	ELXQ251VSN102MA40S	
	470	22 × 35	0.15	1.55	ELXQ201VSN471MP35S	1,200	35 × 45	0.15	3.05	ELXQ251VSN122MA45S	
	560	22 × 40	0.15	1.73	ELXQ201VSN561MP40S	1,500	35 × 50	0.15	3.49	ELXQ251VSN152MA50S	
	560	25.4 × 30	0.15	1.71	ELXQ201VSN561MQ30S	150	22 × 25	0.15	0.80	ELXQ3B1VSN151MP25S	
	560	30 × 25	0.15	1.78	ELXQ201VSN561MR25S	180	22 × 30	0.15	0.92	ELXQ3B1VSN181MP30S	
	680	22 × 45	0.15	1.81	ELXQ201VSN681MP45S	180	25.4 × 25	0.15	0.94	ELXQ3B1VSN181MQ25S	
	680	25.4 × 35	0.15	1.87	ELXQ201VSN681MQ35S	220	22 × 35	0.15	1.04	ELXQ3B1VSN221MP35S	
	680	30 × 30	0.15	1.98	ELXQ201VSN681MR30S	220	30 × 25	0.15	1.17	ELXQ3B1VSN221MR25S	
	680	35 × 25	0.15	2.10	ELXQ201VSN681MA25S	270	22 × 40	0.15	1.18	ELXQ3B1VSN271MP40S	
	820	22 × 50	0.15	2.18	ELXQ201VSN821MP50S	270	25.4 × 30	0.15	1.19	ELXQ3B1VSN271MQ30S	
	820	25.4 × 40	0.15	2.09	ELXQ201VSN821MQ40S	330	22 × 45	0.15	1.33	ELXQ3B1VSN331MP45S	
	820	30 × 35	0.15	2.22	ELXQ201VSN821MR35S	330	25.4 × 35	0.15	1.37	ELXQ3B1VSN331MQ35S	
	1,000	25.4 × 45	0.15	2.35	ELXQ201VSN102MQ45S	330	30 × 30	0.15	1.40	ELXQ3B1VSN331MR30S	
	1,000	25.4 × 50	0.15	2.39	ELXQ201VSN102MQ50S	330	35 × 25	0.15	1.49	ELXQ3B1VSN331MA25S	
	1,000	30 × 40	0.15	2.53	ELXQ201VSN102MR40S	390	22 × 50	0.15	1.48	ELXQ3B1VSN391MP50S	
	1,000	35 × 30	0.15	2.61	ELXQ201VSN102MA30S	390	25.4 × 40	0.15	1.52	ELXQ3B1VSN391MQ40S	
	1,200	30 × 45	0.15	2.84	ELXQ201VSN122MR45S	470	25.4 × 45	0.15	1.70	ELXQ3B1VSN471MQ45S	

Product specifications in this catalog are subject to change without notice. Request our product specifications before purchase and/or use. Please use our products based on the information contained in this catalog and product specifications.

Return Group Chart



LARGE CAPACITANCE ALUMINUM ELECTROLYTIC CAPACITORS

Long life snap-ins, 105°C



◆ STANDARD RATINGS

WV (V _{dc})	Cap (μF)	Case size φD×L(mm)	tan δ	Rated ripple current (Arms/ 105°C, 120Hz)	Part No.	WV (V _{dc})	Cap (μF)	Case size φD×L(mm)	tan δ	Rated ripple current (Arms/ 105°C, 120Hz)	Part No.	
315	470	30 × 35	0.15	1.71	ELXQ3B1VSN471MR35S	400	470	30 × 45	0.15	1.81	ELXQ401VSN471MR45S	
	470	35 × 30	0.15	1.82	ELXQ3B1VSN471MA30S		470	30 × 50	0.15	1.84	ELXQ401VSN471MR50S	
	560	25.4 × 50	0.15	1.88	ELXQ3B1VSN561MQ50S		470	35 × 40	0.15	1.90	ELXQ401VSN471MA40S	
	560	30 × 40	0.15	1.92	ELXQ3B1VSN561MR40S		560	35 × 45	0.15	2.12	ELXQ401VSN561MA45S	
	560	30 × 45	0.15	1.97	ELXQ3B1VSN561MR45S		680	35 × 50	0.15	2.39	ELXQ401VSN681MA50S	
	560	35 × 35	0.15	2.00	ELXQ3B1VSN561MA35S		420	100	22 × 25	0.20	0.66	ELXQ421VSN101MP25S
	680	30 × 50	0.15	2.21	ELXQ3B1VSN681MR50S			120	22 × 30	0.20	0.75	ELXQ421VSN121MP30S
	680	35 × 40	0.15	2.29	ELXQ3B1VSN681MA40S			120	25.4 × 25	0.20	0.77	ELXQ421VSN121MQ25S
	820	35 × 45	0.15	2.57	ELXQ3B1VSN821MA45S			150	22 × 35	0.20	0.86	ELXQ421VSN151MP35S
	1,000	35 × 50	0.15	2.89	ELXQ3B1VSN102MA50S			180	22 × 40	0.20	0.96	ELXQ421VSN181MP40S
350	120	22 × 25	0.15	0.72	ELXQ351VSN121MP25S	180		22 × 45	0.20	0.98	ELXQ421VSN181MP45S	
	150	22 × 30	0.15	0.84	ELXQ351VSN151MP30S	180		25.4 × 30	0.20	0.97	ELXQ421VSN181MQ30S	
	180	25.4 × 25	0.15	0.94	ELXQ351VSN181MQ25S	180		25.4 × 35	0.20	1.01	ELXQ421VSN181MQ35S	
	220	22 × 35	0.15	1.04	ELXQ351VSN221MP35S	180		30 × 25	0.20	1.02	ELXQ421VSN181MR25S	
	220	22 × 40	0.15	1.06	ELXQ351VSN221MP40S	220		22 × 50	0.20	1.11	ELXQ421VSN221MP50S	
	220	25.4 × 30	0.15	1.07	ELXQ351VSN221MQ30S	220	25.4 × 40	0.20	1.14	ELXQ421VSN221MQ40S		
	220	30 × 25	0.15	1.13	ELXQ351VSN221MR25S	220	30 × 30	0.20	1.14	ELXQ421VSN221MP30S		
	270	22 × 45	0.15	1.20	ELXQ351VSN271MP45S	220	35 × 25	0.20	1.22	ELXQ421VSN221MA25S		
	270	25.4 × 35	0.15	1.24	ELXQ351VSN271MQ35S	270	25.4 × 45	0.20	1.29	ELXQ421VSN271MQ45S		
	270	30 × 30	0.15	1.27	ELXQ351VSN271MR30S	270	30 × 35	0.20	1.30	ELXQ421VSN271MR35S		
400	270	35 × 25	0.15	1.35	ELXQ351VSN271MA25S	270	35 × 30	0.20	1.38	ELXQ421VSN271MA30S		
	330	22 × 50	0.15	1.36	ELXQ351VSN331MP50S	330	25.4 × 50	0.20	1.44	ELXQ421VSN331MQ50S		
	330	25.4 × 40	0.15	1.39	ELXQ351VSN331MQ40S	330	30 × 40	0.20	1.48	ELXQ421VSN331MP40S		
	330	30 × 35	0.15	1.43	ELXQ351VSN331MR35S	330	35 × 35	0.20	1.54	ELXQ421VSN331MA35S		
	390	25.4 × 45	0.15	1.55	ELXQ351VSN391MQ45S	390	30 × 45	0.20	1.64	ELXQ421VSN391MR45S		
	390	30 × 40	0.15	1.60	ELXQ351VSN391MR40S	390	35 × 40	0.20	1.73	ELXQ421VSN391MA40S		
	390	35 × 30	0.15	1.66	ELXQ351VSN391MA30S	470	30 × 50	0.20	1.84	ELXQ421VSN471MR50S		
	470	25.4 × 50	0.15	1.72	ELXQ351VSN471MQ50S	470	35 × 45	0.20	1.94	ELXQ421VSN471MA45S		
	470	30 × 45	0.15	1.81	ELXQ351VSN471MR45S	560	35 × 50	0.20	2.17	ELXQ421VSN561MA50S		
	470	35 × 35	0.15	1.83	ELXQ351VSN471MA35S	450	82	22 × 25	0.20	0.59	ELXQ451VSN820MP25S	
560	30 × 50	0.15	2.00	ELXQ351VSN561MQ50S	100		22 × 30	0.20	0.69	ELXQ451VSN101MP30S		
560	35 × 40	0.15	2.07	ELXQ351VSN561MA40S	100		25.4 × 25	0.20	0.70	ELXQ451VSN101MQ25S		
680	35 × 45	0.15	2.34	ELXQ351VSN681MA45S	120		22 × 35	0.20	0.77	ELXQ451VSN121MP35S		
820	35 × 50	0.15	2.62	ELXQ351VSN821MA50S	150		22 × 40	0.20	0.88	ELXQ451VSN151MP40S		
400	100	22 × 25	0.15	0.66	ELXQ401VSN101MP25S		150	22 × 45	0.20	0.90	ELXQ451VSN151MP45S	
	120	22 × 30	0.15	0.75	ELXQ401VSN121MP30S		150	25.4 × 30	0.20	0.88	ELXQ451VSN151MQ30S	
	150	22 × 35	0.15	0.86	ELXQ401VSN151MP35S		150	25.4 × 35	0.20	0.92	ELXQ451VSN151MQ35S	
	150	25.4 × 25	0.15	0.86	ELXQ401VSN151MQ25S		150	30 × 25	0.20	0.93	ELXQ451VSN151MR25S	
	180	22 × 40	0.15	0.96	ELXQ401VSN181MP40S		180	22 × 50	0.20	1.01	ELXQ451VSN181MP50S	
	180	25.4 × 30	0.15	0.97	ELXQ401VSN181MQ30S	180	25.4 × 40	0.20	1.03	ELXQ451VSN181MQ40S		
	180	30 × 25	0.15	1.02	ELXQ401VSN181MR25S	180	30 × 30	0.20	1.03	ELXQ451VSN181MR30S		
	220	22 × 45	0.15	1.09	ELXQ401VSN221MP45S	180	35 × 25	0.20	1.10	ELXQ451VSN181MA25S		
	220	25.4 × 35	0.15	1.12	ELXQ401VSN221MQ35S	220	25.4 × 45	0.20	1.16	ELXQ451VSN221MQ45S		
	220	35 × 25	0.15	1.22	ELXQ401VSN221MA25S	220	30 × 35	0.20	1.17	ELXQ451VSN221MR35S		
400	270	22 × 50	0.15	1.23	ELXQ401VSN271MP50S	220	35 × 30	0.20	1.24	ELXQ451VSN221MA30S		
	270	25.4 × 40	0.15	1.26	ELXQ401VSN271MQ40S	270	25.4 × 50	0.20	1.31	ELXQ451VSN271MQ50S		
	270	25.4 × 45	0.15	1.29	ELXQ401VSN271MQ45S	270	30 × 40	0.20	1.33	ELXQ451VSN271MR40S		
	270	30 × 30	0.15	1.27	ELXQ401VSN271MR30S	270	35 × 35	0.20	1.39	ELXQ451VSN271MA35S		
	330	25.4 × 50	0.15	1.44	ELXQ401VSN331MQ50S	330	30 × 45	0.20	1.51	ELXQ451VSN331MR45S		
	330	30 × 35	0.15	1.43	ELXQ401VSN331MR35S	390	30 × 50	0.20	1.67	ELXQ451VSN391MR50S		
	330	35 × 30	0.15	1.52	ELXQ401VSN331MA30S	390	35 × 40	0.20	1.73	ELXQ451VSN391MA40S		
	390	30 × 40	0.15	1.60	ELXQ401VSN391MR40S	390	35 × 45	0.20	1.77	ELXQ451VSN391MA45S		
	390	35 × 35	0.15	1.67	ELXQ401VSN391MA35S	470	35 × 50	0.20	1.98	ELXQ451VSN471MA50S		

◆ RATED RIPPLE CURRENT MULTIPLIERS

● Frequency Multipliers

Frequency(Hz)	50	120	300	1k	10k	50k
160 to 250V _{dc}	0.81	1.00	1.17	1.32	1.45	1.50
315 to 450V _{dc}	0.77	1.00	1.16	1.30	1.41	1.43

The endurance of capacitors is reduced with internal heating produced by ripple current at the rate of halving the lifetime with every 5°C rise. When long life performance is required in actual use, the rms ripple current has to be reduced.

Return Group Chart



LARGE CAPACITANCE ALUMINUM ELECTROLYTIC CAPACITORS

Long life snap-ins, 105°C

LXG Series

- Endurance with ripple current : 5,000 hours at 105°C
- Non solvent resistant type
- RoHS Compliant



SPECIFICATIONS

Items	Characteristics								
Category	-40 to +105°C								
Temperature Range	-40 to +105°C								
Rated Voltage Range	10 to 100V _{dc}								
Capacitance Tolerance	±20% (M) (at 20°C, 120Hz)								
Leakage Current	I=0.02CV or 3mA, whichever is smaller. Where, I : Max. leakage current (μA), C : Nominal capacitance (μF), V : Rated voltage (V) (at 20°C after 5 minutes)								
Dissipation Factor (tan δ)	Rated voltage (V _{dc})	10V	16V	25V	35V	50V	63V	80 & 100V	(at 20°C, 120Hz)
	tan δ (Max.)	0.60	0.45	0.30	0.25	0.20	0.15	0.15	
Low Temperature Characteristics (Max. Impedance Ratio)	Capacitance change : Capacitance at the lowest operating temperature shall not be less than 70% of the 20°C value.								
	Rated voltage (V _{dc})	10V	16V	25V	35V	50V	63V	80 & 100V	(at 120Hz)
	Z(-25°C)/Z(+20°C)	4	4	3	3	2	2	2	
Z(-40°C)/Z(+20°C)	15	15	10	8	6	6	5		
Endurance	The following specifications shall be satisfied when the capacitors are restored to 20°C after subjected to DC voltage with rated ripple current is applied (the peak voltage shall not exceed the rated voltage) for 5,000 hours at 105°C.								
	Capacitance change	≤ ±25% of the initial value							
	D.F. (tan δ)	≤250% of the initial specified value							
	Leakage current	≤The initial specified value							
Shelf Life	The following specifications shall be satisfied when the capacitors are restored to 20°C after exposing them for 500 hours at 105°C without voltage applied. Before the measurement, the capacitor shall be preconditioned by applying voltage according to Item 4.1 of JIS C 5101-4.								
	Capacitance change	≤ ±20% of the initial value							
	D.F. (tan δ)	≤150% of the initial specified value							
	Leakage current	≤The initial specified value							

DIMENSIONS [mm]

Terminal Code : VS (φ22 to φ35) : Standard

Terminal Code : LI (φ35)

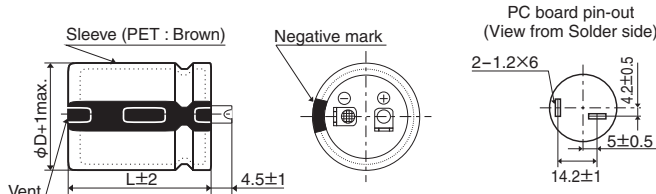
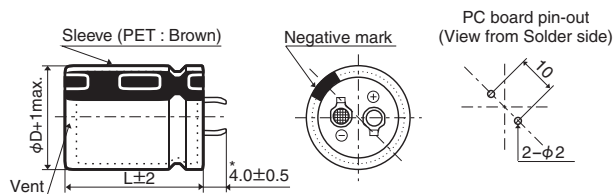

*φD=35mm : 3.5±0.5mm

The standard design has no plastic disc.

PART NUMBERING SYSTEM

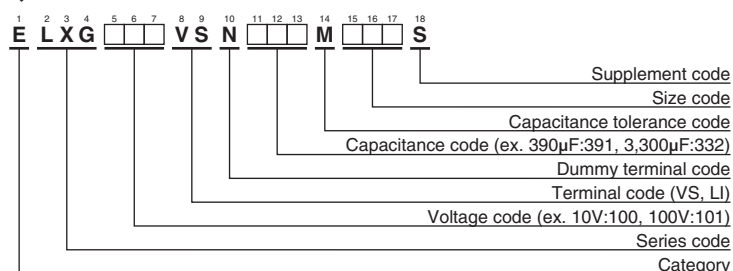

Please refer to "Product code guide (snap-in type)"

RATED RIPPLE CURRENT MULTIPLIERS

Frequency Multipliers

Frequency(Hz)	50	120	300	1k	10k	50k
10 to 50V _{dc}	0.95	1.00	1.03	1.05	1.08	1.08
63 to 100V _{dc}	0.92	1.00	1.07	1.13	1.19	1.20

The endurance of capacitors is reduced with internal heating produced by ripple current at the rate of halving the lifetime with every 5°C rise. When long life performance is required in actual use, the rms ripple current has to be reduced.

Return Group Chart



LARGE CAPACITANCE ALUMINUM ELECTROLYTIC CAPACITORS

Long life snap-ins, 105°C

LXG Series

◆STANDARD RATINGS

WV (V _{dc})	Cap (μF)	Case size φD×L(mm)	tan δ	Rated ripple current (Arms/105°C, 120Hz)		Part No.	WV (V _{dc})	Cap (μF)	Case size φD×L(mm)	tan δ	Rated ripple current (Arms/105°C, 120Hz)		Part No.
				Arms/105°C, 120Hz	Part No.						Arms/105°C, 120Hz	Part No.	
10	6,800	22 × 25	0.60	1.30	ELXG100VSN682MP25S	35	5,600	25.4 × 35	0.25	1.98	ELXG350VSN562MQ35S		
	10,000	22 × 30	0.60	1.65	ELXG100VSN103MP30S		5,600	30 × 30	0.25	1.98	ELXG350VSN562MR30S		
	10,000	25.4 × 25	0.60	1.64	ELXG100VSN103MQ25S		5,600	35 × 25	0.25	2.03	ELXG350VSN562MA25S		
	12,000	22 × 35	0.60	1.85	ELXG100VSN123MP35S		6,800	22 × 50	0.25	2.26	ELXG350VSN682MP50S		
	12,000	25.4 × 30	0.60	1.85	ELXG100VSN123MQ30S		6,800	25.4 × 40	0.25	2.24	ELXG350VSN682MQ40S		
	12,000	30 × 25	0.60	1.89	ELXG100VSN123MR25S		8,200	25.4 × 50	0.25	2.57	ELXG350VSN822MQ50S		
	15,000	22 × 40	0.60	2.12	ELXG100VSN153MP40S		8,200	30 × 35	0.25	2.50	ELXG350VSN822MR35S		
	15,000	25.4 × 35	0.60	2.16	ELXG100VSN153MQ35S		8,200	35 × 30	0.25	2.55	ELXG350VSN822MA30S		
	18,000	22 × 50	0.60	2.45	ELXG100VSN183MP50S		10,000	30 × 40	0.25	2.86	ELXG350VSN103MR40S		
	18,000	25.4 × 40	0.60	2.43	ELXG100VSN183MQ40S		10,000	35 × 35	0.25	2.88	ELXG350VSN103MA35S		
	18,000	30 × 30	0.60	2.37	ELXG100VSN183MR30S		12,000	30 × 50	0.25	3.32	ELXG350VSN123MR50S		
	18,000	35 × 25	0.60	2.42	ELXG100VSN183MA25S		12,000	35 × 40	0.25	3.30	ELXG350VSN123MA40S		
	22,000	30 × 35	0.60	2.73	ELXG100VSN223MR35S		18,000	35 × 50	0.25	4.29	ELXG350VSN183MA50S		
	22,000	35 × 30	0.60	2.79	ELXG100VSN223MA30S		50	1,500	22 × 25	0.20	1.02	ELXG500VSN152MP25S	
	27,000	25.4 × 50	0.60	3.11	ELXG100VSN273MQ50S			1,800	22 × 30	0.20	1.17	ELXG500VSN182MP30S	
	27,000	30 × 40	0.60	3.13	ELXG100VSN273MR40S			1,800	25.4 × 25	0.20	1.17	ELXG500VSN182MQ25S	
	33,000	35 × 35	0.60	3.49	ELXG100VSN333MA35S			2,200	22 × 35	0.20	1.33	ELXG500VSN222MP35S	
	39,000	30 × 50	0.60	3.99	ELXG100VSN393MR50S			2,700	22 × 40	0.20	1.51	ELXG500VSN272MP40S	
	39,000	35 × 40	0.60	3.96	ELXG100VSN393MA40S			2,700	25.4 × 30	0.20	1.47	ELXG500VSN272MQ30S	
	47,000	35 × 50	0.60	4.62	ELXG100VSN473MA50S			2,700	30 × 25	0.20	1.50	ELXG500VSN272MR25S	
	16	5,600	22 × 25	0.45	1.44			ELXG160VSN562MP25S	3,300	25.4 × 35	0.20	1.70	ELXG500VSN332MQ35S
6,800		22 × 30	0.45	1.66	ELXG160VSN682MP30S	3,300		30 × 30	0.20	1.70	ELXG500VSN332MR30S		
6,800		25.4 × 25	0.45	1.66	ELXG160VSN682MQ25S	3,300		35 × 25	0.20	1.74	ELXG500VSN332MA25S		
8,200		22 × 35	0.45	1.87	ELXG160VSN822MP35S	3,900		22 × 50	0.20	1.91	ELXG500VSN392MP50S		
10,000		22 × 40	0.45	2.12	ELXG160VSN103MP40S	3,900		25.4 × 40	0.20	1.89	ELXG500VSN392MQ40S		
10,000		25.4 × 30	0.45	2.07	ELXG160VSN103MQ30S	4,700		30 × 35	0.20	2.11	ELXG500VSN472MR35S		
10,000		30 × 25	0.45	2.11	ELXG160VSN103MR25S	4,700		35 × 30	0.20	2.16	ELXG500VSN472MA30S		
12,000		25.4 × 35	0.45	2.37	ELXG160VSN123MQ35S	5,600		25.4 × 50	0.20	2.38	ELXG500VSN562MQ50S		
12,000		30 × 30	0.45	2.37	ELXG160VSN123MR30S	5,600		30 × 40	0.20	2.39	ELXG500VSN562MR40S		
12,000		35 × 25	0.45	2.42	ELXG160VSN123MA25S	5,600		35 × 35	0.20	2.41	ELXG500VSN562MA35S		
15,000		22 × 50	0.45	2.74	ELXG160VSN153MP50S	6,800	30 × 50	0.20	2.79	ELXG500VSN682MR50S			
15,000		25.4 × 40	0.45	2.71	ELXG160VSN153MQ40S	6,800	35 × 40	0.20	2.78	ELXG500VSN682MA40S			
18,000		25.4 × 50	0.45	3.11	ELXG160VSN183MQ50S	10,000	35 × 50	0.20	3.57	ELXG500VSN103MA50S			
18,000		30 × 35	0.45	3.02	ELXG160VSN183MR35S	63	1,000	22 × 25	0.15	1.00	ELXG630VSN102MP25S		
18,000		35 × 30	0.45	3.09	ELXG160VSN183MA30S		1,200	22 × 30	0.15	1.15	ELXG630VSN122MP30S		
22,000		30 × 40	0.45	3.46	ELXG160VSN223MR40S		1,200	25.4 × 25	0.15	1.15	ELXG630VSN122MQ25S		
22,000		35 × 35	0.45	3.49	ELXG160VSN223MA35S		1,500	22 × 35	0.15	1.32	ELXG630VSN152MP35S		
27,000		30 × 50	0.45	4.07	ELXG160VSN273MR50S		1,800	22 × 40	0.15	1.49	ELXG630VSN182MP40S		
27,000		35 × 40	0.45	4.04	ELXG160VSN273MA40S		1,800	25.4 × 30	0.15	1.45	ELXG630VSN182MQ30S		
39,000		35 × 50	0.45	5.16	ELXG160VSN393MA50S		1,800	30 × 25	0.15	1.48	ELXG630VSN182MR25S		
25		3,900	22 × 25	0.30	1.31		ELXG250VSN392MP25S	2,200	25.4 × 35	0.15	1.67	ELXG630VSN222MQ35S	
	4,700	22 × 30	0.30	1.51	ELXG250VSN472MP30S		2,200	30 × 30	0.15	1.68	ELXG630VSN222MR30S		
	4,700	25.4 × 25	0.30	1.51	ELXG250VSN472MQ25S		2,200	35 × 25	0.15	1.71	ELXG630VSN222MA25S		
	5,600	22 × 35	0.30	1.70	ELXG250VSN562MP35S		2,700	22 × 50	0.15	1.92	ELXG630VSN272MP50S		
	6,800	22 × 40	0.30	1.92	ELXG250VSN682MP40S		2,700	25.4 × 40	0.15	1.90	ELXG630VSN272MQ40S		
	6,800	25.4 × 30	0.30	1.87	ELXG250VSN682MQ30S		2,700	30 × 35	0.15	1.93	ELXG630VSN272MR35S		
	6,800	30 × 25	0.30	1.90	ELXG250VSN682MR25S		3,300	25.4 × 50	0.15	2.20	ELXG630VSN332MQ50S		
	8,200	25.4 × 35	0.30	2.14	ELXG250VSN822MQ35S		3,300	35 × 30	0.15	2.18	ELXG630VSN332MA30S		
	8,200	30 × 30	0.30	2.15	ELXG250VSN822MR30S		3,900	30 × 40	0.15	2.41	ELXG630VSN392MR40S		
	8,200	35 × 25	0.30	2.19	ELXG250VSN822MA25S		3,900	35 × 35	0.15	2.43	ELXG630VSN392MA35S		
	10,000	22 × 50	0.30	2.45	ELXG250VSN103MP50S	4,700	30 × 50	0.15	2.80	ELXG630VSN472MR50S			
	10,000	25.4 × 40	0.30	2.43	ELXG250VSN103MQ40S	4,700	35 × 40	0.15	2.78	ELXG630VSN472MA40S			
	12,000	25.4 × 50	0.30	2.78	ELXG250VSN123MQ50S	6,800	35 × 50	0.15	3.55	ELXG630VSN682MA50S			
	12,000	30 × 35	0.30	2.70	ELXG250VSN123MR35S	80	680	22 × 25	0.15	0.97	ELXG800VSN681MP25S		
	12,000	35 × 30	0.30	2.76	ELXG250VSN123MA30S		820	22 × 30	0.15	1.12	ELXG800VSN821MP30S		
	15,000	30 × 40	0.30	3.13	ELXG250VSN153MR40S		1,000	22 × 35	0.15	1.27	ELXG800VSN102MP35S		
	15,000	35 × 35	0.30	3.16	ELXG250VSN153MA35S		1,000	25.4 × 25	0.15	1.23	ELXG800VSN102MQ25S		
	18,000	30 × 50	0.30	3.64	ELXG250VSN183MR50S		1,200	22 × 40	0.15	1.42	ELXG800VSN122MP40S		
	18,000	35 × 40	0.30	3.61	ELXG250VSN183MA40S		1,200	25.4 × 30	0.15	1.39	ELXG800VSN122MQ30S		
	27,000	35 × 50	0.30	4.70	ELXG250VSN273MA50S		1,200	30 × 25	0.15	1.41	ELXG800VSN122MR25S		
	35	2,200	22 × 25	0.25	1.10		ELXG350VSN222MP25S	1,500	25.4 × 35	0.15	1.62	ELXG800VSN152MQ35S	
3,300		22 × 30	0.25	1.42	ELXG350VSN332MP30S		1,800	22 × 50	0.15	1.84	ELXG800VSN182MP50S		
3,300		25.4 × 25	0.25	1.41	ELXG350VSN332MQ25S		1,800	25.4 × 40	0.15	1.82	ELXG800VSN182MQ40S		
3,900		22 × 35	0.25	1.58	ELXG350VSN392MP35S		1,800	30 × 30	0.15	1.78	ELXG800VSN182MR30S		
3,900		25.4 × 30	0.25	1.58	ELXG350VSN392MQ30S		1,800	35 × 25	0.15	1.82	ELXG800VSN182MA25S		
4,700		22 × 40	0.25	1.78	ELXG350VSN472MP40S		2,200	25.4 × 50	0.15	2.11	ELXG800VSN222MQ50S		
4,700		30 × 25	0.25	1.77	ELXG350VSN472MR25S		2,200	30 × 35	0.15	2.05	ELXG800VSN222MR35S		

Product specifications in this catalog are subject to change without notice. Request our product specifications before purchase and/or use. Please use our products based on the information contained in this catalog and product specifications.

Return Group Chart



LARGE CAPACITANCE ALUMINUM ELECTROLYTIC CAPACITORS

Long life snap-ins, 105°C

LXG Series

◆STANDARD RATINGS

WV (V _{dc})	Cap (μF)	Case size φD×L(mm)	tan δ	Rated ripple current (Arms/105°C, 120Hz)	Part No.	WV (V _{dc})	Cap (μF)	Case size φD×L(mm)	tan δ	Rated ripple current (Arms/105°C, 120Hz)	Part No.
80	2,200	35 × 30	0.15	2.09	ELXG800VSN222MA30S	100	1,000	25.4 × 35	0.15	1.41	ELXG101VSN102MQ35S
	2,700	30 × 40	0.15	2.35	ELXG800VSN272MR40S		1,000	30 × 30	0.15	1.42	ELXG101VSN102MR30S
	2,700	35 × 35	0.15	2.37	ELXG800VSN272MA35S		1,000	35 × 25	0.15	1.45	ELXG101VSN102MA25S
	3,300	30 × 50	0.15	2.75	ELXG800VSN332MR50S		1,200	22 × 50	0.15	1.60	ELXG101VSN122MP50S
	3,300	35 × 40	0.15	2.73	ELXG800VSN332MA40S		1,200	25.4 × 40	0.15	1.59	ELXG101VSN122MQ40S
	4,700	35 × 50	0.15	3.46	ELXG800VSN472MA50S		1,200	30 × 35	0.15	1.61	ELXG101VSN122MR35S
100	390	22 × 25	0.15	0.78	ELXG101VSN391MP25S		1,500	25.4 × 50	0.15	1.86	ELXG101VSN152MQ50S
	560	22 × 30	0.15	0.99	ELXG101VSN561MP30S		1,500	30 × 40	0.15	1.87	ELXG101VSN152MR40S
	560	25.4 × 25	0.15	0.98	ELXG101VSN561MQ25S		1,500	35 × 30	0.15	1.85	ELXG101VSN152MA30S
	680	22 × 35	0.15	1.12	ELXG101VSN681MP35S		1,800	35 × 35	0.15	2.07	ELXG101VSN182MA35S
	820	22 × 40	0.15	1.26	ELXG101VSN821MP40S		2,200	30 × 50	0.15	2.40	ELXG101VSN222MR50S
	820	25.4 × 30	0.15	1.23	ELXG101VSN821MQ30S		2,200	35 × 40	0.15	2.39	ELXG101VSN222MA40S
	820	30 × 25	0.15	1.25	ELXG101VSN821MR25S		2,700	35 × 50	0.15	2.81	ELXG101VSN272MA50S

◆MAXIMUM IMPEDANCE [mΩ/20°C, 30kHz]

Case size φD×L(mm)	V _{dc}		
	10 to 63	80	100
22×25	120	150	
22×30	100	120	
22×35	80	95	
22×40	70	80	
22×50	50	60	
25.4×25	90	110	
25.4×30	70	85	
25.4×35	60	70	
25.4×40	50	60	
25.4×50	40	45	
30×25	70	80	
30×30	50	60	
30×35	40	50	
30×40	35	40	
30×50	25	30	
35×25	65	70	
35×30	45	50	
35×35	38	40	
35×40	30	30	
35×50	23	25	

Return Group Chart



LARGE CAPACITANCE ALUMINUM ELECTROLYTIC CAPACITORS Overvoltage resistant design, 105°C

CHA Series

- Doesn't spark with DC over voltage
- Downsized from current KLG series
- Endurance with ripple current : 2,000 hours at 105°C
- Non solvent resistant type
- RoHS Compliant



SPECIFICATIONS

Items	Characteristics	
Category	-25 to +105°C	
Temperature Range	-25 to +105°C	
Rated Voltage Range	200 to 450V _{dc}	
Capacitance Tolerance	±20% (M) (at 20°C, 120Hz)	
Leakage Current	$I \leq 3\sqrt{CV}$ Where, I : Max. leakage current (μA), C : Nominal capacitance (μF), V : Rated voltage (V _{dc}) (at 20°C after 5 minutes)	
Dissipation Factor (tan δ)	200V _{dc} : 0.15 max. (0.20 max. for φD=35mm) 400V _{dc} : 0.15 max. (at 20°C, 120Hz)	
Low Temperature Characteristics (Max.Impedance Ratio)	Rated Voltage (V _{dc})	200 to 450V
	Z(-25°C) / Z(+20°C)	4
	(at 120Hz)	
ESL	50nH max. (at 20°C, 1MHz)	
Endurance	The following specifications shall be satisfied when the capacitors are restored to 20°C after subjected to DC voltage with the rated ripple current is applied (the peak voltage shall not exceed the rated voltage) for 2,000 hours at 105°C.	
	Capacitance change	≤ ±20% of the initial value
	D.F. (tan δ)	≤ 200% of the initial specified value
	Leakage current	≤ The initial specified value
Shelf Life	The following specifications shall be satisfied when the capacitors are restored to 20°C after exposing them for 1,000 hours at 105°C without voltage applied. Before the measurement, the capacitor shall be preconditioned by applying voltage according to Item 4.1 of JIS C 5101-4.	
	Capacitance change	≤ ±15% of the initial value
	D.F. (tan δ)	≤ 150% of the initial specified value
	Leakage current	≤ The initial specified value

DIMENSIONS [mm]

- Terminal Code : VS (φ22 to φ35)

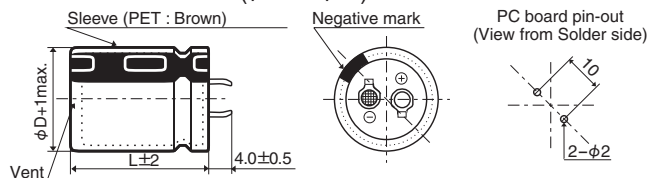

The standard design has no plastic disc.

PART NUMBERING SYSTEM

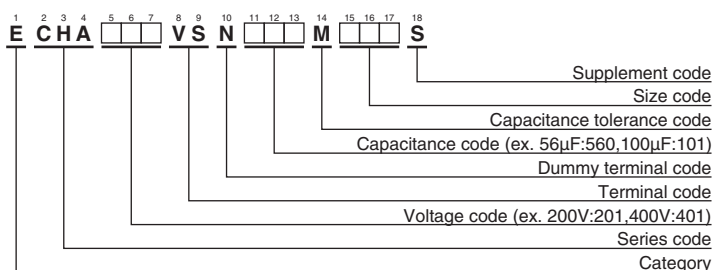

Please refer to "Product code guide (snap-in type)"

RATED RIPPLE CURRENT MULTIPLIERS

- Frequency Multipliers

Rated Voltage(V _{dc})	Frequency(Hz)					
	50	120	300	1k	10k	50k
200, 250	0.81	1.00	1.17	1.32	1.45	1.50
400, 450	0.77	1.00	1.16	1.30	1.41	1.43

The endurance of capacitors is reduced with internal heating produced by ripple current at the rate of halving the lifetime with every 5°C rise. When long life performance is required in actual use, the rms ripple current has to be reduced.

Return Group Chart



LARGE CAPACITANCE ALUMINUM ELECTROLYTIC CAPACITORS Overvoltage resistant design, 105°C

CHASeries

◆STANDARD RATINGS

WV (V _{dc})	Cap (μF)	Case size φD×L(mm)	tan δ	Rated ripple current (Arms/105°C, 120Hz)	Part No.	WV (V _{dc})	Cap (μF)	Case size φD×L(mm)	tan δ	Rated ripple current (Arms/105°C, 120Hz)	Part No.
200	180	22 × 20	0.15	0.82	ECHA201VSN181MP20S	250	820	30 × 45	0.15	2.39	ECHA251VSN821MR45S
	220	22 × 20	0.15	0.90	ECHA201VSN221MP20S		820	35 × 35	0.20	2.42	ECHA251VSN821MA35S
	270	22 × 25	0.15	1.02	ECHA201VSN271MP25S		56	22 × 20	0.15	0.45	ECHA401VSN560MP20S
	330	22 × 30	0.15	1.20	ECHA201VSN331MP30S		68	22 × 20	0.15	0.51	ECHA401VSN680MP20S
	330	25.4 × 25	0.15	1.20	ECHA201VSN331MQ25S		82	22 × 25	0.15	0.58	ECHA401VSN820MP25S
	390	22 × 30	0.15	1.35	ECHA201VSN391MP30S		100	22 × 25	0.15	0.66	ECHA401VSN101MP25S
	390	25.4 × 25	0.15	1.35	ECHA201VSN391MQ25S		100	25.4 × 25	0.15	0.66	ECHA401VSN101MQ25S
	470	22 × 35	0.15	1.45	ECHA201VSN471MP35S		120	22 × 30	0.15	0.76	ECHA401VSN121MP30S
	470	25.4 × 30	0.15	1.45	ECHA201VSN471MQ30S		120	25.4 × 25	0.15	0.76	ECHA401VSN121MQ25S
	470	30 × 25	0.15	1.47	ECHA201VSN471MR25S		150	22 × 35	0.15	0.85	ECHA401VSN151MP35S
	560	22 × 40	0.15	1.62	ECHA201VSN561MP40S		150	25.4 × 30	0.15	0.85	ECHA401VSN151MQ30S
	560	25.4 × 30	0.15	1.60	ECHA201VSN561MQ30S		150	30 × 25	0.15	0.85	ECHA401VSN151MR25S
	560	30 × 25	0.15	1.60	ECHA201VSN561MR25S		180	22 × 40	0.15	0.94	ECHA401VSN181MP40S
	680	25.4 × 35	0.15	1.82	ECHA201VSN681MQ35S		180	25.4 × 35	0.15	0.95	ECHA401VSN181MQ35S
	680	30 × 30	0.15	1.81	ECHA201VSN681MR30S		180	30 × 25	0.15	0.95	ECHA401VSN181MR25S
	680	35 × 25	0.20	1.86	ECHA201VSN681MA25S		220	25.4 × 35	0.15	1.24	ECHA401VSN221MQ35S
	820	25.4 × 45	0.15	2.11	ECHA201VSN821MQ45S		220	30 × 30	0.15	1.24	ECHA401VSN221MR30S
	820	30 × 35	0.15	2.11	ECHA201VSN821MR35S		220	35 × 25	0.15	1.24	ECHA401VSN221MA25S
	820	35 × 25	0.20	2.11	ECHA201VSN821MA25S		270	25.4 × 45	0.15	1.30	ECHA401VSN271MQ45S
	1,000	30 × 35	0.15	2.40	ECHA201VSN102MR35S		270	30 × 35	0.15	1.30	ECHA401VSN271MR35S
1,000	35 × 30	0.20	2.40	ECHA201VSN102MA30S	270	35 × 25	0.15	1.30	ECHA401VSN271MA25S		
1,200	30 × 45	0.15	2.69	ECHA201VSN122MR45S	330	30 × 35	0.15	1.45	ECHA401VSN331MR35S		
1,200	35 × 35	0.20	2.65	ECHA201VSN122MA35S	330	30 × 40	0.15	1.47	ECHA401VSN331MR40S		
250	120	22 × 20	0.15	0.68	ECHA251VSN121MP20S	330	35 × 30	0.15	1.47	ECHA401VSN331MA30S	
	180	22 × 25	0.15	0.87	ECHA251VSN181MP25S	390	30 × 40	0.15	1.60	ECHA401VSN391MR40S	
	180	25.4 × 20	0.15	0.93	ECHA251VSN181MQ20S	390	35 × 35	0.15	1.61	ECHA401VSN391MA35S	
	220	22 × 30	0.15	1.00	ECHA251VSN221MP30S	470	35 × 40	0.15	1.84	ECHA401VSN471MA40S	
	270	22 × 35	0.15	1.14	ECHA251VSN271MP35S	450	82	25.4 × 25	0.20	0.61	ECHA451VSN820MQ25S
	270	25.4 × 25	0.15	1.13	ECHA251VSN271MQ25S		120	25.4 × 30	0.20	0.76	ECHA451VSN121MQ30S
	270	30 × 20	0.15	1.25	ECHA251VSN271MR20S		120	30 × 25	0.20	0.77	ECHA451VSN121MR25S
	330	22 × 40	0.15	1.28	ECHA251VSN331MP40S		150	25.4 × 35	0.20	0.88	ECHA451VSN151MQ35S
	330	25.4 × 30	0.15	1.29	ECHA251VSN331MQ30S		180	25.4 × 40	0.20	0.99	ECHA451VSN181MQ40S
	390	22 × 45	0.15	1.42	ECHA251VSN391MP45S		180	30 × 30	0.20	0.97	ECHA451VSN181MR30S
	390	25.4 × 35	0.15	1.46	ECHA251VSN391MQ35S		180	30 × 35	0.20	1.00	ECHA451VSN181MR35S
	390	30 × 25	0.15	1.52	ECHA251VSN391MR25S		220	30 × 35	0.20	1.30	ECHA451VSN221MR35S
	390	35 × 20	0.20	1.62	ECHA251VSN391MA20S		220	35 × 25	0.20	1.20	ECHA451VSN221MA25S
	470	25.4 × 40	0.15	1.64	ECHA251VSN471MQ40S		270	30 × 35	0.20	1.22	ECHA451VSN271MR35S
	470	30 × 30	0.15	1.67	ECHA251VSN471MR30S		270	30 × 40	0.20	1.28	ECHA451VSN271MR40S
	560	25.4 × 45	0.15	1.82	ECHA251VSN561MQ45S		270	35 × 30	0.20	1.30	ECHA451VSN271MA30S
	560	30 × 35	0.15	1.87	ECHA251VSN561MR35S		330	35 × 35	0.20	1.40	ECHA451VSN331MA35S
	560	35 × 25	0.20	1.99	ECHA251VSN561MA25S		390	35 × 40	0.20	1.60	ECHA451VSN391MA40S
	680	30 × 40	0.15	2.12	ECHA251VSN681MR40S		420	35 × 50	0.20	1.56	ECHA451VSN421MA50S
	680	35 × 30	0.20	2.19	ECHA251VSN681MA30S						

◆DC OVERVOLTAGE TEST CONDITIONS

The vent will operate and the capacitor shall become an open circuit without burning materials when the following test DC voltage is applied.

●Test DC voltage

Rated Voltage	Nominal Capacitance	Current Limit	Test Voltage
200V _{dc}	<330μF	4A	300/375V _{dc}
	330μF ≤ C < 470μF	5A	
	≥ 470μF	7A	
250V _{dc}	<330μF	4A	350/450V _{dc}
	330μF ≤ C < 470μF	5A	
	≥ 470μF	7A	
400V _{dc}	<100μF	2A	500/600V _{dc}
	100μF ≤ C < 220μF	4A	
	≥ 220μF	7A	
450V _{dc}	<100μF	2A	550/675V _{dc}
	100μF ≤ C < 220μF	4A	
	≥ 220μF	7A	

●Test Circuit

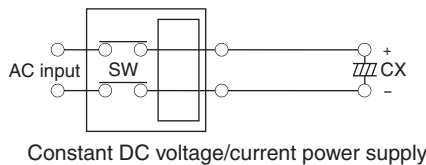

Return Group Chart



LARGE CAPACITANCE ALUMINUM ELECTROLYTIC CAPACITORS

Snap-ins, 105°C

KMV Series



- For frequently change of regenerative voltage from AC servo amplifier and inverter control
- Ideal use to power supply, specially power source with turn on and off frequently and highly voltage fluctuation
- Improved the resistance for charge and discharge from same dimension of KMQ series
- Endurance with ripple current : 3,000 hours at 105°C
- Rated voltage range : 350 to 450V_{dc}, Capacitance 82 to 1,200μF
- Non solvent resistant type
- RoHS Compliant

◆ SPECIFICATIONS

Items	Characteristics		
Category	-25 to +105°C		
Temperature Range	-25 to +105°C		
Rated Voltage Range	350 to 450V _{dc}		
Capacitance Tolerance	±20% (M) (at 20°C, 120Hz)		
Leakage Current	$I \leq 3\sqrt{CV}$ Where, I : Max. leakage current (μA), C : Nominal capacitance (μF), V : Rated voltage (V) (at 20°C after 5 minutes)		
Dissipation Factor (tan δ)	Rated voltage (V _{dc})	350 & 400V	420 & 450V
	tan δ (Max.)	0.15	0.20
Low Temperature Characteristics (Max. Impedance Ratio)	Rated voltage (V _{dc})	350 to 450V	
	Z(-25°C)/Z(+20°C)	8	
Charge and Discharge	The following specifications shall be satisfied when the capacitors are restored to 20°C after subjected to charge and discharge test with the voltage waveform shown below at room temperature (15 to 35°C).		
	Capacitance change	≤ ±20% of the initial value	
	D.F. (tan δ)	≤200% of the initial specified value	
	Leakage current	≤The initial specified value	
	Frequency	6Hz	
	Number of cycles	50 million times	
	Voltage waveform		
Endurance	The following specifications shall be satisfied when the capacitors are restored to 20°C after subjected to DC voltage with the rated ripple current is applied (the peak voltage shall not exceed the rated voltage) for 3,000 hours at 105°C.		
	Capacitance change	≤ ±20% of the initial value	
	D.F. (tan δ)	≤200% of the initial specified value	
	Leakage current	≤The initial specified value	
Shelf Life	The following specifications shall be satisfied when the capacitors are restored to 20°C after exposing them for 1,000 hours at 105°C without voltage applied. Before the measurement, the capacitor shall be preconditioned by applying voltage according to Item 4.1 of JIS C 5101-4.		
	Capacitance change	≤ ±15% of the initial value	
	D.F. (tan δ)	≤150% of the initial specified value	
	Leakage current	≤The initial specified value	

*Please consult with us about charge and discharge conditions.

◆ DIMENSIONS [mm]

● Terminal Code : VS (φ22 to φ35) : Standard

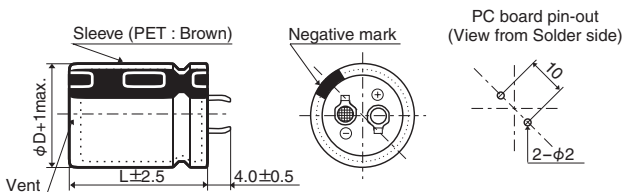

● Terminal Code : LI (φ35)

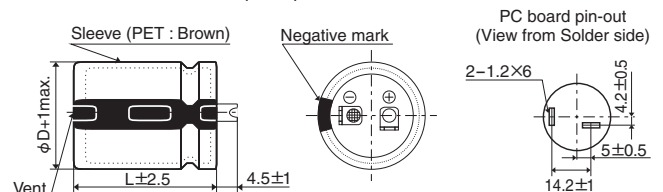

No plastic disk is the standard design.

Return Group Chart



LARGE CAPACITANCE ALUMINUM ELECTROLYTIC CAPACITORS

Snap-ins, 105°C

KMV Series

◆PART NUMBERING SYSTEM

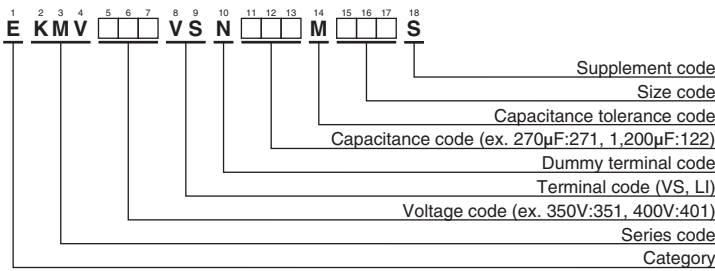

Please refer to "Product code guide (snap-in type)"

◆STANDARD RATINGS

WV (V _{dc})	Cap (μF)	Case size φD×L(mm)	Rated ripple current (Arms/105°C, 120Hz)	Max. charge current and Max. discharge current (Arms/6Hz)	Part No.	WV (V _{dc})	Cap (μF)	Case size φD×L(mm)	Rated ripple current (Arms/105°C, 120Hz)	Max. charge current and Max. discharge current (Arms/6Hz)	Part No.
350	120	22 × 25	0.74	0.42	EKMV351VSN121MP25S	420	82	22 × 25	0.64	0.34	EKMV421VSN820MP25S
	150	22 × 30	0.87	0.49	EKMV351VSN151MP30S		120	22 × 30	0.81	0.44	EKMV421VSN121MP30S
	180	25.4 × 25	0.92	0.54	EKMV351VSN181MQ25S		120	25.4 × 25	0.81	0.44	EKMV421VSN121MQ25S
	220	22 × 35	1.08	0.60	EKMV351VSN221MP35S		150	22 × 35	0.93	0.50	EKMV421VSN151MP35S
	220	22 × 40	1.10	0.62	EKMV351VSN221MP40S		150	25.4 × 30	0.93	0.50	EKMV421VSN151MQ30S
	220	25.4 × 30	1.05	0.61	EKMV351VSN221MQ30S		180	22 × 40	1.04	0.56	EKMV421VSN181MP40S
	270	22 × 45	1.24	0.71	EKMV351VSN271MP45S		180	22 × 45	1.06	0.58	EKMV421VSN181MP45S
	270	25.4 × 35	1.21	0.70	EKMV351VSN271MQ35S		180	25.4 × 35	1.06	0.58	EKMV421VSN181MQ35S
	270	30 × 25	1.15	0.68	EKMV351VSN271MR25S		180	30 × 25	1.02	0.56	EKMV421VSN181MR25S
	330	22 × 50	1.41	0.80	EKMV351VSN331MP50S		220	22 × 50	1.20	0.66	EKMV421VSN221MP50S
	330	25.4 × 40	1.37	0.80	EKMV351VSN331MQ40S		220	25.4 × 40	1.20	0.65	EKMV421VSN221MQ40S
	330	30 × 30	1.29	0.77	EKMV351VSN331MR30S		220	30 × 30	1.14	0.63	EKMV421VSN221MR30S
	330	35 × 25	1.31	0.78	EKMV351VSN331MA25S		270	25.4 × 45	1.36	0.74	EKMV421VSN271MQ45S
	390	25.4 × 45	1.51	0.89	EKMV351VSN391MQ45S		270	30 × 35	1.29	0.73	EKMV421VSN271MR35S
	390	30 × 35	1.44	0.88	EKMV351VSN391MR35S		270	35 × 25	1.26	0.71	EKMV421VSN271MA25S
	470	25.4 × 50	1.69	0.99	EKMV351VSN471MQ50S		330	25.4 × 50	1.52	0.83	EKMV421VSN331MQ50S
	470	30 × 40	1.62	1.00	EKMV351VSN471MR40S		330	30 × 40	1.47	0.84	EKMV421VSN331MR40S
	470	35 × 30	1.61	0.97	EKMV351VSN471MA30S		330	35 × 30	1.42	0.82	EKMV421VSN331MA30S
	560	30 × 45	1.82	1.12	EKMV351VSN561MR45S		390	30 × 45	1.64	0.94	EKMV421VSN391MR45S
	560	35 × 35	1.77	1.08	EKMV351VSN561MA35S		390	35 × 35	1.56	0.91	EKMV421VSN391MA35S
680	30 × 50	2.04	1.27	EKMV351VSN681MR50S	470	30 × 50	1.83	1.06	EKMV421VSN471MR50S		
680	35 × 40	2.02	1.25	EKMV351VSN681MA40S	470	35 × 40	1.78	1.05	EKMV421VSN471MA40S		
820	35 × 45	2.27	1.41	EKMV351VSN821MA45S	560	35 × 45	1.98	1.18	EKMV421VSN561MA45S		
820	35 × 50	2.32	1.46	EKMV351VSN821MA50S	680	35 × 50	2.23	1.34	EKMV421VSN681MA50S		
1,200	35 × 60	2.88	1.84	EKMV351VSN122MA60S	820	35 × 60	2.52	1.55	EKMV421VSN821MA60S		
400	100	22 × 25	0.69	0.38	EKMV401VSN101MP25S	450	82	22 × 25	0.64	0.34	EKMV451VSN820MP25S
	120	22 × 30	0.79	0.44	EKMV401VSN121MP30S		100	22 × 30	0.72	0.40	EKMV451VSN101MP30S
	150	25.4 × 25	0.87	0.49	EKMV401VSN151MQ25S		100	25.4 × 25	0.72	0.40	EKMV451VSN101MQ25S
	180	22 × 35	0.99	0.55	EKMV401VSN181MP35S		120	22 × 35	0.81	0.45	EKMV451VSN121MP35S
	180	22 × 40	1.01	0.56	EKMV401VSN181MP40S		150	22 × 40	0.93	0.51	EKMV451VSN151MP40S
	180	25.4 × 30	0.98	0.55	EKMV401VSN181MQ30S		150	25.4 × 30	0.91	0.50	EKMV451VSN151MQ30S
	220	22 × 45	1.14	0.64	EKMV401VSN221MP45S		150	30 × 25	0.90	0.51	EKMV451VSN151MR25S
	220	25.4 × 35	1.13	0.63	EKMV401VSN221MQ35S		180	22 × 45	1.03	0.58	EKMV451VSN181MP45S
	220	30 × 25	1.10	0.61	EKMV401VSN221MR25S		180	22 × 50	1.06	0.59	EKMV451VSN181MP50S
	270	22 × 50	1.30	0.73	EKMV401VSN271MP50S		180	25.4 × 35	1.04	0.57	EKMV451VSN181MQ35S
	270	25.4 × 40	1.28	0.72	EKMV401VSN271MQ40S		220	25.4 × 40	1.18	0.65	EKMV451VSN221MQ40S
	270	30 × 30	1.22	0.70	EKMV401VSN271MR30S		220	25.4 × 45	1.20	0.67	EKMV451VSN221MQ45S
	270	35 × 25	1.26	0.71	EKMV401VSN271MA25S		220	30 × 30	1.10	0.63	EKMV451VSN221MR30S
	330	25.4 × 45	1.44	0.82	EKMV401VSN331MQ45S		220	35 × 25	1.12	0.64	EKMV451VSN221MA25S
	330	30 × 35	1.38	0.81	EKMV401VSN331MR35S		270	25.4 × 50	1.35	0.75	EKMV451VSN271MQ50S
	390	25.4 × 50	1.59	0.91	EKMV401VSN391MQ50S		270	30 × 35	1.25	0.73	EKMV451VSN271MR35S
	390	30 × 40	1.55	0.91	EKMV401VSN391MR40S		270	35 × 30	1.27	0.74	EKMV451VSN271MA30S
	390	35 × 30	1.55	0.89	EKMV401VSN391MA30S		330	30 × 40	1.42	0.84	EKMV451VSN331MR40S
	470	30 × 45	1.74	1.03	EKMV401VSN471MR45S		330	30 × 45	1.46	0.87	EKMV451VSN331MR45S
	470	35 × 35	1.71	1.00	EKMV401VSN471MA35S		330	35 × 35	1.41	0.84	EKMV451VSN331MA35S
560	30 × 50	1.93	1.15	EKMV401VSN561MR50S	390	30 × 50	1.61	0.97	EKMV451VSN391MR50S		
560	35 × 40	1.94	1.14	EKMV401VSN561MA40S	390	35 × 40	1.59	0.96	EKMV451VSN391MA40S		
680	35 × 45	2.19	1.29	EKMV401VSN681MA45S	470	35 × 45	1.79	1.08	EKMV451VSN471MA45S		
820	35 × 50	2.45	1.44	EKMV401VSN821MA50S	560	35 × 50	2.00	1.22	EKMV451VSN561MA50S		
1,000	35 × 60	2.79	1.70	EKMV401VSN102MA60S	680	35 × 60	2.26	1.42	EKMV451VSN681MA60S		



KMV Series

◆ RATED RIPPLE CURRENT MULTIPLIERS

● Frequency Multipliers

Frequency(Hz)	50	120	300	1k	10k	50k
Coefficient	0.77	1.00	1.16	1.30	1.41	1.43

The endurance of capacitors is shorted with internal heating produced by ripple current at the rate of halving the lifetime with every 5°C rise. When long life performance is required in actual use, the rms ripple current has to be reduced.

Return Group Chart



PART NUMBERING SYSTEM

Product code guide (Screw mount terminal type)

(Example : KMH series, 400V-3,300 μ F, ϕ 63.5 \times 120L, Without mounting clamp)



Please refer to the following table

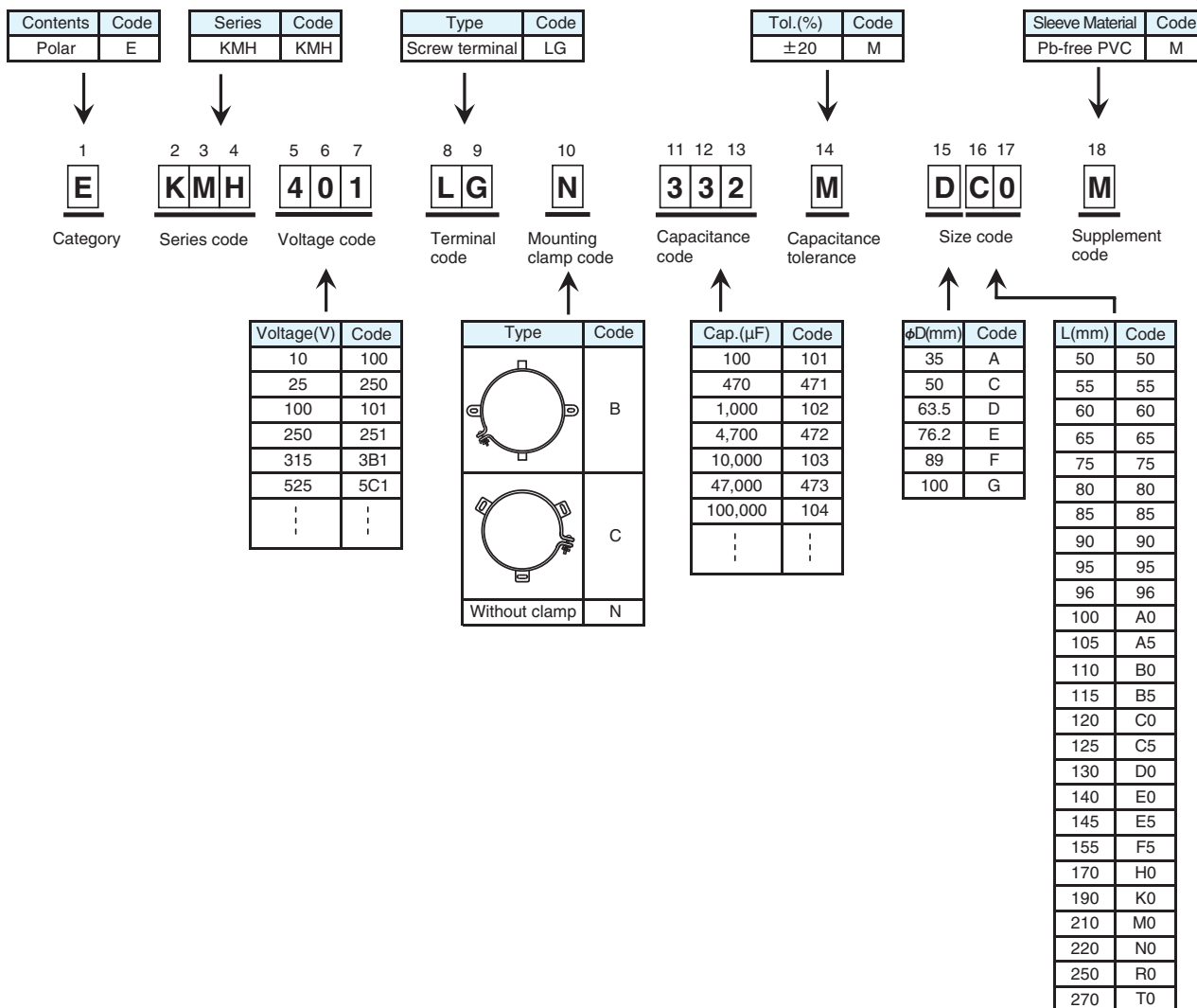

*Refer to the appendix (Part number) for codes not listed here.

Return Group Chart



LARGE CAPACITANCE ALUMINUM ELECTROLYTIC CAPACITORS

Standard screw terminals, 85°C

SME Series

- Endurance with ripple current : 2,000 hours at 85°C
- RoHS Compliant



◆ SPECIFICATIONS

Items	Characteristics						
Category	-40 to +85°C (10 to 100V _{dc})						
Temperature Range	-40 to +85°C (10 to 100V _{dc})						
Rated Voltage Range	10 to 100V _{dc}						
Capacitance Tolerance	±20% (M) (at 20°C, 120Hz)						
Leakage Current	I=0.02CV or 5mA, whichever is smaller. Where, I : Max. leakage current (μA), C : Nominal capacitance (μF), V : Rated voltage (V) (at 20°C after 5 minutes)						
Dissipation Factor (tan δ)	Shall not exceed the values shown in the STANDARD RATINGS (at 20°C, 120Hz)						
Low Temperature Characteristics	Capacitance change $C(-25^{\circ}\text{C})/C(+20^{\circ}\text{C}) \geq 0.7$ (at 120Hz)						
Insulation Resistance	When measured between the terminals that are connected to each other and to the mounting clamp on the insulating sleeve covering the case by using an insulation resistance meter of 500V _{dc} , the insulation resistance shall not be less than 100MΩ.						
Insulation Withstanding Voltage	When a voltage of 2,000V _{ac} is applied for 1 minute between the terminals that are connected to each other and to the mounting clamp on the insulating sleeve covering the case, there shall not be electrical damage.						
Endurance	The following specifications shall be satisfied when the capacitors are restored to 20°C after subjected to DC voltage with the rated ripple current is applied (the peak voltage shall not exceed the rated voltage) for 2,000 hours at 85°C. <table border="1"> <tr> <td>Capacitance change</td> <td>≤ ±20% of the initial value</td> </tr> <tr> <td>D.F. (tan δ)</td> <td>≤ 200% of the initial specified value</td> </tr> <tr> <td>Leakage current</td> <td>≤ The initial specified value</td> </tr> </table>	Capacitance change	≤ ±20% of the initial value	D.F. (tan δ)	≤ 200% of the initial specified value	Leakage current	≤ The initial specified value
Capacitance change	≤ ±20% of the initial value						
D.F. (tan δ)	≤ 200% of the initial specified value						
Leakage current	≤ The initial specified value						
Shelf Life	The following specifications shall be satisfied when the capacitors are restored to 20°C after exposing them for 500 hours at 85°C without voltage applied. Before the measurement, the capacitor shall be preconditioned by applying voltage according to Item 4.1 of JIS C 5101-4. <table border="1"> <tr> <td>Capacitance change</td> <td>≤ ±20% of the initial value</td> </tr> <tr> <td>D.F. (tan δ)</td> <td>≤ 150% of the initial specified value</td> </tr> <tr> <td>Leakage current</td> <td>≤ The initial specified value</td> </tr> </table>	Capacitance change	≤ ±20% of the initial value	D.F. (tan δ)	≤ 150% of the initial specified value	Leakage current	≤ The initial specified value
Capacitance change	≤ ±20% of the initial value						
D.F. (tan δ)	≤ 150% of the initial specified value						
Leakage current	≤ The initial specified value						

◆ DIMENSIONS (Screw-Mount) [mm]

● Terminal Code : LG

● Mounting Clamp Code : B

● Mounting Clamp Code : C

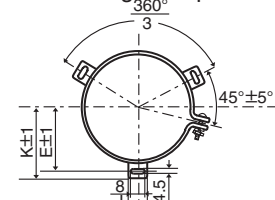
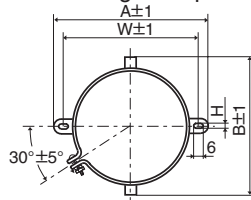
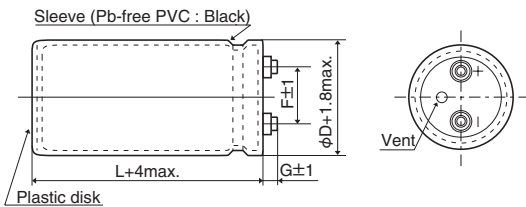

φD	A	B	W	H	F
35	58.0	44.0	48.0	3.5	12.7
50	78.0	64.0	68.0	4.5	22.4
63.5	90.0	76.0	80.0	4.5	28.0
76.2	104.5	90.0	93.5	4.5	31.5

φD	E	K	J	F
50	32.5	37.0	14.0	22.4
63.5	38.1	43.5	14.0	28.0
76.2	44.5	50.0	14.0	31.5
89	50.8	56.5	16.0	31.5

φ35 to φ63.5 : G=6
φ76.2 & φ89 : G=5

<Screw specifications>

Plus hexagon-headed screw : M5×0.8×10

Maximum screw tightening torque : 3.23Nm

* The screw and the mounting clamp are separately supplied and not attached to the product.

◆ PART NUMBERING SYSTEM

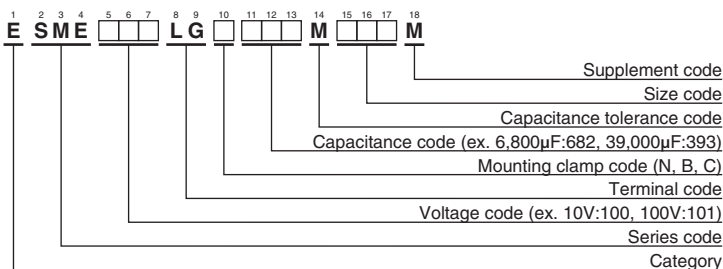

Please refer to "Product code guide (screw-mount terminal type)"

Return Group Chart



LARGE CAPACITANCE ALUMINUM ELECTROLYTIC CAPACITORS

Standard screw terminals, 85°C

SME Series

◆ STANDARD RATINGS

WV (V _{dc})	Cap (μF)	Case size φD×L(mm)	tan δ	Rated ripple current (Arms/85°C, 120Hz)	Part No.	WV (V _{dc})	Cap (μF)	Case size φD×L(mm)	tan δ	Rated ripple current (Arms/85°C, 120Hz)	Part No.
10	39,000	35 × 50	0.60	4.70	ESME100LGB393MA50M	50	10,000	35 × 50	0.25	4.10	ESME500LGB103MA50M
	82,000	35 × 80	0.60	7.40	ESME100LGB823MA80M		18,000	35 × 80	0.25	5.20	ESME500LGB183MA80M
	100,000	35 × 100	0.70	8.00	ESME100LGB104MAA0M		22,000	35 × 100	0.30	5.90	ESME500LGB223MAA0M
	120,000	35 × 120	0.70	9.40	ESME100LGB124MAC0M		27,000	35 × 120	0.35	6.60	ESME500LGB273MAC0M
	150,000	50 × 80	0.90	9.80	ESME100LGC154MC80M		39,000	50 × 80	0.40	7.40	ESME500LGC393MC80M
	220,000	50 × 100	1.00	12.1	ESME100LGC224MCA0M		56,000	50 × 100	0.40	9.80	ESME500LGC563MCA0M
	270,000	50 × 120	1.20	13.6	ESME100LGC274MCC0M		68,000	50 × 120	0.45	11.1	ESME500LGC683MCC0M
	390,000	63.5 × 100	1.50	15.3	ESME100LGC394MDA0M		82,000	63.5 × 100	0.50	12.2	ESME500LGC823MDA0M
	470,000	63.5 × 120	2.00	16.0	ESME100LGC474MDC0M		120,000	63.5 × 120	0.50	16.0	ESME500LGC124MDC0M
	560,000	76.2 × 100	2.50	17.3	ESME100LGC564MEA0M		150,000	76.2 × 120	0.60	18.1	ESME500LGC154MEC0M
680,000	76.2 × 120	3.00	18.7	ESME100LGC684MEC0M	180,000	76.2 × 140	0.70	19.5	ESME500LGC184MEE0M		
16	27,000	35 × 50	0.45	4.20	ESME160LGB273MA50M	270,000	89 × 140	0.80	24.6	ESME500LGC274MFE0M	
	56,000	35 × 80	0.60	6.50	ESME160LGB563MA80M	63	5,600	35 × 50	0.20	3.00	ESME630LGB562MA50M
	82,000	35 × 100	0.70	8.00	ESME160LGB823MAA0M		10,000	35 × 80	0.25	4.00	ESME630LGB103MA80M
	100,000	35 × 120	0.70	9.60	ESME160LGB104MAC0M		15,000	35 × 100	0.25	5.30	ESME630LGB153MAA0M
	120,000	50 × 80	0.80	9.60	ESME160LGC124MC80M		18,000	35 × 120	0.25	6.20	ESME630LGB183MAC0M
	150,000	50 × 100	0.90	11.2	ESME160LGC154MCA0M		22,000	50 × 80	0.30	6.50	ESME630LGC223MC80M
	220,000	50 × 120	1.00	14.2	ESME160LGC224MCC0M		33,000	50 × 100	0.35	8.10	ESME630LGC333MCA0M
	270,000	63.5 × 100	1.20	15.3	ESME160LGC274MDA0M		39,000	50 × 120	0.35	9.60	ESME630LGC393MCC0M
	330,000	63.5 × 120	1.30	17.1	ESME160LGC334MDC0M		47,000	63.5 × 100	0.40	10.2	ESME630LGC473MDA0M
	390,000	76.2 × 100	1.60	18.0	ESME160LGC394MEA0M		68,000	63.5 × 120	0.40	13.3	ESME630LGC683MDC0M
470,000	76.2 × 120	1.80	19.3	ESME160LGC474MEC0M	100,000		76.2 × 120	0.45	17.1	ESME630LGC104MEC0M	
560,000	76.2 × 140	2.00	20.7	ESME160LGC564MEE0M	120,000	76.2 × 140	0.50	19.0	ESME630LGC124MEE0M		
25	18,000	35 × 50	0.35	4.00	ESME250LGB183MA50M	150,000	89 × 140	0.55	22.0	ESME630LGC154MFE0M	
	39,000	35 × 80	0.40	6.20	ESME250LGB393MA80M	80	3,300	35 × 50	0.15	2.50	ESME800LGB332MA50M
	47,000	35 × 100	0.40	7.40	ESME250LGB473MAA0M		6,800	35 × 80	0.20	3.70	ESME800LGB682MA80M
	56,000	35 × 120	0.45	8.30	ESME250LGB563MAC0M		10,000	35 × 100	0.20	4.90	ESME800LGB103MAA0M
	82,000	50 × 80	0.50	9.70	ESME250LGC823MC80M		12,000	35 × 120	0.20	5.40	ESME800LGB123MAC0M
	100,000	50 × 100	0.60	10.8	ESME250LGC104MCA0M		15,000	50 × 80	0.25	6.00	ESME800LGC153MC80M
	120,000	50 × 120	0.60	12.8	ESME250LGC124MCC0M		22,000	50 × 100	0.30	7.10	ESME800LGC223MCA0M
	180,000	63.5 × 100	0.75	14.7	ESME250LGC184MDA0M		27,000	50 × 120	0.30	8.60	ESME800LGC273MCC0M
	220,000	63.5 × 120	0.80	16.8	ESME250LGC224MDC0M		33,000	63.5 × 100	0.35	9.30	ESME800LGC333MDA0M
	270,000	76.2 × 100	0.90	18.3	ESME250LGC274MEA0M		47,000	63.5 × 120	0.35	12.0	ESME800LGC473MDC0M
330,000	76.2 × 120	1.00	20.7	ESME250LGC334MEC0M	68,000		76.2 × 120	0.35	15.4	ESME800LGC683MEC0M	
390,000	76.2 × 140	1.20	22.1	ESME250LGC394MEE0M	82,000	76.2 × 140	0.35	18.1	ESME800LGC823MEE0M		
560,000	89 × 140	1.50	25.8	ESME250LGC564MFE0M	100,000	89 × 140	0.40	21.0	ESME800LGC104MFE0M		
35	15,000	35 × 50	0.30	3.90	ESME350LGB153MA50M	100	2,200	35 × 50	0.10	2.50	ESME101LGB222MA50M
	33,000	35 × 80	0.40	6.00	ESME350LGB333MA80M		4,700	35 × 80	0.15	3.40	ESME101LGB472MA80M
	39,000	35 × 100	0.40	7.00	ESME350LGB393MAA0M		6,800	35 × 100	0.15	4.20	ESME101LGB682MAA0M
	47,000	35 × 120	0.45	8.00	ESME350LGB473MAC0M		8,200	35 × 120	0.15	5.00	ESME101LGB822MAC0M
	68,000	50 × 80	0.50	9.00	ESME350LGC683MC80M		10,000	50 × 80	0.20	5.20	ESME101LGC103MC80M
	82,000	50 × 100	0.55	10.3	ESME350LGC823MCA0M		18,000	50 × 120	0.20	8.10	ESME101LGC183MCC0M
	120,000	50 × 120	0.60	12.8	ESME350LGC124MCC0M		22,000	63.5 × 100	0.25	8.60	ESME101LGC223MDA0M
	150,000	63.5 × 100	0.70	14.0	ESME350LGC154MDA0M		27,000	63.5 × 120	0.25	10.3	ESME101LGC273MDC0M
	180,000	63.5 × 120	0.70	16.6	ESME350LGC184MDC0M		33,000	76.2 × 100	0.25	11.1	ESME101LGC333MEA0M
	220,000	76.2 × 100	0.75	17.3	ESME350LGC224MEA0M		39,000	76.2 × 120	0.25	12.4	ESME101LGC393MEC0M
270,000	76.2 × 120	0.80	19.8	ESME350LGC274MEC0M	47,000	76.2 × 140	0.25	14.3	ESME101LGC473MEE0M		
330,000	76.2 × 140	0.90	22.5	ESME350LGC334MEE0M	68,000	89 × 140	0.30	18.0	ESME101LGC683MFE0M		
470,000	89 × 140	1.00	28.3	ESME350LGC474MFE0M							

◆ RATED RIPPLE CURRENT MULTIPLIERS

● Frequency Multipliers

Rated voltage (V _{dc})	Case diameter (mm)	Frequency (Hz)					
		50	120	300	1k	10k	50k
10 to 50	φ35 to φ89	0.95	1.00	1.03	1.05	1.09	1.12
63 & 80	φ35	0.90	1.00	1.06	1.10	1.18	1.22
	φ50 to φ89	0.95	1.00	1.03	1.05	1.09	1.12
100	φ35	0.82	1.00	1.12	1.22	1.30	1.33
	φ50	0.90	1.00	1.06	1.10	1.18	1.22
	φ63.5 to φ89	0.95	1.00	1.03	1.05	1.09	1.12

The endurance of capacitors is reduced with internal heating produced by ripple current at the rate of halving the lifetime with every 5°C rise. When long life performance is required in actual use, the rms ripple current has to be reduced.

Return Group Chart



LARGE CAPACITANCE ALUMINUM ELECTROLYTIC CAPACITORS Standard screw terminals, 105°C

KMQ Series

- Endurance with ripple current : 2,000 hours at 105°C
- Downsized and high ripple current from KMH series
- RoHS Compliant

KMQ

↑
Downsized
Higher ripple
KMH P294



◆ SPECIFICATIONS

Items	Characteristics						
Category	-25 to +105°C						
Temperature Range							
Rated Voltage Range	315 to 450V _{dc}						
Capacitance Tolerance	±20% (M) (at 20°C, 120Hz)						
Leakage Current	I=0.02CV or 5mA, whichever is smaller. Where, I : Max. leakage current (μA), C : Nominal capacitance (μF), V : Rated voltage (V) (at 20°C after 5 minutes)						
Dissipation Factor (tan δ)	Shall not exceed the values shown in the STANDARD RATINGS (at 20°C, 120Hz)						
Low Temperature Characteristics	Capacitance change $C(-25^{\circ}\text{C})/C(+20^{\circ}\text{C}) \geq 0.7$ (at 120Hz)						
Insulation Resistance	When measured between the terminals that are connected to each other and to the mounting clamp on the insulating sleeve covering the case by using an insulation resistance meter of 500V _{dc} , the insulation resistance shall not be less than 100MΩ.						
Insulation Withstanding Voltage	When a voltage of 2,000V _{ac} is applied for 1 minute between the terminals that are connected to each other and to the mounting clamp on the insulating sleeve covering the case, there shall not be electrical damage.						
Endurance	The following specifications shall be satisfied when the capacitors are restored to 20°C after subjected to DC voltage with the rated ripple current is applied (the peak voltage shall not exceed the rated voltage) for 2,000 hours at 105°C. <table border="1"> <tr> <td>Capacitance change</td> <td>≤ ±20% of the initial value</td> </tr> <tr> <td>D.F. (tan δ)</td> <td>≤ 200% of the initial specified value</td> </tr> <tr> <td>Leakage current</td> <td>≤ The initial specified value</td> </tr> </table>	Capacitance change	≤ ±20% of the initial value	D.F. (tan δ)	≤ 200% of the initial specified value	Leakage current	≤ The initial specified value
Capacitance change	≤ ±20% of the initial value						
D.F. (tan δ)	≤ 200% of the initial specified value						
Leakage current	≤ The initial specified value						
Shelf Life	The following specifications shall be satisfied when the capacitors are restored to 20°C after exposing them for 500 hours at 105°C without voltage applied. Before the measurement, the capacitor shall be preconditioned by applying voltage according to Item 4.1 of JIS C 5101-4. <table border="1"> <tr> <td>Capacitance change</td> <td>≤ ±20% of the initial value</td> </tr> <tr> <td>D.F. (tan δ)</td> <td>≤ 200% of the initial specified value</td> </tr> <tr> <td>Leakage current</td> <td>≤ The initial specified value</td> </tr> </table>	Capacitance change	≤ ±20% of the initial value	D.F. (tan δ)	≤ 200% of the initial specified value	Leakage current	≤ The initial specified value
Capacitance change	≤ ±20% of the initial value						
D.F. (tan δ)	≤ 200% of the initial specified value						
Leakage current	≤ The initial specified value						

◆ DIMENSIONS (Screw-Mount) [mm]

● Terminal Code : LG

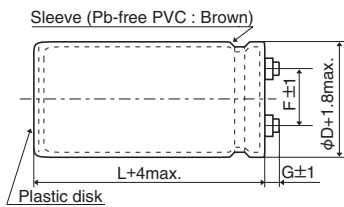

φ35 to φ63.5 : G=6
φ76.2 & φ89 : G=5

<Screw specifications>

Plus hexagon-headed screw : M5×0.8×10

Maximum screw tightening torque : 3.23Nm

* The screw and the mounting clamp are separately supplied and not attached to the product.

● Mounting Clamp Code : B

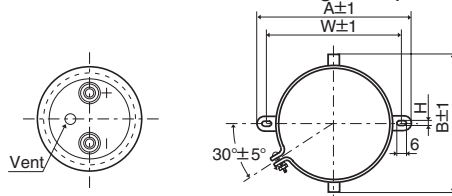

φD	A	B	W	H	F
35	58.0	44.0	48.0	3.5	12.7
50	78.0	64.0	68.0	4.5	22.4
63.5	90.0	76.0	80.0	4.5	28.0
76.2	104.5	90.0	93.5	4.5	31.5

● Mounting Clamp Code : C

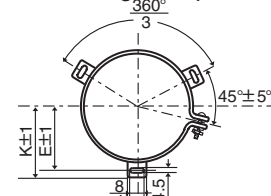

φD	E	K	J	F
50	32.5	37.0	14.0	22.4
63.5	38.1	43.5	14.0	28.0
76.2	44.5	50.0	14.0	31.5
89	50.8	56.5	16.0	31.5

◆ PART NUMBERING SYSTEM

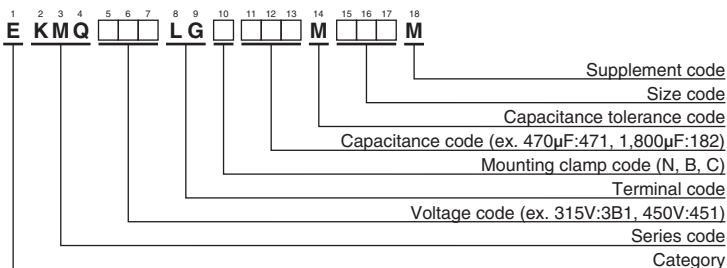

Please refer to "Product code guide (screw-mount terminal type)"

Return Group Chart



LARGE CAPACITANCE ALUMINUM ELECTROLYTIC CAPACITORS Standard screw terminals, 105°C

KMQSeries

◆STANDARD RATINGS

WV (V _{dc})	Cap (μF)	Case size φD×L(mm)	tan δ	Rated ripple current (Arms/105°C, 120Hz)	Part No.	WV (V _{dc})	Cap (μF)	Case size φD×L(mm)	tan δ	Rated ripple current (Arms/105°C, 120Hz)	Part No.
315	560	35 × 55	0.10	2.4	EKMQ3B1LGB561MA55M	400	390	35 × 55	0.10	2.0	EKMQ401LGB391MA55M
	680	35 × 65	0.15	2.9	EKMQ3B1LGB681MA65M		470	35 × 60	0.10	2.3	EKMQ401LGB471MA60M
	820	35 × 75	0.15	3.3	EKMQ3B1LGB821MA75M		560	35 × 70	0.15	2.7	EKMQ401LGB561MA70M
	1,000	35 × 80	0.15	3.8	EKMQ3B1LGB102MA80M		680	35 × 80	0.15	3.1	EKMQ401LGB681MA80M
	1,200	35 × 100	0.15	4.5	EKMQ3B1LGB122MAA0M		820	35 × 90	0.15	3.6	EKMQ401LGB821MA90M
	1,500	50 × 70	0.15	5.4	EKMQ3B1LGC152MC70M		1,000	50 × 65	0.15	4.2	EKMQ401LGC102MC65M
	1,800	50 × 75	0.15	6.0	EKMQ3B1LGC182MC75M		1,200	50 × 75	0.15	4.9	EKMQ401LGC122MC75M
	2,200	50 × 90	0.15	7.2	EKMQ3B1LGC222MC90M		1,500	50 × 85	0.15	5.8	EKMQ401LGC152MC85M
	2,700	50 × 100	0.15	8.4	EKMQ3B1LGC272MCA0M		2,200	63.5 × 85	0.15	8.1	EKMQ401LGC222MD85M
	3,300	63.5 × 85	0.15	9.9	EKMQ3B1LGC332MD85M		3,300	63.5 × 105	0.15	10.8	EKMQ401LGC332MDA5M
	3,900	63.5 × 96	0.15	11.3	EKMQ3B1LGC392MD96M		4,700	76.2 × 105	0.15	14.3	EKMQ401LGC472MEA5M
	4,700	76.2 × 85	0.15	13.1	EKMQ3B1LGC472ME85M		5,600	89 × 96	0.15	13.9	EKMQ401LGC562MF96M
	5,600	76.2 × 96	0.15	15.0	EKMQ3B1LGC562ME96M		6,800	89 × 115	0.15	16.6	EKMQ401LGC682MFB5M
	6,800	76.2 × 110	0.15	17.6	EKMQ3B1LGC682MEB0M		8,200	89 × 130	0.15	19.2	EKMQ401LGC822MFD0M
8,200	89 × 100	0.15	17.2	EKMQ3B1LGC822MFA0M	450	330	35 × 55	0.10	1.8	EKMQ451LGB331MA55M	
10,000	89 × 115	0.15	20.1	EKMQ3B1LGC103MFB5M		390	35 × 65	0.10	2.2	EKMQ451LGB391MA65M	
350	470	35 × 55	0.10	2.2		EKMQ351LGB471MA55M	470	35 × 75	0.10	2.5	EKMQ451LGB471MA75M
	560	35 × 60	0.10	2.5		EKMQ351LGB561MA60M	560	35 × 80	0.15	2.8	EKMQ451LGB561MA80M
	680	35 × 70	0.15	2.9		EKMQ351LGB681MA70M	680	35 × 100	0.15	3.5	EKMQ451LGB681MAA0M
	820	35 × 80	0.15	3.4		EKMQ351LGB821MA80M	820	35 × 110	0.15	4.1	EKMQ451LGB821MAB0M
	1,000	35 × 90	0.15	4.0		EKMQ351LGB102MA90M	1,000	50 × 80	0.15	4.6	EKMQ451LGC102MC80M
	1,200	50 × 65	0.15	4.6		EKMQ351LGC122MC65M	1,200	50 × 90	0.15	5.3	EKMQ451LGC122MC90M
	1,500	50 × 75	0.15	5.5		EKMQ351LGC152MC75M	1,500	50 × 105	0.15	6.4	EKMQ451LGC152MCA5M
	1,800	50 × 85	0.15	6.4		EKMQ351LGC182MC85M	2,200	63.5 × 96	0.15	8.5	EKMQ451LGC222MD96M
	2,200	50 × 100	0.15	7.6		EKMQ351LGC222MCA0M	3,300	63.5 × 130	0.15	11.9	EKMQ451LGC332MDD0M
	2,700	63.5 × 85	0.15	9.0		EKMQ351LGC272MD85M	4,700	76.2 × 130	0.15	15.7	EKMQ451LGC472MED0M
	3,900	76.2 × 80	0.15	11.7		EKMQ351LGC392ME80M	5,600	76.2 × 155	0.15	18.5	EKMQ451LGC562MEF5M
	5,600	76.2 × 105	0.15	15.6		EKMQ351LGC562MEA5M	5,600	89 × 120	0.15	15.3	EKMQ451LGC562MFC0M
	6,800	76.2 × 125	0.15	18.6	EKMQ351LGC682MEC5M	6,800	89 × 140	0.15	18.0	EKMQ451LGC682MFE0M	
	8,200	89 × 115	0.15	18.2	EKMQ351LGC822MFB5M	8,200	89 × 170	0.15	21.6	EKMQ451LGC822MFH0M	

◆RATED RIPPLE CURRENT MULTIPLIERS

● Frequency Multipliers

Frequency (Hz)	50	120	300	1k	3k
φ 35, 50	0.70	1.00	1.30	1.70	1.80
φ 63.5 to 89	0.80	1.00	1.10	1.15	1.15

The endurance of capacitors is reduced with internal heating produced by ripple current at the rate of halving the lifetime with every 5°C rise. When long life performance is required in actual use, the rms ripple current has to be reduced.

Return Group Chart



LARGE CAPACITANCE ALUMINUM ELECTROLYTIC CAPACITORS Standard screw terminals, 105°C

KMH Series

- Endurance with ripple current : 2,000 hours at 105°C
- RoHS Compliant

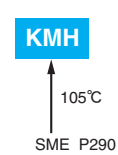

◆ SPECIFICATIONS

Items	Characteristics						
Category	-40 to +105°C (10 to 100V _{dc}) -25 to +105°C (160 to 400V _{dc})						
Temperature Range							
Rated Voltage Range	10 to 400V _{dc}						
Capacitance Tolerance	±20% (M) (at 20°C, 120Hz)						
Leakage Current	I=0.02CV or 5mA, whichever is smaller. Where, I : Max. leakage current (μA), C : Nominal capacitance (μF), V : Rated voltage (V) (at 20°C after 5 minutes)						
Dissipation Factor (tan δ)	Shall not exceed the values shown in the STANDARD RATINGS (at 20°C, 120Hz)						
Low Temperature Characteristics	Capacitance change 10 to 100V _{dc} : C(-40°C)/C(+20°C) ≥ 0.6 160 to 400V _{dc} : C(-25°C)/C(+20°C) ≥ 0.7 (at 120Hz)						
Insulation Resistance	When measured between the terminals that are connected to each other and to the mounting clamp on the insulating sleeve covering the case by using an insulation resistance meter of 500V _{dc} , the insulation resistance shall not be less than 100MΩ.						
Insulation Withstanding Voltage	When a voltage of 2,000V _{ac} is applied for 1 minute between the terminals that are connected to each other and to the mounting clamp on the insulating sleeve covering the case, there shall not be electrical damage.						
Endurance	The following specifications shall be satisfied when the capacitors are restored to 20°C after subjected to DC voltage with the rated ripple current is applied (the peak voltage shall not exceed the rated voltage) for 2,000 hours at 105°C. <table border="1"> <tr> <td>Capacitance change</td> <td>≤ ±20% of the initial value</td> </tr> <tr> <td>D.F. (tan δ)</td> <td>≤ 200% of the initial specified value</td> </tr> <tr> <td>Leakage current</td> <td>≤ The initial specified value</td> </tr> </table>	Capacitance change	≤ ±20% of the initial value	D.F. (tan δ)	≤ 200% of the initial specified value	Leakage current	≤ The initial specified value
Capacitance change	≤ ±20% of the initial value						
D.F. (tan δ)	≤ 200% of the initial specified value						
Leakage current	≤ The initial specified value						
Shelf Life	The following specifications shall be satisfied when the capacitors are restored to 20°C after exposing them for 500 hours at 105°C without voltage applied. Before the measurement, the capacitor shall be preconditioned by applying voltage according to Item 4.1 of JIS C 5101-4. <table border="1"> <tr> <td>Capacitance change</td> <td>≤ ±20% of the initial value</td> </tr> <tr> <td>D.F. (tan δ)</td> <td>≤ 200% of the initial specified value</td> </tr> <tr> <td>Leakage current</td> <td>≤ The initial specified value</td> </tr> </table>	Capacitance change	≤ ±20% of the initial value	D.F. (tan δ)	≤ 200% of the initial specified value	Leakage current	≤ The initial specified value
Capacitance change	≤ ±20% of the initial value						
D.F. (tan δ)	≤ 200% of the initial specified value						
Leakage current	≤ The initial specified value						

◆ DIMENSIONS (Screw-Mount) [mm]

● Terminal Code : LG

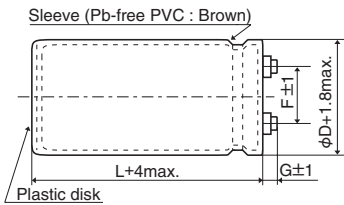

φ35 to φ63.5 : G=6
φ76.2 & φ89 : G=5

<Screw specifications>

Plus hexagon-headed screw : M5×0.8×10

Maximum screw tightening torque : 3.23Nm

* The screw and the mounting clamp are separately supplied and not attached to the product.

● Mounting Clamp Code : B

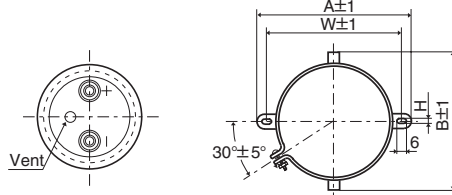

φD	A	B	W	H	F
35	58.0	44.0	48.0	3.5	12.7
50	78.0	64.0	68.0	4.5	22.4
63.5	90.0	76.0	80.0	4.5	28.0
76.2	104.5	90.0	93.5	4.5	31.5

● Mounting Clamp Code : C

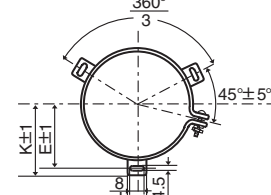

φD	E	K	J	F
50	32.5	37.0	14.0	22.4
63.5	38.1	43.5	14.0	28.0
76.2	44.5	50.0	14.0	31.5
89	50.8	56.5	16.0	31.5

◆ PART NUMBERING SYSTEM

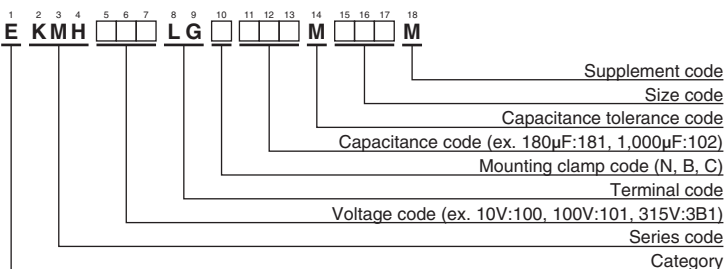

Please refer to "Product code guide (screw-mount terminal type)"

Return Group Chart



LARGE CAPACITANCE ALUMINUM ELECTROLYTIC CAPACITORS Standard screw terminals, 105°C

KMH Series

◆ STANDARD RATINGS

WV (V _{dc})	Cap (μF)	Case size φD×L(mm)	tan δ	Rated ripple current (Arms/105°C, 120Hz)	Part No.	WV (V _{dc})	Cap (μF)	Case size φD×L(mm)	tan δ	Rated ripple current (Arms/105°C, 120Hz)	Part No.	
10	27,000	35 × 50	0.45	4.90	EKMH100LGB273MA50M	35	56,000	50 × 100	0.40	11.4	EKMH350LGC563MA0M	
	33,000	35 × 50	0.50	5.10	EKMH100LGB333MA50M		68,000	50 × 120	0.40	13.6	EKMH350LGC683MCC0M	
	39,000	35 × 60	0.50	5.90	EKMH100LGB393MA60M		82,000	63.5 × 100	0.45	14.8	EKMH350LGC823MDA0M	
	47,000	35 × 80	0.50	7.10	EKMH100LGB473MA80M		100,000	63.5 × 120	0.45	17.6	EKMH350LGC104MDC0M	
	56,000	35 × 80	0.60	7.10	EKMH100LGB563MA80M		120,000	63.5 × 120	0.55	17.6	EKMH350LGC124MDC0M	
	68,000	35 × 100	0.60	8.50	EKMH100LGB683MAA0M		150,000	76.2 × 120	0.65	19.8	EKMH350LGC154MEC0M	
	82,000	35 × 100	0.65	8.90	EKMH100LGB823MAA0M		180,000	76.2 × 120	0.80	19.8	EKMH350LGC184MEC0M	
	100,000	35 × 120	0.65	10.7	EKMH100LGB104MAC0M		220,000	76.2 × 140	0.80	23.4	EKMH350LGC224MEE0M	
	120,000	50 × 80	0.75	11.0	EKMH100LGC124MC80M		270,000	89 × 140	1.00	25.5	EKMH350LGC274MFE0M	
	150,000	50 × 100	0.80	13.2	EKMH100LGC154MCA0M		50	3,900	35 × 50	0.20	2.80	EKMH500LGB392MA50M
	180,000	50 × 120	0.80	15.7	EKMH100LGC184MCC0M			4,700	35 × 50	0.20	3.10	EKMH500LGB472MA50M
	220,000	50 × 120	0.85	16.8	EKMH100LGC224MCC0M			5,600	35 × 50	0.20	3.30	EKMH500LGB562MA50M
	270,000	63.5 × 120	1.00	19.6	EKMH100LGC274MDC0M			6,800	35 × 50	0.25	3.30	EKMH500LGB682MA50M
	330,000	63.5 × 120	1.20	19.7	EKMH100LGC334MDC0M			8,200	35 × 60	0.25	3.80	EKMH500LGB822MA60M
	390,000	76.2 × 120	1.50	21.3	EKMH100LGC394MEC0M			10,000	35 × 80	0.25	4.60	EKMH500LGB103MA80M
	470,000	76.2 × 120	1.80	21.4	EKMH100LGC474MEC0M			12,000	35 × 80	0.25	5.10	EKMH500LGB123MA80M
	560,000	76.2 × 140	2.00	23.6	EKMH100LGC564MEE0M			15,000	35 × 80	0.25	5.70	EKMH500LGB153MA80M
	680,000	89 × 140	2.40	26.0	EKMH100LGC684MFE0M			18,000	35 × 100	0.25	6.70	EKMH500LGB183MAA0M
	16	18,000	35 × 50	0.40	4.20			EKMH160LGB183MA50M	22,000	35 × 120	0.25	8.10
22,000		35 × 50	0.40	4.70	EKMH160LGB223MA50M	27,000		50 × 80	0.25	9.10	EKMH500LGC273MC80M	
27,000		35 × 60	0.40	5.50	EKMH160LGB273MA60M	33,000		50 × 100	0.25	11.1	EKMH500LGC333MCA0M	
33,000		35 × 60	0.45	5.70	EKMH160LGB333MA60M	39,000		50 × 120	0.25	13.1	EKMH500LGC393MCC0M	
39,000		35 × 80	0.45	6.80	EKMH160LGB393MA80M	47,000		50 × 120	0.30	13.9	EKMH500LGC473MCC0M	
47,000		35 × 80	0.50	7.10	EKMH160LGB473MA80M	56,000		63.5 × 100	0.35	13.9	EKMH500LGC563MDA0M	
56,000		35 × 100	0.50	8.40	EKMH160LGB563MAA0M	68,000		63.5 × 120	0.35	16.6	EKMH500LGC683MDC0M	
68,000		35 × 100	0.55	8.80	EKMH160LGB683MAA0M	82,000		76.2 × 120	0.40	18.9	EKMH500LGC823MEC0M	
82,000		50 × 80	0.55	10.7	EKMH160LGC823MC80M	100,000		76.2 × 120	0.45	19.5	EKMH500LGC104MEC0M	
100,000		50 × 80	0.65	10.8	EKMH160LGC104MC80M	120,000		76.2 × 120	0.55	19.5	EKMH500LGC124MEC0M	
120,000		50 × 100	0.65	13.1	EKMH160LGC124MCA0M	150,000	89 × 140	0.60	23.9	EKMH500LGC154MFE0M		
150,000		50 × 120	0.70	15.3	EKMH160LGC154MCC0M	180,000	89 × 140	0.75	23.9	EKMH500LGC184MFE0M		
180,000		50 × 120	0.80	15.7	EKMH160LGC184MCC0M	63	2,700	35 × 50	0.20	2.30	EKMH630LGB272MA50M	
220,000		63.5 × 120	0.85	19.2	EKMH160LGC224MDC0M		3,300	35 × 50	0.20	2.50	EKMH630LGB332MA50M	
270,000		63.5 × 120	1.00	19.6	EKMH160LGC274MDC0M		3,900	35 × 50	0.20	2.80	EKMH630LGB392MA50M	
330,000		76.2 × 120	1.30	21.1	EKMH160LGC334MEC0M		4,700	35 × 50	0.20	3.10	EKMH630LGB472MA50M	
390,000		76.2 × 120	1.50	21.3	EKMH160LGC394MEC0M		5,600	35 × 60	0.20	3.50	EKMH630LGB562MA60M	
470,000		76.2 × 140	1.60	24.2	EKMH160LGC474MEE0M		6,800	35 × 60	0.20	3.90	EKMH630LGB682MA60M	
560,000		89 × 140	2.00	28.1	EKMH160LGC564MFE0M		8,200	35 × 80	0.20	4.70	EKMH630LGB822MA80M	
680,000	89 × 140	2.40	28.5	EKMH160LGC684MFE0M	10,000		35 × 80	0.25	4.70	EKMH630LGB103MA80M		
25	12,000	35 × 50	0.35	3.70	EKMH250LGB123MA50M		12,000	35 × 100	0.25	5.50	EKMH630LGB123MAA0M	
	15,000	35 × 50	0.35	4.10	EKMH250LGB153MA50M		15,000	35 × 120	0.25	6.60	EKMH630LGB153MAC0M	
	18,000	35 × 60	0.35	4.80	EKMH250LGB183MA60M		18,000	50 × 80	0.25	7.40	EKMH630LGC183MC80M	
	22,000	35 × 60	0.35	5.30	EKMH250LGB223MA60M		22,000	50 × 100	0.25	9.00	EKMH630LGC223MCA0M	
	27,000	35 × 80	0.35	6.40	EKMH250LGB273MA80M		27,000	50 × 120	0.25	10.9	EKMH630LGC273MCC0M	
	33,000	35 × 80	0.40	6.70	EKMH250LGB333MA80M		33,000	50 × 120	0.25	12.0	EKMH630LGC333MCC0M	
	39,000	35 × 100	0.40	7.80	EKMH250LGB393MAA0M		39,000	63.5 × 100	0.30	12.5	EKMH630LGC393MDA0M	
	47,000	35 × 120	0.40	9.30	EKMH250LGB473MAC0M		47,000	63.5 × 120	0.30	14.9	EKMH630LGC473MDC0M	
	56,000	50 × 80	0.45	9.70	EKMH250LGC563MC80M		56,000	63.5 × 120	0.30	16.3	EKMH630LGC563MDC0M	
	68,000	50 × 100	0.45	11.2	EKMH250LGC683MCA0M		68,000	76.2 × 120	0.35	18.4	EKMH630LGC683MEC0M	
	82,000	50 × 100	0.50	11.2	EKMH250LGC823MCA0M		82,000	76.2 × 140	0.40	20.0	EKMH630LGC823MEE0M	
	100,000	50 × 120	0.50	14.8	EKMH250LGC104MCC0M	100,000	76.2 × 140	0.50	20.0	EKMH630LGC104MEE0M		
	120,000	63.5 × 100	0.65	14.9	EKMH250LGC124MDA0M	120,000	89 × 140	0.60	21.8	EKMH630LGC124MFE0M		
	150,000	63.5 × 120	0.65	17.9	EKMH250LGC154MDC0M	80	2,200	35 × 50	0.15	2.40	EKMH800LGB272MA50M	
	180,000	63.5 × 120	0.80	17.9	EKMH250LGC184MDC0M		2,700	35 × 50	0.15	2.70	EKMH800LGB272MA50M	
	220,000	76.2 × 120	0.85	21.3	EKMH250LGC224MEC0M		3,300	35 × 50	0.15	3.00	EKMH800LGB332MA50M	
	270,000	76.2 × 120	1.00	21.7	EKMH250LGC274MEC0M		3,900	35 × 60	0.15	3.40	EKMH800LGB392MA60M	
	330,000	76.2 × 140	1.20	23.4	EKMH250LGC334MEE0M		4,700	35 × 60	0.15	3.70	EKMH800LGB472MA60M	
	390,000	89 × 140	1.50	24.9	EKMH250LGC394MFE0M		5,600	35 × 80	0.15	4.50	EKMH800LGB562MA80M	
35	8,200	35 × 50	0.30	3.30	EKMH350LGB822MA50M		6,800	35 × 80	0.15	4.90	EKMH800LGB682MA80M	
	10,000	35 × 50	0.30	3.60	EKMH350LGB103MA50M		8,200	35 × 100	0.20	5.10	EKMH800LGB822MAA0M	
	12,000	35 × 60	0.30	4.20	EKMH350LGB123MA60M		10,000	35 × 120	0.20	6.10	EKMH800LGB103MAC0M	
	15,000	35 × 60	0.30	4.70	EKMH350LGB153MA60M		12,000	50 × 80	0.20	6.70	EKMH800LGC123MC80M	
	18,000	35 × 80	0.30	5.70	EKMH350LGB183MA80M		15,000	50 × 100	0.20	8.30	EKMH800LGC153MCA0M	
	22,000	35 × 80	0.30	6.30	EKMH350LGB223MA80M		18,000	50 × 120	0.20	9.90	EKMH800LGC183MCC0M	
	27,000	35 × 100	0.30	7.50	EKMH350LGB273MAA0M		22,000	50 × 120	0.20	11.0	EKMH800LGC223MCC0M	
	33,000	35 × 120	0.30	9.00	EKMH350LGB333MAC0M		27,000	63.5 × 100	0.25	11.4	EKMH800LGC273MDA0M	
	39,000	50 × 80	0.35	9.20	EKMH350LGC393MC80M		33,000	76.2 × 100	0.25	13.9	EKMH800LGC333MEA0M	
	47,000	50 × 100	0.35	11.2	EKMH350LGC473MCA0M		39,000	76.2 × 100	0.30	13.9	EKMH800LGC393MEA0M	

Return Group Chart



LARGE CAPACITANCE ALUMINUM ELECTROLYTIC CAPACITORS Standard screw terminals, 105°C



◆ STANDARD RATINGS

WV (V _{dc})	Cap (μF)	Case size φD×L(mm)	tan δ	Rated ripple current (Arms/105°C, 120Hz)	Part No.	WV (V _{dc})	Cap (μF)	Case size φD×L(mm)	tan δ	Rated ripple current (Arms/105°C, 120Hz)	Part No.	
80	47,000	76.2 × 120	0.30	16.5	EKM800LGC473MEC0M	250	330	35 × 50	0.15	0.90	EKM251LGB331MA50M	
	56,000	76.2 × 120	0.30	18.1	EKM800LGC563MEC0M		390	35 × 50	0.15	1.00	EKM251LGB391MA50M	
	68,000	76.2 × 140	0.35	19.7	EKM800LGC683MEE0M		470	35 × 50	0.15	1.10	EKM251LGB471MA50M	
	82,000	89 × 140	0.40	22.1	EKM800LGC823MFE0M		560	35 × 50	0.15	1.20	EKM251LGB561MA50M	
100	1,800	35 × 50	0.10	2.70	EKM101LGB182MA50M		680	35 × 60	0.15	1.40	EKM251LGB681MA60M	
	2,200	35 × 50	0.10	3.00	EKM101LGB222MA50M		820	35 × 80	0.15	1.60	EKM251LGB821MA80M	
	2,700	35 × 60	0.10	3.50	EKM101LGB272MA60M		1,000	35 × 80	0.20	1.60	EKM251LGB102MA80M	
	3,300	35 × 80	0.10	4.20	EKM101LGB332MA80M		1,200	35 × 80	0.20	1.80	EKM251LGB122MA80M	
	3,900	35 × 80	0.12	4.20	EKM101LGB392MA80M		1,500	35 × 100	0.20	2.10	EKM251LGB152MAA0M	
	4,700	35 × 100	0.12	5.00	EKM101LGB472MAA0M		1,800	35 × 120	0.20	2.50	EKM251LGB182MAC0M	
	5,600	35 × 100	0.12	5.40	EKM101LGB562MAA0M		2,200	50 × 100	0.20	2.90	EKM251LGB102MA80M	
	6,800	35 × 120	0.15	5.80	EKM101LGB682MAC0M		2,700	50 × 100	0.20	3.50	EKM251LGC272MCA0M	
	8,200	50 × 80	0.15	6.40	EKM101LGC822MC80M		3,300	50 × 120	0.20	4.20	EKM251LGC332MCC0M	
	10,000	50 × 100	0.15	7.80	EKM101LGC103MCA0M		3,900	50 × 120	0.20	4.60	EKM251LGC392MCC0M	
	12,000	50 × 120	0.15	9.30	EKM101LGC123MCC0M		10,000	63.5 × 120	0.20	5.70	EKM251LGC103MEE0M	
	15,000	50 × 120	0.15	10.4	EKM101LGC153MCC0M		5,600	63.5 × 120	0.20	6.30	EKM251LGC562MDC0M	
	18,000	63.5 × 100	0.20	10.4	EKM101LGC183MDA0M		6,800	76.2 × 120	0.20	7.70	EKM251LGC682MEC0M	
	22,000	63.5 × 120	0.20	12.5	EKM101LGC223MDC0M		8,200	76.2 × 120	0.20	8.40	EKM251LGC822MEC0M	
	27,000	76.2 × 120	0.25	13.7	EKM101LGC273MEC0M		10,000	76.2 × 140	0.20	10.0	EKM251LGC103MEE0M	
	33,000	76.2 × 120	0.25	15.2	EKM101LGC333MEC0M		12,000	89 × 140	0.20	11.9	EKM251LGC123MFE0M	
39,000	76.2 × 140	0.30	16.1	EKM101LGC393MEE0M	315		180	35 × 50	0.10	0.80	EKM315LGB181MA50M	
47,000	89 × 140	0.30	19.3	EKM101LGC473MFE0M			220	35 × 50	0.10	0.90	EKM315LGB221MA50M	
56,000	89 × 140	0.30	21.1	EKM101LGC563MFE0M			270	35 × 50	0.10	1.00	EKM315LGB271MA50M	
160	560	35 × 50	0.15	1.20			EKM161LGB561MA50M	330	35 × 50	0.10	1.10	EKM315LGB331MA50M
	680	35 × 50	0.15	1.30			EKM161LGB681MA50M	390	35 × 50	0.10	1.20	EKM315LGB391MA50M
	820	35 × 50	0.15	1.40			EKM161LGB821MA50M	470	35 × 60	0.10	1.40	EKM315LGB471MA60M
	1,000	35 × 50	0.15	1.60			EKM161LGB102MA50M	560	35 × 60	0.10	1.50	EKM315LGB561MA60M
	1,200	35 × 60	0.15	1.90			EKM161LGB122MA60M	680	35 × 80	0.10	1.70	EKM315LGB681MA80M
	1,500	35 × 60	0.15	2.10			EKM161LGB152MA60M	820	35 × 80	0.15	1.70	EKM315LGB821MA80M
	1,800	35 × 80	0.15	2.50			EKM161LGB182MA80M	1,000	35 × 100	0.15	2.00	EKM315LGB102MAA0M
	2,200	35 × 80	0.15	2.80			EKM161LGB222MA80M	1,200	35 × 120	0.15	2.40	EKM315LGB122MAC0M
	2,700	35 × 100	0.15	3.30			EKM161LGB272MAA0M	1,500	50 × 80	0.15	2.70	EKM315LGC152MC80M
	3,300	35 × 120	0.15	3.80			EKM161LGB332MAC0M	1,800	50 × 100	0.15	3.30	EKM315LGC182MCA0M
	3,900	50 × 80	0.20	3.80			EKM161LGC392MC80M	2,200	50 × 120	0.15	4.00	EKM315LGC222MCC0M
	4,700	50 × 100	0.20	4.60			EKM161LGC472MCA0M	2,700	50 × 120	0.15	4.40	EKM315LGC272MCC0M
	5,600	50 × 100	0.20	5.10			EKM161LGC562MCA0M	3,300	63.5 × 100	0.15	5.10	EKM315LGC332MDA0M
	6,800	50 × 120	0.20	6.10	EKM161LGC682MCC0M		3,900	63.5 × 120	0.15	6.00	EKM315LGC392MDC0M	
	8,200	63.5 × 100	0.20	7.00	EKM161LGC822MDA0M		4,700	76.2 × 100	0.15	6.80	EKM315LGC472MEA0M	
	10,000	63.5 × 120	0.20	8.40	EKM161LGC103MDC0M		5,600	76.2 × 120	0.15	8.00	EKM315LGC562MED0M	
12,000	76.2 × 100	0.20	9.40	EKM161LGC123MEA0M	6,800		76.2 × 130	0.15	9.20	EKM315LGC682MED0M		
15,000	76.2 × 120	0.20	11.4	EKM161LGC153MEC0M	8,200	89 × 140	0.15	11.4	EKM315LGC822MFE0M			
18,000	76.2 × 140	0.20	13.4	EKM161LGC183MEE0M	10,000	89 × 140	0.15	12.6	EKM315LGC103MFE0M			
22,000	89 × 140	0.25	14.5	EKM161LGC223MFE0M	350	180	35 × 50	0.10	0.80	EKM351LGB181MA50M		
27,000	89 × 140	0.25	16.0	EKM161LGC273MFE0M		220	35 × 50	0.10	0.90	EKM351LGB221MA50M		
200	330	35 × 50	0.15	0.90		EKM201LGB331MA50M	270	35 × 50	0.10	1.00	EKM351LGB271MA50M	
	390	35 × 50	0.15	1.00		EKM201LGB391MA50M	330	35 × 50	0.10	1.10	EKM351LGB331MA50M	
	470	35 × 50	0.15	1.10		EKM201LGB471MA50M	390	35 × 60	0.10	1.30	EKM351LGB391MA60M	
	560	35 × 50	0.15	1.20		EKM201LGB561MA50M	470	35 × 60	0.10	1.40	EKM351LGB471MA60M	
	680	35 × 50	0.15	1.30		EKM201LGB681MA50M	560	35 × 80	0.10	1.60	EKM351LGB561MA80M	
	820	35 × 50	0.15	1.40		EKM201LGB821MA50M	680	35 × 80	0.15	1.60	EKM351LGB681MA80M	
	1,000	35 × 60	0.15	1.70		EKM201LGB102MA60M	820	35 × 100	0.15	1.80	EKM351LGB821MAA0M	
	1,200	35 × 60	0.15	1.90		EKM201LGB122MA60M	1,000	35 × 120	0.15	2.20	EKM351LGB122MAC0M	
	1,500	35 × 80	0.15	2.30		EKM201LGB152MA80M	1,200	50 × 80	0.15	2.40	EKM351LGC122MC80M	
	1,800	35 × 80	0.15	2.50		EKM201LGB182MA80M	1,500	50 × 100	0.15	3.00	EKM351LGC152MCA0M	
	2,200	35 × 100	0.15	3.00		EKM201LGB222MAA0M	1,800	50 × 120	0.15	3.60	EKM351LGC182MCC0M	
	2,700	35 × 120	0.15	3.60		EKM201LGB272MAC0M	2,200	50 × 120	0.15	4.00	EKM351LGC222MCC0M	
	3,300	50 × 80	0.15	4.10		EKM201LGC332MC80M	2,700	63.5 × 100	0.15	4.60	EKM351LGC272MDA0M	
	3,900	50 × 100	0.15	4.90		EKM201LGC392MCA0M	3,900	76.2 × 120	0.15	6.70	EKM351LGC392MEC0M	
	4,700	63.5 × 100	0.20	5.30	EKM201LGC472MDA0M	5,600	76.2 × 130	0.15	8.30	EKM351LGC562MED0M		
	5,600	63.5 × 100	0.20	5.80	EKM201LGC562MDA0M	6,800	76.2 × 140	0.15	9.50	EKM351LGC682MEE0M		
6,800	63.5 × 120	0.20	6.90	EKM201LGC682MDC0M	8,200	89 × 140	0.15	11.4	EKM351LGC822MFE0M			
8,200	63.5 × 120	0.20	7.60	EKM201LGC822MDC0M	400	180	35 × 50	0.10	0.80	EKM401LGB181MA50M		
10,000	76.2 × 120	0.20	9.30	EKM201LGC103MEC0M		220	35 × 50	0.10	0.90	EKM401LGB221MA50M		
12,000	76.2 × 120	0.20	10.2	EKM201LGC123MEC0M		270	35 × 50	0.10	1.00	EKM401LGB271MA50M		
15,000	76.2 × 140	0.20	12.2	EKM201LGC153MEE0M		330	35 × 60	0.10	1.20	EKM401LGB331MA60M		
18,000	89 × 140	0.25	13.1	EKM201LGC183MFE0M		390	35 × 60	0.10	1.30	EKM401LGB391MA60M		
250	270	35 × 50	0.15	0.80		EKM251LGB271MA50M	470	35 × 80	0.10	1.40	EKM401LGB471MA80M	

Product specifications in this catalog are subject to change without notice. Request our product specifications before purchase and/or use. Please use our products based on the information contained in this catalog and product specifications.

Return Group Chart



LARGE CAPACITANCE ALUMINUM ELECTROLYTIC CAPACITORS Standard screw terminals, 105°C

KMHSeries

◆STANDARD RATINGS

WV (V _{dc})	Cap (μF)	Case size φD×L(mm)	tan δ	Rated ripple current (Arms/105°C, 120Hz)	Part No.	WV (V _{dc})	Cap (μF)	Case size φD×L(mm)	tan δ	Rated ripple current (Arms/105°C, 120Hz)	Part No.
400	560	35 × 80	0.15	1.40	EKMH401LGB561MA80M	400	2,200	63.5 × 100	0.15	4.20	EKMH401LGC222MDA0M
	680	35 × 100	0.15	1.70	EKMH401LGB681MAA0M		3,300	63.5 × 120	0.15	5.50	EKMH401LGC332MDC0M
	820	35 × 120	0.15	2.00	EKMH401LGB821MAC0M		4,700	76.2 × 130	0.15	7.60	EKMH401LGC472MED0M
	1,000	50 × 80	0.15	2.20	EKMH401LGC102MC80M		5,600	89 × 140	0.15	9.40	EKMH401LGC562MFE0M
	1,200	50 × 100	0.15	2.70	EKMH401LGC122MCA0M		6,800	89 × 140	0.15	10.4	EKMH401LGC682MFE0M
	1,500	50 × 120	0.15	3.30	EKMH401LGC152MCC0M						

◆RATED RIPPLE CURRENT MULTIPLIERS

● Frequency Multipliers

Rated voltage (V _{dc})	Case diameter (mm)	Frequency (Hz)					
		50	120	300	1k	10k	50k
10 to 50	φ35 to φ89	0.95	1.00	1.03	1.05	1.09	1.12
63 & 80	φ35	0.90	1.00	1.06	1.10	1.18	1.22
	φ50 to φ89	0.95	1.00	1.03	1.05	1.09	1.12
100	φ35	0.82	1.00	1.12	1.22	1.30	1.33
	φ50	0.90	1.00	1.06	1.10	1.18	1.22
	φ63.5 to φ89	0.95	1.00	1.03	1.05	1.09	1.12
160 to 250	φ35	0.80	1.00	1.19	1.34	1.46	1.52
	φ50 & φ63.5	0.81	1.00	1.14	1.26	1.36	1.41
	φ76.2 & φ89	0.82	1.00	1.12	1.22	1.30	1.33
315 to 400	φ35 to φ89	0.80	1.00	1.19	1.34	1.46	1.52

The endurance of capacitors is reduced with internal heating produced by ripple current at the rate of halving the lifetime with every 5°C rise. When long life performance is required in actual use, the rms ripple current has to be reduced.

Return Group Chart



LARGE CAPACITANCE ALUMINUM ELECTROLYTIC CAPACITORS Inverter-use screw terminal, 85°C

RWH Series

- Downsized and high ripple current from RWG series
- Endurance with ripple current : 5,000 hours at 85°C
- RoHS Compliant

RWH

↓
Downsized
RWG P300



◆ SPECIFICATIONS

Items	Characteristics								
Category									
Temperature Range	-25 to +85°C								
Rated Voltage Range	350 to 450V _{dc}								
Capacitance Tolerance	±20% (M) (at 20°C, 120Hz)								
Leakage Current	I=0.02CV or 5mA, whichever is smaller. Where, I : Max. leakage current (μA), C : Nominal capacitance (μF), V : Rated voltage (V) (at 20°C after 5 minutes)								
Dissipation Factor (tan δ)	0.25 max. (at 20°C, 120Hz)								
Low Temperature Characteristics	Capacitance change $C(-25^{\circ}\text{C})/C(+20^{\circ}\text{C}) \geq 0.7$ (at 120Hz)								
Insulation Resistance	When measured between the terminals that are connected to each other and to the mounting clamp on the insulating sleeve covering the case by using an insulation resistance meter of 500V _{dc} , the insulation resistance shall not be less than 100MΩ.								
Insulation Withstanding Voltage	When a voltage of 2,000V _{ac} is applied for 1 minute between the terminals that are connected to each other and to the mounting clamp on the insulating sleeve covering the case, there shall not be electrical damage.								
Endurance	The following specifications shall be satisfied when the capacitors are restored to 20°C after subjected to DC voltage with the rated ripple current is applied (the peak voltage shall not exceed the rated voltage) for 5,000 hours at 85°C. <table border="1"> <tr> <td>Capacitance change</td> <td>≤ ±20% of the initial value</td> </tr> <tr> <td>D.F. (tan δ)</td> <td>≤ 200% of the initial specified value</td> </tr> <tr> <td>Leakage current</td> <td>≤ The initial specified value</td> </tr> </table>	Capacitance change	≤ ±20% of the initial value	D.F. (tan δ)	≤ 200% of the initial specified value	Leakage current	≤ The initial specified value		
Capacitance change	≤ ±20% of the initial value								
D.F. (tan δ)	≤ 200% of the initial specified value								
Leakage current	≤ The initial specified value								
Useful life	The following specifications shall be satisfied when the capacitors are restored to 20°C after subjected to DC voltage with the rated ripple current is applied (the peak voltage shall not exceed the rated voltage) for 8,000 hours at 85°C. <table border="1"> <tr> <td>Capacitance change</td> <td>≤ ±30% of the initial value</td> </tr> <tr> <td>D.F. (tan δ)</td> <td>≤ 300% of the initial specified value</td> </tr> <tr> <td>Leakage current</td> <td>≤ The initial specified value</td> </tr> <tr> <td>Failure rate</td> <td>≤ 1%</td> </tr> </table>	Capacitance change	≤ ±30% of the initial value	D.F. (tan δ)	≤ 300% of the initial specified value	Leakage current	≤ The initial specified value	Failure rate	≤ 1%
Capacitance change	≤ ±30% of the initial value								
D.F. (tan δ)	≤ 300% of the initial specified value								
Leakage current	≤ The initial specified value								
Failure rate	≤ 1%								
Shelf Life	The following specifications shall be satisfied when the capacitors are restored to 20°C after exposing them for 500 hours at 85°C without voltage applied. Before the measurement, the capacitor shall be preconditioned by applying voltage according to Item 4.1 of JIS C 5101-4. <table border="1"> <tr> <td>Capacitance change</td> <td>≤ ±20% of the initial value</td> </tr> <tr> <td>D.F. (tan δ)</td> <td>≤ 200% of the initial specified value</td> </tr> <tr> <td>Leakage current</td> <td>≤ The initial specified value</td> </tr> </table>	Capacitance change	≤ ±20% of the initial value	D.F. (tan δ)	≤ 200% of the initial specified value	Leakage current	≤ The initial specified value		
Capacitance change	≤ ±20% of the initial value								
D.F. (tan δ)	≤ 200% of the initial specified value								
Leakage current	≤ The initial specified value								

◆ DIMENSIONS (Screw-Mount) [mm]

● Terminal Code : LG

● Mounting Clamp Code : B

● Mounting Clamp Code : C

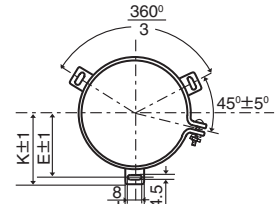
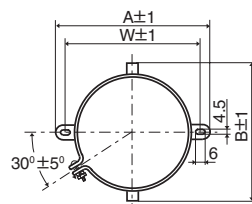
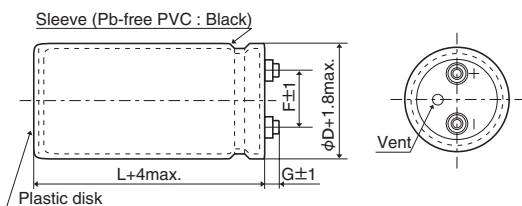

φD	A	B	W	F
63.5	90.0	76.0	80.0	28.0
76.2	104.5	90.0	93.5	31.5

φD	E	K	F	J
63.5	38.1	43.5	28.0	14.0
76.2	44.5	50.0	31.5	14.0
89	50.8	56.5	31.5	16.0

φ63.5, φ76.2 : G=6
φ89 : G=4

<Screw specifications>

Plus hexagon-headed screw : M5×0.8×10

Maximum screw tightening torque : 3.23Nm

* The screw and the mounting clamp are separately supplied and not attached to the product.

◆ PART NUMBERING SYSTEM

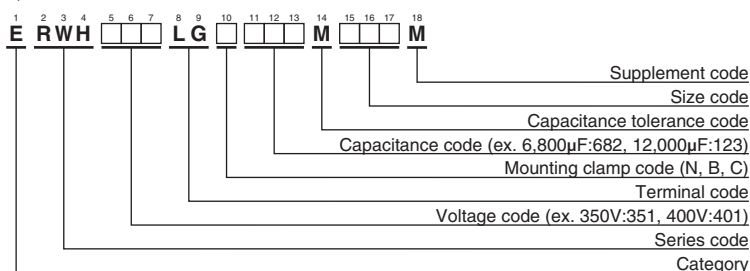

Please refer to "Product code guide (screw-mount terminal type)"

Return Group Chart



LARGE CAPACITANCE ALUMINUM ELECTROLYTIC CAPACITORS Inverter-use screw terminal, 85°C

RWHSeries

◆STANDARD RATINGS

WV (V _{dc})	Cap (μF)	Case size φD×L(mm)	tan δ	Rated ripple current (Arms/85°C, 120Hz)	Part No.	WV (V _{dc})	Cap (μF)	Case size φD×L(mm)	tan δ	Rated ripple current (Arms/85°C, 120Hz)	Part No.	
350	4,700	63.5 × 105	0.25	16.3	ERWH351LGC472MDA5M	400	8,200	76.2 × 135	0.25	26.5	ERWH401LGC822MED5M	
	5,600	63.5 × 125	0.25	19.2	ERWH351LGC562MDC5M		10,000	76.2 × 160	0.25	31.6	ERWH401LGC103MEG0M	
	6,800	63.5 × 145	0.25	22.6	ERWH351LGC682MDE5M		10,000	89 × 130	0.25	28.3	ERWH401LGC103MFD0M	
	6,800	76.2 × 105	0.25	21.7	ERWH351LGC682MEA5M		12,000	89 × 150	0.25	33.0	ERWH401LGC123MFF0M	
	8,200	63.5 × 165	0.25	26.3	ERWH351LGC822MDG5M		15,000	89 × 180	0.25	39.9	ERWH401LGC153MFJ0M	
	8,200	76.2 × 120	0.25	25.2	ERWH351LGC822MEC0M		450	3,300	63.5 × 105	0.25	13.6	ERWH451LGC332MDA5M
	10,000	76.2 × 140	0.25	29.8	ERWH351LGC103MEE0M			3,900	63.5 × 125	0.25	16.0	ERWH451LGC392MDC5M
	12,000	76.2 × 165	0.25	35.1	ERWH351LGC123MEG5M			4,700	63.5 × 145	0.25	18.7	ERWH451LGC472MDE5M
	15,000	89 × 155	0.25	37.5	ERWH351LGC153MFF5M			4,700	76.2 × 105	0.25	18.0	ERWH451LGC472MEA5M
18,000	89 × 180	0.25	43.8	ERWH351LGC183MFJ0M	5,600	63.5 × 165		0.25	21.7	ERWH451LGC562MDG5M		
400	3,900	63.5 × 100	0.25	14.5	ERWH401LGC392MDA0M	5,600		76.2 × 120	0.25	20.8	ERWH451LGC562MEC0M	
	4,700	63.5 × 120	0.25	17.2	ERWH401LGC472MDC0M	6,800		76.2 × 140	0.25	24.5	ERWH451LGC682MEE0M	
	5,600	63.5 × 135	0.25	19.8	ERWH401LGC562MDD5M	8,200		76.2 × 165	0.25	29.0	ERWH451LGC822MEG5M	
	5,600	76.2 × 105	0.25	19.7	ERWH401LGC562MEA5M	8,200		89 × 135	0.25	26.1	ERWH451LGC822MFD5M	
	6,800	63.5 × 160	0.25	23.5	ERWH401LGC682MDG0M	10,000	89 × 155	0.25	30.5	ERWH451LGC103MFF5M		
	6,800	76.2 × 115	0.25	22.5	ERWH401LGC682MEB5M	12,000	89 × 190	0.25	36.6	ERWH451LGC123MFK0M		

◆RATED RIPPLE CURRENT MULTIPLIERS

● Frequency Multipliers

Frequency (Hz)	50	120	300	1k	3k
Coefficient	0.8	1.0	1.1	1.3	1.4

Note: The endurance of capacitors is reduced with internal heating produced by ripple current at the rate of halving the lifetime with every 5 to 10°C rise. When long life performance is required in actual use, the rms ripple current has to be reduced. Also, for the RWH series capacitors, using them at operating voltage less than their rated voltage can extend their lifetime. For details, please contact a representative of Nippon Chemi-Con.

◆USEFUL LIFE

Useful life depending on the ambient temperature Tx under ripple current operating conditions

Io : Rated ripple current (Arms/85°C, 120Hz)
Ix : Operating ripple current (Arms/120Hz)

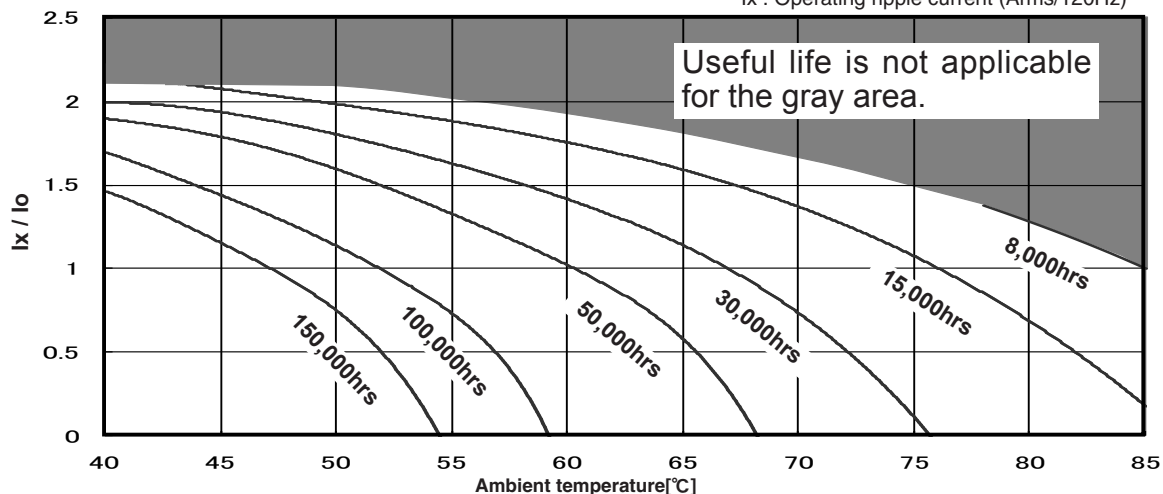

◆Warning !

Useful life shall indicate the end of the life time without exceeding the specified failure rate. It's generally known that Aluminum Electrolytic Capacitors have wear-out failure mode with gradual deterioration of the electrical parameters and should have large number of the failure rate at the end of life. The useful life time is specified by a certain failure rate. It's not a guaranteed specification.

Generally the maximum life time is 15 years (131,000hours) considering sealing material deteriorate. When a longer life time is required for your application, please consult us.

Return Group Chart



LARGE CAPACITANCE ALUMINUM ELECTROLYTIC CAPACITORS Inverter-use screw terminal, 85°C

RWG Series

- Downsized, high ripple version of RWF series
- 20% better ripple current at 300Hz than RWF series
- Endurance with ripple current : 5,000 hours at 85°C
- RoHS Compliant

RWG

↓
Downsized
RWF P302



◆ SPECIFICATIONS

Items	Characteristics						
Category							
Temperature Range	-25 to +85°C						
Rated Voltage Range	350 to 450V _{dc}						
Capacitance Tolerance	±20% (M) (at 20°C, 120Hz)						
Leakage Current	I=0.02CV or 5mA, whichever is smaller. Where, I : Max. leakage current (μA), C : Nominal capacitance (μF), V : Rated voltage (V) (at 20°C after 5 minutes)						
Dissipation Factor (tan δ)	0.25 max. (at 20°C, 120Hz)						
Low Temperature Characteristics	Capacitance change $C(-25^{\circ}\text{C})/C(+20^{\circ}\text{C}) \geq 0.7$ (at 120Hz)						
Insulation Resistance	When measured between the terminals that are connected to each other and to the mounting clamp on the insulating sleeve covering the case by using an insulation resistance meter of 500V _{dc} , the insulation resistance shall not be less than 100MΩ.						
Insulation Withstanding Voltage	When a voltage of 2,000V _{ac} is applied for 1 minute between the terminals that are connected to each other and to the mounting clamp on the insulating sleeve covering the case, there shall not be electrical damage.						
Endurance	The following specifications shall be satisfied when the capacitors are restored to 20°C after subjected to DC voltage with the rated ripple current is applied (the peak voltage shall not exceed the rated voltage) for 5,000 hours at 85°C. <table border="1"> <tr> <td>Capacitance change</td> <td>≤ ±20% of the initial value</td> </tr> <tr> <td>D.F. (tan δ)</td> <td>≤ 200% of the initial specified value</td> </tr> <tr> <td>Leakage current</td> <td>≤ The initial specified value</td> </tr> </table>	Capacitance change	≤ ±20% of the initial value	D.F. (tan δ)	≤ 200% of the initial specified value	Leakage current	≤ The initial specified value
Capacitance change	≤ ±20% of the initial value						
D.F. (tan δ)	≤ 200% of the initial specified value						
Leakage current	≤ The initial specified value						
Shelf Life	The following specifications shall be satisfied when the capacitors are restored to 20°C after exposing them for 500 hours at 85°C without voltage applied. Before the measurement, the capacitor shall be preconditioned by applying voltage according to Item 4.1 of JIS C 5101-4. <table border="1"> <tr> <td>Capacitance change</td> <td>≤ ±20% of the initial value</td> </tr> <tr> <td>D.F. (tan δ)</td> <td>≤ 200% of the initial specified value</td> </tr> <tr> <td>Leakage current</td> <td>≤ The initial specified value</td> </tr> </table>	Capacitance change	≤ ±20% of the initial value	D.F. (tan δ)	≤ 200% of the initial specified value	Leakage current	≤ The initial specified value
Capacitance change	≤ ±20% of the initial value						
D.F. (tan δ)	≤ 200% of the initial specified value						
Leakage current	≤ The initial specified value						

◆ DIMENSIONS (Screw-Mount) [mm]

● Terminal Code : LG

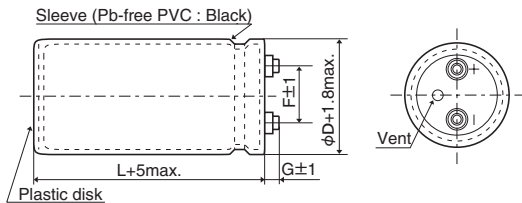

- φ50 : G=6
- φ63.5, φ76.2 : G=5
- φ89 : G=4

● Mounting Clamp Code : B

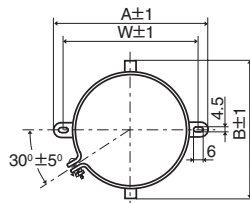

φD	A	B	W	F
50	78.0	64.0	68.0	22.4
63.5	90.0	76.0	80.0	28.0
76.2	104.5	90.0	93.5	31.5

● Mounting Clamp Code : C

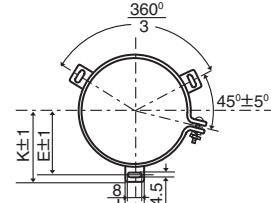

φD	E	K	F	J
50	32.5	37.0	22.4	14.0
63.5	38.1	43.5	28.0	14.0
76.2	44.5	50.0	31.5	14.0
89	50.8	56.5	31.5	16.0

<Screw specifications>

Plus hexagon-headed screw : M5×0.8×10

Maximum screw tightening torque : 3.23Nm

* The screw and the mounting clamp are separately supplied and not attached to the product.

◆ PART NUMBERING SYSTEM

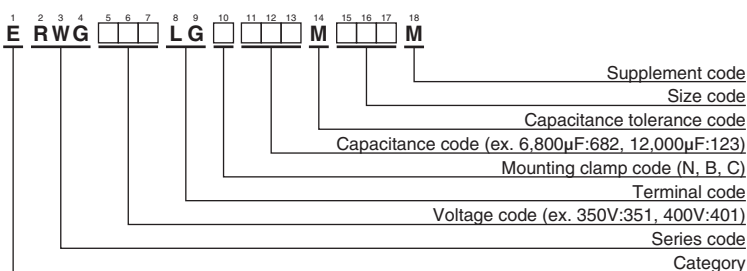

Please refer to "Product code guide (screw-mount terminal type)"

Return Group Chart



LARGE CAPACITANCE ALUMINUM ELECTROLYTIC CAPACITORS Inverter-use screw terminal, 85°C

RWG Series

◆STANDARD RATINGS

WV (V _{dc})	Cap (μF)	Case size φD×L(mm)	tan δ	Rated ripple current (Arms/85°C)		Part No.	WV (V _{dc})	Cap (μF)	Case size φD×L(mm)	tan δ	Rated ripple current (Arms/85°C)		Part No.	
				120Hz	300Hz						120Hz	300Hz		
350	2,200	50 × 96	0.25	7.70	9.20	ERWG351LGC222MC96M	400	6,800	63.5 × 190	0.25	20.6	24.7	ERWG401LGC682MDK0M	
	2,700	50 × 105	0.25	8.90	10.6	ERWG351LGC272MCA5M		6,800	76.2 × 130	0.25	19.2	23.0	ERWG401LGC682MED0M	
	3,300	50 × 115	0.25	10.3	12.3	ERWG351LGC332MCB5M		8,200	76.2 × 155	0.25	22.7	27.2	ERWG401LGC822MEF5M	
	3,900	50 × 130	0.25	11.8	14.1	ERWG351LGC392MCD0M		10,000	76.2 × 170	0.25	26.2	31.4	ERWG401LGC103MEH0M	
	4,700	63.5 × 115	0.25	13.6	16.3	ERWG351LGC472MDB5M		12,000	89 × 155	0.25	30.0	36.0	ERWG401LGC123MFF5M	
	5,600	63.5 × 130	0.25	15.7	18.8	ERWG351LGC562MDD0M		12,000	89 × 170	0.25	31.3	37.5	ERWG401LGC123MFH0M	
	6,800	63.5 × 155	0.25	18.8	22.5	ERWG351LGC682MDF5M		15,000	89 × 190	0.25	36.7	44.0	ERWG401LGC153MFK0M	
	6,800	76.2 × 115	0.25	18.2	21.8	ERWG351LGC682MEB5M		450	1,500	50 × 96	0.25	6.40	7.60	ERWG451LGC152MC96M
	8,200	63.5 × 190	0.25	22.6	27.1	ERWG351LGC822MDK0M			1,800	50 × 105	0.25	7.30	8.70	ERWG451LGC182MCA5M
	8,200	76.2 × 130	0.25	21.0	25.2	ERWG351LGC822MED0M			2,200	50 × 115	0.25	8.40	10.0	ERWG451LGC222MCB5M
	10,000	76.2 × 155	0.25	25.1	30.1	ERWG351LGC103MEF5M			2,700	50 × 130	0.25	9.80	11.7	ERWG451LGC272MCD0M
	12,000	76.2 × 170	0.25	28.7	34.4	ERWG351LGC123MEH0M			3,300	63.5 × 115	0.25	11.4	13.6	ERWG451LGC332MDB5M
	15,000	89 × 155	0.25	33.6	40.3	ERWG351LGC153MFF5M			3,900	63.5 × 130	0.25	13.1	15.7	ERWG451LGC392MDD0M
	15,000	89 × 170	0.25	35.0	42.0	ERWG351LGC153MFH0M			4,700	63.5 × 155	0.25	15.6	18.7	ERWG451LGC472MDF5M
18,000	89 × 190	0.25	40.3	48.3	ERWG351LGC183MFK0M	4,700	76.2 × 115		0.25	15.1	18.1	ERWG451LGC472MEB5M		
400	1,800	50 × 96	0.25	7.00	8.40	ERWG401LGC182MC96M	5,600		63.5 × 190	0.25	18.7	22.4	ERWG451LGC562MDK0M	
	2,200	50 × 105	0.25	8.10	9.70	ERWG401LGC222MCA5M	5,600		76.2 × 130	0.25	17.4	20.8	ERWG451LGC562MED0M	
	2,700	50 × 115	0.25	9.30	11.1	ERWG401LGC272MCB5M	6,800		76.2 × 155	0.25	20.7	24.8	ERWG451LGC682MEF5M	
	3,300	50 × 130	0.25	10.9	13.0	ERWG401LGC332MCD0M	8,200		76.2 × 170	0.25	23.7	28.4	ERWG451LGC822MEH0M	
	3,900	63.5 × 115	0.25	12.4	14.8	ERWG401LGC392MDB5M	10,000		89 × 155	0.25	27.4	32.8	ERWG451LGC103MFF5M	
	4,700	63.5 × 130	0.25	14.4	17.2	ERWG401LGC472MDD0M	10,000		89 × 170	0.25	28.6	34.3	ERWG451LGC103MFH0M	
	5,600	63.5 × 155	0.25	17.0	20.4	ERWG401LGC562MDF5M	12,000	89 × 190	0.25	32.9	39.4	ERWG451LGC123MFK0M		
	5,600	76.2 × 115	0.25	16.5	19.8	ERWG401LGC562MEB5M								

◆RATED RIPPLE CURRENT MULTIPLIERS

● Frequency Multipliers

Frequency (Hz)	50	120	300	1k	3k
Coefficient	0.8	1.0	1.2	1.4	1.5

Note : The endurance of capacitors is reduced with internal heating produced by ripple current at the rate of halving the lifetime with every 5 to 10°C rise. When long life performance is required in actual use, the rms ripple current has to be reduced. Also, for the RWG series capacitors, using them at operating voltage less than their rated voltage can extend their lifetime. For details, please contact a representative of Nippon Chemi-Con.

Return Group Chart



LARGE CAPACITANCE ALUMINUM ELECTROLYTIC CAPACITORS Inverter-use screw terminal, 85°C

RWF Series

- High ripple capability
- Endurance with ripple current : 5,000 hours at 85°C
- Wide range of case sizes from $\phi 50$ to $\phi 100$
- RoHS Compliant

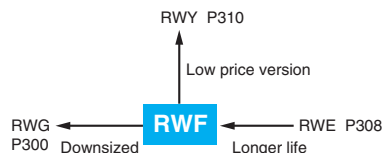

◆ SPECIFICATIONS

Items	Characteristics						
Category							
Temperature Range	-25 to +85°C						
Rated Voltage Range	350 to 450V _{dc}						
Capacitance Tolerance	±20% (M) (at 20°C, 120Hz)						
Leakage Current	I=0.02CV or 5mA, whichever is smaller. Where, I : Max. leakage current (μA), C : Nominal capacitance (μF), V : Rated voltage (V) (at 20°C after 5 minutes)						
Dissipation Factor (tan δ)	0.25 max. (at 20°C, 120Hz)						
Low Temperature Characteristics	Capacitance change $C(-25°C)/C(+20°C) \geq 0.7$ (at 120Hz)						
Insulation Resistance	When measured between the terminals that are connected to each other and to the mounting clamp on the insulating sleeve covering the case by using an insulation resistance meter of 500V _{dc} , the insulation resistance shall not be less than 100MΩ.						
Insulation Withstanding Voltage	When a voltage of 2,000V _{ac} is applied for 1 minute between the terminals that are connected to each other and to the mounting clamp on the insulating sleeve covering the case, there shall not be electrical damage.						
Endurance	The following specifications shall be satisfied when the capacitors are restored to 20°C after subjected to DC voltage with the rated ripple current is applied (the peak voltage shall not exceed the rated voltage) for 5,000 hours at 85°C. <table border="1"> <tr> <td>Capacitance change</td> <td>≤ ±20% of the initial value</td> </tr> <tr> <td>D.F. (tan δ)</td> <td>≤ 200% of the initial specified value</td> </tr> <tr> <td>Leakage current</td> <td>≤ The initial specified value</td> </tr> </table>	Capacitance change	≤ ±20% of the initial value	D.F. (tan δ)	≤ 200% of the initial specified value	Leakage current	≤ The initial specified value
Capacitance change	≤ ±20% of the initial value						
D.F. (tan δ)	≤ 200% of the initial specified value						
Leakage current	≤ The initial specified value						
Shelf Life	The following specifications shall be satisfied when the capacitors are restored to 20°C after exposing them for 500 hours at 85°C without voltage applied. Before the measurement, the capacitor shall be preconditioned by applying voltage according to Item 4.1 of JIS C 5101-4. <table border="1"> <tr> <td>Capacitance change</td> <td>≤ ±20% of the initial value</td> </tr> <tr> <td>D.F. (tan δ)</td> <td>≤ 200% of the initial specified value</td> </tr> <tr> <td>Leakage current</td> <td>≤ The initial specified value</td> </tr> </table>	Capacitance change	≤ ±20% of the initial value	D.F. (tan δ)	≤ 200% of the initial specified value	Leakage current	≤ The initial specified value
Capacitance change	≤ ±20% of the initial value						
D.F. (tan δ)	≤ 200% of the initial specified value						
Leakage current	≤ The initial specified value						

◆ DIMENSIONS (Screw-Mount) [mm]

● Terminal Code : LG

● Mounting Clamp Code : B

● Mounting Clamp Code : C

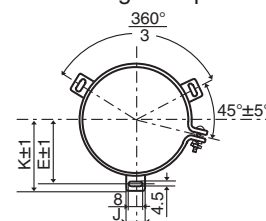
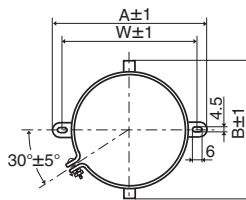
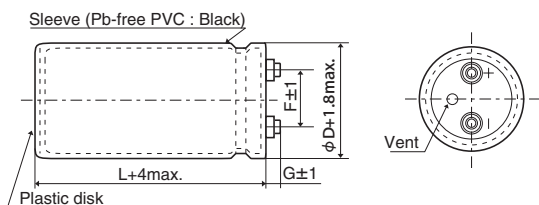

φD	A	B	W	F
50	78.0	64.0	68.0	22.4
63.5	90.0	76.0	80.0	28.0
76.2	104.5	90.0	93.5	31.5

φD	E	K	F	J
50	32.5	37.0	22.4	14.0
63.5	38.1	43.5	28.0	14.0
76.2	44.5	50.0	31.5	14.0
89	50.8	56.5	31.5	16.0
100	56.5	63.4	41.5	18.0

- φ50 & φ63.5 : G=6
- φ76.2 & φ89 : G=5
- φ100 : G=10

<Screw specifications>

to φ89 Plus hexagon-headed screw : M5×0.8×10
Maximum screw tightening torque : 3.23Nm

φ100 Cross-recessed head (Phillips) screw : M8×1.25×16
Spring washer, Washer
Maximum screw tightening torque : 6.31Nm

* The screw and the mounting clamp are separately supplied and not attached to the product.

◆ PART NUMBERING SYSTEM

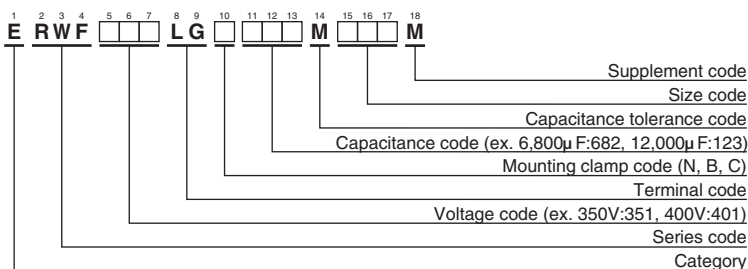

Please refer to "Product code guide (screw-mount terminal type)"

Return Group Chart



LARGE CAPACITANCE ALUMINUM ELECTROLYTIC CAPACITORS Inverter-use screw terminal, 85°C

RWF Series

◆STANDARD RATINGS

WV (V _{dc})	Cap (μF)	Case size φD×L(mm)	tan δ	Rated ripple current (Arms/85°C, 120Hz)	Part No.	WV (V _{dc})	Cap (μF)	Case size φD×L(mm)	tan δ	Rated ripple current (Arms/85°C, 120Hz)	Part No.	
350	1,200	50 × 60	0.25	4.90	ERWF351LGC122MC60M	400	5,600	63.5 × 190	0.25	18.2	ERWF401LGC562MDK0M	
	1,800	50 × 75	0.25	6.50	ERWF351LGC182MC75M		5,600	76.2 × 130	0.25	16.9	ERWF401LGC562MED0M	
	2,200	50 × 85	0.25	7.50	ERWF351LGC222MC85M		6,800	76.2 × 155	0.25	20.2	ERWF401LGC682MEF5M	
	2,200	50 × 96	0.25	7.70	ERWF351LGC222MC96M		8,200	76.2 × 170	0.25	22.8	ERWF401LGC822MEH0M	
	2,700	50 × 115	0.25	9.30	ERWF351LGC272MCB5M		10,000	89 × 155	0.25	26.6	ERWF401LGC103MFF5M	
	3,300	50 × 130	0.25	10.8	ERWF351LGC332MCD0M		12,000	89 × 170	0.25	30.0	ERWF401LGC123MFH0M	
	3,900	63.5 × 115	0.25	12.1	ERWF351LGC392MDB5M		15,000	100 × 190	0.25	33.7	ERWF401LGC153MGK0M	
	4,700	63.5 × 130	0.25	14.0	ERWF351LGC472MDD0M		18,000	100 × 220	0.25	37.4	ERWF401LGC183MGN0M	
	5,600	63.5 × 155	0.25	16.6	ERWF351LGC562MDF5M		450	820	50 × 60	0.25	4.00	ERWF451LGC821MC60M
	5,600	76.2 × 115	0.25	16.1	ERWF351LGC562MEB5M			1,000	50 × 75	0.25	4.80	ERWF451LGC102MC75M
	6,800	63.5 × 190	0.25	20.0	ERWF351LGC682MDK0M			1,200	50 × 85	0.25	5.60	ERWF451LGC122MC85M
	6,800	76.2 × 130	0.25	18.6	ERWF351LGC682MED0M			1,200	50 × 96	0.25	5.70	ERWF451LGC122MC96M
	8,200	76.2 × 155	0.25	22.2	ERWF351LGC822MEF5M			1,500	50 × 96	0.25	6.30	ERWF451LGC152MC96M
	10,000	76.2 × 170	0.25	25.2	ERWF351LGC103MEH0M			1,800	50 × 115	0.25	7.60	ERWF451LGC182MCB5M
	12,000	89 × 155	0.25	29.1	ERWF351LGC123MFF5M			2,200	50 × 130	0.25	8.80	ERWF451LGC222MCD0M
	15,000	89 × 190	0.25	35.7	ERWF351LGC153MFK0M			2,700	63.5 × 115	0.25	10.1	ERWF451LGC272MDB5M
18,000	100 × 190	0.25	36.9	ERWF351LGC183MGK0M	3,300	63.5 × 130		0.25	11.7	ERWF451LGC332MDD0M		
22,000	100 × 250	0.25	46.1	ERWF351LGC223MGR0M	3,900	63.5 × 155		0.25	13.8	ERWF451LGC392MDF5M		
400	1,000	50 × 60	0.25	4.40	ERWF401LGC102MC60M	3,900		76.2 × 115	0.25	13.4	ERWF451LGC392MEB5M	
	1,500	50 × 75	0.25	5.90	ERWF401LGC152MC75M	4,700		63.5 × 190	0.25	16.7	ERWF451LGC472MDK0M	
	1,800	50 × 85	0.25	6.80	ERWF401LGC182MC85M	4,700		76.2 × 130	0.25	15.5	ERWF451LGC472MED0M	
	1,800	50 × 96	0.25	7.00	ERWF401LGC182MC96M	5,600		76.2 × 155	0.25	18.3	ERWF451LGC562MEF5M	
	2,200	50 × 105	0.25	8.00	ERWF401LGC222MCA5M	6,800		76.2 × 170	0.25	20.7	ERWF451LGC682MEH0M	
	2,700	50 × 130	0.25	9.80	ERWF401LGC272MCD0M	8,200		89 × 155	0.25	24.1	ERWF451LGC822MFF5M	
	3,300	63.5 × 115	0.25	11.1	ERWF401LGC332MDB5M	10,000	89 × 170	0.25	27.8	ERWF451LGC103MFH0M		
	3,900	63.5 × 130	0.25	12.7	ERWF401LGC392MDD0M	12,000	100 × 190	0.25	29.3	ERWF451LGC123MGK0M		
	4,700	63.5 × 155	0.25	15.2	ERWF401LGC472MDF5M	15,000	100 × 250	0.25	37.0	ERWF451LGC153MGR0M		
	4,700	76.2 × 115	0.25	14.7	ERWF401LGC472MEB5M							

◆RATED RIPPLE CURRENT MULTIPLIERS

● Frequency Multipliers

Frequency (Hz)	50	120	300	1k	3k
Coefficient	0.8	1.0	1.1	1.3	1.4

Note : The endurance of capacitors is reduced with internal heating produced by ripple current at the rate of halving the lifetime with every 5 to 10°C rise. When long life performance is required in actual use, the rms ripple current has to be reduced. Also, for the RWF series capacitors, using them at operating voltage less than their rated voltage can extend their lifetime. For details, please contact a representative of Nippon Chemi-Con.

Return Group Chart



LARGE CAPACITANCE ALUMINUM ELECTROLYTIC CAPACITORS Inverter-use screw terminal, 85°C

RWR Series

- Downsized and high ripple current from RWQ series
- Endurance with ripple current : 2,000 hours at 85°C
- RoHS Compliant

RWR

↓
Downsized
RWQ P306



◆ SPECIFICATIONS

Items	Characteristics								
Category									
Temperature Range	-25 to +85°C								
Rated Voltage Range	350 to 450V _{dc}								
Capacitance Tolerance	±20% (M) (at 20°C, 120Hz)								
Leakage Current	I=0.02CV or 5mA, whichever is smaller. Where, I : Max. leakage current (μA), C : Nominal capacitance (μF), V : Rated voltage (V) (at 20°C after 5 minutes)								
Dissipation Factor (tan δ)	0.25 max. (at 20°C, 120Hz)								
Low Temperature Characteristics	Capacitance change $C(-25^{\circ}\text{C})/C(+20^{\circ}\text{C}) \geq 0.7$ (at 120Hz)								
Insulation Resistance	When measured between the terminals that are connected to each other and to the mounting clamp on the insulating sleeve covering the case by using an insulation resistance meter of 500V _{dc} , the insulation resistance shall not be less than 100MΩ.								
Insulation Withstanding Voltage	When a voltage of 2,000V _{ac} is applied for 1 minute between the terminals that are connected to each other and to the mounting clamp on the insulating sleeve covering the case, there shall not be electrical damage.								
Endurance	The following specifications shall be satisfied when the capacitors are restored to 20°C after subjected to DC voltage with the rated ripple current is applied (the peak voltage shall not exceed the rated voltage) for 2,000 hours at 85°C. <table border="1"> <tr> <td>Capacitance change</td> <td>≤ ±20% of the initial value</td> </tr> <tr> <td>D.F. (tan δ)</td> <td>≤ 300% of the initial specified value</td> </tr> <tr> <td>Leakage current</td> <td>≤ The initial specified value</td> </tr> </table>	Capacitance change	≤ ±20% of the initial value	D.F. (tan δ)	≤ 300% of the initial specified value	Leakage current	≤ The initial specified value		
Capacitance change	≤ ±20% of the initial value								
D.F. (tan δ)	≤ 300% of the initial specified value								
Leakage current	≤ The initial specified value								
Useful life	The following specifications shall be satisfied when the capacitors are restored to 20°C after subjected to DC voltage with the rated ripple current is applied (the peak voltage shall not exceed the rated voltage) for 5,000 hours at 85°C. <table border="1"> <tr> <td>Capacitance change</td> <td>≤ ±30% of the initial value</td> </tr> <tr> <td>D.F. (tan δ)</td> <td>≤ 300% of the initial specified value</td> </tr> <tr> <td>Leakage current</td> <td>≤ The initial specified value</td> </tr> <tr> <td>Failure rate</td> <td>≤ 1%</td> </tr> </table>	Capacitance change	≤ ±30% of the initial value	D.F. (tan δ)	≤ 300% of the initial specified value	Leakage current	≤ The initial specified value	Failure rate	≤ 1%
Capacitance change	≤ ±30% of the initial value								
D.F. (tan δ)	≤ 300% of the initial specified value								
Leakage current	≤ The initial specified value								
Failure rate	≤ 1%								
Shelf Life	The following specifications shall be satisfied when the capacitors are restored to 20°C after exposing them for 500 hours at 85°C without voltage applied. Before the measurement, the capacitor shall be preconditioned by applying voltage according to Item 4.1 of JIS C 5101-4. <table border="1"> <tr> <td>Capacitance change</td> <td>≤ ±20% of the initial value</td> </tr> <tr> <td>D.F. (tan δ)</td> <td>≤ 300% of the initial specified value</td> </tr> <tr> <td>Leakage current</td> <td>≤ The initial specified value</td> </tr> </table>	Capacitance change	≤ ±20% of the initial value	D.F. (tan δ)	≤ 300% of the initial specified value	Leakage current	≤ The initial specified value		
Capacitance change	≤ ±20% of the initial value								
D.F. (tan δ)	≤ 300% of the initial specified value								
Leakage current	≤ The initial specified value								

◆ DIMENSIONS (Screw-Mount) [mm]

● Terminal Code : LG

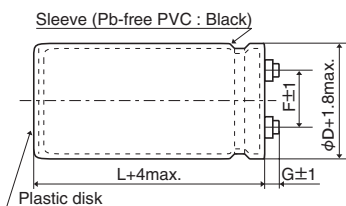

φ63.5, φ76.2 : G=6
φ89 : G=4

● Mounting Clamp Code : B

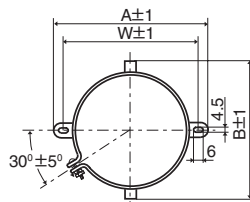

φD	A	B	W	F
63.5	90.0	76.0	80.0	28.0
76.2	104.5	90.0	93.5	31.5

● Mounting Clamp Code : C

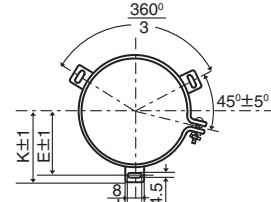

φD	E	K	F	J
63.5	38.1	43.5	28.0	14.0
76.2	44.5	50.0	31.5	14.0
89	50.8	56.5	31.5	16.0

<Screw specifications>

Plus hexagon-headed screw :M5×0.8×10

Maximum screw tightening torque :3.23Nm

* The screw and the mounting clamp are separately supplied and not attached to the product.

◆ PART NUMBERING SYSTEM

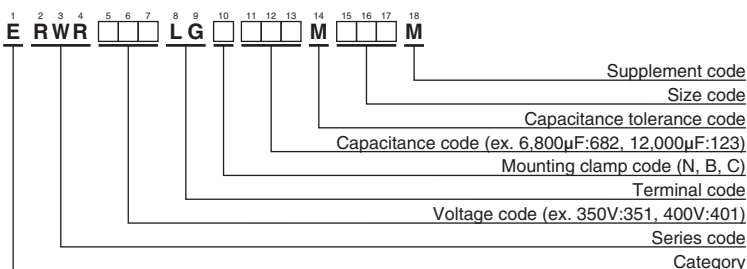

Please refer to "Product code guide (screw-mount terminal type)"

Return Group Chart



LARGE CAPACITANCE ALUMINUM ELECTROLYTIC CAPACITORS Inverter-use screw terminal, 85°C

RWR Series

◆STANDARD RATINGS

WV (V _{dc})	Cap (μF)	Case size φD×L(mm)	tan δ	Rated ripple current (Arms/85°C, 120Hz)	Part No.	WV (V _{dc})	Cap (μF)	Case size φD×L(mm)	tan δ	Rated ripple current (Arms/85°C, 120Hz)	Part No.	
350	3,900	63.5 × 100	0.25	13.7	ERWR351LGC392MDA0M	400	6,800	76.2 × 110	0.25	20.9	ERWR401LGC682MEB0M	
	4,700	63.5 × 100	0.25	15.1	ERWR351LGC472MDA0M		8,200	76.2 × 130	0.25	24.7	ERWR401LGC822MED0M	
	5,600	63.5 × 115	0.25	17.5	ERWR351LGC562MDB5M		10,000	89 × 125	0.25	26.4	ERWR401LGC103MFC5M	
	5,600	76.2 × 100	0.25	18.2	ERWR351LGC562MEA0M		12,000	89 × 145	0.25	30.8	ERWR401LGC123MFE5M	
	6,800	76.2 × 100	0.25	20.1	ERWR351LGC682MEA0M		450	2,700	63.5 × 100	0.25	11.4	ERWR451LGC272MDA0M
	8,200	76.2 × 115	0.25	23.4	ERWR351LGC822MEB5M			3,300	63.5 × 105	0.25	12.9	ERWR451LGC332MDA5M
	10,000	76.2 × 135	0.25	27.7	ERWR351LGC103MED5M			3,900	63.5 × 115	0.25	14.6	ERWR451LGC392MDB5M
	12,000	89 × 125	0.25	28.9	ERWR351LGC123MFC5M			3,900	76.2 × 100	0.25	15.2	ERWR451LGC392MEA0M
15,000	89 × 150	0.25	34.9	ERWR351LGC153MFF0M	4,700	63.5 × 135		0.25	17.2	ERWR451LGC472MDD5M		
400	3,300	63.5 × 100	0.25	12.6	ERWR401LGC332MDA0M	4,700		76.2 × 105	0.25	17.0	ERWR451LGC472MEA5M	
	3,900	63.5 × 100	0.25	13.7	ERWR401LGC392MDA0M	5,600		76.2 × 115	0.25	19.3	ERWR451LGC562MEB5M	
	4,700	63.5 × 115	0.25	16.0	ERWR401LGC472MDB5M	6,800		76.2 × 135	0.25	22.8	ERWR451LGC682MED5M	
	4,700	76.2 × 100	0.25	16.7	ERWR401LGC472MEA0M	8,200	89 × 125	0.25	23.9	ERWR451LGC822MFC5M		
	5,600	63.5 × 130	0.25	18.4	ERWR401LGC562MDD0M	10,000	89 × 150	0.25	28.5	ERWR451LGC103MFF0M		

◆RATED RIPPLE CURRENT MULTIPLIERS

●Frequency Multipliers

Frequency (Hz)	50	120	300	1k	3k
Coefficient	0.8	1.0	1.1	1.3	1.4

Note : The endurance of capacitors is reduced with internal heating produced by ripple current at the rate of halving the lifetime with every 5 to 10°C rise. When long life performance is required in actual use, the rms ripple current has to be reduced. Also, for the RWR series capacitors, using them at operating voltage less than their rated voltage can extend their lifetime. For details, please contact a representative of Nippon Chemi-Con.

◆USEFUL LIFE

Useful life depending on the ambient temperature Tx under ripple current operating conditions

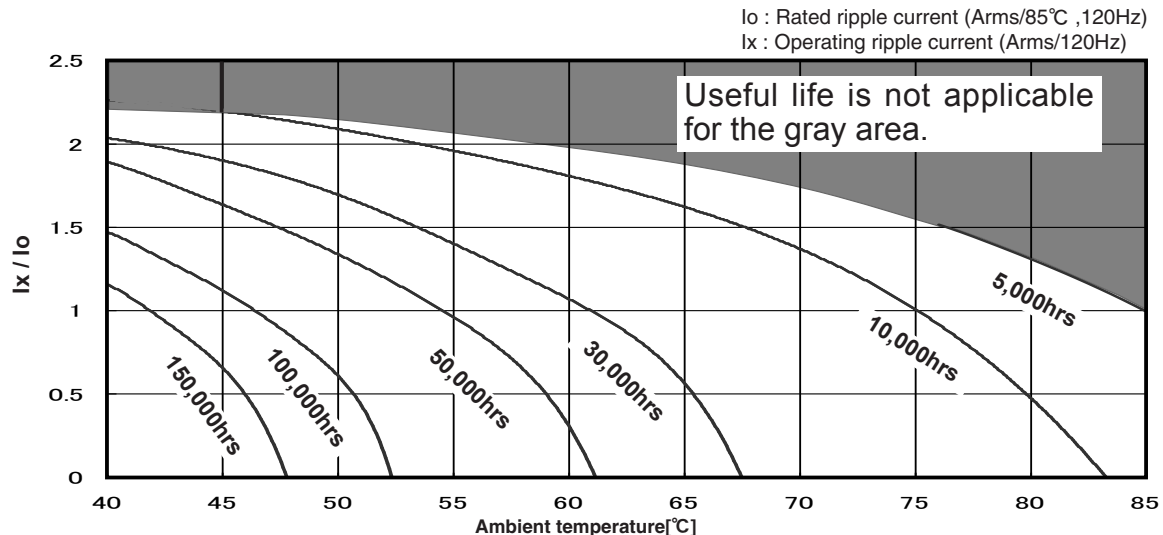

◆Warning !

Useful life shall indicate the end of the life time without exceeding the specified failure rate. It's generally known that Aluminum Electrolytic Capacitors have wear-out failure mode with gradual deterioration of the electrical parameters and should have large number of the failure rate at the end of life. The useful life time is specified by a certain failure rate. It's not a guaranteed specification.

Generally the maximum life time is 15 years (131,000hours) considering sealing material deteriorate. When a longer life time is required for your application, please consult us.

Return Group Chart



LARGE CAPACITANCE ALUMINUM ELECTROLYTIC CAPACITORS Inverter-use screw terminal, 85°C

RWQ Series

- Downsized and high ripple current from RWE series
- Endurance with ripple current : 2,000 hours at 85°C
- RoHS Compliant

RWQ

↓
Downsized

RWE P308



◆ SPECIFICATIONS

Items	Characteristics		
Category	-25 to +85°C		
Temperature Range	-25 to +85°C		
Rated Voltage Range	350 to 550V _{dc}		
Capacitance Tolerance	±20% (M) (at 20°C, 120Hz)		
Leakage Current	I=0.02CV or 5mA, whichever is smaller. Where, I : Max. leakage current (μA), C : Nominal capacitance (μF), V : Rated voltage (V _{dc}) (at 20°C after 5 minutes)		
Dissipation Factor (tan δ)	0.25 max. (at 20°C, 120Hz)		
Low Temperature Characteristics	Rated voltage (V _{dc})	350 to 450V	500 to 550V
	C(-25°C) / C(+20°C)	≥0.7	≥0.6
Insulation Resistance	When measured between the terminals shorted each other and the mounting clamp on the insulating sleeve covering the case by using an insulation resistance meter of 500V _{dc} , the insulation resistance shall not be less than 100MΩ.		
Insulation Withstanding Voltage	When a voltage of 2,000V _{ac} is applied for 1 minute between the terminals shorted each other and the mounting clamp on the insulating sleeve covering the case, there shall not be electrical damage.		
Endurance	The following specifications shall be satisfied when the capacitors are restored to 20°C after subjected to DC voltage with the rated ripple current is applied (the peak voltage shall not exceed the rated voltage) for 2,000 hours at 85°C.		
	Capacitance change	≤ ±20% of the initial value	
	D.F. (tan δ)	≤300% of the initial specified value	
	Leakage current	≤ The initial specified value	
Shelf Life	The following specifications shall be satisfied when the capacitors are restored to 20°C after exposing them for 500 hours at 85°C without voltage applied. Before the measurement, the capacitor shall be preconditioned by applying voltage according to Item 4.1 of JISC 5101-4.		
	Capacitance change	≤ ±20% of the initial value	
	D.F. (tan δ)	≤300% of the initial specified value	
	Leakage current	≤ The initial specified value	

◆ DIMENSIONS (Screw-Mount) [mm]

- Terminal Code : LG

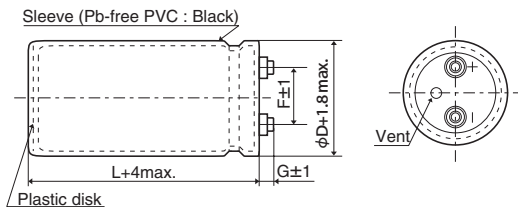

φ50 & φ63.5 : G=6
φ76.2 & φ89 : G=5

- Mounting Clamp Code : B

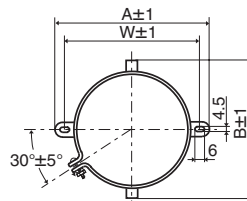

φD	A	B	W	F
50	78.0	64.0	68.0	22.4
63.5	90.0	76.0	80.0	28.0
76.2	104.5	90.0	93.5	31.5

- Mounting Clamp Code : C

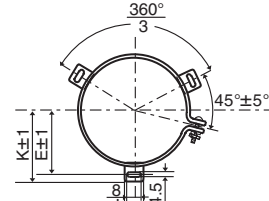

φD	E	K	F	J
50	32.5	37.0	22.4	14.0
63.5	38.1	43.5	28.0	14.0
76.2	44.5	50.0	31.5	14.0
89	50.8	56.5	31.5	16.0

<Screw specifications>

Plus hexagon-headed screw : M5×0.8×10

Maximum screw tightening torque : 3.23Nm

* The screw and the mounting clamp are separately supplied and not attached to the product.

◆ PART NUMBERING SYSTEM

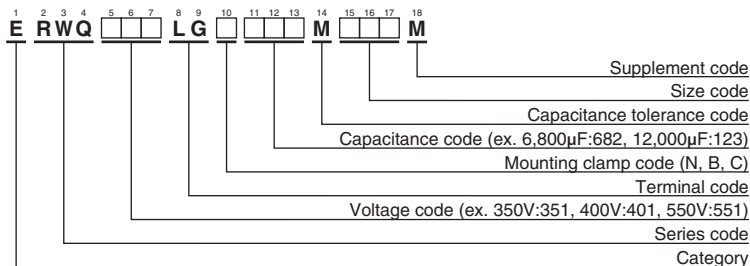

Please refer to "Product code guide (screw-mount terminal type)"

Return Group Chart



LARGE CAPACITANCE ALUMINUM ELECTROLYTIC CAPACITORS Inverter-use screw terminal, 85°C

RWQSeries

◆STANDARD RATINGS

WV (V _{dc})	Cap (μF)	Case size φD×L(mm)	tan δ	Rated ripple current (Arms/85°C, 120Hz)	Part No.	WV (V _{dc})	Cap (μF)	Case size φD×L(mm)	tan δ	Rated ripple current (Arms/85°C, 120Hz)	Part No.
350	1,500	50 × 65	0.25	5.09	ERWQ351LGC152MC65M	500	470	50 × 60	0.25	2.17	ERWQ501LGC471MC60M
	1,800	50 × 75	0.25	5.93	ERWQ351LGC182MC75M		680	50 × 65	0.25	2.70	ERWQ501LGC681MC65M
	2,200	50 × 96	0.25	7.30	ERWQ351LGC222MC96M		820	50 × 75	0.25	3.15	ERWQ501LGC821MC75M
	2,700	50 × 115	0.25	8.76	ERWQ351LGC272MCB5M		1,000	50 × 85	0.25	3.67	ERWQ501LGC102MC85M
	3,300	63.5 × 85	0.25	9.71	ERWQ351LGC332MD85M		1,200	50 × 96	0.25	4.22	ERWQ501LGC122MC96M
	3,900	50 × 130	0.25	11.1	ERWQ351LGC392MCD0M		1,500	50 × 115	0.25	5.14	ERWQ501LGC152MCB5M
	3,900	63.5 × 96	0.25	11.1	ERWQ351LGC392MD96M		1,500	63.5 × 96	0.25	5.42	ERWQ501LGC152MD96M
	4,700	63.5 × 115	0.25	13.2	ERWQ351LGC472MDB5M		1,800	50 × 130	0.25	5.95	ERWQ501LGC182MCD0M
	5,600	63.5 × 130	0.25	15.2	ERWQ351LGC562MDD0M		1,800	63.5 × 96	0.25	5.94	ERWQ501LGC182MD96M
	5,600	76.2 × 96	0.25	14.3	ERWQ351LGC562ME96M		2,200	63.5 × 115	0.25	7.10	ERWQ501LGC222MDB5M
	6,800	76.2 × 115	0.25	17.0	ERWQ351LGC682MEB5M		2,200	76.2 × 96	0.25	7.30	ERWQ501LGC222ME96M
	8,200	76.2 × 130	0.25	19.6	ERWQ351LGC822MED0M		2,700	63.5 × 130	0.25	8.31	ERWQ501LGC272MDD0M
	10,000	76.2 × 155	0.25	23.4	ERWQ351LGC103MEF5M		3,300	76.2 × 115	0.25	9.65	ERWQ501LGC332MEB5M
12,000	89 × 130	0.25	24.1	ERWQ351LGC123MFD0M	3,900	76.2 × 130	0.25	11.1	ERWQ501LGC392MED0M		
15,000	89 × 155	0.25	29.1	ERWQ351LGC153MFF5M	4,700	76.2 × 155	0.25	13.1	ERWQ501LGC472MEF5M		
400	1,200	50 × 65	0.25	4.55	ERWQ401LGC122MC65M	550	390	50 × 60	0.25	1.98	ERWQ551LGC391MC60M
	1,500	50 × 75	0.25	5.41	ERWQ401LGC152MC75M		560	50 × 65	0.25	2.45	ERWQ551LGC561MC65M
	1,800	50 × 85	0.25	6.26	ERWQ401LGC182MC85M		680	50 × 75	0.25	2.87	ERWQ551LGC681MC75M
	2,200	50 × 96	0.25	7.30	ERWQ401LGC222MC96M		820	50 × 85	0.25	3.32	ERWQ551LGC821MC85M
	2,700	50 × 115	0.25	8.76	ERWQ401LGC272MCB5M		1,200	50 × 115	0.25	4.60	ERWQ551LGC122MCB5M
	3,300	63.5 × 96	0.25	10.2	ERWQ401LGC332MD96M		1,500	63.5 × 96	0.25	5.42	ERWQ551LGC152MD96M
	3,900	63.5 × 115	0.25	12.0	ERWQ401LGC392MDB5M		1,800	76.2 × 80	0.25	6.12	ERWQ551LGC182ME80M
	4,700	63.5 × 130	0.25	13.9	ERWQ401LGC472MDD0M		2,200	76.2 × 96	0.25	7.30	ERWQ551LGC222ME96M
	4,700	76.2 × 96	0.25	13.1	ERWQ401LGC472ME96M		2,700	76.2 × 115	0.25	8.73	ERWQ551LGC272MEB5M
	5,600	63.5 × 155	0.25	16.5	ERWQ401LGC562MDF5M		3,300	76.2 × 130	0.25	10.2	ERWQ551LGC332MED0M
	6,800	76.2 × 115	0.25	17.0	ERWQ401LGC682MEB5M		5,600	89 × 155	0.25	14.5	ERWQ551LGC562MFF5M
	8,200	76.2 × 155	0.25	21.2	ERWQ401LGC822MEF5M						
	10,000	89 × 130	0.25	22.0	ERWQ401LGC103MFD0M						
12,000	89 × 155	0.25	26.0	ERWQ401LGC123MFF5M							
450	1,000	50 × 70	0.25	3.87	ERWQ451LGC102MC70M						
	1,200	50 × 75	0.25	4.36	ERWQ451LGC122MC75M						
	1,500	50 × 90	0.25	5.28	ERWQ451LGC152MC90M						
	1,800	50 × 96	0.25	5.95	ERWQ451LGC182MC96M						
	2,200	50 × 130	0.25	7.54	ERWQ451LGC222MCD0M						
	2,700	63.5 × 96	0.25	8.34	ERWQ451LGC272MD96M						
	3,300	63.5 × 115	0.25	9.97	ERWQ451LGC332MDB5M						
	3,900	63.5 × 130	0.25	11.4	ERWQ451LGC392MDD0M						
	3,900	76.2 × 96	0.25	11.1	ERWQ451LGC392ME96M						
	4,700	63.5 × 155	0.25	13.6	ERWQ451LGC472MDF5M						
	4,700	76.2 × 115	0.25	13.2	ERWQ451LGC472MEB5M						
	5,600	76.2 × 130	0.25	15.2	ERWQ451LGC562MED0M						
	6,800	76.2 × 155	0.25	18.1	ERWQ451LGC682MEF5M						
8,200	89 × 130	0.25	19.2	ERWQ451LGC822MFD0M							

◆RATED RIPPLE CURRENT MULTIPLIERS

●Frequency Multipliers

Frequency (Hz)	50	120	300	1k	3k
Coefficient	0.8	1.0	1.1	1.3	1.4

Note : The endurance of capacitors is shorted with internal heating produced by ripple current at the rate of halving the lifetime with every 5 to 10°C rise. When long life performance is required in actual use, the rms ripple current has to be reduced. Also, for the RWQ series capacitors, using them at operating voltage less than their rated voltage can extend their lifetime. For the details, please contact a representative of Nippon Chemi-Con.

Return Group Chart



LARGE CAPACITANCE ALUMINUM ELECTROLYTIC CAPACITORS Inverter-use screw terminal, 85°C

RWE Series

- Rated voltage range : 350 to 550V_{dc}
- Endurance with ripple current : 85°C 2,000 hours
- RoHS Compliant

RWF P302
↑
Longer life
RWE



◆ SPECIFICATIONS

Items	Characteristics			
Category	-25 to +85°C			
Temperature Range	-25 to +85°C			
Rated Voltage Range	350 to 550V _{dc}			
Capacitance Tolerance	±20% (M)			(at 20°C, 120Hz)
Leakage Current	I=0.02CV or 5mA, whichever is smaller. Where, I : Max. leakage current (μA), C : Nominal capacitance (μF), V : Rated voltage (V) (at 20°C after 5 minutes)			
Dissipation Factor (tan δ)	0.25 max.			(at 20°C, 120Hz)
Low Temperature Characteristics	Capacitance change	Rated Voltage (V _{dc})	350 to 450V	500 & 550V
		C(-25°C)/C(+20°C)	≥0.7	≥0.6
Insulation Resistance	When measured between the terminals that are connected to each other and to the mounting clamp on the insulating sleeve covering the case by using an insulation resistance meter of 500V _{dc} , the insulation resistance shall not be less than 100MΩ.			
Insulation Withstanding Voltage	When a voltage of 2,000V _{ac} is applied for 1 minute between the terminals that are connected to each other and to the mounting clamp on the insulating sleeve covering the case, there shall not be electrical damage.			
Endurance	The following specifications shall be satisfied when the capacitors are restored to 20°C after subjected to DC voltage with the rated ripple current is applied (the peak voltage shall not exceed the rated voltage) for 2,000 hours at 85°C.			
	Capacitance change	≤ ±20% of the initial value		
	D.F. (tan δ)	≤ 300% of the initial specified value		
	Leakage current	≤ The initial specified value		
Shelf Life	The following specifications shall be satisfied when the capacitors are restored to 20°C after exposing them for 500 hours at 85°C without voltage applied. Before the measurement, the capacitor shall be preconditioned by applying voltage according to Item 4.1 of JIS C 5101-4.			
	Capacitance change	≤ ±20% of the initial value		
	D.F. (tan δ)	≤ 300% of the initial specified value		
	Leakage current	≤ The initial specified value		

◆ DIMENSIONS (Screw-Mount) [mm]

● Terminal Code : LG

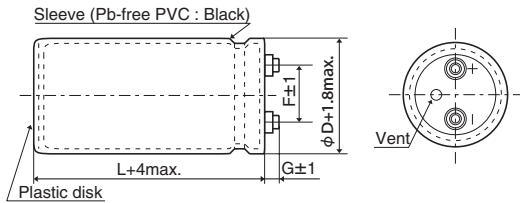

φ35 to φ63.5 : G=6
φ76.2 & φ89 : G=5

<Screw specifications>

Plus hexagon-headed screw : M5×0.8×10
Maximum screw tightening torque : 3.23Nm

* The screw and the mounting clamp are separately supplied and not attached to the product.

● Mounting Clamp Code : B

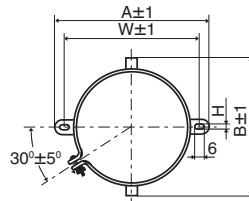

φD	A	B	W	H	F
35	58.0	44.0	48.0	3.5	12.7
50	78.0	64.0	68.0	4.5	22.4
63.5	90.0	76.0	80.0	4.5	28.0
76.2	104.5	90.0	93.5	4.5	31.5

● Mounting Clamp Code : C

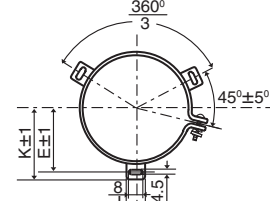

φD	E	K	F	J
50	32.5	37.0	22.4	14.0
63.5	38.1	43.5	28.0	14.0
76.2	44.5	50.0	31.5	14.0
89	50.8	56.5	31.5	16.0

◆ PART NUMBERING SYSTEM

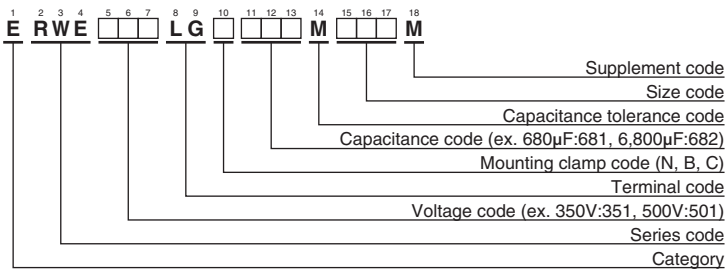

Please refer to "Product code guide (screw-mount terminal type)"

Return Group Chart



LARGE CAPACITANCE ALUMINUM ELECTROLYTIC CAPACITORS Inverter-use screw terminal, 85°C

RWE Series

◆STANDARD RATINGS

WV (V _{dc})	Cap (μF)	Case size φD×L(mm)	tan δ	Rated ripple current (Arms/85°C, 120Hz)	Part No.	WV (V _{dc})	Cap (μF)	Case size φD×L(mm)	tan δ	Rated ripple current (Arms/85°C, 120Hz)	Part No.	
350	390	35 × 50	0.25	1.90	ERWE351LGB391MA50M	450	2,700	63.5 × 115	0.25	8.60	ERWE451LGC272MDB5M	
	680	35 × 80	0.25	2.90	ERWE351LGB681MA80M		3,300	63.5 × 130	0.25	10.0	ERWE451LGC332MDD0M	
	1,000	35 × 100	0.25	3.80	ERWE351LGB102MAA0M		3,300	76.2 × 96	0.25	9.80	ERWE451LGC332ME96M	
	1,200	35 × 120	0.25	4.20	ERWE351LGB122MAC0M		3,900	76.2 × 115	0.25	11.5	ERWE451LGC392MEB5M	
	1,500	50 × 75	0.25	4.70	ERWE351LGC152MC75M		4,700	76.2 × 130	0.25	13.3	ERWE451LGC472MED0M	
	2,200	50 × 96	0.25	6.30	ERWE351LGC222MC96M		5,600	76.2 × 155	0.25	15.7	ERWE451LGC562MEF5M	
	3,300	50 × 130	0.25	8.80	ERWE351LGC332MCD0M		8,200	89 × 155	0.25	18.6	ERWE451LGC822MFF5M	
	3,300	63.5 × 96	0.25	8.80	ERWE351LGC332MD96M		500	120	35 × 50	0.25	0.70	ERWE501LGB121MA50M
	3,900	63.5 × 115	0.25	10.3	ERWE351LGC392MDB5M			270	35 × 80	0.25	1.20	ERWE501LGB271MA80M
	4,700	63.5 × 130	0.25	12.0	ERWE351LGC472MDD0M			330	35 × 100	0.25	1.40	ERWE501LGB331MAA0M
	4,700	76.2 × 96	0.25	11.7	ERWE351LGC472ME96M			390	35 × 120	0.25	1.70	ERWE501LGB391MAC0M
	5,600	76.2 × 115	0.25	12.6	ERWE351LGC562MEB5M			470	50 × 75	0.25	1.80	ERWE501LGC471MC75M
	6,800	76.2 × 130	0.25	15.9	ERWE351LGC682MED0M			680	50 × 96	0.25	2.50	ERWE501LGC681MC96M
	8,200	76.2 × 155	0.25	19.0	ERWE351LGC822MEF5M			820	50 × 115	0.25	2.90	ERWE501LGC821MCB5M
12,000	89 × 155	0.25	22.5	ERWE351LGC123MFF5M	1,000	50 × 130		0.25	3.40	ERWE501LGC102MCD0M		
400	330	35 × 50	0.25	1.70	ERWE401LGB331MA50M	1,000		63.5 × 96	0.25	3.40	ERWE501LGC102MD96M	
	560	35 × 80	0.25	2.70	ERWE401LGB561MA80M	1,500		63.5 × 115	0.25	4.50	ERWE501LGC152MDB5M	
	820	35 × 100	0.25	3.40	ERWE401LGB821MAA0M	1,500		76.2 × 96	0.25	4.60	ERWE501LGC152ME96M	
	1,000	35 × 120	0.25	3.90	ERWE401LGB102MAC0M	1,800		63.5 × 130	0.25	5.20	ERWE501LGC182MDD0M	
	1,200	50 × 75	0.25	4.20	ERWE401LGC122MC75M	2,200		76.2 × 115	0.25	6.10	ERWE501LGC222MEB5M	
	1,800	50 × 96	0.25	5.70	ERWE401LGC182MC96M	2,700		76.2 × 155	0.25	7.70	ERWE501LGC272MEF5M	
	2,200	50 × 130	0.25	7.20	ERWE401LGC222MCD0M	3,900	89 × 155	0.25	10.1	ERWE501LGC392MFF5M		
	2,700	63.5 × 96	0.25	7.90	ERWE401LGC272MD96M	550	100	35 × 50	0.25	0.60	ERWE551LGB101MA50M	
	3,300	63.5 × 115	0.25	9.50	ERWE401LGC332MDB5M		180	35 × 80	0.25	1.00	ERWE551LGB181MA80M	
	3,900	63.5 × 130	0.25	10.9	ERWE401LGC392MDD0M		270	35 × 100	0.25	1.30	ERWE551LGB271MAA0M	
	3,900	76.2 × 96	0.25	10.6	ERWE401LGC392ME96M		330	35 × 120	0.25	1.60	ERWE551LGB331MAC0M	
	4,700	76.2 × 115	0.25	12.6	ERWE401LGC472MEB5M		390	50 × 75	0.25	1.70	ERWE551LGC391MC75M	
	5,600	76.2 × 130	0.25	14.5	ERWE401LGC562MED0M		560	50 × 96	0.25	2.10	ERWE551LGC561MC96M	
	6,800	76.2 × 155	0.25	17.3	ERWE401LGC682MEF5M		560	63.5 × 96	0.25	2.50	ERWE551LGC561MD96M	
10,000	89 × 155	0.25	20.5	ERWE401LGC103MFF5M	680		50 × 115	0.25	2.70	ERWE551LGC681MCB5M		
450	270	35 × 50	0.25	1.60	ERWE451LGB271MA50M		680	63.5 × 115	0.25	3.00	ERWE551LGC681MDB5M	
	470	35 × 80	0.25	2.40	ERWE451LGB471MA80M		820	50 × 130	0.25	3.10	ERWE551LGC821MCD0M	
	680	35 × 100	0.25	3.10	ERWE451LGB681MAA0M		820	63.5 × 130	0.25	3.50	ERWE551LGC821MDD0M	
	820	35 × 120	0.25	3.50	ERWE451LGB821MAC0M		1,200	76.2 × 96	0.25	4.20	ERWE551LGC122ME96M	
	1,000	50 × 75	0.25	3.90	ERWE451LGC102MC75M		1,500	76.2 × 115	0.25	5.00	ERWE551LGC152MEB5M	
	1,200	50 × 96	0.25	4.70	ERWE451LGC122MC96M		1,800	76.2 × 130	0.25	5.80	ERWE551LGC182MED0M	
	1,500	50 × 115	0.25	5.60	ERWE451LGC152MCB5M	2,200	76.2 × 155	0.25	7.00	ERWE551LGC222MEF5M		
	1,800	50 × 130	0.25	6.50	ERWE451LGC182MCD0M	3,300	89 × 155	0.25	9.30	ERWE551LGC332MFF5M		
	2,200	63.5 × 96	0.25	7.20	ERWE451LGC222MD96M							

◆RATED RIPPLE CURRENT MULTIPLIERS

● Frequency Multipliers

Frequency (Hz)	50	120	300	1k	3k
Coefficient	0.8	1.0	1.1	1.3	1.4

Note : The endurance of capacitors is reduced with internal heating produced by ripple current at the rate of halving the lifetime with every 5 to 10°C rise. When long life performance is required in actual use, the rms ripple current has to be reduced. Also, for the RWE series capacitors, using them at operating voltage less than their rated voltage can extend their lifetime. For details, please contact a representative of Nippon Chemi-Con.

Return Group Chart



LARGE CAPACITANCE ALUMINUM ELECTROLYTIC CAPACITORS Inverter-use screw terminal, 85°C

RWY Series

- High ripple capability
- Endurance with ripple current : 5,000 hours at 85°C
- Reduced cost design for three-phase input inverters
- RoHS Compliant

RWY

Low price version

RWF P302



◆ SPECIFICATIONS

Items	Characteristics						
Category							
Temperature Range	-25 to +85°C						
Rated Voltage Range	350 to 450V _{dc}						
Capacitance Tolerance	±20% (M) (at 20°C, 120Hz)						
Leakage Current	I=0.02CV or 5mA, whichever is smaller. Where, I : Max. leakage current (μA), C : Nominal capacitance (μF), V : Rated voltage (V) (at 20°C after 5 minutes)						
Dissipation Factor (tan δ)	0.12 max. (at 20°C, 120Hz)						
Low Temperature Characteristics	Capacitance change $C(-25°C)/C(+20°C) \geq 0.7$ (at 120Hz)						
Insulation Resistance	When it is measured between the terminals that are connected to each other and to the mounting clamp on the insulating sleeve covering the case by using an insulation resistance meter of 500V _{dc} , the insulation resistance shall not be less than 100MΩ.						
Insulation Withstanding Voltage	When a voltage of 2,000V _{ac} is applied for 1 minute between the terminals that are connected to each other and to the mounting clamp on the insulating sleeve covering the case, there shall not be electrical damage.						
Endurance	The following specifications shall be satisfied when the capacitors are restored to 20°C after subjected to DC voltage with the rated ripple current is applied (the peak voltage shall not exceed the rated voltage) for 5,000 hours at 85°C. <table border="1" style="width:100%; border-collapse: collapse;"> <tr> <td>Capacitance change</td> <td>≤ ±20% of the initial value</td> </tr> <tr> <td>D.F. (tan δ)</td> <td>≤ 200% of the initial specified value</td> </tr> <tr> <td>Leakage current</td> <td>≤ The initial specified value</td> </tr> </table>	Capacitance change	≤ ±20% of the initial value	D.F. (tan δ)	≤ 200% of the initial specified value	Leakage current	≤ The initial specified value
Capacitance change	≤ ±20% of the initial value						
D.F. (tan δ)	≤ 200% of the initial specified value						
Leakage current	≤ The initial specified value						
Shelf Life	The following specifications shall be satisfied when the capacitors are restored to 20°C after exposing them for 1,000 hours at 85°C without voltage applied. Before the measurement, the capacitor shall be preconditioned by applying voltage according to Item 4.1 of JIS C 5101-4. <table border="1" style="width:100%; border-collapse: collapse;"> <tr> <td>Capacitance change</td> <td>≤ ±20% of the initial value</td> </tr> <tr> <td>D.F. (tan δ)</td> <td>≤ 200% of the initial specified value</td> </tr> <tr> <td>Leakage current</td> <td>≤ The initial specified value</td> </tr> </table>	Capacitance change	≤ ±20% of the initial value	D.F. (tan δ)	≤ 200% of the initial specified value	Leakage current	≤ The initial specified value
Capacitance change	≤ ±20% of the initial value						
D.F. (tan δ)	≤ 200% of the initial specified value						
Leakage current	≤ The initial specified value						

◆ DIMENSIONS (Screw-Mount) [mm]

● Terminal Code : LG

● Mounting Clamp Code : B

● Mounting Clamp Code : C

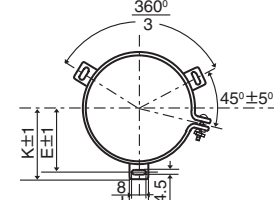
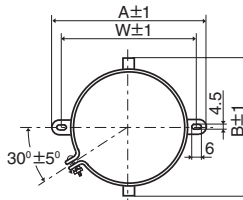
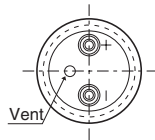
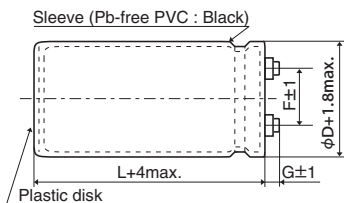

φ50 to φ76.2 : G=6
 φ89 : G=4
 φ100 : G=10

φD	A	B	W	F
50	78.0	64.0	68.0	22.4
63.5	90.0	76.0	80.0	28.0
76.2	104.5	90.0	93.5	31.5

φD	E	K	F	J
50	32.5	37.0	22.4	14.0
63.5	38.1	43.5	28.0	14.0
76.2	44.5	50.0	31.5	14.0
89	50.8	56.5	31.5	16.0
100	56.5	63.4	41.5	18.0

<Screw specifications>

to φ89 Plus hexagon-headed screw : M5×0.8×10
 Maximum screw tightening torque : 3.23Nm

φ100 Cross-recessed head (phillips) screw : M8×1.25×16
 Spring washer, Washer
 Maximum screw tightening torque : 6.31Nm

* The screw and the mounting clamp are separately supplied and not attached to the product.

◆ PART NUMBERING SYSTEM

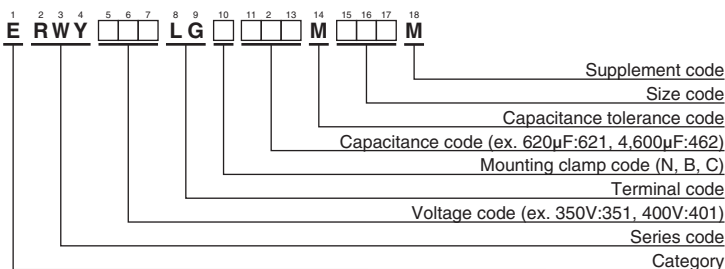

Please refer to "Product code guide (screw-mount terminal type)"

Return Group Chart



LARGE CAPACITANCE ALUMINUM ELECTROLYTIC CAPACITORS Inverter-use screw terminal, 85°C

RWY Series

◆STANDARD RATINGS

WV (V _{dc})	Cap (μF)	Case size φD×L(mm)	tan δ	Rated ripple current (Arms/85°C, 300Hz)	Part No.	WV (V _{dc})	Cap (μF)	Case size φD×L(mm)	tan δ	Rated ripple current (Arms/85°C, 300Hz)	Part No.	
350	750	50 × 75	0.12	5.10	ERWY351LGC751MC75M	400	3,200	63.5 × 170	0.12	17.3	ERWY401LGC322MDH0M	
	1,100	50 × 96	0.12	6.90	ERWY351LGC112MC96M		3,400	76.2 × 130	0.12	17.5	ERWY401LGC342MED0M	
	1,300	50 × 105	0.12	7.80	ERWY351LGC132MCA5M		4,200	76.2 × 155	0.12	21.1	ERWY401LGC422MEF5M	
	1,600	50 × 130	0.12	9.50	ERWY351LGC162MCD0M		4,600	76.2 × 170	0.12	23.0	ERWY401LGC462MEH0M	
	1,800	63.5 × 96	0.12	10.0	ERWY351LGC182MD96M		5,700	89 × 155	0.12	24.7	ERWY401LGC572MFF5M	
	1,900	50 × 145	0.12	10.7	ERWY351LGC192MCE5M		6,400	89 × 170	0.12	27.0	ERWY401LGC642MFH0M	
	2,400	63.5 × 115	0.12	12.6	ERWY351LGC242MDB5M		7,000	89 × 190	0.12	30.0	ERWY401LGC702MFK0M	
	2,800	63.5 × 130	0.12	14.3	ERWY351LGC282MDD0M		7,900	100 × 190	0.12	34.0	ERWY401LGC792MGK0M	
	3,400	63.5 × 155	0.12	17.1	ERWY351LGC342MDF5M		9,400	100 × 220	0.12	39.6	ERWY401LGC942MGN0M	
	3,500	76.2 × 115	0.12	16.9	ERWY351LGC352MEB5M		12,000	100 × 270	0.12	49.2	ERWY401LGC123MGT0M	
	3,800	63.5 × 170	0.12	18.8	ERWY351LGC382MDH0M		450	500	50 × 75	0.12	4.00	ERWY451LGC501MC75M
	4,000	76.2 × 130	0.12	19.0	ERWY351LGC402MED0M			710	50 × 96	0.12	5.20	ERWY451LGC711MC96M
	5,000	76.2 × 155	0.12	23.0	ERWY351LGC502MEF5M			840	50 × 105	0.12	5.90	ERWY451LGC841MCA5M
	5,600	76.2 × 170	0.12	25.3	ERWY351LGC562MEH0M			1,100	50 × 130	0.12	7.50	ERWY451LGC112MCD0M
	6,900	89 × 155	0.12	27.2	ERWY351LGC692MFF5M			1,200	63.5 × 96	0.12	7.80	ERWY451LGC122MD96M
	7,700	89 × 170	0.12	29.6	ERWY351LGC772MFH0M			1,300	50 × 145	0.12	8.40	ERWY451LGC132MCE5M
8,400	89 × 190	0.12	32.9	ERWY351LGC842MFK0M	1,600	63.5 × 115		0.12	9.80	ERWY451LGC162MDB5M		
9,500	100 × 190	0.12	37.3	ERWY351LGC952MGK0M	1,800	63.5 × 130		0.12	10.9	ERWY451LGC182MDD0M		
11,000	100 × 220	0.12	42.9	ERWY351LGC113MGN0M	2,300	63.5 × 155		0.12	13.3	ERWY451LGC232MDF5M		
14,000	100 × 270	0.12	53.1	ERWY351LGC143MGT0M	2,300	76.2 × 115		0.12	13.0	ERWY451LGC232MEB5M		
400	620	50 × 75	0.12	4.60	ERWY401LGC621MC75M	2,500		63.5 × 170	0.12	14.5	ERWY451LGC252MDH0M	
	880	50 × 96	0.12	6.10	ERWY401LGC881MC96M	2,700		76.2 × 130	0.12	14.8	ERWY451LGC272MED0M	
	1,000	50 × 105	0.12	6.80	ERWY401LGC102MCA5M	3,300		76.2 × 155	0.12	17.7	ERWY451LGC332MEF5M	
	1,400	50 × 130	0.12	8.90	ERWY401LGC142MCD0M	3,700		76.2 × 170	0.12	19.5	ERWY451LGC372MEH0M	
	1,500	63.5 × 96	0.12	9.10	ERWY401LGC152MD96M	4,600		89 × 155	0.12	22.2	ERWY451LGC462MFF5M	
	1,600	50 × 145	0.12	9.90	ERWY401LGC162MCE5M	5,100		89 × 170	0.12	24.1	ERWY451LGC512MFH0M	
	2,000	63.5 × 115	0.12	11.5	ERWY401LGC202MDB5M	5,700	89 × 190	0.12	27.1	ERWY451LGC572MFK0M		
	2,300	63.5 × 130	0.12	13.0	ERWY401LGC232MDD0M	6,400	100 × 190	0.12	30.6	ERWY451LGC642MGK0M		
	2,800	63.5 × 155	0.12	15.5	ERWY401LGC282MDF5M	7,600	100 × 220	0.12	35.6	ERWY451LGC762MGN0M		
	2,900	76.2 × 115	0.12	15.4	ERWY401LGC292MEB5M	9,500	100 × 270	0.12	43.7	ERWY451LGC952MGT0M		

◆RATED RIPPLE CURRENT MULTIPLIERS

● Frequency Multipliers

Frequency (Hz)	120	300	1k	3k
Coefficient	0.83	1.00	1.25	1.33

Note : The endurance of capacitors is reduced with internal heating produced by ripple current at the rate of halving the lifetime with every 5 to 10°C rise. When long life performance is required in actual use, the rms ripple current has to be reduced. Also, for RWY series capacitors, using them at operating voltage less than their rated voltage can extend their lifetime. For details, please contact a representative of Nippon Chemi-Con.

Return Group Chart



LARGE CAPACITANCE ALUMINUM ELECTROLYTIC CAPACITORS Inverter-use screw terminal, 85°C

RWL Series

- High ripple capability
- For train systems and high power consuming inverter circuits
- Endurance with ripple current : 20,000 hours at 85°C
- RoHS Compliant



◆ SPECIFICATIONS

Items	Characteristics
Category	
Temperature Range	-25 to +85°C
Rated Voltage Range	350 to 450V _{dc}
Capacitance Tolerance	±20% (M) (at 20°C, 120Hz)
Leakage Current	I=0.02CV or 5mA, whichever is smaller. Where, I : Max. leakage current (μA), C : Nominal capacitance (μF), V : Rated voltage (V) (at 20°C after 5 minutes)
Dissipation Factor (tan δ)	0.25 max. (at 20°C, 120Hz)
Low Temperature Characteristics	Capacitance change $C(-25°C)/C(+20°C) \geq 0.7$ (at 120Hz)
Insulation Resistance	When measured between the terminals that are connected to each other and to the mounting clamp on the insulating sleeve covering the case by using an insulation resistance meter of 500V _{dc} , the insulation resistance shall not be less than 100MΩ.
Insulation Withstanding Voltage	When a voltage of 2,000V _{ac} is applied for 1 minute between the terminals that are connected to each other and to the mounting clamp on the insulating sleeve covering the case, there shall not be electrical damage.
Endurance	The following specifications shall be satisfied when the capacitors are restored to 20°C after subjected to DC voltage with the rated ripple current is applied (the peak voltage shall not exceed the rated voltage) for 20,000 hours at 85°C.
	Capacitance change $\leq \pm 30\%$ of the initial value
	D.F. (tan δ) $\leq 300\%$ of the initial specified value
	Leakage current \leq The initial specified value
Shelf Life	The following specifications shall be satisfied when the capacitors are restored to 20°C after exposing them for 500 hours at 85°C without voltage applied. Before the measurement, the capacitor shall be preconditioned by applying voltage according to Item 4.1 of JIS C 5101-4.
	Capacitance change $\leq \pm 20\%$ of the initial value
	D.F. (tan δ) $\leq 300\%$ of the initial specified value
	Leakage current \leq The initial specified value

◆ DIMENSIONS (Screw-Mount) [mm]

● Terminal Code : LG

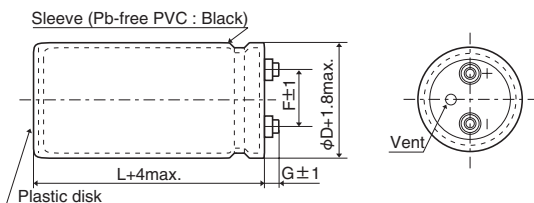

φ63.5 : G=6
φ76.2 & φ89 : G=5

● Mounting Clamp Code : B

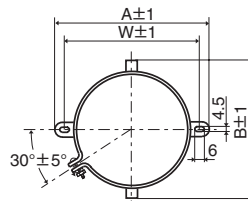

φD	A	B	W	F
63.5	90.0	76.0	80.0	28.0
76.2	104.5	90.0	93.5	31.5

● Mounting Clamp Code : C

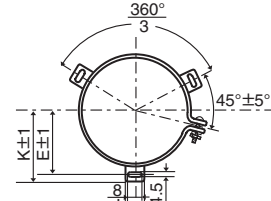

φD	E	K	F	J
63.5	38.1	43.5	28.0	14.0
76.2	44.5	50.0	31.5	14.0
89	50.8	56.5	31.5	16.0

<Screw specifications>

Plus hexagon-headed screw : M5×0.8×10

Maximum screw tightening torque : 3.23Nm

* The screw and the mounting clamp are separately supplied and not attached to the product.

◆ PART NUMBERING SYSTEM

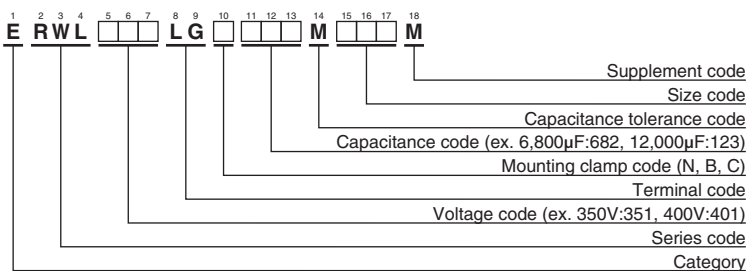

Please refer to "Product code guide (screw-mount terminal type)"

Return Group Chart



LARGE CAPACITANCE ALUMINUM ELECTROLYTIC CAPACITORS Inverter-use screw terminal, 85°C

RWLSeries

◆STANDARD RATINGS

WV (V _{dc})	Cap (μF)	Case size φD×L(mm)	tan δ	Rated ripple current (Arms/85°C, 120Hz)	Part No.	WV (V _{dc})	Cap (μF)	Case size φD×L(mm)	tan δ	Rated ripple current (Arms/85°C, 120Hz)	Part No.	
350	3,300	63.5 × 115	0.25	11.1	ERWL351LGC332MDB5M	400	5,600	63.5 × 190	0.25	18.2	ERWL401LGC562MDK0M	
	3,900	63.5 × 130	0.25	12.8	ERWL351LGC392MDD0M		5,600	76.2 × 155	0.25	18.3	ERWL401LGC562MEF5M	
	4,700	63.5 × 155	0.25	15.2	ERWL351LGC472MDF5M		6,800	76.2 × 170	0.25	21.0	ERWL401LGC682MEH0M	
	4,700	76.2 × 115	0.25	14.7	ERWL351LGC472MEB5M		8,200	89 × 155	0.25	24.1	ERWL401LGC822MFF5M	
	5,600	63.5 × 170	0.25	17.3	ERWL351LGC562MDH0M		10,000	89 × 190	0.25	29.1	ERWL401LGC103MFK0M	
	5,600	76.2 × 130	0.25	16.9	ERWL351LGC562MED0M		450	2,200	63.5 × 115	0.25	9.10	ERWL451LGC222MDB5M
	6,800	63.5 × 190	0.25	20.0	ERWL351LGC682MDK0M			2,700	63.5 × 130	0.25	10.6	ERWL451LGC272MDD0M
	6,800	76.2 × 155	0.25	20.2	ERWL351LGC682MEF5M			2,700	76.2 × 115	0.25	11.2	ERWL451LGC272MEB5M
	8,200	76.2 × 170	0.25	23.1	ERWL351LGC822MEH0M			3,300	63.5 × 155	0.25	12.7	ERWL451LGC332MDF5M
	10,000	89 × 155	0.25	26.6	ERWL351LGC103MFF5M			3,300	76.2 × 130	0.25	13.0	ERWL451LGC332MED0M
12,000	89 × 190	0.25	32.0	ERWL351LGC123MFK0M	3,900	63.5 × 170		0.25	14.4	ERWL451LGC392MDH0M		
400	2,700	63.5 × 115	0.25	10.1	ERWL401LGC272MDB5M	4,700		76.2 × 155	0.25	16.7	ERWL451LGC472MEF5M	
	3,300	63.5 × 130	0.25	11.7	ERWL401LGC332MDD0M	5,600		76.2 × 190	0.25	20.1	ERWL451LGC562MEK0M	
	3,900	63.5 × 155	0.25	13.8	ERWL401LGC392MDF5M	5,600		89 × 155	0.25	19.9	ERWL451LGC562MFF5M	
	3,900	76.2 × 115	0.25	14.7	ERWL401LGC392MEB5M	6,800		89 × 170	0.25	23.0	ERWL451LGC682MFH0M	
	4,700	63.5 × 170	0.25	15.8	ERWL401LGC472MDH0M	8,200	89 × 190	0.25	26.4	ERWL451LGC822MFK0M		
	4,700	76.2 × 130	0.25	15.5	ERWL401LGC472MED0M							

◆RATED RIPPLE CURRENT MULTIPLIERS

●Frequency Multipliers

Frequency (Hz)	50	120	300	1k	3k
Coefficient	0.8	1.0	1.1	1.3	1.4

Note : The endurance of capacitors is reduced with internal heating produced by ripple current at the rate of halving the lifetime with every 5 to 10°C rise. When long life performance is required in actual use, the rms ripple current has to be reduced. Also, for RWL series capacitors, using them at operating voltage less than their rated voltage can extend their lifetime. For details, please contact a representative of Nippon Chemi-Con.

Return Group Chart



LARGE CAPACITANCE ALUMINUM ELECTROLYTIC CAPACITORS Inverter-use screw terminal, 85°C

RHASeries

- Realized higher voltage than RWF series (500 to 650V_{dc})
- Endurance with ripple current : 5,000 hours at 85°C
- Suitable for high voltage inverter
- RoHS compliant

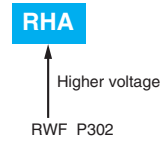

◆SPECIFICATIONS

Items	Characteristics						
Category							
Temperature Range	-25 to +85°C						
Rated Voltage Range	500 to 650V _{dc}						
Capacitance Tolerance	±20% (M) (at 20°C, 120Hz)						
Leakage Current	I=0.02CV or 5mA, whichever is smaller. Where, I : Max. leakage current (μA), C : Nominal capacitance (μF), V : Rated voltage (V) (at 20°C after 5 minutes)						
Dissipation Factor (tan δ)	0.25 max. (at 20°C, 120Hz)						
Low Temperature Characteristics	Capacitance change $C(-25°C)/C(+20°C) \geq 0.6$ (at 120Hz)						
Insulation Resistance	When measured between the terminals that are connected to each other and to the mounting clamp on the insulating sleeve covering the case by using an insulation resistance meter of 500V _{dc} , the insulation resistance shall not be less than 100MΩ.						
Insulation Withstanding Voltage	When a voltage of 2,000V _{ac} is applied for 1 minute between the terminals that are connected to each other and to the mounting clamp on the insulating sleeve covering the case, there shall not be electrical damage.						
Endurance	The following specifications shall be satisfied when the capacitors are restored to 20°C after subjected to DC voltage with the rated ripple current is applied (the peak voltage shall not exceed the rated voltage) for 5,000 hours at 85°C. <table border="1"> <tr> <td>Capacitance change</td> <td>≤ ±20% of the initial value</td> </tr> <tr> <td>D.F. (tan δ)</td> <td>≤ 200% of the initial specified value</td> </tr> <tr> <td>Leakage current</td> <td>≤ The initial specified value</td> </tr> </table>	Capacitance change	≤ ±20% of the initial value	D.F. (tan δ)	≤ 200% of the initial specified value	Leakage current	≤ The initial specified value
Capacitance change	≤ ±20% of the initial value						
D.F. (tan δ)	≤ 200% of the initial specified value						
Leakage current	≤ The initial specified value						
Shelf Life	The following specifications shall be satisfied when the capacitors are restored to 20°C after exposing them for 500 hours at 85°C without voltage applied. Before the measurement, the capacitor shall be preconditioned by applying voltage according to Item 4.1 of JIS C 5101-4. <table border="1"> <tr> <td>Capacitance change</td> <td>≤ ±20% of the initial value</td> </tr> <tr> <td>D.F. (tan δ)</td> <td>≤ 200% of the initial specified value</td> </tr> <tr> <td>Leakage current</td> <td>≤ The initial specified value</td> </tr> </table>	Capacitance change	≤ ±20% of the initial value	D.F. (tan δ)	≤ 200% of the initial specified value	Leakage current	≤ The initial specified value
Capacitance change	≤ ±20% of the initial value						
D.F. (tan δ)	≤ 200% of the initial specified value						
Leakage current	≤ The initial specified value						

◆DIMENSIONS (Screw-Mount) [mm]

● Terminal Code : LG

● Mounting Clamp Code : B

● Mounting Clamp Code : C

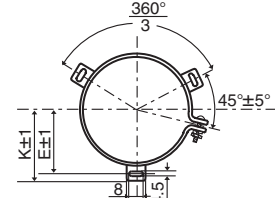
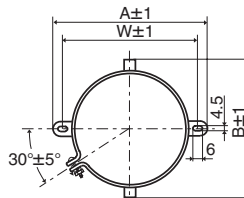
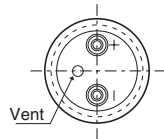
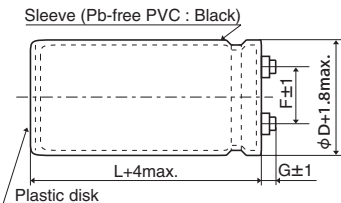

φD	A	B	W	F
50	78.0	64.0	68.0	22.4
63.5	90.0	76.0	80.0	28.0
76.2	104.5	90.0	93.5	31.5

φD	E	K	F	J
50	32.5	37.0	22.4	14.0
63.5	38.1	43.5	28.0	14.0
76.2	44.5	50.0	31.5	14.0
89	50.8	56.5	31.5	16.0
100	56.5	63.4	41.5	18.0

- φ50 & φ63.5 : G=6
- φ76.2 & φ89 : G=5
- φ100 : G=10

<Screw specifications>

to φ89 Plus hexagon-headed screw : M5×0.8×10
Maximum screw tightening torque : 3.23Nm

φ100 Cross-recessed head (Phillips) screw : M8×1.25×16
Spring washer, Washer
Maximum screw tightening torque : 6.31Nm

* The screw and the mounting clamp are separately supplied and not attached to the product.

◆PART NUMBERING SYSTEM

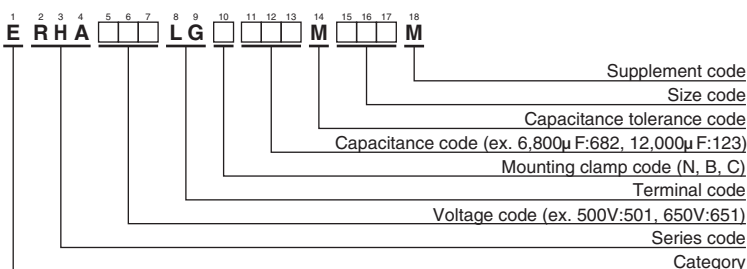

Please refer to "Product code guide (screw-mount terminal type)"

Return Group Chart



LARGE CAPACITANCE ALUMINUM ELECTROLYTIC CAPACITORS Inverter-use screw terminal, 85°C

RHASeries

◆STANDARD RATINGS

WV (V _{dc})	Cap (μF)	Case size φD×L(mm)	tan δ	Rated ripple current (Arms/85°C,120Hz)	Part No.	WV (V _{dc})	Cap (μF)	Case size φD×L(mm)	tan δ	Rated ripple current (Arms/85°C,120Hz)	Part No.
500	1,200	50×95	0.25	5.90	ERHA501LGC122MC95M	550	5,600	89×150	0.25	18.2	ERHA551LGC562MFF0M
	1,500	50×115	0.25	7.20	ERHA501LGC152MCB5M		6,800	89×170	0.25	21.1	ERHA551LGC682MFH0M
	1,800	50×130	0.25	8.30	ERHA501LGC182MCD0M		8,200	100×170	0.25	24.8	ERHA551LGC822MGH0M
	2,200	50×150	0.25	9.80	ERHA501LGC222MCF0M		10,000	100×200	0.25	29.4	ERHA551LGC103MGL0M
	2,700	63.5×120	0.25	11.2	ERHA501LGC272MDC0M		600	1,200	63.5×95	0.25	6.70
	3,300	63.5×140	0.25	13.3	ERHA501LGC332MDE0M	1,500		63.5×110	0.25	8.00	ERHA601LGC152MDB0M
	3,900	63.5×170	0.25	15.7	ERHA501LGC392MDH0M	1,800		63.5×125	0.25	9.30	ERHA601LGC182MDC5M
	3,900	76.2×130	0.25	15.4	ERHA501LGC392MED0M	1,800		76.2×95	0.25	9.10	ERHA601LGC182ME95M
	4,700	76.2×150	0.25	18.1	ERHA501LGC472MEF0M	2,200		63.5×145	0.25	11.0	ERHA601LGC222MDE5M
	5,600	76.2×170	0.25	20.8	ERHA501LGC562MEH0M	2,200		76.2×110	0.25	10.8	ERHA601LGC222MEB0M
	5,600	89×130	0.25	17.1	ERHA501LGC562MFD0M	2,700		63.5×170	0.25	13.1	ERHA601LGC272MDH0M
	6,800	89×150	0.25	20.0	ERHA501LGC682MFF0M	2,700		76.2×125	0.25	12.6	ERHA601LGC272MEC5M
	8,200	89×190	0.25	24.4	ERHA501LGC822MFK0M	3,300		76.2×145	0.25	14.9	ERHA601LGC332MEE5M
	10,000	89×210	0.25	28.2	ERHA501LGC103MFM0M	3,900		76.2×170	0.25	17.3	ERHA601LGC392MEH0M
	12,000	100×210	0.25	32.9	ERHA501LGC123MGM0M	3,900		89×130	0.25	14.2	ERHA601LGC392MFD0M
15,000	100×250	0.25	39.8	ERHA501LGC153MGR0M	4,700	76.2×190		0.25	20.0	ERHA601LGC472MEK0M	
550	1,000	50×95	0.25	5.40	ERHA551LGC102MC95M	4,700		89×150	0.25	16.6	ERHA601LGC472MFF0M
	1,200	50×110	0.25	6.30	ERHA551LGC122MCB0M	5,600		89×170	0.25	19.1	ERHA601LGC562MFH0M
	1,500	50×130	0.25	7.60	ERHA551LGC152MCD0M	650		1,000	63.5×100	0.25	6.30
	1,800	63.5×105	0.25	8.60	ERHA551LGC182MDA5M		1,200	63.5×110	0.25	7.20	ERHA651LGC122MDB0M
	2,200	63.5×120	0.25	10.1	ERHA551LGC222MDC0M		1,500	63.5×130	0.25	8.60	ERHA651LGC152MDD0M
	2,700	63.5×150	0.25	12.4	ERHA551LGC272MDF0M		1,800	63.5×150	0.25	10.1	ERHA651LGC182MDF0M
	2,700	76.2×105	0.25	11.7	ERHA551LGC272MEA5M		2,200	63.5×170	0.25	11.7	ERHA651LGC222MDH0M
	3,300	63.5×170	0.25	14.5	ERHA551LGC332MDH0M		2,700	76.2×150	0.25	13.6	ERHA651LGC272MEF0M
	3,300	76.2×130	0.25	14.2	ERHA551LGC332MED0M		3,300	76.2×170	0.25	15.8	ERHA651LGC332MEH0M
	3,900	76.2×140	0.25	15.9	ERHA551LGC392MEE0M		3,900	89×155	0.25	15.3	ERHA651LGC392MFF5M
	4,700	76.2×170	0.25	19.1	ERHA551LGC472MEH0M		4,700	89×190	0.25	18.4	ERHA651LGC472MFK0M
	4,700	89×130	0.25	15.6	ERHA551LGC472MFD0M						

◆RATED RIPPLE CURRENT MULTIPLIERS

● Frequency Multipliers

Frequency (Hz)	50	120	300	1k	3k
Coefficient	0.8	1.0	1.2	1.3	1.4

Note : The endurance of capacitors is reduced with internal heating produced by ripple current at the rate of halving the lifetime with every 5 to 10°C rise. When long life performance is required in actual use, the rms ripple current has to be reduced. Also, for the RHA series capacitors, using them at operating voltage less than their rated voltage can extend their lifetime. For details, please contact a representative of Nippon Chemi-Con.

Return Group Chart



LARGE CAPACITANCE ALUMINUM ELECTROLYTIC CAPACITORS Inverter-use screw terminal, 85°C

FTP Series

- Ideal for inverter smoothing capacitors such as Electric Vehicles, Hybrid Cars, etc.
- Endurance with ripple current : 5,000 hours at 85°C
- Rated voltage range : 63 to 450V_{dc}
- Lower profile offers drastic space saving compared with conventional cylindrical type
- Superior heat radiation realizes higher ripple current
- RoHS Compliant



◆ SPECIFICATIONS

Items	Characteristics
Category	
Temperature Range	-40 to +85°C (63~100V _{dc}), -25 to +85°C (350~450V _{dc})
Rated Voltage Range	63 to 450V _{dc}
Capacitance Tolerance	±20% (M) (at 20°C, 120Hz)
Leakage Current	I=0.02CV or 5mA, whichever is smaller. Where, I : Max. leakage current (μA), C : Nominal capacitance (μF), V : Rated voltage (V) (at 20°C after 5 minutes)
Dissipation Factor (tan δ)	0.25 max. (at 20°C, 120Hz)
Low Temperature Characteristics	Capacitance change 63 to 100V _{dc} : C(-40°C)/C(+20°C) ≥ 0.6 350 to 450V _{dc} : C(-25°C)/C(+20°C) ≥ 0.7 (at 120Hz)
Endurance	The following specifications shall be satisfied when the capacitors are restored to 20°C after subjected to DC voltage with the rated ripple current is applied (the peak voltage shall not exceed the rated voltage) for 5,000 hours at 85°C.
	Capacitance change ≤ ±20% of the initial value
	D.F. (tan δ) ≤ 200% of the initial specified value
	Leakage current ≤ The initial specified value
Shelf Life	The following specifications shall be satisfied when the capacitors are restored to 20°C after exposing them for 1,000 hours at 85°C without voltage applied. Before the measurement, the capacitor shall be preconditioned by applying voltage according to Item 4.1 of JIS C 5101-4.
	Capacitance change ≤ ±20% of the initial value
	D.F. (tan δ) ≤ 200% of the initial specified value
	Leakage current ≤ The initial specified value

◆ DIMENSIONS (Screw-Mount) [mm]

- Terminal Code : LG
- Size Code : L

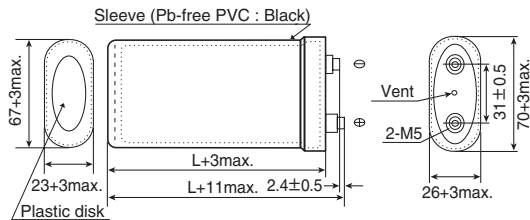

- Size Code : R

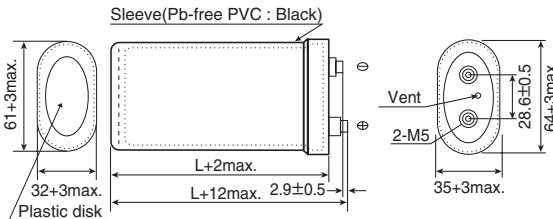

* Polyolefin is available upon request.

<Screw specifications>

Plus hexagon-headed screw: M5×0.8

Maximum screw tightening torque: 3.23Nm

◆ PART NUMBERING SYSTEM

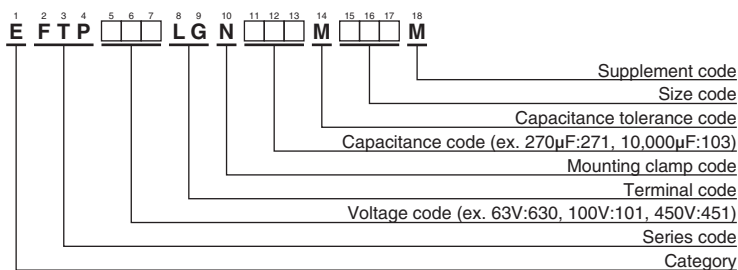

Please refer to "Product code guide (screw-mount terminal type)"

◆ SIZE CODE

Code	Case size H×W×L (mm)
L50	26×70×50
L75	26×70×75
L95	26×70×95
R50	35×64×50
R75	35×64×75
R95	35×64×95

Return Group Chart



LARGE CAPACITANCE ALUMINUM ELECTROLYTIC CAPACITORS Inverter-use screw terminal, 85°C

FTP Series

◆STANDARD RATINGS

WV (V _{dc})	Cap (μF)	Case size H×W×L(mm)	tan δ	Rated ripple current (Arms/85°C, 10kHz)	Part No.	WV (V _{dc})	Cap (μF)	Case size H×W×L(mm)	tan δ	Rated ripple current (Arms/85°C, 10kHz)	Part No.
63	6,000	26×70×50	0.25	14.0	EFTP630LGN602ML50M	350	400	26×70×50	0.25	10.6	EFTP351LGN401ML50M
	12,000	26×70×75	0.25	19.0	EFTP630LGN123ML75M		800	26×70×75	0.25	15.7	EFTP351LGN801ML75M
	17,000	26×70×95	0.25	22.0	EFTP630LGN173ML95M		1,100	26×70×95	0.25	18.7	EFTP351LGN112ML95M
	7,400	35×64×50	0.25	16.1	EFTP630LGN742MR50M		490	35×64×50	0.25	11.9	EFTP351LGN491MR50M
	15,000	35×64×75	0.25	21.7	EFTP630LGN153MR75M		970	35×64×75	0.25	17.6	EFTP351LGN971MR75M
	21,000	35×64×95	0.25	25.3	EFTP630LGN213MR95M		1,400	35×64×95	0.25	21.0	EFTP351LGN142MR95M
80	4,300	26×70×50	0.25	14.0	EFTP800LGN432ML50M	400	330	26×70×50	0.25	10.6	EFTP401LGN331ML50M
	8,600	26×70×75	0.25	19.0	EFTP800LGN862ML75M		660	26×70×75	0.25	15.7	EFTP401LGN661ML75M
	12,000	26×70×95	0.25	22.0	EFTP800LGN123ML95M		930	26×70×95	0.25	18.7	EFTP401LGN931ML95M
	5,300	35×64×50	0.25	16.1	EFTP800LGN532MR50M		400	35×64×50	0.25	11.9	EFTP401LGN401MR50M
	10,000	35×64×75	0.25	21.7	EFTP800LGN103MR75M		800	35×64×75	0.25	17.6	EFTP401LGN801MR75M
	15,000	35×64×95	0.25	25.3	EFTP800LGN153MR95M		1,100	35×64×95	0.25	21.0	EFTP401LGN112MR95M
100	2,900	26×70×50	0.25	14.0	EFTP101LGN292ML50M	450	270	26×70×50	0.25	10.1	EFTP451LGN271ML50M
	5,700	26×70×75	0.25	19.0	EFTP101LGN572ML75M		540	26×70×75	0.25	15.0	EFTP451LGN541ML75M
	8,100	26×70×95	0.25	22.0	EFTP101LGN812ML95M		760	26×70×95	0.25	18.0	EFTP451LGN761ML95M
	3,600	35×64×50	0.25	16.1	EFTP101LGN362MR50M		330	35×64×50	0.25	11.4	EFTP451LGN331MR50M
	7,100	35×64×75	0.25	21.7	EFTP101LGN712MR75M		660	35×64×75	0.25	16.7	EFTP451LGN661MR75M
	10,000	35×64×95	0.25	25.3	EFTP101LGN103MR95M		930	35×64×95	0.25	20.1	EFTP451LGN931MR95M

◆Improvement of space factor and heat radiation

Dead spaces are found in the conventional cylindrical shape. But lower profile offers reduced dead space, and makes the equipment smaller in size. Moreover, the internal element of the lower profile capacitor is in greater contact with the can. This greatly improves the heat dissipation compared with the cylindrical shape.

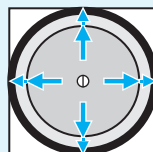

Cylindrical shape

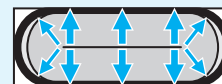

FTP series

Return Group Chart



LARGE CAPACITANCE ALUMINUM ELECTROLYTIC CAPACITORS long life screw terminals, 105°C

LXA Series

- Rated voltage range up to 525V_{dc}
- Endurance with ripple current : 5,000 hours at 105°C (2,000 hours for 500V_{dc} & 525V_{dc})
- RoHS Compliant

LXA

Long life

KMH P294



SPECIFICATIONS

Items	Characteristics												
Category	-40 to +105°C (10 to 100V _{dc}) -25 to +105°C (160 to 525V _{dc})												
Temperature Range													
Rated Voltage Range	10 to 525V _{dc}												
Capacitance Tolerance	-10 to +50% (T) (10 to 250V _{dc}) ±20% (M) (350 to 525V _{dc}) (at 20°C, 120Hz)												
Leakage Current	I=0.02CV or 5mA, whichever is smaller. Where, I : Max. leakage current (μA), C : Nominal capacitance (μF), V : Rated voltage (V) (at 20°C after 5 minutes)												
Dissipation Factor (tan δ)	See STANDARD RATINGS (10 to 250V _{dc}) 0.20max. (350 to 525V _{dc}) (at 20°C, 120Hz)												
Low Temperature Characteristics	Capacitance change C(-40°C)/C(+20°C) ≥ 0.6(10 to 100V _{dc}) C(-25°C)/C(+20°C) ≥ 0.7(160 to 250V _{dc}) C(-25°C)/C(+20°C) ≥ 0.65(350 to 525V _{dc}) (at 120Hz)												
Insulation Resistance	When measured between the terminals that are connected to each other and to the mounting clamp on the insulating sleeve covering the case by using an insulation resistance meter of 500V _{dc} , the insulation resistance shall not be less than 100MΩ.												
Insulation Withstanding Voltage	When a voltage of 2,000V _{ac} is applied for 1 minute between the terminals that are connected to each other and to the mounting clamp on the insulating sleeve covering the case, there shall not be electrical damage.												
Endurance	The following specifications shall be satisfied when the capacitors are restored to 20°C after subjected to DC voltage with the rated ripple current is applied (the peak voltage shall not exceed the rated voltage) for 5,000 hours (2,000 hours for 500 & 525V _{dc} products) at 105°C. <table border="1" style="width: 100%;"> <tr> <td>Capacitance change</td> <td>≤ ±20% of the initial value</td> </tr> <tr> <td>D.F. (tan δ)</td> <td>≤ 200% of the initial specified value</td> </tr> <tr> <td>Leakage current</td> <td>≤ The initial specified value</td> </tr> </table>	Capacitance change	≤ ±20% of the initial value	D.F. (tan δ)	≤ 200% of the initial specified value	Leakage current	≤ The initial specified value						
Capacitance change	≤ ±20% of the initial value												
D.F. (tan δ)	≤ 200% of the initial specified value												
Leakage current	≤ The initial specified value												
Shelf Life	The following specifications shall be satisfied when the capacitors are restored to 20°C after exposing them for 1,000 hours at 105°C without voltage applied. Before the measurement, the capacitor shall be preconditioned by applying voltage according to Item 4.1 of JIS C 5101-4. <table border="1" style="width: 100%;"> <tr> <td>Rated voltage</td> <td>10 to 250V_{dc}</td> <td>350 to 525V_{dc}</td> </tr> <tr> <td>Capacitance change</td> <td>≤ ±15% of the initial value</td> <td>≤ ±20% of the initial value</td> </tr> <tr> <td>D.F. (tan δ)</td> <td>≤ 150% of the initial specified value</td> <td>≤ 200% of the initial specified value</td> </tr> <tr> <td>Leakage current</td> <td>≤ The initial specified value</td> <td>≤ The initial specified value</td> </tr> </table>	Rated voltage	10 to 250V _{dc}	350 to 525V _{dc}	Capacitance change	≤ ±15% of the initial value	≤ ±20% of the initial value	D.F. (tan δ)	≤ 150% of the initial specified value	≤ 200% of the initial specified value	Leakage current	≤ The initial specified value	≤ The initial specified value
Rated voltage	10 to 250V _{dc}	350 to 525V _{dc}											
Capacitance change	≤ ±15% of the initial value	≤ ±20% of the initial value											
D.F. (tan δ)	≤ 150% of the initial specified value	≤ 200% of the initial specified value											
Leakage current	≤ The initial specified value	≤ The initial specified value											

DIMENSIONS (Screw-Mount) [mm]

Terminal Code : LG

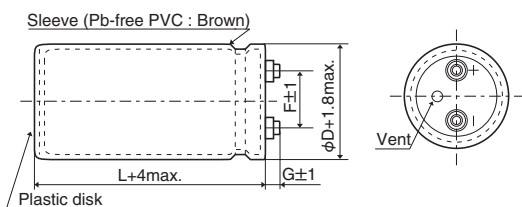

φD	G	
	10 to 250V _{dc}	350 to 525V _{dc}
φ63.5	6	6
φ76.2	5	6
φ89	5	4

Mounting Clamp Code : B

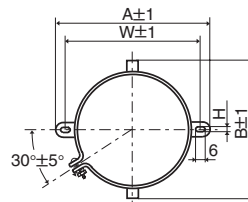

φD	A	B	W	H	F
35	58	44	48	3.5	12.7
50	78	64	68	4.5	22.4
63.5	90	76	80	4.5	28.0
76.2	104.5	90	93.5	4.5	31.5

Mounting Clamp Code : C

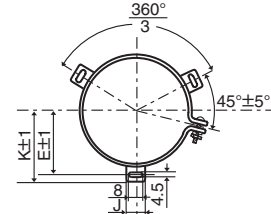

φD	E	K	J	F
50	32.5	37.0	14.0	22.4
63.5	38.1	43.5	14.0	28.0
76.2	44.5	50.0	14.0	31.5
89	50.8	56.5	16.0	31.5

<Screw specifications>

Plus hexagon-headed screw : M5×0.8×10

Maximum screw tightening torque : 3.23Nm

* The screw and the mounting clamp are separately supplied and not attached to the product.

PART NUMBERING SYSTEM

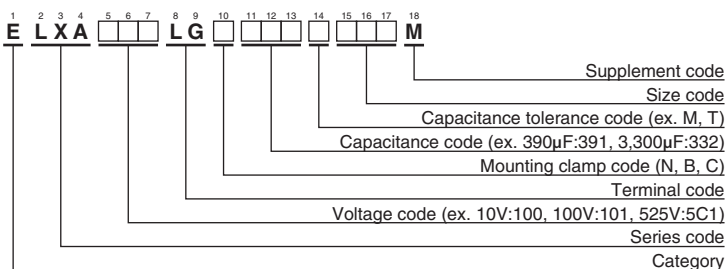

Please refer to "Product code guide (screw-mount terminal type)"

Return Group Chart



LARGE CAPACITANCE ALUMINUM ELECTROLYTIC CAPACITORS long life screw terminals ,105°C

LXA Series

◆ STANDARD RATINGS

WV (V _{dc})	Cap (µF)	Case size φD×L(mm)	tan δ	Rated ripple current (Arms/ 105°C, 120Hz)	Part No.	WV (V _{dc})	Cap (µF)	Case size φD×L(mm)	tan δ	Rated ripple current (Arms/ 105°C, 120Hz)	Part No.	
10	27,000	35 × 80	0.45	4.30	ELXA100LGB273TA80M	50	10,000	35 × 80	0.25	3.70	ELXA500LGB103TA80M	
	33,000	35 × 80	0.45	4.70	ELXA100LGB333TA80M		12,000	35 × 100	0.25	4.40	ELXA500LGB123TAA0M	
	39,000	35 × 80	0.45	5.30	ELXA100LGB393TA80M		15,000	35 × 120	0.30	4.70	ELXA500LGB153TAC0M	
	47,000	35 × 100	0.45	6.10	ELXA100LGB473TAA0M		18,000	50 × 80	0.35	4.80	ELXA500LGC183TC80M	
	56,000	35 × 100	0.50	6.20	ELXA100LGB563TAA0M		22,000	50 × 100	0.35	5.90	ELXA500LGC223TCA0M	
	68,000	35 × 120	0.60	6.80	ELXA100LGB683TAC0M		27,000	50 × 120	0.35	7.00	ELXA500LGC273TCC0M	
	82,000	50 × 80	0.60	7.80	ELXA100LGC823TC80M		33,000	63.5 × 100	0.40	7.60	ELXA500LGC333TDA0M	
	100,000	50 × 100	0.70	8.50	ELXA100LGC104TCA0M		39,000	63.5 × 120	0.40	8.90	ELXA500LGC393TDC0M	
	120,000	50 × 100	0.70	9.50	ELXA100LGC124TCA0M		47,000	63.5 × 120	0.40	9.80	ELXA500LGC473TDC0M	
	150,000	63.5 × 100	0.80	11.0	ELXA100LGC154TDA0M		56,000	76.2 × 120	0.40	11.9	ELXA500LGC563TEC0M	
	180,000	63.5 × 100	0.80	12.1	ELXA100LGC184TDA0M		68,000	76.2 × 140	0.45	13.1	ELXA500LGC683TEE0M	
	220,000	76.2 × 100	1.00	13.2	ELXA100LGC224TEA0M		82,000	89 × 140	0.50	14.8	ELXA500LGC823TFE0M	
	270,000	76.2 × 120	1.20	14.4	ELXA100LGC274TEC0M		63	2,700	35 × 50	0.15	1.90	ELXA630LGB272TA50M
	330,000	76.2 × 140	1.20	17.0	ELXA100LGC334TEE0M			3,300	35 × 50	0.15	2.10	ELXA630LGB332TA50M
390,000	89 × 140	1.40	18.6	ELXA100LGC394TFE0M	3,900	35 × 80		0.20	2.70	ELXA630LGB392TA80M		
16	15,000	35 × 50	0.45	2.90	ELXA160LGB153TA50M	4,700		35 × 80	0.20	2.90	ELXA630LGB472TA80M	
	18,000	35 × 80	0.45	3.50	ELXA160LGB183TA80M	5,600		35 × 80	0.20	3.20	ELXA630LGB562TA80M	
	22,000	35 × 80	0.45	3.90	ELXA160LGB223TA80M	6,800		35 × 80	0.20	3.50	ELXA630LGB682TA80M	
	27,000	35 × 80	0.45	4.30	ELXA160LGB273TA80M	8,200		35 × 100	0.20	4.20	ELXA630LGB822TAA0M	
	33,000	35 × 100	0.50	4.80	ELXA160LGB333TAA0M	10,000		35 × 120	0.25	4.30	ELXA630LGB103TAC0M	
	39,000	35 × 100	0.50	5.30	ELXA160LGB393TAA0M	12,000		50 × 80	0.25	4.80	ELXA630LGC123TC80M	
	47,000	35 × 120	0.50	6.20	ELXA160LGB473TAC0M	15,000		50 × 100	0.25	5.90	ELXA630LGC153TCA0M	
	56,000	50 × 80	0.60	6.30	ELXA160LGC563TC80M	18,000		50 × 120	0.25	6.30	ELXA630LGC183TCC0M	
	68,000	50 × 100	0.60	7.60	ELXA160LGC683TCA0M	22,000		50 × 120	0.30	6.70	ELXA630LGC223TCC0M	
	82,000	50 × 120	0.70	8.30	ELXA160LGC823TCC0M	27,000		63.5 × 120	0.30	8.80	ELXA630LGC273TDC0M	
	100,000	50 × 120	0.70	9.20	ELXA160LGC104TCC0M	33,000		76.2 × 100	0.30	10.0	ELXA630LGC333TEA0M	
	120,000	63.5 × 100	0.80	9.90	ELXA160LGC124TDA0M	39,000	76.2 × 120	0.35	10.7	ELXA630LGC393TEC0M		
	150,000	76.2 × 100	0.80	12.3	ELXA160LGC154TEA0M	47,000	76.2 × 140	0.35	12.5	ELXA630LGC473TEE0M		
	180,000	76.2 × 120	0.80	14.5	ELXA160LGC184TEC0M	56,000	89 × 140	0.40	13.8	ELXA630LGC563TFE0M		
220,000	76.2 × 140	1.00	15.2	ELXA160LGC224TEE0M	80	2,200	35 × 50	0.15	1.90	ELXA800LGB222TA50M		
270,000	89 × 140	1.20	16.8	ELXA160LGC274TFE0M		2,700	35 × 80	0.15	2.20	ELXA800LGB272TA80M		
25	12,000	35 × 80	0.35	3.30		ELXA250LGB123TA80M	3,300	35 × 80	0.15	2.50	ELXA800LGB332TA80M	
	15,000	35 × 80	0.35	3.70		ELXA250LGB153TA80M	3,900	35 × 80	0.15	2.90	ELXA800LGB392TA80M	
	18,000	35 × 80	0.35	4.00		ELXA250LGB183TA80M	4,700	35 × 100	0.15	3.10	ELXA800LGB472TAA0M	
	22,000	35 × 80	0.35	4.50		ELXA250LGB223TA80M	5,600	35 × 100	0.15	3.50	ELXA800LGB562TAA0M	
	27,000	35 × 100	0.40	5.00		ELXA250LGB273TAA0M	6,800	35 × 120	0.20	4.10	ELXA800LGB682TAC0M	
	33,000	35 × 120	0.40	5.90		ELXA250LGB333TAC0M	8,200	50 × 80	0.20	4.80	ELXA800LGC822TC80M	
	39,000	50 × 80	0.40	6.50		ELXA250LGC393TC80M	10,000	50 × 100	0.20	5.60	ELXA800LGC103TCA0M	
	47,000	50 × 100	0.40	7.90		ELXA250LGC473TCA0M	12,000	50 × 100	0.20	6.10	ELXA800LGC123TCA0M	
	56,000	50 × 120	0.40	8.80		ELXA250LGC563TCC0M	15,000	50 × 120	0.20	7.40	ELXA800LGC153TCC0M	
	68,000	50 × 120	0.50	9.10		ELXA250LGC683TCC0M	18,000	63.5 × 120	0.25	8.00	ELXA800LGC183TDC0M	
	82,000	63.5 × 100	0.50	10.6		ELXA250LGC823TDA0M	22,000	76.2 × 100	0.25	9.10	ELXA800LGC223TEA0M	
	100,000	63.5 × 120	0.60	11.4		ELXA250LGC104TDC0M	27,000	76.2 × 120	0.30	9.70	ELXA800LGC273TEC0M	
	120,000	76.2 × 100	0.60	12.8	ELXA250LGC124TEA0M	33,000	76.2 × 140	0.30	11.5	ELXA800LGC333TEE0M		
	150,000	76.2 × 120	0.75	13.7	ELXA250LGC154TEC0M	39,000	89 × 140	0.35	12.5	ELXA800LGC393TFE0M		
180,000	76.2 × 140	0.75	16.1	ELXA250LGC184TEE0M	100	1,200	35 × 50	0.15	1.40	ELXA101LGB122TA50M		
220,000	89 × 140	1.00	16.6	ELXA250LGC224TFE0M		1,500	35 × 80	0.15	1.60	ELXA101LGB152TA80M		
35	8,200	35 × 80	0.30	3.00		ELXA350LGB822TA80M	1,800	35 × 80	0.15	1.80	ELXA101LGB182TA80M	
	10,000	35 × 80	0.30	3.30		ELXA350LGB103TA80M	2,200	35 × 80	0.15	2.00	ELXA101LGB222TA80M	
	12,000	35 × 80	0.30	3.60		ELXA350LGB123TA80M	2,700	35 × 80	0.15	2.40	ELXA101LGB272TA80M	
	15,000	35 × 80	0.30	4.10		ELXA350LGB153TA80M	3,300	35 × 100	0.15	2.80	ELXA101LGB332TAA0M	
	18,000	35 × 100	0.30	4.80		ELXA350LGB183TAA0M	3,900	35 × 120	0.15	3.10	ELXA101LGB392TAC0M	
	22,000	35 × 120	0.35	5.20		ELXA350LGB223TAC0M	4,700	50 × 80	0.15	3.60	ELXA101LGC472TC80M	
	27,000	50 × 80	0.40	5.90		ELXA350LGC273TC80M	5,600	50 × 100	0.15	4.30	ELXA101LGC562TCA0M	
	33,000	50 × 100	0.40	6.60		ELXA350LGC333TCA0M	6,800	50 × 120	0.15	5.00	ELXA101LGC682TCC0M	
	39,000	50 × 120	0.40	7.80		ELXA350LGC393TCC0M	8,200	50 × 120	0.15	5.50	ELXA101LGC822TCC0M	
	47,000	50 × 120	0.45	8.00		ELXA350LGC473TCC0M	10,000	63.5 × 100	0.15	6.40	ELXA101LGC103TDA0M	
	56,000	63.5 × 100	0.45	9.20		ELXA350LGC563TDA0M	12,000	63.5 × 120	0.20	6.60	ELXA101LGC123TDC0M	
	68,000	63.5 × 120	0.45	11.0		ELXA350LGC683TDC0M	15,000	76.2 × 100	0.20	7.50	ELXA101LGC153TEA0M	
	82,000	76.2 × 120	0.50	12.7	ELXA350LGC823TEC0M	18,000	76.2 × 120	0.25	8.00	ELXA101LGC183TEC0M		
	100,000	76.2 × 140	0.60	13.5	ELXA350LGC104TEE0M	22,000	76.2 × 140	0.25	9.40	ELXA101LGC223TEE0M		
120,000	89 × 140	0.60	16.1	ELXA350LGC124TFE0M	27,000	89 × 140	0.30	10.4	ELXA101LGC273TFE0M			
50	3,900	35 × 50	0.20	2.00	ELXA500LGB392TA50M	160	680	35 × 50	0.15	1.10	ELXA161LGB681TA50M	
	4,700	35 × 50	0.25	2.20	ELXA500LGB472TA50M		820	35 × 80	0.15	1.20	ELXA161LGB821TA80M	
	5,600	35 × 80	0.25	2.80	ELXA500LGB562TA80M		1,000	35 × 80	0.15	1.30	ELXA161LGB102TA80M	
	6,800	35 × 80	0.25	3.00	ELXA500LGB682TA80M		1,200	35 × 80	0.15	1.50	ELXA161LGB122TA80M	
	8,200	35 × 80	0.25	3.30	ELXA500LGB822TA80M		1,500	35 × 80	0.15	1.70	ELXA161LGB152TA80M	

Product specifications in this catalog are subject to change without notice. Request our product specifications before purchase and/or use. Please use our products based on the information contained in this catalog and product specifications.

Return Group Chart



LARGE CAPACITANCE ALUMINUM ELECTROLYTIC CAPACITORS long life screw terminals ,105°C

LXASeries

◆STANDARD RATINGS

WV (V _{dc})	Cap (μF)	Case size φD×L(mm)	tan δ	Rated ripple current (Arms/105°C, 120Hz)	Part No.	WV (V _{dc})	Cap (μF)	Case size φD×L(mm)	tan δ	Rated ripple current (Arms/105°C, 120Hz)	Part No.
160	1,800	35 × 100	0.15	2.00	ELXA161LGB182TAA0M	400	680	50 × 60	0.20	3.00	ELXA401LGC681MC60M
	2,200	35 × 120	0.15	2.30	ELXA161LGB222TAC0M		1,200	50 × 85	0.20	4.70	ELXA401LGC122MC85M
	2,700	35 × 120	0.15	2.70	ELXA161LGB272TAC0M		1,800	50 × 105	0.20	6.30	ELXA401LGC182MCA5M
	3,300	50 × 100	0.15	3.30	ELXA161LGC332TCA0M		2,200	50 × 125	0.20	7.50	ELXA401LGC222MCC5M
	3,900	50 × 120	0.15	3.80	ELXA161LGC392TCC0M		2,200	63.5 × 85	0.20	7.30	ELXA401LGC222MD85M
	4,700	50 × 120	0.15	4.20	ELXA161LGC472TCC0M		2,700	50 × 145	0.20	8.90	ELXA401LGC272MCE5M
	5,600	50 × 120	0.15	4.70	ELXA161LGC562TCC0M		2,700	63.5 × 105	0.20	8.80	ELXA401LGC272MDA5M
	6,800	63.5 × 120	0.15	5.70	ELXA161LGC682TDC0M		3,300	63.5 × 125	0.20	10.5	ELXA401LGC332MDC5M
	8,200	76.2 × 100	0.20	6.40	ELXA161LGC822TEA0M		3,300	76.2 × 85	0.20	9.90	ELXA401LGC332ME85M
	10,000	76.2 × 120	0.20	6.60	ELXA161LGC103TEC0M		4,700	63.5 × 145	0.20	13.4	ELXA401LGC472MDE5M
	12,000	76.2 × 140	0.20	7.80	ELXA161LGC123TEE0M		4,700	76.2 × 125	0.20	13.9	ELXA401LGC472MCE5M
	15,000	89 × 140	0.20	9.50	ELXA161LGC153TFE0M		6,800	76.2 × 145	0.20	17.9	ELXA401LGC682MEE5M
200	470	35 × 50	0.15	0.90	ELXA201LGB471TA50M	450	560	50 × 60	0.20	2.60	ELXA451LGC561MC60M
	560	35 × 80	0.15	1.00	ELXA201LGB561TA80M		1,000	50 × 85	0.20	4.00	ELXA451LGC102MC85M
	680	35 × 80	0.15	1.10	ELXA201LGB681TA80M		1,200	50 × 105	0.20	4.80	ELXA451LGC122MCA5M
	820	35 × 80	0.15	1.30	ELXA201LGB821TA80M		1,800	50 × 125	0.20	6.40	ELXA451LGC182MCC5M
	1,000	35 × 100	0.15	1.50	ELXA201LGB102TAA0M		1,800	63.5 × 85	0.20	6.20	ELXA451LGC182MD85M
	1,200	35 × 120	0.15	1.70	ELXA201LGB122TAC0M		2,200	50 × 145	0.20	7.60	ELXA451LGC222MCE5M
	1,500	35 × 120	0.15	1.90	ELXA201LGB152TAC0M		2,200	63.5 × 105	0.20	7.50	ELXA451LGC222MDA5M
	1,800	50 × 80	0.15	2.20	ELXA201LGC182TC80M		2,700	63.5 × 125	0.20	8.90	ELXA451LGC272MDC5M
	2,200	50 × 100	0.15	2.70	ELXA201LGC222TCA0M		2,700	76.2 × 85	0.20	8.40	ELXA451LGC272ME85M
	2,700	50 × 120	0.15	3.20	ELXA201LGC272TCC0M		3,300	63.5 × 145	0.20	10.6	ELXA451LGC332MDE5M
	3,300	50 × 120	0.15	3.50	ELXA201LGC332TCC0M		3,300	76.2 × 105	0.20	10.2	ELXA451LGC332MEA5M
	3,900	63.5 × 100	0.15	4.00	ELXA201LGC392TDA0M		3,900	76.2 × 125	0.20	11.9	ELXA451LGC392MEC5M
250	330	35 × 50	0.15	0.70	ELXA251LGB331TA50M	500	470	50 × 60	0.20	2.40	ELXA501LGC471MC60M
	390	35 × 80	0.15	0.80	ELXA251LGB391TA80M		820	50 × 85	0.20	3.60	ELXA501LGC821MC85M
	470	35 × 80	0.15	0.90	ELXA251LGB471TA80M		1,000	50 × 105	0.20	4.40	ELXA501LGC102MCA5M
	560	35 × 80	0.15	1.00	ELXA251LGB561TA80M		1,200	50 × 125	0.20	5.20	ELXA501LGC122MCC5M
	680	35 × 100	0.15	1.20	ELXA251LGB681TAA0M		1,200	63.5 × 85	0.20	5.00	ELXA501LGC122MD85M
	820	35 × 100	0.15	1.40	ELXA251LGB821TAA0M		1,500	50 × 145	0.20	6.30	ELXA501LGC152MCE5M
	1,000	35 × 120	0.15	1.60	ELXA251LGB102TAC0M		1,800	63.5 × 105	0.20	6.80	ELXA501LGC182MDA5M
	1,200	50 × 80	0.15	1.80	ELXA251LGC122TC80M		2,200	63.5 × 145	0.20	9.60	ELXA501LGC272MDE5M
	1,500	50 × 100	0.15	2.20	ELXA251LGC152TCA0M		2,700	76.2 × 105	0.20	9.20	ELXA501LGC272MEA5M
	1,800	50 × 120	0.15	2.60	ELXA251LGC222TCC0M		3,900	76.2 × 145	0.20	12.7	ELXA501LGC392MEE5M
	2,200	50 × 120	0.15	2.80	ELXA251LGC222TCC0M		3,900	89 × 125	0.20	11.9	ELXA501LGC392MFC5M
	2,700	63.5 × 100	0.15	3.30	ELXA251LGC272TDA0M		6,800	89 × 190	0.20	18.8	ELXA501LGC682MFK0M
350	3,300	63.5 × 120	0.15	4.00	ELXA251LGC332TDC0M	525	10,000	89 × 270	0.20	26.8	ELXA501LGC103MFT0M
	3,900	76.2 × 100	0.15	4.40	ELXA251LGC392TEA0M		390	50 × 60	0.20	2.20	ELXA5C1LGC391MC60M
	4,700	76.2 × 120	0.15	5.20	ELXA251LGC472TEC0M		680	50 × 85	0.20	3.30	ELXA5C1LGC681MC85M
	5,600	76.2 × 140	0.15	6.10	ELXA251LGC562TEE0M		1,000	50 × 125	0.20	4.80	ELXA5C1LGC102MCC5M
	6,800	89 × 140	0.15	7.40	ELXA251LGC682TFE0M		1,500	63.5 × 105	0.20	6.20	ELXA5C1LGC152MDA5M
	820	50 × 60	0.20	3.30	ELXA351LGC821MC60M		1,800	63.5 × 125	0.20	7.30	ELXA5C1LGC182MDC5M
	1,500	50 × 85	0.20	5.20	ELXA351LGC152MC85M		2,200	63.5 × 145	0.20	8.60	ELXA5C1LGC222MDE5M
	2,200	50 × 105	0.20	7.00	ELXA351LGC222MCA5M		2,200	76.2 × 105	0.20	8.30	ELXA5C1LGC222MEA5M
	2,700	50 × 125	0.20	8.40	ELXA351LGC272MCC5M		2,700	76.2 × 125	0.20	9.90	ELXA5C1LGC272MEC5M
	2,700	63.5 × 85	0.20	8.10	ELXA351LGC272MD85M		3,300	76.2 × 145	0.20	11.7	ELXA5C1LGC332MEE5M
	3,300	50 × 145	0.20	9.90	ELXA351LGC332MCE5M		4,700	76.2 × 190	0.20	14.4	ELXA5C1LGC472MEK0M
	3,300	63.5 × 105	0.20	9.80	ELXA351LGC332MDA5M		4,700	89 × 145	0.20	13.9	ELXA5C1LGC472MFE5M

Product specifications in this catalog are subject to change without notice. Request our product specifications before purchase and/or use. Please use our products based on the information contained in this catalog and product specifications.



LXA Series

◆ RATED RIPPLE CURRENT MULTIPLIERS

● Frequency Multipliers

Frequency (Hz)	50	120	300	1k	3k	10k	50k
10 to 50V _{dc}	0.95	1.00	1.03	1.05	—	1.09	1.12
63 to 80V _{dc}	0.90	1.00	1.06	1.10	—	1.18	1.22
100 to 250V _{dc}	0.80	1.00	1.12	1.22	—	1.30	1.33
350 to 525V _{dc}	0.80	1.00	1.20	1.50	1.60	—	—

Note : The endurance of capacitors is reduced with internal heating produced by ripple current at the rate of halving the lifetime with every 5 to 10°C rise. When long life performance is requested in actual use, the rms ripple current has to be reduced. Also, for the LXA series capacitors (350 to 525V_{dc} products), using them at operating voltage can extend their lifetime. For details, please contact a representative of Nippon Chemi-con.

Return Group Chart



LARGE CAPACITANCE ALUMINUM ELECTROLYTIC CAPACITORS Inverter-use screw terminals ,105°C

LXR Series

- Higher ripple capability than LXA series
- Endurance with ripple current : 5,000 hours at 105°C
- RoHS Compliant

LXR

Higher ripple
LXA P318



SPECIFICATIONS

Items	Characteristics						
Category	-25 to +105°C						
Temperature Range							
Rated Voltage Range	350 to 450V _{dc}						
Capacitance Tolerance	±20% (M) (at 20°C, 120Hz)						
Leakage Current	I=0.02CV or 5mA, whichever is smaller. Where, I : Max. leakage current (μA), C : Nominal capacitance (μF), V : Rated voltage (V) (at 20°C after 5 minutes)						
Dissipation Factor (tan δ)	0.15max. (at 20°C, 120Hz)						
Low Temperature Characteristics	Capacitance change $C(-25°C)/C(+20°C) \geq 0.7$ (at 120Hz)						
Insulation Resistance	When measured between the terminals that are connected to each other and to the mounting clamp on the insulating sleeve covering the case by using an insulation resistance meter of 500V _{dc} , the insulation resistance shall not be less than 100MΩ.						
Insulation Withstanding Voltage	When a voltage of 2,000V _{ac} is applied for 1 minute between the terminals that are connected to each other and to the mounting clamp on the insulating sleeve covering the case, there shall not be electrical damage.						
Endurance	The following specifications shall be satisfied when the capacitors are restored to 20°C after subjected to DC voltage with the rated ripple current is applied (the peak voltage shall not exceed the rated voltage) for 5,000 hours at 105°C. <table border="1"> <tr> <td>Capacitance change</td> <td>≤ ±20% of the initial value</td> </tr> <tr> <td>D.F. (tan δ)</td> <td>≤ 200% of the initial specified value</td> </tr> <tr> <td>Leakage current</td> <td>≤ The initial specified value</td> </tr> </table>	Capacitance change	≤ ±20% of the initial value	D.F. (tan δ)	≤ 200% of the initial specified value	Leakage current	≤ The initial specified value
Capacitance change	≤ ±20% of the initial value						
D.F. (tan δ)	≤ 200% of the initial specified value						
Leakage current	≤ The initial specified value						
Shelf Life	The following specifications shall be satisfied when the capacitors are restored to 20°C after exposing them for 1,000 hours at 105°C without voltage applied. Before the measurement, the capacitor shall be preconditioned by applying voltage according to Item 4.1 of JIS C 5101-4. <table border="1"> <tr> <td>Capacitance change</td> <td>≤ ±20% of the initial value</td> </tr> <tr> <td>D.F. (tan δ)</td> <td>≤ 200% of the initial specified value</td> </tr> <tr> <td>Leakage current</td> <td>≤ The initial specified value</td> </tr> </table>	Capacitance change	≤ ±20% of the initial value	D.F. (tan δ)	≤ 200% of the initial specified value	Leakage current	≤ The initial specified value
Capacitance change	≤ ±20% of the initial value						
D.F. (tan δ)	≤ 200% of the initial specified value						
Leakage current	≤ The initial specified value						

DIMENSIONS (Screw-Mount) [mm]

Terminal Code : LG

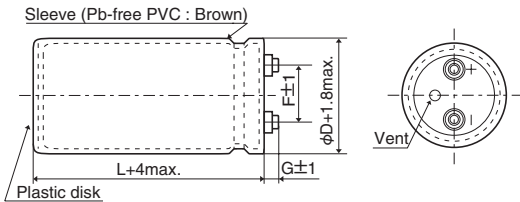

φ63.5 & φ76.2 : G=6
φ89 : G=4
φ100 : G=10

<Screw specifications>

to φ89 Plus hexagon-headed screw :M5×0.8×10
Maximum screw tightening torque :3.23Nm

Mounting Clamp Code : B

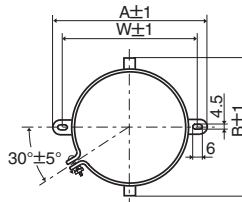

φD	A	B	W	F
63.5	90	76	80	28.0
76.2	104.5	90	93.5	31.5

Mounting Clamp Code : C

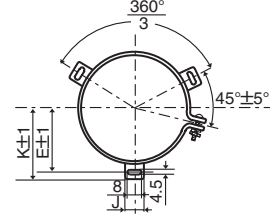

φD	E	K	F	J
63.5	38.1	43.5	28.0	14.0
76.2	44.5	50.0	31.5	14.0
89	50.8	56.5	31.5	16.0
100	56.5	63.4	41.5	18.0

φ100 Cross-recessed head (Phillips) screw : M8×1.25×16
Spring washer, Washer
Maximum screw tightening torque :6.31Nm

* The screw and the mounting clamp are separately supplied and not attached to the product.

PART NUMBERING SYSTEM

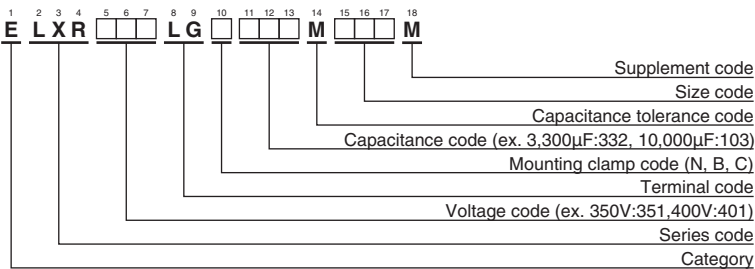

Please refer to "Product code guide (screw-mount terminal type)"

Return Group Chart



LARGE CAPACITANCE ALUMINUM ELECTROLYTIC CAPACITORS Inverter-use screw terminals ,105°C

LXRSeries

◆STANDARD RATINGS

WV (V _{dc})	Cap (μF)	Case size φD×L(mm)	tan δ	Rated ripple current (Arms/105°C, 120Hz)	Part No.	WV (V _{dc})	Cap (μF)	Case size φD×L(mm)	tan δ	Rated ripple current (Arms/105°C, 120Hz)	Part No.
350	3,300	63.5 × 115	0.15	14.4	ELXR351LGC332MDB5M	400	6,800	76.2 × 170	0.15	27.3	ELXR401LGC682MEH0M
	3,900	63.5 × 130	0.15	16.6	ELXR351LGC392MDD0M		6,800	89 × 155	0.15	26.6	ELXR401LGC682MFF5M
	4,700	63.5 × 155	0.15	19.8	ELXR351LGC472MDF5M		8,200	89 × 170	0.15	30.5	ELXR401LGC822MFH0M
	4,700	76.2 × 115	0.15	19.1	ELXR351LGC472MEB5M		10,000	100 × 190	0.15	34.5	ELXR401LGC103MGK0M
	5,600	63.5 × 170	0.15	22.5	ELXR351LGC562MDH0M		12,000	100 × 220	0.15	40.2	ELXR401LGC123MGN0M
	5,600	76.2 × 130	0.15	21.9	ELXR351LGC562MED0M		450	2,200	63.5 × 115	0.15	11.8
	6,800	76.2 × 155	0.15	26.2	ELXR351LGC682MEF5M	2,700		63.5 × 130	0.15	13.7	ELXR451LGC272MDD0M
	8,200	76.2 × 170	0.15	30.0	ELXR351LGC822MEH0M	2,700		76.2 × 115	0.15	14.5	ELXR451LGC272MEB5M
	8,200	89 × 155	0.15	29.2	ELXR351LGC822MFF5M	3,300		63.5 × 155	0.15	16.5	ELXR451LGC332MDF5M
	10,000	89 × 170	0.15	33.7	ELXR351LGC103MFH0M	3,300		76.2 × 130	0.15	16.9	ELXR451LGC332MED0M
	12,000	100 × 190	0.15	37.8	ELXR351LGC123MGK0M	3,900		63.5 × 170	0.15	18.7	ELXR451LGC392MDH0M
	15,000	100 × 250	0.15	47.7	ELXR351LGC153MGR0M	4,700		76.2 × 155	0.15	21.7	ELXR451LGC472MEF5M
400	2,700	63.5 × 115	0.15	13.1	ELXR401LGC272MDB5M	5,600		76.2 × 190	0.15	26.1	ELXR451LGC562MEK0M
	3,300	63.5 × 130	0.15	15.2	ELXR401LGC332MDD0M	5,600		89 × 155	0.15	24.1	ELXR451LGC562MFF5M
	3,900	63.5 × 155	0.15	17.9	ELXR401LGC392MDF5M	6,800		89 × 170	0.15	27.8	ELXR451LGC682MFH0M
	3,900	76.2 × 115	0.15	18.2	ELXR401LGC392MEB5M	8,200	89 × 190	0.15	32.0	ELXR451LGC822MFK0M	
	4,700	63.5 × 170	0.15	20.5	ELXR401LGC472MDH0M	10,000	100 × 220	0.15	36.8	ELXR451LGC103MGN0M	
	4,700	76.2 × 130	0.15	20.1	ELXR401LGC472MED0M	12,000	100 × 250	0.15	42.7	ELXR451LGC123MGR0M	
	5,600	76.2 × 155	0.15	23.8	ELXR401LGC562MEF5M						

◆RATED RIPPLE CURRENT MULTIPLIERS

●Frequency Multipliers

Frequency (Hz)	120	300	1k	3k
Coefficient	1.0	1.1	1.3	1.4

The endurance of capacitors is reduced with internal heating produced by ripple current at the rate of halving the lifetime with every 5 to 10°C rise. When long life performance is required in actual use, the rms ripple current has to be reduced. Also, for the LXR series capacitors, using them at operating voltage less than their rated voltage can extend their lifetime. For details, please contact a representative of Nippon Chemi-Con.

Return Group Chart



LARGE CAPACITANCE ALUMINUM ELECTROLYTIC CAPACITORS

Screw terminals, 85°C

RWV Series

- For frequently change of regenerative voltage from AC servo amplifier and inverter control
- Improved the resistance for charge and discharge from same dimension of RWF series
- Endurance with ripple current : 5,000 hours at 85°C
- Rated voltage range : 350 to 450V_{dc}, Capacitance 820 to 18,000μF
- RoHS Compliant



◆ SPECIFICATIONS

Items	Characteristics						
Category	-25 to +85°C						
Temperature Range							
Rated Voltage Range	350 to 450V _{dc}						
Capacitance Tolerance	±20% (M) (at 20°C, 120Hz)						
Leakage Current	I=0.02CV or 5mA, whichever is smaller. Where, I : Max. leakage current (μA), C : Nominal capacitance (μF), V : Rated voltage (V) (at 20°C after 5 minutes)						
Dissipation Factor (tan δ)	0.25 max. (at 20°C, 120Hz)						
Low Temperature Characteristics	Capacitance change $C(-25°C)/C(+20°C) \geq 0.7$ (at 120Hz)						
Insulation Resistance	When measured between the terminals shorted each other and the mounting clamp on the insulating sleeve covering the case by using an insulation resistance meter of 500V _{dc} , the insulation resistance shall not be less than 100MΩ.						
Insulation Withstanding Voltage	When a voltage of 2,000V _{ac} is applied for 1 minute between the terminals shorted each other and the mounting clamp on the insulating sleeve covering the case, there shall not be electrical damage.						
Charge and Discharge	The following specifications shall be satisfied when the capacitors are restored to 20°C after subjected to charge and discharge test with the voltage waveform shown below at room temperature (15 to 35°C).						
	<table border="1"> <tr> <td>Capacitance change</td> <td>≤ ±20% of the initial value</td> </tr> <tr> <td>D.F. (tan δ)</td> <td>≤ 200% of the initial specified value</td> </tr> <tr> <td>Leakage current</td> <td>≤ The initial specified value</td> </tr> </table>	Capacitance change	≤ ±20% of the initial value	D.F. (tan δ)	≤ 200% of the initial specified value	Leakage current	≤ The initial specified value
Capacitance change	≤ ±20% of the initial value						
D.F. (tan δ)	≤ 200% of the initial specified value						
Leakage current	≤ The initial specified value						
	<table border="1"> <tr> <td>Frequency</td> <td>3Hz</td> </tr> <tr> <td>Number of cycles</td> <td>50 million times</td> </tr> </table>	Frequency	3Hz	Number of cycles	50 million times		
Frequency	3Hz						
Number of cycles	50 million times						
Endurance	The following specifications shall be satisfied when the capacitors are restored to 20°C after subjected to DC voltage with the rated ripple current is applied (the peak voltage shall not exceed the rated voltage) for 5,000 hours at 85°C.						
	<table border="1"> <tr> <td>Capacitance change</td> <td>≤ ±20% of the initial value</td> </tr> <tr> <td>D.F. (tan δ)</td> <td>≤ 200% of the initial specified value</td> </tr> <tr> <td>Leakage current</td> <td>≤ The initial specified value</td> </tr> </table>	Capacitance change	≤ ±20% of the initial value	D.F. (tan δ)	≤ 200% of the initial specified value	Leakage current	≤ The initial specified value
Capacitance change	≤ ±20% of the initial value						
D.F. (tan δ)	≤ 200% of the initial specified value						
Leakage current	≤ The initial specified value						
Shelf Life	The following specifications shall be satisfied when the capacitors are restored to 20°C after exposing them for 500 hours at 85°C without voltage applied. Before the measurement, the capacitor shall be preconditioned by applying voltage according to Item 4.1 of JIS C 5101-4.						
	<table border="1"> <tr> <td>Capacitance change</td> <td>≤ ±20% of the initial value</td> </tr> <tr> <td>D.F. (tan δ)</td> <td>≤ 200% of the initial specified value</td> </tr> <tr> <td>Leakage current</td> <td>≤ The initial specified value</td> </tr> </table>	Capacitance change	≤ ±20% of the initial value	D.F. (tan δ)	≤ 200% of the initial specified value	Leakage current	≤ The initial specified value
Capacitance change	≤ ±20% of the initial value						
D.F. (tan δ)	≤ 200% of the initial specified value						
Leakage current	≤ The initial specified value						

◆ DIMENSIONS (Screw-Mount) [mm]

● Terminal Code : LG

● Mounting Clamp Code : B

● Mounting Clamp Code : C

Sleeve (Pb-free PVC : Black)

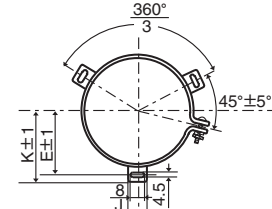
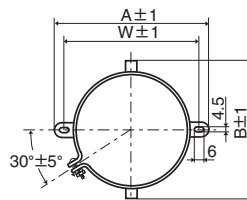
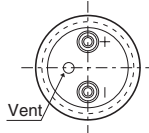
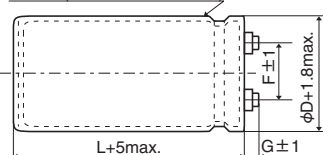

φD	A	B	W	F
50	78.0	64.0	68.0	22.4
63.5	90.0	76.0	80.0	28.0
76.2	104.5	90.0	93.5	31.5

φD	E	K	F	J
50	32.5	37.0	22.4	14.0
63.5	38.1	43.5	28.0	14.0
76.2	44.5	50.0	31.5	14.0
89	50.8	56.5	31.5	16.0

φ50 & φ63.5 : G=6
φ76.2 & φ89 : G=5

<Screw specifications>

Plus hexagon-headed screw :M5×0.8×10

Maximum screw tightening torque :3.23Nm

* The screw and the mounting clamp are separately supplied and not attached to the product.

Return Group Chart



LARGE CAPACITANCE ALUMINUM ELECTROLYTIC CAPACITORS

Screw terminals, 85°C

RWV Series

◆PART NUMBERING SYSTEM

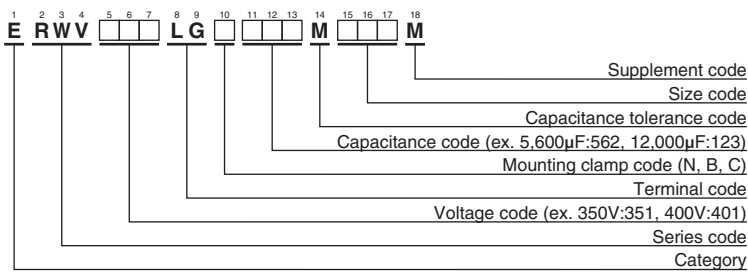

Please refer to "Product code guide (screw-mount terminal type)"

◆STANDARD RATINGS

WV (V _{dc})	Cap (μF)	Case size φD×L(mm)	Rated ripple current (Arms/85°C, 120Hz)	Max. charge current and Max. discharge current (Arms/3Hz)	Part No.	WV (V _{dc})	Cap (μF)	Case size φD×L(mm)	Rated ripple current (Arms/85°C, 120Hz)	Max. charge current and Max. discharge current (Arms/3Hz)	Part No.	
350	1,200	50 × 60	4.70	1.56	ERWV351LGC122MC60M	400	5,600	63.5 × 170	17.1	5.99	ERWV401LGC562MDH0M	
	1,500	50 × 70	5.50	1.83	ERWV351LGC152MC70M		5,600	76.2 × 105	15.2	5.35	ERWV401LGC562MEA5M	
	1,800	50 × 80	6.40	2.13	ERWV351LGC182MC80M		6,800	76.2 × 130	18.4	6.47	ERWV401LGC682MED0M	
	2,200	50 × 96	7.60	2.53	ERWV351LGC222MC96M		8,200	76.2 × 155	21.9	7.68	ERWV401LGC822MEF5M	
	2,700	50 × 105	8.80	2.94	ERWV351LGC272MCA5M		8,200	76.2 × 170	22.8	8.02	ERWV401LGC822MEH0M	
	2,700	50 × 115	9.20	3.06	ERWV351LGC272MCB5M		8,200	89 × 115	20.9	7.35	ERWV401LGC822MFB5M	
	3,300	50 × 130	10.8	3.58	ERWV351LGC332MCD0M		10,000	89 × 130	24.3	8.26	ERWV401LGC103MFD0M	
	4,700	63.5 × 115	13.2	4.61	ERWV351LGC472MDB5M		12,000	89 × 155	28.7	10.0	ERWV401LGC123MFF5M	
	5,600	63.5 × 130	15.2	5.30	ERWV351LGC562MDD0M		12,000	89 × 170	29.9	10.5	ERWV401LGC123MFH0M	
	5,600	76.2 × 105	15.2	5.36	ERWV351LGC562MEA5M		15,000	89 × 190	35.2	12.3	ERWV401LGC153MFK0M	
	6,800	63.5 × 155	18.1	6.32	ERWV351LGC682MDF5M		420	820	50 × 60	3.80	1.29	ERWV421LGC821MC60M
	8,200	63.5 × 170	20.7	7.25	ERWV351LGC822MDH0M			1,000	50 × 70	4.40	1.50	ERWV421LGC102MC70M
	8,200	76.2 × 130	20.2	6.57	ERWV351LGC822MED0M			1,200	50 × 80	5.20	1.75	ERWV421LGC122MC80M
	10,000	76.2 × 155	24.2	8.47	ERWV351LGC103MEF5M			1,800	50 × 96	6.80	2.30	ERWV421LGC182MC96M
	10,000	89 × 115	23.1	8.10	ERWV351LGC103MFB5M			1,800	50 × 105	7.10	2.40	ERWV421LGC182MCA5M
	12,000	76.2 × 170	27.6	9.66	ERWV351LGC123MEH0M			2,200	50 × 115	8.20	2.77	ERWV421LGC222MCB5M
	12,000	89 × 130	26.6	9.33	ERWV351LGC123MFD0M			2,700	50 × 130	9.60	3.25	ERWV421LGC272MCD0M
	15,000	89 × 155	32.1	11.2	ERWV351LGC153MFF5M			3,300	63.5 × 115	11.0	3.87	ERWV421LGC332MDB5M
15,000	89 × 170	33.5	11.7	ERWV351LGC153MFH0M	3,900	63.5 × 130		12.7	4.44	ERWV421LGC392MDD0M		
18,000	89 × 190	38.5	13.5	ERWV351LGC183MFK0M	4,700	63.5 × 155		15.0	5.28	ERWV421LGC472MDF5M		
375	1,000	50 × 60	4.30	1.42	ERWV3H1LGC102MC60M	4,700		76.2 × 105	13.9	4.92	ERWV421LGC472MEA5M	
	1,200	50 × 70	4.90	1.64	ERWV3H1LGC122MC70M	5,600		63.5 × 170	17.1	6.02	ERWV421LGC562MDH0M	
	1,500	50 × 80	5.80	1.94	ERWV3H1LGC152MC80M	5,600		76.2 × 130	16.6	5.90	ERWV421LGC562MED0M	
	2,200	50 × 96	7.60	2.54	ERWV3H1LGC222MC96M	6,800		76.2 × 155	19.8	7.02	ERWV421LGC682MEF5M	
	2,200	50 × 105	8.00	2.65	ERWV3H1LGC222MCA5M	6,800		89 × 115	19.0	6.73	ERWV421LGC682MFB5M	
	2,700	50 × 115	9.20	3.06	ERWV3H1LGC272MCB5M	8,200		76.2 × 170	22.7	8.04	ERWV421LGC822MEH0M	
	3,300	50 × 130	10.8	3.58	ERWV3H1LGC332MCD0M	8,200		89 × 130	22.0	7.78	ERWV421LGC822MFD0M	
	4,700	63.5 × 115	13.2	4.61	ERWV3H1LGC472MDB5M	10,000		89 × 155	26.2	9.24	ERWV421LGC103MFF5M	
	5,600	63.5 × 130	15.2	5.30	ERWV3H1LGC562MDD0M	12,000	89 × 170	29.9	10.5	ERWV421LGC123MFH0M		
	5,600	76.2 × 105	15.2	5.36	ERWV3H1LGC562MEA5M	12,000	89 × 190	31.5	11.0	ERWV421LGC123MFK0M		
	6,800	63.5 × 155	18.1	6.32	ERWV3H1LGC682MDF5M	450	820	50 × 60	3.80	1.29	ERWV451LGC821MC60M	
	6,800	63.5 × 170	18.9	6.60	ERWV3H1LGC682MDH0M		1,000	50 × 70	4.40	1.50	ERWV451LGC102MC70M	
	8,200	76.2 × 130	20.2	7.09	ERWV3H1LGC822MED0M		1,200	50 × 80	5.20	1.74	ERWV451LGC122MC80M	
	8,200	89 × 115	20.9	7.35	ERWV3H1LGC822MFB5M		1,500	50 × 96	6.20	2.10	ERWV451LGC152MC96M	
	10,000	76.2 × 155	24.2	8.48	ERWV3H1LGC103MEF5M		1,800	50 × 105	7.10	2.41	ERWV451LGC182MCA5M	
	10,000	76.2 × 170	25.2	8.85	ERWV3H1LGC103MEH0M		1,800	50 × 115	7.40	2.51	ERWV451LGC182MCB5M	
	10,000	89 × 130	24.3	8.54	ERWV3H1LGC103MFD0M		2,200	50 × 130	8.70	2.93	ERWV451LGC222MCD0M	
	12,000	89 × 155	28.7	10.0	ERWV3H1LGC123MFF5M		3,300	63.5 × 115	11.0	3.88	ERWV451LGC332MDB5M	
15,000	89 × 170	33.5	11.7	ERWV3H1LGC153MFH0M	3,900		63.5 × 130	12.7	4.44	ERWV451LGC392MDD0M		
15,000	89 × 190	35.2	12.3	ERWV3H1LGC153MFK0M	3,900		76.2 × 105	13.2	4.49	ERWV451LGC392MEA5M		
400	1,000	50 × 60	4.30	1.42	ERWV401LGC102MC60M		4,700	63.5 × 155	15.0	5.27	ERWV451LGC472MDF5M	
	1,200	50 × 70	4.90	1.64	ERWV401LGC122MC70M		4,700	63.5 × 170	15.6	5.50	ERWV451LGC472MDH0M	
	1,500	50 × 80	5.80	1.95	ERWV401LGC152MC80M		5,600	76.2 × 130	16.6	5.88	ERWV451LGC562MED0M	
	1,800	50 × 96	6.90	2.29	ERWV401LGC182MC96M		6,800	76.2 × 155	19.8	7.04	ERWV451LGC682MEF5M	
	2,200	50 × 105	8.00	2.65	ERWV401LGC222MCA5M		6,800	89 × 115	19.0	6.72	ERWV451LGC682MFB5M	
	2,200	50 × 115	8.30	2.77	ERWV401LGC222MCB5M		8,200	76.2 × 170	22.7	7.97	ERWV451LGC822MEH0M	
	2,700	50 × 130	9.80	3.23	ERWV401LGC272MCD0M		8,200	89 × 130	22.0	7.72	ERWV451LGC822MFD0M	
	3,900	63.5 × 115	12.0	4.21	ERWV401LGC392MDB5M		10,000	89 × 155	26.2	9.22	ERWV451LGC103MFF5M	
	4,700	63.5 × 130	13.9	4.86	ERWV401LGC472MDD0M	10,000	89 × 170	27.3	9.66	ERWV451LGC103MFH0M		
	5,600	63.5 × 155	16.4	5.75	ERWV401LGC562MDF5M	12,000	89 × 190	31.5	11.1	ERWV451LGC123MFK0M		

Product specifications in this catalog are subject to change without notice. Request our product specifications before purchase and/or use. Please use our products based on the information contained in this catalog and product specifications.



RWV Series

◆ RATED RIPPLE CURRENT MULTIPLIERS

● Frequency Multipliers

Frequency (Hz)	50	120	300	1k	3k
Coefficient	0.8	1.0	1.1	1.3	1.4

Note : The endurance of capacitors is shortened with internal heating produced by ripple current at the rate of halving the lifetime with every 5 to 10°C rise. When long life performance is required in actual use, the rms ripple current has to be reduced. Also, for the RWV series capacitors, using them at operating voltage less than their rated voltage can extend their lifetime. For the details, please contact a representative of Nippon Chemi-Con.



U37F Series



- Large Can
- Screw Terminals
- General Purpose U37 Grade
- High Ripple
- 350 to 500VDC Ratings
- RoHS Compliant
- 5,000 Hours Lifetime at +85°C
- Up to 150,000 Hours Useful Life



The U37F series is a general purpose, screw mount U37 grade series specifically designed to provide the ripple current capability and long life required for high reliability inverter applications. The U37F has an endurance rating of 5,000 hours at +85°C with the rated ripple current applied. The useful life can exceed 150,000 hours at +40°C and 1.5x the ripple current. These capacitors are available in a variety of high current English or Metric thread terminals. Mounting options include a three-footed clamp or bottom threaded stud. Custom designs are also available.

Summary of Specifications

- Screw terminals: high and low post, English and Metric thread.
- Capacitance range: 1,500 to 22,000µF.
- Voltage range: 350 to 500VDC.
- Category temperature range: -40°C to +85°C.
- Leakage current: 0.02CV(µA) or 5mA, whichever is smaller, after 5 minutes at +25°C.
- Standard capacitance tolerance: ±20%
- Nominal case size (D×L): D = 50mm (2.000") to 89mm (3.500"); L = 92mm (3.625") to 219mm (8.625").
- Rated lifetime: 5,000 hours at +85°C with rated ripple current applied.

Return Group Chart



LARGE CAPACITANCE ALUMINUM ELECTROLYTIC CAPACITORS (UNITED CHEMI-CON, INC. Products)

Inverter-use screw terminal, 85°C

U37F Series

U37F Specifications - Screw Terminals

Item	Characteristics																																															
Category Temperature Range	-40 to +85°C																																															
Rated Voltage Range	350 to 500VDC																																															
Capacitance Range	1,500 to 22,000μF at +25°C, 120Hz																																															
Capacitance Tolerance	±20% (M) at +25°C, 120Hz																																															
Leakage Current	$I = 0.02CV$ (μA) or 5mA, whichever is smaller, after 5 minutes at +25°C. Where I = Max. leakage current (μA), C = Nominal capacitance (μF) and V = Rated voltage (V)																																															
Rated Ripple Current Multipliers	<p>Ambient Temperature (°C)</p> <table border="1"> <tr> <td>+45°C</td> <td>+65°C</td> <td>+85°C</td> </tr> <tr> <td>2.82</td> <td>1.73</td> <td>1.00</td> </tr> </table> <p>Frequency (Hz)</p> <table border="1"> <tr> <td>DC Rated Voltage</td> <td>50Hz</td> <td>120Hz</td> <td>300Hz</td> <td>1kHz</td> <td>3kHz</td> <td>10kHz</td> </tr> <tr> <td>350-500V</td> <td>0.80</td> <td>1.00</td> <td>1.20</td> <td>1.30</td> <td>1.40</td> <td>1.41</td> </tr> </table> <p>To determine maximum ripple current at a specified temperature and frequency, use the appropriate multiplier shown.</p>	+45°C	+65°C	+85°C	2.82	1.73	1.00	DC Rated Voltage	50Hz	120Hz	300Hz	1kHz	3kHz	10kHz	350-500V	0.80	1.00	1.20	1.30	1.40	1.41																											
+45°C	+65°C	+85°C																																														
2.82	1.73	1.00																																														
DC Rated Voltage	50Hz	120Hz	300Hz	1kHz	3kHz	10kHz																																										
350-500V	0.80	1.00	1.20	1.30	1.40	1.41																																										
Endurance (Load Life)	<p>The following specifications shall be satisfied when the capacitors are restored to +25°C after subjecting them to DC voltage for 5,000 hours at +85°C with the rated ripple current applied. The sum of the DC voltage and peak AC voltage must not exceed the full rated voltage of the capacitors.</p> <p>Capacitance change: ≤ 20% from initial measurement ESR change : ≤ 200% of initial specified limit Leakage current : ≤ initial specified limit</p>																																															
Useful Life	<p>With specified standard voltage and ripple current applied, typical life as function of ambient temperature is listed below.</p> <table border="1"> <tr> <td>+85°C</td> <td>6,500 hours max.</td> <td rowspan="3"> Capacitance change: ≤ 30% from initial measurement ESR change : ≤ 300% of initial specified limit Leakage current : ≤ initial specified limit </td> </tr> <tr> <td>+65°C</td> <td>23,800 hours max.</td> </tr> <tr> <td>+45°C</td> <td>124,700 hours max.</td> </tr> </table>	+85°C	6,500 hours max.	Capacitance change: ≤ 30% from initial measurement ESR change : ≤ 300% of initial specified limit Leakage current : ≤ initial specified limit	+65°C	23,800 hours max.	+45°C	124,700 hours max.																																								
+85°C	6,500 hours max.	Capacitance change: ≤ 30% from initial measurement ESR change : ≤ 300% of initial specified limit Leakage current : ≤ initial specified limit																																														
+65°C	23,800 hours max.																																															
+45°C	124,700 hours max.																																															
Shelf Life	<p>The following specifications shall be satisfied when the capacitors are restored to +25°C after exposing them for 500 hours at +85°C without voltage applied. The rated voltage shall be applied to the capacitors for a minimum of 30 minutes, at least 24 hours and not more than 48 hours before the measurements.</p> <p>Capacitance change: ≤ 20% from initial measurement ESR change : ≤ 200% of initial specified limit Leakage current : ≤ initial specified limit</p>																																															
Vibration Rating	10-55Hz, 10g sinusoidal in three axes, 2 hours per axis.																																															
Maximum Tightening Torque	<table border="1"> <tr> <td>Terminal Code</td> <td>HP</td> <td>HL</td> <td>CD</td> <td>CP</td> <td>CH</td> <td>CA</td> <td>CS</td> </tr> <tr> <td>Thread Size</td> <td>10-32 NF-2B</td> <td>M5x0.8-6H</td> <td></td> <td>1/4-28 NF-2B</td> <td></td> <td>M6x1-6H</td> <td></td> </tr> <tr> <td>3 Threads Engaged</td> <td colspan="3">2.0 N·m (18.0 in·lb)</td> <td colspan="4">4.0 N·m (35.0 in·lb)</td> </tr> <tr> <td>6 Threads Engaged</td> <td colspan="3">2.8 N·m (25.0 in·lb)</td> <td colspan="4">6.2 N·m (55.0 in·lb)</td> </tr> </table>	Terminal Code	HP	HL	CD	CP	CH	CA	CS	Thread Size	10-32 NF-2B	M5x0.8-6H		1/4-28 NF-2B		M6x1-6H		3 Threads Engaged	2.0 N·m (18.0 in·lb)			4.0 N·m (35.0 in·lb)				6 Threads Engaged	2.8 N·m (25.0 in·lb)			6.2 N·m (55.0 in·lb)																		
Terminal Code	HP	HL	CD	CP	CH	CA	CS																																									
Thread Size	10-32 NF-2B	M5x0.8-6H		1/4-28 NF-2B		M6x1-6H																																										
3 Threads Engaged	2.0 N·m (18.0 in·lb)			4.0 N·m (35.0 in·lb)																																												
6 Threads Engaged	2.8 N·m (25.0 in·lb)			6.2 N·m (55.0 in·lb)																																												
Typical Inductance (nH) at 1MHz	<table border="1"> <tr> <td rowspan="2">Case Diameter (mm)</td> <td colspan="7">Terminal Code</td> </tr> <tr> <td>HP</td> <td>HL</td> <td>CD</td> <td>CP</td> <td>CH</td> <td>CA</td> <td>CS</td> </tr> <tr> <td>∅50.8</td> <td>—</td> <td>—</td> <td>NA</td> <td>NA</td> <td>NA</td> <td>NA</td> <td>NA</td> </tr> <tr> <td>∅63.5</td> <td>—</td> <td>—</td> <td>—</td> <td>—</td> <td>—</td> <td>—</td> <td>—</td> </tr> <tr> <td>∅76.2</td> <td>30</td> <td>30</td> <td>25</td> <td>20</td> <td>25</td> <td>20</td> <td>25</td> </tr> <tr> <td>∅89.0</td> <td>30</td> <td>30</td> <td>25</td> <td>20</td> <td>25</td> <td>20</td> <td>25</td> </tr> </table>	Case Diameter (mm)	Terminal Code							HP	HL	CD	CP	CH	CA	CS	∅50.8	—	—	NA	NA	NA	NA	NA	∅63.5	—	—	—	—	—	—	—	∅76.2	30	30	25	20	25	20	25	∅89.0	30	30	25	20	25	20	25
Case Diameter (mm)	Terminal Code																																															
	HP	HL	CD	CP	CH	CA	CS																																									
∅50.8	—	—	NA	NA	NA	NA	NA																																									
∅63.5	—	—	—	—	—	—	—																																									
∅76.2	30	30	25	20	25	20	25																																									
∅89.0	30	30	25	20	25	20	25																																									
Custom Designs	Custom CV values per case size and termination type may be available upon request. Contact appropriate representative with specific requirements.																																															

Return Group Chart



LARGE CAPACITANCE ALUMINUM ELECTROLYTIC CAPACITORS (UNITED CHEMI-CON, INC. Products)

Inverter-use screw terminal, 85°C

U37F Series

U37F Useful Life

Useful Life: 6,500 Hours at +85°C

The life expectancy of a capacitor is shown as a function of ambient temperature and ripple current load.

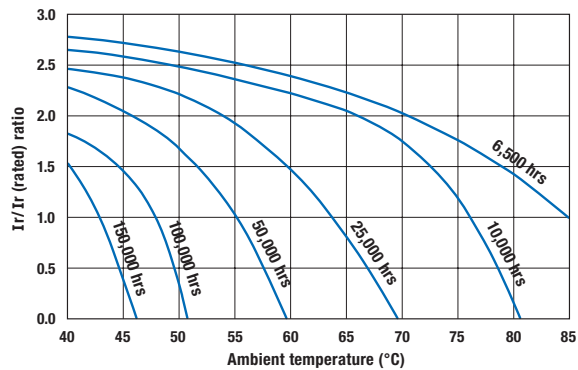
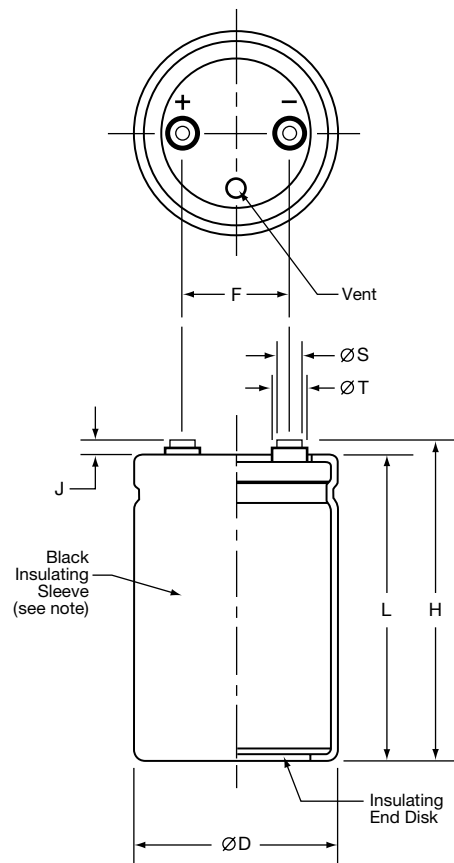

Diagram of Dimensions - Screw Terminals

Large Can/Screw Terminals

Unit: mm (inches)



Case Dimensions and Standard Box Quantities

Case Size Code	ØD +2.0 (0.080)	L ±1.0 (0.040)	F ±0.25 (0.010)	Standard Box Quantity
CB7 CD0	50.8 (2.000)	117 (4.625) 130 (5.125)	22.2 (0.875)	49
D92 DA5 DB7 DD0 DE3	63.5 (2.500)	92 (3.625) 105 (4.125) 117 (4.625) 130 (5.125) 143 (5.625)	28.6 (1.125)	20
E92 EA5 EB7 EE3 EJ1 EM9	76.2 (3.000)	92 (3.625) 105 (4.125) 117 (4.625) 143 (5.625) 181 (7.125) 219 (8.625)	31.8 (1.250)	16 9
F92 FA5 FB7 FE3 FF5 FK0 FM9	89.0 (3.500)	92 (3.625) 105 (4.125) 117 (4.625) 143 (5.625) 155 (6.125) 190 (7.500) 219 (8.625)	31.8 (1.250)	5

Note:

In some cases, the color of the sleeve may change slightly due to the operating conditions, however, the discoloration will not impair capacitor function.

Terminal Specifications

Terminal Code	Available Case Diameter		Thread Size	Minimum Thread Depth	J ±0.5 (0.020)	H ±2.0 (0.080)	ØS ±0.25 (0.010)	ØT ±0.25 (0.010)
	ØD Code	ØD mm (inches)						
HP	C	50.8 (2.000)	10-32 NF-2B	9.5 (0.375)	6.4 (0.250)	L+J	8.0 (0.313)	11.1 (0.438)
HL	C	50.8 (2.000)	M5x0.8-6H	9.5 (0.375)	6.4 (0.250)	L+J	8.0 (0.313)	11.1 (0.438)
CD	D-E	63.5 - 76.2 (2.500 - 3.000)	M5x0.8-6H	8.5 (0.335)	5.0 (0.200)	L+J	13.0 (0.512)	18.8 (0.740)
CP	D-F	63.5 - 89.0 (2.500 - 3.500)	¼-28 NF-2B	8.7 (0.344)	2.4 (0.093)	L+J	17.5 (0.689)	—
CH	D-F	63.5 - 89.0 (2.500 - 3.500)	¼-28 NF-2B	11.9 (0.468)	6.4 (0.250)	L+J	17.5 (0.689)	—
CA	D-F	63.5 - 89.0 (2.500 - 3.500)	M6x1-6H	8.7 (0.344)	2.4 (0.093)	L+J	17.5 (0.689)	—
CS	D-F	63.5 - 89.0 (2.500 - 3.500)	M6x1-6H	11.9 (0.468)	6.4 (0.250)	L+J	17.5 (0.689)	—

Mounting Hardware is optional. Refer to hardware specifications on the following page.

Return Group Chart



LARGE CAPACITANCE ALUMINUM ELECTROLYTIC CAPACITORS (UNITED CHEMI-CON, INC. Products)

Inverter-use screw terminal, 85°C

U37F Series

Mounting Hardware - Screw Terminals

Type C: Three-Footed Clamp

Unit: mm (inches)

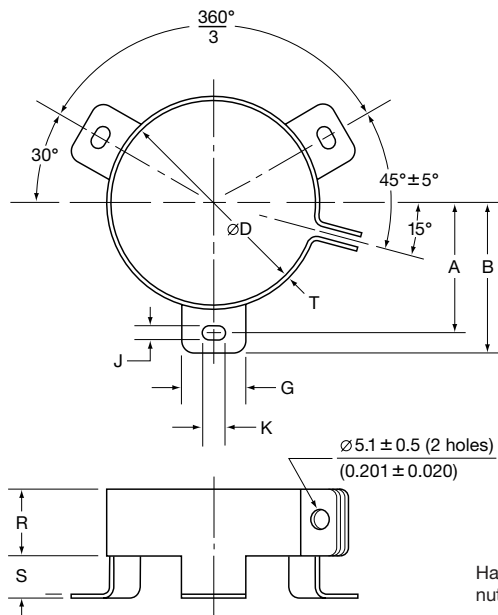

Hardware: Screw, washer and hexagon nut included with each clamp.

Type C: Clamp Dimensions

Mounting Code	Case ØD	A ±1.0 (0.040)	B ±1.0 (0.040)	G ±1.0 (0.040)	J ±0.5 (0.020)	K ±0.5 (0.020)	R ±1.0 (0.040)	S ±1.0 (0.040)	T ±0.5 (0.020)
C	50.8 (2.000)	31.8 (1.250)	36.5 (1.437)	13.3 (0.524)	4.5 (0.177)	7.1 (0.280)	19.1 (0.751)	9.5 (0.374)	0.8 (0.032)
C	63.5 (2.500)	38.1 (1.500)	42.9 (1.689)	13.3 (0.524)	4.5 (0.177)	7.1 (0.280)	19.1 (0.751)	9.5 (0.374)	0.8 (0.032)
C	76.2 (3.000)	44.5 (1.750)	49.2 (1.937)	13.3 (0.524)	4.5 (0.177)	7.1 (0.280)	19.1 (0.751)	9.5 (0.374)	1.0 (0.040)
C	89.0 (3.500)	50.8 (2.000)	56.5 (2.224)	16.0 (0.630)	4.5 (0.177)	8.0 (0.313)	21.0 (0.827)	9.0 (0.354)	1.0 (0.040)

Type S: Stud Mounting

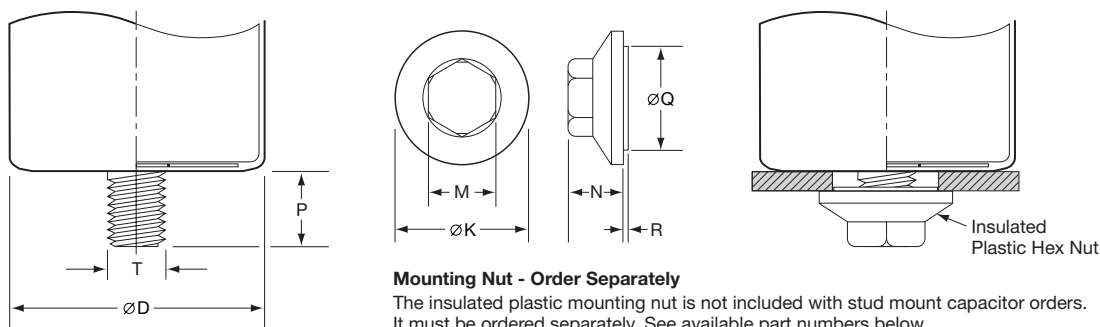

Mounting Nut - Order Separately

The insulated plastic mounting nut is not included with stud mount capacitor orders. It must be ordered separately. See available part numbers below.

Type S: Stud Dimensions

Mounting Code	P ±1.0 (0.040)	T Thread Size
S	16.0 (0.630)	M12

Mounting Nut Dimensions

Part Number	ØK ±2.0 (0.080)	M ±1.0 (0.040)	N ±1.0 (0.040)	ØQ ±1.0 (0.040)	R ±1.0 (0.040)
50-8D	30.0 (1.181)	19.0 (0.748)	18.0 (0.709)	22.0 (0.866)	1.40 (0.055)
50-8E	38.0 (1.496)	19.0 (0.748)	18.0 (0.709)	30.0 (1.181)	1.40 (0.055)



U37F Series

Part Numbering System for U37F Series When ordering, always specify complete 18-field global part number.

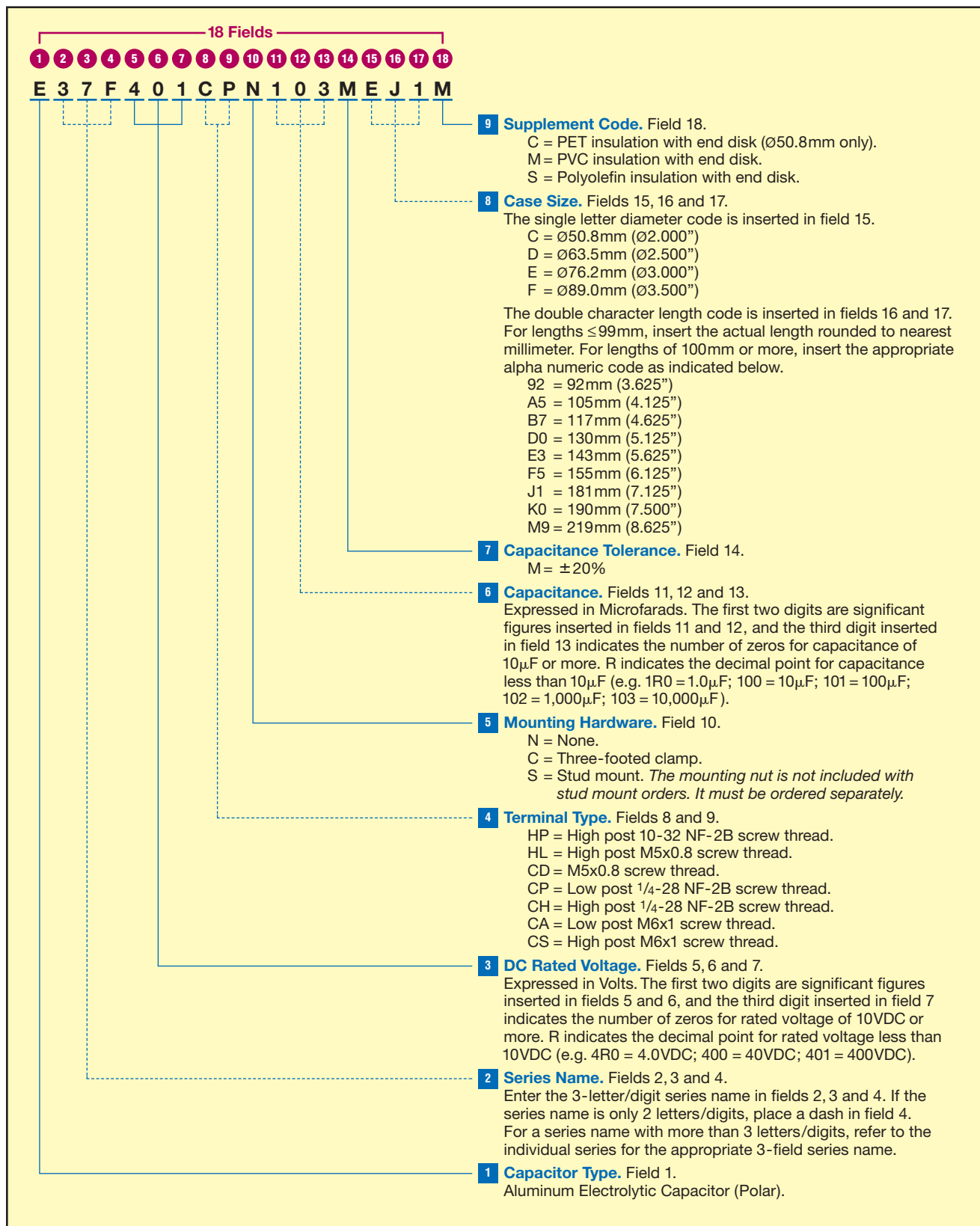

Return Group Chart



LARGE CAPACITANCE ALUMINUM ELECTROLYTIC CAPACITORS (UNITED CHEMI-CON, INC. Products)

Inverter-use screw terminal, 85°C

U37F Series

Standard Voltage Ratings - Screw Terminals

Rated Voltage (WVDC)	Capacitance (μF)	Global Part Number†	Nominal Case Size* D × L (mm)	Case Size Code	Maximum ESR (mΩ) at +25°C, 120Hz	Rated Ripple Current (A rms) at +85°C		
						120Hz	300Hz	>3kHz
350 Volts 400 Volts Surge	3,300	E37F351HPN332MCB7M	50 × 117	CB7	28	10.8	12.9	15.1
	3,900	E37F351HPN392MCD0M	50 × 130	CD0	23	12.2	14.6	17.0
	3,300	E37F351CPN332MD92M	63.5 × 92	D92	28	11.2	13.4	15.6
	3,900	E37F351CPN392MDA5M	63.5 × 105	DA5	23	12.7	15.2	17.7
	4,700	E37F351CPN472MDB7M	63.5 × 117	DB7	19	14.5	17.4	20.3
	5,600	E37F351CPN562MDD0M	63.5 × 130	DD0	16	16.4	19.7	22.9
	5,600	E37F351CPN562MDE3M	63.5 × 143	DE3	16	17.0	20.4	23.7
	4,700	E37F351CPN472ME92M	76.2 × 92	E92	20	14.5	17.4	20.2
	5,600	E37F351CPN562MEA5M	76.2 × 105	EA5	17	16.5	19.8	23.1
	6,800	E37F351CPN682MEB7M	76.2 × 117	EB7	14	18.9	22.6	26.4
	8,200	E37F351CPN822MEE3M	76.2 × 143	EE3	12	22.2	26.7	31.1
	12,000	E37F351CPN123MEJ1M	76.2 × 181	EJ1	8	29.4	35.2	41.1
	15,000	E37F351CPN153MEM9M	76.2 × 219	EM9	6	35.4	42.5	49.6
	6,800	E37F351CPN682MF92M	89 × 92	F92	14	19.1	22.9	26.7
	8,200	E37F351CPN822MFA5M	89 × 105	FA5	12	21.8	26.2	30.5
	10,000	E37F351CPN103MFB7M	89 × 117	FB7	10	25.0	30.0	35.0
	12,000	E37F351CPN123MFE3M	89 × 143	FE3	8	29.3	35.2	41.1
	15,000	E37F351CPN153MFF5M	89 × 155	FF5	6	33.8	40.5	47.3
18,000	E37F351CPN183MFK0M	89 × 190	FK0	5	40.0	47.9	55.9	
22,000	E37F351CPN223MFM9M	89 × 219	FM9	4	46.7	56.0	65.4	
400 Volts 450 Volts Surge	2,700	E37F401HPN272MCB7M	50 × 117	CB7	30	10.4	12.5	14.6
	3,300	E37F401HPN332MCD0M	50 × 130	CD0	26	11.6	13.9	16.2
	2,700	E37F401CPN272MD92M	63.5 × 92	D92	30	10.7	12.9	15.0
	3,300	E37F401CPN332MDA5M	63.5 × 105	DA5	25	12.3	14.7	17.2
	3,900	E37F401CPN392MDB7M	63.5 × 117	DB7	21	13.8	16.5	19.3
	4,700	E37F401CPN472MDD0M	63.5 × 130	DD0	19	15.3	18.3	21.4
	4,700	E37F401CPN472MDE3M	63.5 × 143	DE3	17	16.8	20.1	23.5
	3,900	E37F401CPN392ME92M	76.2 × 92	E92	21	14.3	17.2	20.0
	5,600	E37F401CPN562MEA5M	76.2 × 105	EA5	17	16.4	19.6	22.9
	5,600	E37F401CPN562MEB7M	76.2 × 117	EB7	15	18.4	22.0	25.7
	8,200	E37F401CPN822MEE3M	76.2 × 143	EE3	12	22.3	26.8	31.3
	10,000	E37F401CPN103MEJ1M	76.2 × 181	EJ1	9	28.2	33.8	39.5
	12,000	E37F401CPN123MEM9M	76.2 × 219	EM9	7	34.0	40.8	47.6
	5,600	E37F401CPN562MF92M	89 × 92	F92	15	18.6	22.3	26.1
	6,800	E37F401CPN682MFA5M	89 × 105	FA5	12	21.2	25.5	29.7
	8,200	E37F401CPN822MFB7M	89 × 117	FB7	11	23.8	28.6	33.4
	10,000	E37F401CPN103MFE3M	89 × 143	FE3	8	28.9	34.7	40.5
	12,000	E37F401CPN123MFF5M	89 × 155	FF5	7	31.4	37.7	44.0
15,000	E37F401CPN153MFK0M	89 × 190	FK0	6	38.3	45.9	53.6	
18,000	E37F401CPN183MFM9M	89 × 219	FM9	5	43.9	52.7	61.5	
420 Volts 470 Volts Surge	2,700	E37F421HPN272MCB7M	50 × 117	CB7	34	9.8	11.7	13.7
	3,300	E37F421HPN332MCD0M	50 × 130	CD0	28	11.2	13.4	15.7
	2,700	E37F421CPN272MD92M	63.5 × 92	D92	34	10.1	12.1	14.1
	3,300	E37F421CPN332MDA5M	63.5 × 105	DA5	28	11.7	14.0	16.3
	3,900	E37F421CPN392MDB7M	63.5 × 117	DB7	23	13.2	15.8	18.5
	3,900	E37F421CPN392MDD0M	63.5 × 130	DD0	23	13.7	16.4	19.1
	4,700	E37F421CPN472MDE3M	63.5 × 143	DE3	19	15.5	18.6	21.8
	3,900	E37F421CPN392ME92M	76.2 × 92	E92	24	13.2	15.8	18.4
	4,700	E37F421CPN472MEA5M	76.2 × 105	EA5	20	15.1	18.1	21.1
	5,600	E37F421CPN562MEB7M	76.2 × 117	EB7	17	17.1	20.5	24.0
	6,800	E37F421CPN682MEE3M	76.2 × 143	EE3	14	20.2	24.3	28.3
	10,000	E37F421CPN103MEJ1M	76.2 × 181	EJ1	10	26.8	32.2	37.5
	12,000	E37F421CPN123MEM9M	76.2 × 219	EM9	8	31.7	38.0	44.4
	5,600	E37F421CPN562MF92M	89 × 92	F92	17	17.3	20.8	24.2
	6,800	E37F421CPN682MFA5M	89 × 105	FA5	14	19.9	23.8	27.8

† For terminal, mounting and construction options, refer to the part numbering system for descriptions and codes.

* Refer to diagram of dimensions for detailed case size specifications.

Return Group Chart



LARGE CAPACITANCE ALUMINUM ELECTROLYTIC CAPACITORS (UNITED CHEMI-CON, INC. Products)

Inverter-use screw terminal, 85°C

U37F Series

Standard Voltage Ratings - Screw Terminals

Rated Voltage (WVDC)	Capacitance (μF)	Global Part Number†	Nominal Case Size* D × L (mm)	Case Size Code	Maximum ESR (mΩ) at +25°C, 120Hz	Rated Ripple Current (A rms) at +85°C		
						120Hz	300Hz	>3kHz
420 Volts 470 Volts Surge	8,200	E37F421CPN822MFB7M	89 × 117	FB7	12	22.7	27.2	31.7
	10,000	E37F421CPN103MFE3M	89 × 143	FE3	10	26.8	32.1	37.5
	12,000	E37F421CPN123MFF5M	89 × 155	FF5	8	30.3	36.3	42.4
	15,000	E37F421CPN153MFK0M	89 × 190	FK0	6	36.5	43.8	51.1
	18,000	E37F421CPN183MFM9M	89 × 219	FM9	5	42.2	50.7	59.1
450 Volts 500 Volts Surge	2,700	E37F451HPN272MCB7M	50 × 117	CB7	34	9.8	11.7	13.7
	2,700	E37F451HPN272MCD0M	50 × 130	CD0	34	10.1	12.1	14.2
	2,200	E37F451CPN222MD92M	63.5 × 92	D92	42	9.1	10.9	12.8
	2,700	E37F451CPN272MDA5M	63.5 × 105	DA5	34	10.5	12.7	14.8
	3,300	E37F451CPN332MDB7M	63.5 × 117	DB7	28	12.1	14.6	17.0
	3,900	E37F451CPN392MDD0M	63.5 × 130	DD0	23	13.7	16.4	19.1
	4,700	E37F451CPN472MDE3M	63.5 × 143	DE3	19	15.5	18.6	21.8
	3,900	E37F451CPN392ME92M	76.2 × 92	E92	24	13.2	15.8	18.4
	4,700	E37F451CPN472MEA5M	76.2 × 105	EA5	20	15.1	18.1	21.1
	5,600	E37F451CPN562MEB7M	76.2 × 117	EB7	17	17.1	20.5	24.0
	6,800	E37F451CPN682MEE3M	76.2 × 143	EE3	14	20.2	24.3	28.3
	8,200	E37F451CPN822MEJ1M	76.2 × 181	EJ1	12	24.3	29.1	34.0
	12,000	E37F451CPN123MEM9M	76.2 × 219	EM9	8	31.7	38.0	44.4
	5,600	E37F451CPN562MF92M	89 × 92	F92	17	17.3	20.8	24.2
	6,800	E37F451CPN682MFA5M	89 × 105	FA5	14	19.9	23.8	27.8
	6,800	E37F451CPN682MFB7M	89 × 117	FB7	14	20.6	24.8	28.9
	8,200	E37F451CPN822MFE3M	89 × 143	FE3	12	24.3	29.1	34.0
	12,000	E37F451CPN123MFF5M	89 × 155	FF5	8	30.2	36.3	42.3
	15,000	E37F451CPN153MFK0M	89 × 190	FK0	6	36.5	43.8	51.1
	15,000	E37F451CPN153MFM9M	89 × 219	FM9	6	38.6	46.3	54.0
500 Volts 550 Volts Surge	1,500	E37F501HPN152MCB7M	50 × 117	CB7	63	7.2	8.6	10.1
	1,800	E37F501HPN182MCD0M	50 × 130	CD0	55	8.0	9.6	11.2
	1,800	E37F501CPN182MD92M	63.5 × 92	D92	52	8.2	9.8	11.5
	2,200	E37F501CPN222MDA5M	63.5 × 105	DA5	43	9.4	11.2	13.1
	2,700	E37F501CPN272MDB7M	63.5 × 117	DB7	37	10.5	12.6	14.7
	3,300	E37F501CPN332MDD0M	63.5 × 130	DD0	32	11.7	14.0	16.3
	3,300	E37F501CPN332MDE3M	63.5 × 143	DE3	29	12.8	15.4	17.9
	2,700	E37F501CPN272ME92M	76.2 × 92	E92	36	10.9	13.1	15.3
	3,300	E37F501CPN332MEA5M	76.2 × 105	EA5	30	12.5	15.0	17.5
	3,900	E37F501CPN392MEB7M	76.2 × 117	EB7	25	14.0	16.8	19.6
	5,600	E37F501CPN562MEE3M	76.2 × 143	EE3	20	17.1	20.5	23.9
	6,800	E37F501CPN682MEJ1M	76.2 × 181	EJ1	15	21.5	25.8	30.1
	8,200	E37F501CPN822MEM9M	76.2 × 219	EM9	12	26.0	31.2	36.3
	3,900	E37F501CPN392MF92M	89 × 92	F92	25	14.2	17.1	19.9
	4,700	E37F501CPN472MFA5M	89 × 105	FA5	21	16.2	19.5	22.7
	5,600	E37F501CPN562MFB7M	89 × 117	FB7	18	18.2	21.8	25.5
	6,800	E37F501CPN682MFE3M	89 × 143	FE3	14	22.1	26.5	30.9
	8,200	E37F501CPN822MFF5M	89 × 155	FF5	13	24.0	28.8	33.6
	10,000	E37F501CPN103MFK0M	89 × 190	FK0	10	29.2	35.1	40.9
	12,000	E37F501CPN123MFM9M	89 × 219	FM9	8	33.5	40.2	46.9

†For terminal, mounting and construction options, refer to the part numbering system for descriptions and codes.

*Refer to diagram of dimensions for detailed case size specifications.



U37L Series



- Large Can
- Screw Terminals
- General Purpose U37 Grade
- High Ripple
- 350 to 500VDC Ratings
- RoHS Compliant
- 10,000 Hours Lifetime at +85°C
- Up to 175,000 Hours Useful Life



The U37L series is a longer life version of the U37 grade series and is specifically designed to provide the ripple current capability and long life required for high reliability inverter applications. The U37L has an endurance rating of 10,000 hours at +85°C with the rated ripple current applied. The useful life can exceed 175,000 hours at +40°C and 2x the ripple current. These capacitors are available in a variety of high current English or Metric thread terminals. Mounting options include a three-footed clamp or bottom threaded stud. Custom designs are also available.

Summary of Specifications

- Screw terminals: high and low post, English and Metric thread.
- Capacitance range: 1,500 to 18,000µF.
- Voltage range: 350 to 500VDC.
- Category temperature range: -40°C to +85°C.
- Leakage current: 0.02CV(µA) or 5mA, whichever is smaller, after 5 minutes at +25°C.
- Standard capacitance tolerance: ±20%
- Nominal case size (D×L): D = 50mm (2.000") to 89mm (3.500"); L = 92mm (3.625") to 219mm (8.625").
- Rated lifetime: 10,000 hours at +85°C with rated ripple current applied.

Return Group Chart



LARGE CAPACITANCE ALUMINUM ELECTROLYTIC CAPACITORS (UNITED CHEMI-CON, INC. Products)

Inverter-use screw terminal, 85°C

U37L Series

U37L Specifications - Screw Terminals

Item	Characteristics																																															
Category Temperature Range	- 40 to +85°C																																															
Rated Voltage Range	350 to 500VDC																																															
Capacitance Range	1,500 to 18,000μF at +25°C, 120Hz																																															
Capacitance Tolerance	±20% (M) at +25°C, 120Hz																																															
Leakage Current	I = 0.02CV (μA) or 5mA, whichever is smaller, after 5 minutes at +25°C. Where I = Max. leakage current (μA), C = Nominal capacitance (μF) and V = Rated voltage (V)																																															
Rated Ripple Current Multipliers	Ambient Temperature (°C) <table border="1"> <tr> <td>+45°C</td> <td>+65°C</td> <td>+85°C</td> </tr> <tr> <td>2.82</td> <td>1.73</td> <td>1.00</td> </tr> </table> Frequency (Hz) <table border="1"> <tr> <td>DC Rated Voltage</td> <td>50Hz</td> <td>120Hz</td> <td>300Hz</td> <td>1kHz</td> <td>3kHz</td> <td>10kHz</td> </tr> <tr> <td>350-500V</td> <td>0.80</td> <td>1.00</td> <td>1.20</td> <td>1.30</td> <td>1.40</td> <td>1.41</td> </tr> </table> To determine maximum ripple current at a specified temperature and frequency, use the appropriate multiplier shown.	+45°C	+65°C	+85°C	2.82	1.73	1.00	DC Rated Voltage	50Hz	120Hz	300Hz	1kHz	3kHz	10kHz	350-500V	0.80	1.00	1.20	1.30	1.40	1.41																											
+45°C	+65°C	+85°C																																														
2.82	1.73	1.00																																														
DC Rated Voltage	50Hz	120Hz	300Hz	1kHz	3kHz	10kHz																																										
350-500V	0.80	1.00	1.20	1.30	1.40	1.41																																										
Endurance (Load Life)	The following specifications shall be satisfied when the capacitors are restored to +25°C after subjecting them to DC voltage for 10,000 hours at +85°C with the rated ripple current applied. The sum of the DC voltage and peak AC voltage must not exceed the full rated voltage of the capacitors. Capacitance change: ≤ 20% from initial measurement ESR change : ≤ 200% of initial specified limit Leakage current : ≤ initial specified limit																																															
Useful Life	With specified standard voltage and ripple current applied, typical life as function of ambient temperature is listed below. <table border="1"> <tr> <td>+85°C</td> <td>13,000 hours max.</td> </tr> <tr> <td>+65°C</td> <td>47,700 hours max.</td> </tr> <tr> <td>+45°C</td> <td>175,000 hours max.</td> </tr> </table> Capacitance change: ≤ 30% from initial measurement ESR change : ≤ 300% of initial specified limit Leakage current : ≤ initial specified limit	+85°C	13,000 hours max.	+65°C	47,700 hours max.	+45°C	175,000 hours max.																																									
+85°C	13,000 hours max.																																															
+65°C	47,700 hours max.																																															
+45°C	175,000 hours max.																																															
Shelf Life	The following specifications shall be satisfied when the capacitors are restored to +25°C after exposing them for 500 hours at +85°C without voltage applied. The rated voltage shall be applied to the capacitors for a minimum of 30 minutes, at least 24 hours and not more than 48 hours before the measurements. Capacitance change: ≤ 20% from initial measurement ESR change : ≤ 200% of initial specified limit Leakage current : ≤ initial specified limit																																															
Vibration Rating	10-55Hz, 10g sinusoidal in three axes, 2 hours per axis.																																															
Maximum Tightening Torque	<table border="1"> <tr> <td>Terminal Code</td> <td>HP</td> <td>HL</td> <td>CD</td> <td>CP</td> <td>CH</td> <td>CA</td> <td>CS</td> </tr> <tr> <td>Thread Size</td> <td>10-32 NF-2B</td> <td>M5x0.8-6H</td> <td></td> <td>1/4-28 NF-2B</td> <td></td> <td>M6x1-6H</td> <td></td> </tr> <tr> <td>3 Threads Engaged</td> <td colspan="3">2.0 N·m (18.0 in·lb)</td> <td colspan="4">4.0 N·m (35.0 in·lb)</td> </tr> <tr> <td>6 Threads Engaged</td> <td colspan="3">2.8 N·m (25.0 in·lb)</td> <td colspan="4">6.2 N·m (55.0 in·lb)</td> </tr> </table>	Terminal Code	HP	HL	CD	CP	CH	CA	CS	Thread Size	10-32 NF-2B	M5x0.8-6H		1/4-28 NF-2B		M6x1-6H		3 Threads Engaged	2.0 N·m (18.0 in·lb)			4.0 N·m (35.0 in·lb)				6 Threads Engaged	2.8 N·m (25.0 in·lb)			6.2 N·m (55.0 in·lb)																		
Terminal Code	HP	HL	CD	CP	CH	CA	CS																																									
Thread Size	10-32 NF-2B	M5x0.8-6H		1/4-28 NF-2B		M6x1-6H																																										
3 Threads Engaged	2.0 N·m (18.0 in·lb)			4.0 N·m (35.0 in·lb)																																												
6 Threads Engaged	2.8 N·m (25.0 in·lb)			6.2 N·m (55.0 in·lb)																																												
Typical Inductance (nH) at 1MHz	<table border="1"> <tr> <td rowspan="2">Case Diameter (mm)</td> <td colspan="7">Terminal Code</td> </tr> <tr> <td>HP</td> <td>HL</td> <td>CD</td> <td>CP</td> <td>CH</td> <td>CA</td> <td>CS</td> </tr> <tr> <td>∅50.8</td> <td>—</td> <td>—</td> <td>NA</td> <td>NA</td> <td>NA</td> <td>NA</td> <td>NA</td> </tr> <tr> <td>∅63.5</td> <td>—</td> <td>—</td> <td>—</td> <td>—</td> <td>—</td> <td>—</td> <td>—</td> </tr> <tr> <td>∅76.2</td> <td>30</td> <td>30</td> <td>25</td> <td>20</td> <td>25</td> <td>20</td> <td>25</td> </tr> <tr> <td>∅89.0</td> <td>30</td> <td>30</td> <td>25</td> <td>20</td> <td>25</td> <td>20</td> <td>25</td> </tr> </table>	Case Diameter (mm)	Terminal Code							HP	HL	CD	CP	CH	CA	CS	∅50.8	—	—	NA	NA	NA	NA	NA	∅63.5	—	—	—	—	—	—	—	∅76.2	30	30	25	20	25	20	25	∅89.0	30	30	25	20	25	20	25
Case Diameter (mm)	Terminal Code																																															
	HP	HL	CD	CP	CH	CA	CS																																									
∅50.8	—	—	NA	NA	NA	NA	NA																																									
∅63.5	—	—	—	—	—	—	—																																									
∅76.2	30	30	25	20	25	20	25																																									
∅89.0	30	30	25	20	25	20	25																																									
Custom Designs	Custom CV values per case size and termination type may be available upon request. Contact appropriate representative with specific requirements.																																															

Return Group Chart



LARGE CAPACITANCE ALUMINUM ELECTROLYTIC CAPACITORS (UNITED CHEMI-CON, INC. Products)

Inverter-use screw terminal, 85°C

U37L Series

U37L Useful Life

Useful Life: 13,000 Hours at +85°C

The life expectancy of a capacitor is shown as a function of ambient temperature and ripple current load.

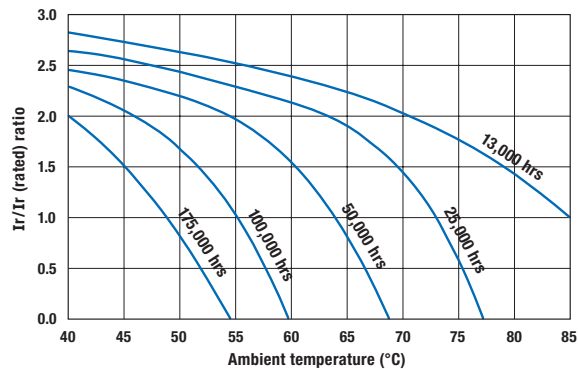
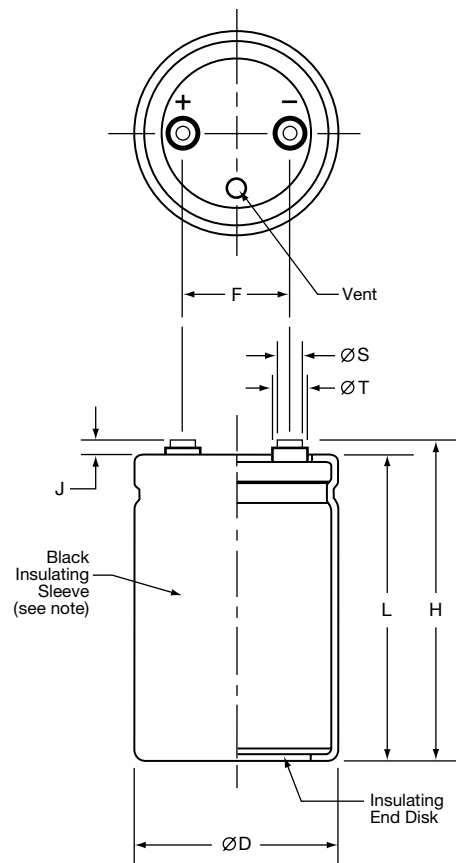

Diagram of Dimensions - Screw Terminals

Large Can/Screw Terminals

Unit: mm (inches)



Case Dimensions and Standard Box Quantities

Case Size Code	ØD +2.0 (0.080)	L ±1.0 (0.040)	F ±0.25 (0.010)	Standard Box Quantity
CB7 CD0	50.8 (2.000)	117 (4.625) 130 (5.125)	22.2 (0.875)	49
D92 DA5 DB7 DD0 DE3	63.5 (2.500)	92 (3.625) 105 (4.125) 117 (4.625) 130 (5.125) 143 (5.625)	28.6 (1.125)	20
E92 EA5 EB7 EE3 EJ1 EM9	76.2 (3.000)	92 (3.625) 105 (4.125) 117 (4.625) 143 (5.625) 181 (7.125) 219 (8.625)	31.8 (1.250)	16 9
F92 FA5 FB7 FE3 FF5 FK0 FM9	89.0 (3.500)	92 (3.625) 105 (4.125) 117 (4.625) 143 (5.625) 155 (6.125) 190 (7.500) 219 (8.625)	31.8 (1.250)	5

Note:

In some cases, the color of the sleeve may change slightly due to the operating conditions, however, the discoloration will not impair capacitor function.

Terminal Specifications

Terminal Code	Available Case Diameter		Thread Size	Minimum Thread Depth	J ±0.5 (0.020)	H ±2.0 (0.080)	ØS ±0.25 (0.010)	ØT ±0.25 (0.010)
	ØD Code	ØD mm (inches)						
HP	C	50.8 (2.000)	10-32 NF-2B	9.5 (0.375)	6.4 (0.250)	L+J	8.0 (0.313)	11.1 (0.438)
HL	C	50.8 (2.000)	M5x0.8-6H	9.5 (0.375)	6.4 (0.250)	L+J	8.0 (0.313)	11.1 (0.438)
CD	D-E	63.5 - 76.2 (2.500 - 3.000)	M5x0.8-6H	8.5 (0.335)	5.0 (0.200)	L+J	13.0 (0.512)	18.8 (0.740)
CP	D-F	63.5 - 89.0 (2.500 - 3.500)	¼-28 NF-2B	8.7 (0.344)	2.4 (0.093)	L+J	17.5 (0.689)	—
CH	D-F	63.5 - 89.0 (2.500 - 3.500)	¼-28 NF-2B	11.9 (0.468)	6.4 (0.250)	L+J	17.5 (0.689)	—
CA	D-F	63.5 - 89.0 (2.500 - 3.500)	M6x1-6H	8.7 (0.344)	2.4 (0.093)	L+J	17.5 (0.689)	—
CS	D-F	63.5 - 89.0 (2.500 - 3.500)	M6x1-6H	11.9 (0.468)	6.4 (0.250)	L+J	17.5 (0.689)	—

Mounting Hardware is optional. Refer to hardware specifications on the following page.



U37L Series

Mounting Hardware - Screw Terminals

Type C: Three-Footed Clamp

Unit: mm (inches)

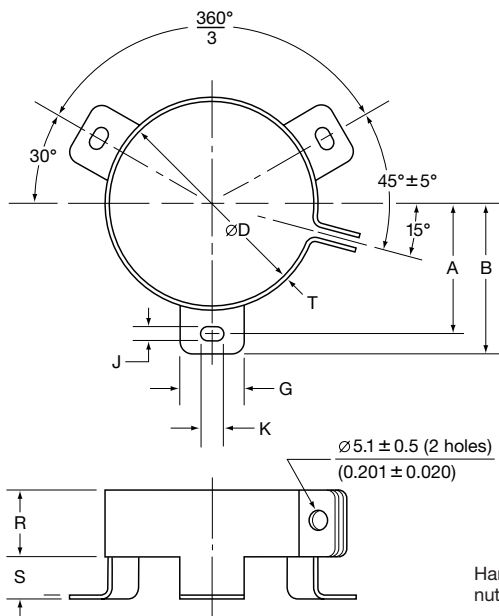

Hardware: Screw, washer and hexagon nut included with each clamp.

Type C: Clamp Dimensions

Mounting Code	Case $\varnothing D$	A ± 1.0 (0.040)	B ± 1.0 (0.040)	G ± 1.0 (0.040)	J ± 0.5 (0.020)	K ± 0.5 (0.020)	R ± 1.0 (0.040)	S ± 1.0 (0.040)	T ± 0.5 (0.020)
C	50.8 (2.000)	31.8 (1.250)	36.5 (1.437)	13.3 (0.524)	4.5 (0.177)	7.1 (0.280)	19.1 (0.751)	9.5 (0.374)	0.8 (0.032)
C	63.5 (2.500)	38.1 (1.500)	42.9 (1.689)	13.3 (0.524)	4.5 (0.177)	7.1 (0.280)	19.1 (0.751)	9.5 (0.374)	0.8 (0.032)
C	76.2 (3.000)	44.5 (1.750)	49.2 (1.937)	13.3 (0.524)	4.5 (0.177)	7.1 (0.280)	19.1 (0.751)	9.5 (0.374)	1.0 (0.040)
C	89.0 (3.500)	50.8 (2.000)	56.5 (2.224)	16.0 (0.630)	4.5 (0.177)	8.0 (0.313)	21.0 (0.827)	9.0 (0.354)	1.0 (0.040)

Type S: Stud Mounting

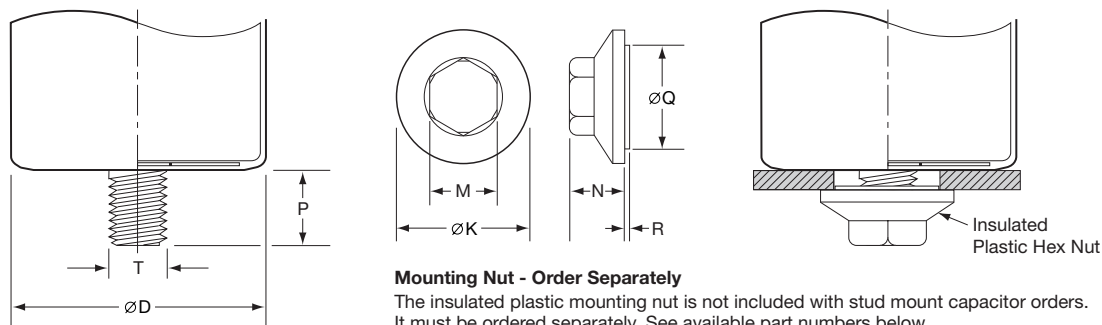

Mounting Nut - Order Separately

The insulated plastic mounting nut is not included with stud mount capacitor orders. It must be ordered separately. See available part numbers below.

Type S: Stud Dimensions

Mounting Code	P ± 1.0 (0.040)	T Thread Size
S	16.0 (0.630)	M12

Mounting Nut Dimensions

Part Number	ØK ± 2.0 (0.080)	M ± 1.0 (0.040)	N ± 1.0 (0.040)	ØQ ± 1.0 (0.040)	R ± 1.0 (0.040)
50-8D	30.0 (1.181)	19.0 (0.748)	18.0 (0.709)	22.0 (0.866)	1.40 (0.055)
50-8E	38.0 (1.496)	19.0 (0.748)	18.0 (0.709)	30.0 (1.181)	1.40 (0.055)

Return Group Chart



LARGE CAPACITANCE ALUMINUM ELECTROLYTIC CAPACITORS (UNITED CHEMI-CON, INC. Products)

Inverter-use screw terminal, 85°C

U37L Series

Part Numbering System for U37L Series When ordering, always specify complete 18-field global part number.

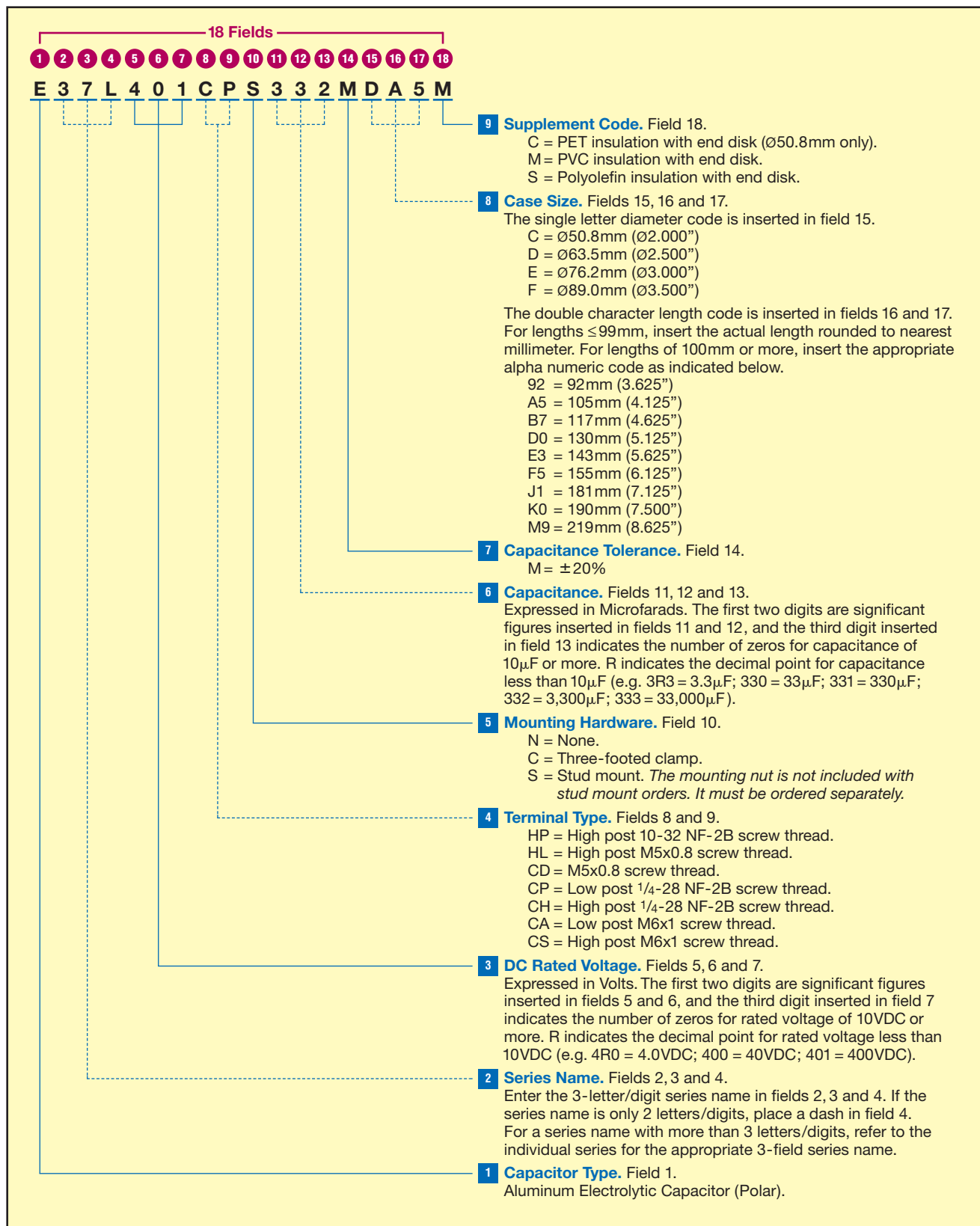

Return Group Chart



LARGE CAPACITANCE ALUMINUM ELECTROLYTIC CAPACITORS (UNITED CHEMI-CON, INC. Products)

Inverter-use screw terminal, 85°C

U37L Series

Standard Voltage Ratings - Screw Terminals

Rated Voltage (WVDC)	Capacitance (μF)	Global Part Number†	Nominal Case Size* D × L (mm)	Case Size Code	Maximum ESR (mΩ) at +25°C, 120Hz	Rated Ripple Current (A rms) at +85°C		
						120Hz	300Hz	>3kHz
350 Volts 400 Volts Surge	3,300	E37L351HPN332MCB7M	50 × 117	CB7	29	10.6	12.7	14.8
	3,300	E37L351HPN332MCD0M	50 × 130	CD0	29	11.0	13.1	15.3
	3,300	E37L351CPN332MD92M	63.5 × 92	D92	30	10.7	12.8	15.0
	3,900	E37L351CPN392MDA5M	63.5 × 105	DA5	26	12.2	14.6	17.0
	3,900	E37L351CPN392MDB7M	63.5 × 117	DB7	26	12.6	15.2	17.7
	4,700	E37L351CPN472MDD0M	63.5 × 130	DD0	21	14.4	17.3	20.2
	5,600	E37L351CPN562MDE3M	63.5 × 143	DE3	18	16.3	19.5	22.8
	4,700	E37L351CPN472ME92M	76.2 × 92	E92	22	13.9	16.7	19.5
	5,600	E37L351CPN562MEA5M	76.2 × 105	EA5	18	15.8	19.0	22.1
	6,800	E37L351CPN682MEB7M	76.2 × 117	EB7	15	18.1	21.7	25.4
	8,200	E37L351CPN822MEE3M	76.2 × 143	EE3	13	21.3	25.6	29.9
	12,000	E37L351CPN123MEJ1M	76.2 × 181	EJ1	9	28.2	33.9	39.5
	15,000	E37L351CPN153MEM9M	76.2 × 219	EM9	7	34.0	40.8	47.6
	6,800	E37L351CPN682MF92M	89 × 92	F92	15	18.3	22.0	25.6
	8,200	E37L351CPN822MFA5M	89 × 105	FA5	13	21.0	25.2	29.3
	8,200	E37L351CPN822MFB7M	89 × 117	FB7	13	21.8	26.1	30.5
	12,000	E37L351CPN123MFE3M	89 × 143	FE3	9	28.2	33.8	39.5
	12,000	E37L351CPN123MFF5M	89 × 155	FF5	9	29.0	34.8	40.6
15,000	E37L351CPN153MFK0M	89 × 190	FK0	7	35.0	42.0	49.1	
18,000	E37L351CPN183MFM9M	89 × 219	FM9	6	41.1	49.4	57.6	
400 Volts 450 Volts Surge	2,700	E37L401HPN272MCB7M	50 × 117	CB7	35	9.5	11.5	13.4
	3,300	E37L401HPN332MCD0M	50 × 130	CD0	29	11.0	13.1	15.3
	2,700	E37L401CPN272MD92M	63.5 × 92	D92	37	9.7	11.6	13.6
	3,300	E37L401CPN332MDA5M	63.5 × 105	DA5	30	11.2	13.4	15.7
	3,900	E37L401CPN392MDB7M	63.5 × 117	DB7	26	12.6	15.2	17.7
	3,900	E37L401CPN392MDD0M	63.5 × 130	DD0	26	13.1	15.7	18.4
	4,700	E37L401CPN472MDE3M	63.5 × 143	DE3	21	14.9	17.9	20.9
	3,900	E37L401CPN392ME92M	76.2 × 92	E92	27	12.7	15.2	17.7
	4,700	E37L401CPN472MEA5M	76.2 × 105	EA5	22	14.5	17.4	20.3
	5,600	E37L401CPN562MEB7M	76.2 × 117	EB7	18	16.4	19.7	23.0
	6,800	E37L401CPN682MEE3M	76.2 × 143	EE3	15	19.4	23.3	27.2
	10,000	E37L401CPN103MEJ1M	76.2 × 181	EJ1	10	25.8	30.9	36.1
	12,000	E37L401CPN123MEM9M	76.2 × 219	EM9	9	30.4	36.5	42.6
	5,600	E37L401CPN562MF92M	89 × 92	F92	18	16.6	20.0	23.3
	6,800	E37L401CPN682MFA5M	89 × 105	FA5	15	19.1	22.9	26.7
	8,200	E37L401CPN822MFB7M	89 × 117	FB7	13	21.8	26.1	30.5
	10,000	E37L401CPN103MFE3M	89 × 143	FE3	10	25.7	30.9	36.0
	12,000	E37L401CPN123MFF5M	89 × 155	FF5	9	29.0	34.8	40.6
15,000	E37L401CPN153MFK0M	89 × 190	FK0	7	35.0	42.0	49.1	
18,000	E37L401CPN183MFM9M	89 × 219	FM9	6	40.6	48.7	56.8	
420 Volts 470 Volts Surge	2,700	E37L421HPN272MCB7M	50 × 117	CB7	35	9.5	11.5	13.4
	2,900	E37L421HPN292MCD0M	50 × 130	CD0	33	10.3	12.3	14.4
	2,200	E37L421CPN222MD92M	63.5 × 92	D92	45	8.7	10.5	12.2
	2,700	E37L421CPN272MDA5M	63.5 × 105	DA5	37	10.1	12.1	14.2
	3,300	E37L421CPN332MDB7M	63.5 × 117	DB7	30	11.6	14.0	16.3
	3,900	E37L421CPN392MDD0M	63.5 × 130	DD0	26	13.1	15.7	18.4
	4,700	E37L421CPN472MDE3M	63.5 × 143	DE3	21	14.9	17.9	20.9
	3,900	E37L421CPN392ME92M	76.2 × 92	E92	27	12.7	15.2	17.7
	4,700	E37L421CPN472MEA5M	76.2 × 105	EA5	22	14.5	17.4	20.3
	5,600	E37L421CPN562MEB7M	76.2 × 117	EB7	18	16.4	19.7	23.0
	6,800	E37L421CPN682MEE3M	76.2 × 143	EE3	15	19.4	23.3	27.2
	8,200	E37L421CPN822MEJ1M	76.2 × 181	EJ1	13	23.3	28.0	32.7
	12,000	E37L421CPN123MEM9M	76.2 × 219	EM9	9	30.4	36.5	42.6
	5,600	E37L421CPN562MF92M	89 × 92	F92	18	16.6	20.0	23.3
	6,800	E37L421CPN682MFA5M	89 × 105	FA5	15	19.1	22.9	26.7

† For terminal, mounting and construction options, refer to the part numbering system for descriptions and codes.

* Refer to diagram of dimensions for detailed case size specifications.

Return Group Chart



LARGE CAPACITANCE ALUMINUM ELECTROLYTIC CAPACITORS (UNITED CHEMI-CON, INC. Products)

Inverter-use screw terminal, 85°C

U37L Series

Standard Voltage Ratings - Screw Terminals

Rated Voltage (WVDC)	Capacitance (μF)	Global Part Number†	Nominal Case Size* D × L (mm)	Case Size Code	Maximum ESR (mΩ) at +25°C, 120Hz	Rated Ripple Current (A rms) at +85°C		
						120Hz	300Hz	>3kHz
420 Volts 470 Volts Surge	6,800	E37L421CPN682MFB7M	89 × 117	FB7	15	19.8	23.8	27.8
	10,000	E37L421CPN103MFE3M	89 × 143	FE3	10	25.7	30.9	36.0
	10,000	E37L421CPN103MFF5M	89 × 155	FF5	10	26.5	31.8	37.1
	12,000	E37L421CPN123MFK0M	89 × 190	FK0	9	31.3	37.6	43.9
	15,000	E37L421CPN153MFM9M	89 × 219	FM9	7	37.0	44.5	51.9
450 Volts 500 Volts Surge	2,200	E37L451HPN222MCB7M	50 × 117	CB7	43	8.6	10.3	12.1
	2,200	E37L451HPN222MCD0M	50 × 130	CD0	43	8.9	10.7	12.5
	2,200	E37L451CPN222MD92M	63.5 × 92	D92	45	8.7	10.5	12.2
	2,200	E37L451CPN222MDA5M	63.5 × 105	DA5	45	9.1	11.0	12.8
	2,700	E37L451CPN272MDB7M	63.5 × 117	DB7	37	10.5	12.6	14.7
	3,300	E37L451CPN332MDD0M	63.5 × 130	DD0	30	12.1	14.5	16.9
	3,900	E37L451CPN392MDE3M	63.5 × 143	DE3	26	13.6	16.3	19.0
	3,300	E37L451CPN332ME92M	76.2 × 92	E92	31	11.6	14.0	16.3
	3,900	E37L451CPN392MEA5M	76.2 × 105	EA5	27	13.2	15.8	18.5
	4,700	E37L451CPN472MEB7M	76.2 × 117	EB7	22	15.1	18.1	21.1
	5,600	E37L451CPN562MEE3M	76.2 × 143	EE3	18	17.6	21.2	24.7
	6,800	E37L451CPN682MEJ1M	76.2 × 181	EJ1	15	21.2	25.5	29.7
	10,000	E37L451CPN103MEM9M	76.2 × 219	EM9	10	27.8	33.3	38.9
	4,700	E37L451CPN472MF92M	89 × 92	F92	22	15.2	18.3	21.3
	5,600	E37L451CPN562MFA5M	89 × 105	FA5	18	17.3	20.8	24.2
	5,600	E37L451CPN562MFB7M	89 × 117	FB7	18	18.0	21.6	25.2
	8,200	E37L451CPN822MFE3M	89 × 143	FE3	13	23.3	28.0	32.6
	8,200	E37L451CPN822MFF5M	89 × 155	FF5	13	24.0	28.8	33.6
12,000	E37L451CPN123MFK0M	89 × 190	FK0	9	31.3	37.6	43.9	
12,000	E37L451CPN123MFM9M	89 × 219	FM9	9	33.1	39.8	46.4	
500 Volts 550 Volts Surge	1,500	E37L501HPN152MCB7M	50 × 117	CB7	64	7.1	8.5	10.0
	1,500	E37L501HPN152MCD0M	50 × 130	CD0	64	7.4	8.9	10.3
	1,800	E37L501CPN182MD92M	63.5 × 92	D92	55	7.9	9.5	11.1
	2,200	E37L501CPN222MDA5M	63.5 × 105	DA5	45	9.1	11.0	12.8
	2,200	E37L501CPN222MDB7M	63.5 × 117	DB7	45	9.5	11.4	13.3
	2,700	E37L501CPN272MDD0M	63.5 × 130	DD0	37	10.9	13.1	15.3
	2,700	E37L501CPN272MDE3M	63.5 × 143	DE3	37	11.3	13.6	15.8
	2,700	E37L501CPN272ME92M	76.2 × 92	E92	38	10.5	12.6	14.7
	3,300	E37L501CPN332MEA5M	76.2 × 105	EA5	31	12.1	14.6	17.0
	3,300	E37L501CPN332MEB7M	76.2 × 117	EB7	31	12.6	15.2	17.7
	4,700	E37L501CPN472MEE3M	76.2 × 143	EE3	22	16.2	19.4	22.6
	5,600	E37L501CPN562MEJ1M	76.2 × 181	EJ1	18	19.3	23.1	27.0
	8,200	E37L501CPN822MEM9M	76.2 × 219	EM9	13	25.2	30.2	35.2
	3,900	E37L501CPN392MF92M	89 × 92	F92	27	13.9	16.6	19.4
	3,900	E37L501CPN392MFA5M	89 × 105	FA5	27	14.5	17.3	20.2
	4,700	E37L501CPN472MFB7M	89 × 117	FB7	22	16.5	19.8	23.1
	6,800	E37L501CPN682MFE3M	89 × 143	FE3	15	21.2	25.5	29.7
	6,800	E37L501CPN682MFF5M	89 × 155	FF5	15	21.9	26.2	30.6
	8,200	E37L501CPN822MFK0M	89 × 190	FK0	12	26.7	32.0	37.4
	10,000	E37L501CPN103MFM9M	89 × 219	FM9	9	33.1	39.8	46.4

† For terminal, mounting and construction options, refer to the part numbering system for descriptions and codes.

* Refer to diagram of dimensions for detailed case size specifications.



U37X Series



- Large Can
- Screw Terminals
- General Purpose U37 Grade
- High Ripple
- 350 to 500VDC Ratings
- RoHS Compliant
- 15,000 Hours Lifetime at +85°C
- Up to 175,000 Hours Useful Life



The U37X series is the longest life version of the U37 grade series and is specifically designed to provide the ripple current capability and long life required for high reliability inverter applications. The U37X has an endurance rating of 15,000 hours at +85°C with the rated ripple current applied. The useful life can exceed 175,000 hours at +40°C and 2.1x the ripple current. These capacitors are available in a variety of high current English or Metric thread terminals. Mounting options include a three-footed clamp or bottom threaded stud. Custom designs are also available.

Summary of Specifications

- Screw terminals: high and low post, English and Metric thread.
- Capacitance range: 1,200 to 18,000µF.
- Voltage range: 350 to 500VDC.
- Category temperature range: -40°C to +85°C.
- Leakage current: 0.02CV(µA) or 5mA, whichever is smaller, after 5 minutes at +25°C.
- Standard capacitance tolerance: ±20%
- Nominal case size (D×L): D = 50mm (2.000") to 89mm (3.500"); L = 92mm (3.625") to 219mm (8.625").
- Rated lifetime: 15,000 hours at +85°C with rated ripple current applied.

Return Group Chart



LARGE CAPACITANCE ALUMINUM ELECTROLYTIC CAPACITORS (UNITED CHEMI-CON, INC. Products)

Inverter-use screw terminal, 85°C

U37X Series

U37X Specifications - Screw Terminals

Item	Characteristics																																															
Category Temperature Range	-40 to +85°C																																															
Rated Voltage Range	350 to 500VDC																																															
Capacitance Range	1,200 to 18,000µF at +25°C, 120Hz																																															
Capacitance Tolerance	±20% (M) at +25°C, 120Hz																																															
Leakage Current	I = 0.02CV (µA) or 5mA, whichever is smaller, after 5 minutes at +25°C. Where I = Max. leakage current (µA), C = Nominal capacitance (µF) and V = Rated voltage (V)																																															
Rated Ripple Current Multipliers	<p>Ambient Temperature (°C)</p> <table border="1" style="margin-left: 20px;"> <tr> <td style="text-align: center;">+45°C</td> <td style="text-align: center;">+65°C</td> <td style="text-align: center;">+85°C</td> </tr> <tr> <td style="text-align: center;">2.82</td> <td style="text-align: center;">1.73</td> <td style="text-align: center;">1.00</td> </tr> </table> <p>Frequency (Hz)</p> <table border="1" style="margin-left: 20px;"> <tr> <td style="text-align: center;">DC Rated Voltage</td> <td style="text-align: center;">50Hz</td> <td style="text-align: center;">120Hz</td> <td style="text-align: center;">300Hz</td> <td style="text-align: center;">1kHz</td> <td style="text-align: center;">3kHz</td> <td style="text-align: center;">10kHz</td> </tr> <tr> <td style="text-align: center;">350-500V</td> <td style="text-align: center;">0.80</td> <td style="text-align: center;">1.00</td> <td style="text-align: center;">1.20</td> <td style="text-align: center;">1.30</td> <td style="text-align: center;">1.40</td> <td style="text-align: center;">1.41</td> </tr> </table> <p>To determine maximum ripple current at a specified temperature and frequency, use the appropriate multiplier shown.</p>	+45°C	+65°C	+85°C	2.82	1.73	1.00	DC Rated Voltage	50Hz	120Hz	300Hz	1kHz	3kHz	10kHz	350-500V	0.80	1.00	1.20	1.30	1.40	1.41																											
+45°C	+65°C	+85°C																																														
2.82	1.73	1.00																																														
DC Rated Voltage	50Hz	120Hz	300Hz	1kHz	3kHz	10kHz																																										
350-500V	0.80	1.00	1.20	1.30	1.40	1.41																																										
Endurance (Load Life)	<p>The following specifications shall be satisfied when the capacitors are restored to +25°C after subjecting them to DC voltage for 15,000 hours at +85°C with the rated ripple current applied. The sum of the DC voltage and peak AC voltage must not exceed the full rated voltage of the capacitors.</p> <p>Capacitance change: ≤ 20% from initial measurement ESR change : ≤ 200% of initial specified limit Leakage current : ≤ initial specified limit</p>																																															
Useful Life	<p>With specified standard voltage and ripple current applied, typical life as function of ambient temperature is listed below.</p> <table border="1" style="margin-left: 20px;"> <tr> <td style="text-align: center;">+85°C</td> <td style="text-align: center;">20,000 hours max.</td> </tr> <tr> <td style="text-align: center;">+65°C</td> <td style="text-align: center;">71,600 hours max.</td> </tr> <tr> <td style="text-align: center;">+45°C</td> <td style="text-align: center;">175,000 hours max.</td> </tr> </table> <p>Capacitance change: ≤ 30% from initial measurement ESR change : ≤ 300% of initial specified limit Leakage current : ≤ initial specified limit</p>	+85°C	20,000 hours max.	+65°C	71,600 hours max.	+45°C	175,000 hours max.																																									
+85°C	20,000 hours max.																																															
+65°C	71,600 hours max.																																															
+45°C	175,000 hours max.																																															
Shelf Life	<p>The following specifications shall be satisfied when the capacitors are restored to +25°C after exposing them for 500 hours at +85°C without voltage applied. The rated voltage shall be applied to the capacitors for a minimum of 30 minutes, at least 24 hours and not more than 48 hours before the measurements.</p> <p>Capacitance change: ≤ 20% from initial measurement ESR change : ≤ 200% of initial specified limit Leakage current : ≤ initial specified limit</p>																																															
Vibration Rating	10-55Hz, 10g sinusoidal in three axes, 2 hours per axis.																																															
Maximum Tightening Torque	<table border="1" style="margin-left: 20px;"> <tr> <td style="text-align: center;">Terminal Code</td> <td style="text-align: center;">HP</td> <td style="text-align: center;">HL</td> <td style="text-align: center;">CD</td> <td style="text-align: center;">CP</td> <td style="text-align: center;">CH</td> <td style="text-align: center;">CA</td> <td style="text-align: center;">CS</td> </tr> <tr> <td style="text-align: center;">Thread Size</td> <td style="text-align: center;">10-32 NF-2B</td> <td colspan="2" style="text-align: center;">M5x0.8-6H</td> <td colspan="2" style="text-align: center;">1/4-28 NF-2B</td> <td colspan="2" style="text-align: center;">M6x1-6H</td> </tr> <tr> <td style="text-align: center;">3 Threads Engaged</td> <td colspan="3" style="text-align: center;">2.0 N·m (18.0 in·lb)</td> <td colspan="4" style="text-align: center;">4.0 N·m (35.0 in·lb)</td> </tr> <tr> <td style="text-align: center;">6 Threads Engaged</td> <td colspan="3" style="text-align: center;">2.8 N·m (25.0 in·lb)</td> <td colspan="4" style="text-align: center;">6.2 N·m (55.0 in·lb)</td> </tr> </table>	Terminal Code	HP	HL	CD	CP	CH	CA	CS	Thread Size	10-32 NF-2B	M5x0.8-6H		1/4-28 NF-2B		M6x1-6H		3 Threads Engaged	2.0 N·m (18.0 in·lb)			4.0 N·m (35.0 in·lb)				6 Threads Engaged	2.8 N·m (25.0 in·lb)			6.2 N·m (55.0 in·lb)																		
Terminal Code	HP	HL	CD	CP	CH	CA	CS																																									
Thread Size	10-32 NF-2B	M5x0.8-6H		1/4-28 NF-2B		M6x1-6H																																										
3 Threads Engaged	2.0 N·m (18.0 in·lb)			4.0 N·m (35.0 in·lb)																																												
6 Threads Engaged	2.8 N·m (25.0 in·lb)			6.2 N·m (55.0 in·lb)																																												
Typical Inductance (nH) at 1MHz	<table border="1" style="margin-left: 20px;"> <tr> <td rowspan="2" style="text-align: center;">Case Diameter (mm)</td> <td colspan="7" style="text-align: center;">Terminal Code</td> </tr> <tr> <td style="text-align: center;">HP</td> <td style="text-align: center;">HL</td> <td style="text-align: center;">CD</td> <td style="text-align: center;">CP</td> <td style="text-align: center;">CH</td> <td style="text-align: center;">CA</td> <td style="text-align: center;">CS</td> </tr> <tr> <td style="text-align: center;">ø50.8</td> <td style="text-align: center;">—</td> <td style="text-align: center;">—</td> <td style="text-align: center;">NA</td> <td style="text-align: center;">NA</td> <td style="text-align: center;">NA</td> <td style="text-align: center;">NA</td> <td style="text-align: center;">NA</td> </tr> <tr> <td style="text-align: center;">ø63.5</td> <td style="text-align: center;">—</td> <td style="text-align: center;">—</td> <td style="text-align: center;">—</td> <td style="text-align: center;">—</td> <td style="text-align: center;">—</td> <td style="text-align: center;">—</td> <td style="text-align: center;">—</td> </tr> <tr> <td style="text-align: center;">ø76.2</td> <td style="text-align: center;">30</td> <td style="text-align: center;">30</td> <td style="text-align: center;">25</td> <td style="text-align: center;">20</td> <td style="text-align: center;">25</td> <td style="text-align: center;">20</td> <td style="text-align: center;">25</td> </tr> <tr> <td style="text-align: center;">ø89.0</td> <td style="text-align: center;">30</td> <td style="text-align: center;">30</td> <td style="text-align: center;">25</td> <td style="text-align: center;">20</td> <td style="text-align: center;">25</td> <td style="text-align: center;">20</td> <td style="text-align: center;">25</td> </tr> </table>	Case Diameter (mm)	Terminal Code							HP	HL	CD	CP	CH	CA	CS	ø50.8	—	—	NA	NA	NA	NA	NA	ø63.5	—	—	—	—	—	—	—	ø76.2	30	30	25	20	25	20	25	ø89.0	30	30	25	20	25	20	25
Case Diameter (mm)	Terminal Code																																															
	HP	HL	CD	CP	CH	CA	CS																																									
ø50.8	—	—	NA	NA	NA	NA	NA																																									
ø63.5	—	—	—	—	—	—	—																																									
ø76.2	30	30	25	20	25	20	25																																									
ø89.0	30	30	25	20	25	20	25																																									
Custom Designs	Custom CV values per case size and termination type may be available upon request. Contact appropriate representative with specific requirements.																																															

Return Group Chart



LARGE CAPACITANCE ALUMINUM ELECTROLYTIC CAPACITORS (UNITED CHEMI-CON, INC. Products)

Inverter-use screw terminal, 85°C

U37X Series

U37X Useful Life

Useful Life: 20,000 Hours at +85°C

The life expectancy of a capacitor is shown as a function of ambient temperature and ripple current load.

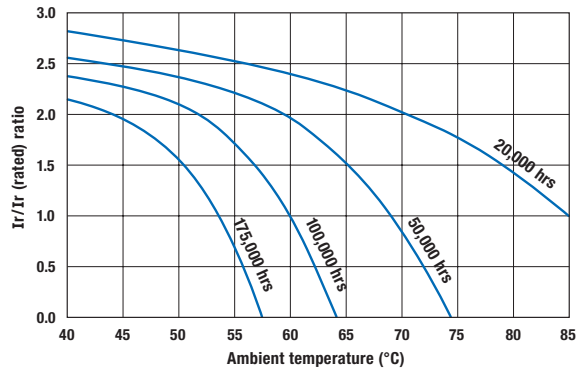
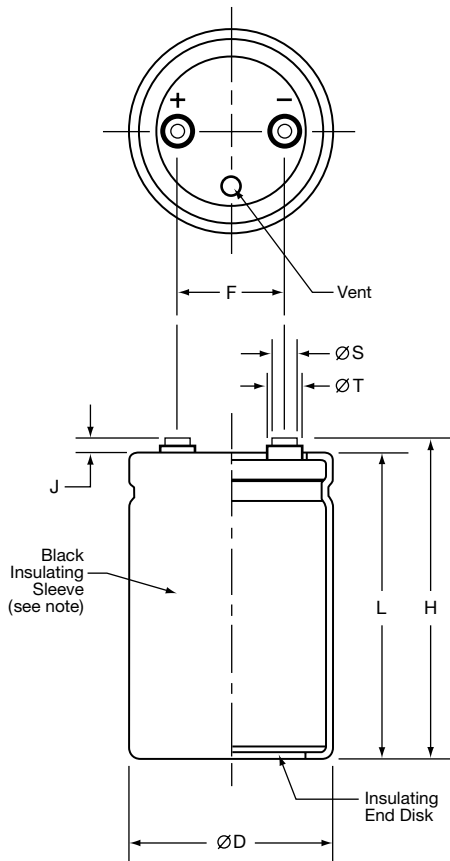

Diagram of Dimensions - Screw Terminals

Large Can/Screw Terminals

Unit: mm (inches)



Case Dimensions and Standard Box Quantities

Case Size Code	øD +2.0 (0.080)	L ±1.0 (0.040)	F ±0.25 (0.010)	Standard Box Quantity
CB7 CD0	50.8 (2.000)	117 (4.625) 130 (5.125)	22.2 (0.875)	49
D92 DA5 DB7 DD0 DE3	63.5 (2.500)	92 (3.625) 105 (4.125) 117 (4.625) 130 (5.125) 143 (5.625)	28.6 (1.125)	20
E92 EA5 EB7 EE3 EJ1 EM9	76.2 (3.000)	92 (3.625) 105 (4.125) 117 (4.625) 143 (5.625) 181 (7.125) 219 (8.625)	31.8 (1.250)	16 9
F92 FA5 FB7 FE3 FF5 FK0 FM9	89.0 (3.500)	92 (3.625) 105 (4.125) 117 (4.625) 143 (5.625) 155 (6.125) 190 (7.500) 219 (8.625)	31.8 (1.250)	5

Note:

In some cases, the color of the sleeve may change slightly due to the operating conditions, however, the discoloration will not impair capacitor function.

Terminal Specifications

Terminal Code	Available Case Diameter		Thread Size	Minimum Thread Depth	J ±0.5 (0.020)	H ±2.0 (0.080)	øS ±0.25 (0.010)	øT ±0.25 (0.010)
	øD Code	øD mm (inches)						
HP	C	50.8 (2.000)	10-32 NF-2B	9.5 (0.375)	6.4 (0.250)	L+J	8.0 (0.313)	11.1 (0.438)
HL	C	50.8 (2.000)	M5x0.8-6H	9.5 (0.375)	6.4 (0.250)	L+J	8.0 (0.313)	11.1 (0.438)
CD	D-E	63.5 - 76.2 (2.500 - 3.000)	M5x0.8-6H	8.5 (0.335)	5.0 (0.200)	L+J	13.0 (0.512)	18.8 (0.740)
CP	D-F	63.5 - 89.0 (2.500 - 3.500)	1/4-28 NF-2B	8.7 (0.344)	2.4 (0.093)	L+J	17.5 (0.689)	—
CH	D-F	63.5 - 89.0 (2.500 - 3.500)	1/4-28 NF-2B	11.9 (0.468)	6.4 (0.250)	L+J	17.5 (0.689)	—
CA	D-F	63.5 - 89.0 (2.500 - 3.500)	M6x1-6H	8.7 (0.344)	2.4 (0.093)	L+J	17.5 (0.689)	—
CS	D-F	63.5 - 89.0 (2.500 - 3.500)	M6x1-6H	11.9 (0.468)	6.4 (0.250)	L+J	17.5 (0.689)	—

Mounting Hardware is optional. Refer to hardware specifications on the following page.



U37X Series

Mounting Hardware - Screw Terminals

Type C: Three-Footed Clamp

Unit: mm (inches)

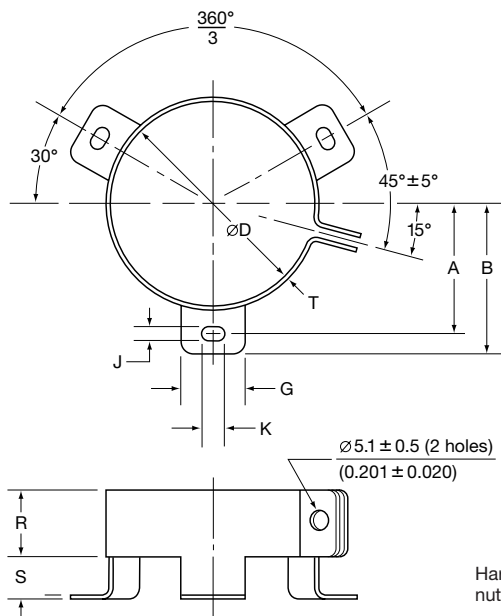

Hardware: Screw, washer and hexagon nut included with each clamp.

Type C: Clamp Dimensions

Mounting Code	Case $\varnothing D$	A $\pm 1.0 (0.040)$	B $\pm 1.0 (0.040)$	G $\pm 1.0 (0.040)$	J $\pm 0.5 (0.020)$	K $\pm 0.5 (0.020)$	R $\pm 1.0 (0.040)$	S $\pm 1.0 (0.040)$	T $\pm 0.5 (0.020)$
C	50.8 (2.000)	31.8 (1.250)	36.5 (1.437)	13.3 (0.524)	4.5 (0.177)	7.1 (0.280)	19.1 (0.751)	9.5 (0.374)	0.8 (0.032)
C	63.5 (2.500)	38.1 (1.500)	42.9 (1.689)	13.3 (0.524)	4.5 (0.177)	7.1 (0.280)	19.1 (0.751)	9.5 (0.374)	0.8 (0.032)
C	76.2 (3.000)	44.5 (1.750)	49.2 (1.937)	13.3 (0.524)	4.5 (0.177)	7.1 (0.280)	19.1 (0.751)	9.5 (0.374)	1.0 (0.040)
C	89.0 (3.500)	50.8 (2.000)	56.5 (2.224)	16.0 (0.630)	4.5 (0.177)	8.0 (0.313)	21.0 (0.827)	9.0 (0.354)	1.0 (0.040)

Type S: Stud Mounting

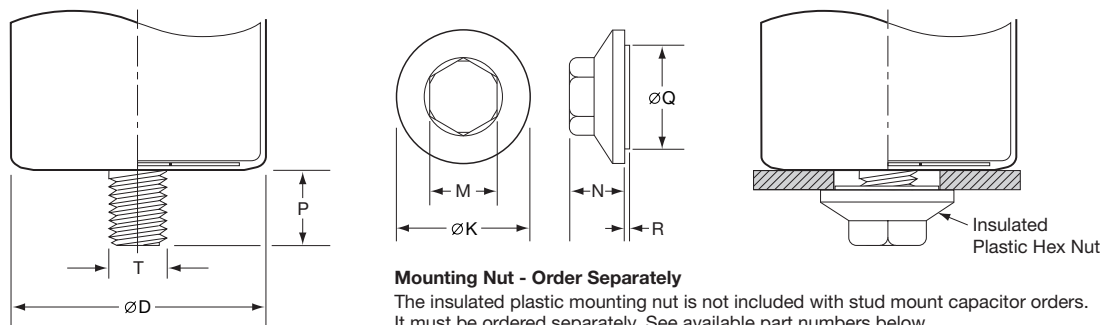

Mounting Nut - Order Separately

The insulated plastic mounting nut is not included with stud mount capacitor orders. It must be ordered separately. See available part numbers below.

Type S: Stud Dimensions

Mounting Code	P $\pm 1.0 (0.040)$	T Thread Size
S	16.0 (0.630)	M12

Mounting Nut Dimensions

Part Number	$\varnothing K$ $\pm 2.0 (0.080)$	M $\pm 1.0 (0.040)$	N $\pm 1.0 (0.040)$	$\varnothing Q$ $\pm 1.0 (0.040)$	R $\pm 1.0 (0.040)$
50-8D	30.0 (1.181)	19.0 (0.748)	18.0 (0.709)	22.0 (0.866)	1.40 (0.055)
50-8E	38.0 (1.496)	19.0 (0.748)	18.0 (0.709)	30.0 (1.181)	1.40 (0.055)

Return Group Chart



LARGE CAPACITANCE ALUMINUM ELECTROLYTIC CAPACITORS (UNITED CHEMI-CON, INC. Products)

Inverter-use screw terminal, 85°C

U37X Series

Part Numbering System for U37X Series When ordering, always specify complete 18-field global part number.

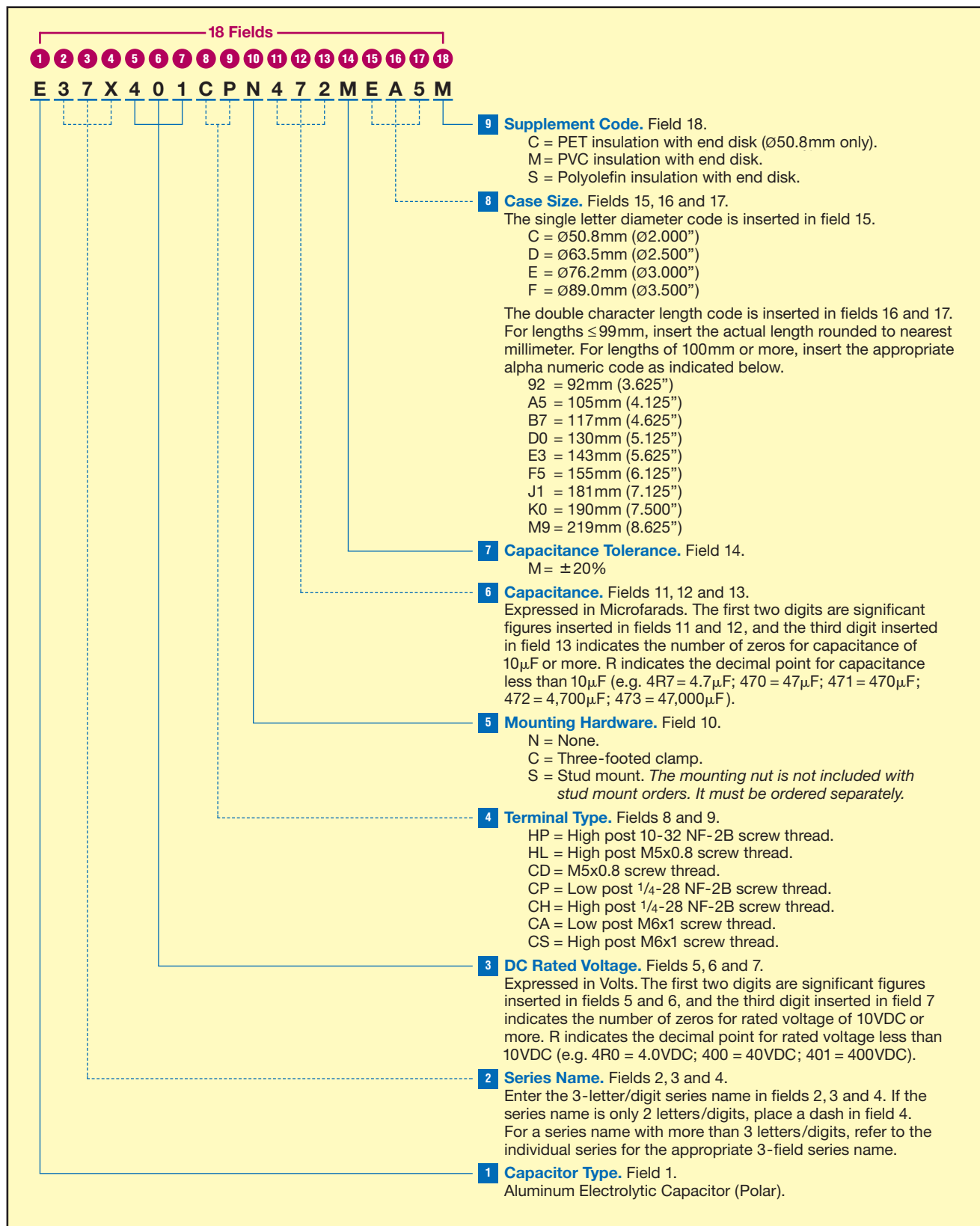

Return Group Chart



LARGE CAPACITANCE ALUMINUM ELECTROLYTIC CAPACITORS (UNITED CHEMI-CON, INC. Products)

Inverter-use screw terminal, 85°C

U37X Series

Standard Voltage Ratings - Screw Terminals

Rated Voltage (WVDC)	Capacitance (μF)	Global Part Number†	Nominal Case Size* D × L (mm)	Case Size Code	Maximum ESR (mΩ) at +25°C, 120Hz	Rated Ripple Current (A rms) at +85°C		
						120Hz	300Hz	>3kHz
350 Volts 400 Volts Surge	2,700	E37X351HPN272MCB7M	50 × 117	CB7	35	9.6	11.5	13.4
	3,300	E37X351HPN332MCD0M	50 × 130	CD0	31	10.6	12.8	14.9
	2,700	E37X351CPN272MD92M	63.5 × 92	D92	37	9.7	11.6	13.5
	3,300	E37X351CPN332MDA5M	63.5 × 105	DA5	31	11.1	13.3	15.5
	3,900	E37X351CPN392MDB7M	63.5 × 117	DB7	26	12.4	14.9	17.4
	4,700	E37X351CPN472MDD0M	63.5 × 130	DD0	23	13.8	16.5	19.3
	4,700	E37X351CPN472MDE3M	63.5 × 143	DE3	21	15.1	18.1	21.2
	3,900	E37X351CPN392ME92M	76.2 × 92	E92	26	12.7	15.2	17.8
	4,700	E37X351CPN472MEA5M	76.2 × 105	EA5	22	14.5	17.4	20.3
	5,600	E37X351CPN562MEB7M	76.2 × 117	EB7	19	16.3	19.5	22.8
	8,200	E37X351CPN822MEE3M	76.2 × 143	EE3	15	19.8	23.7	27.7
	10,000	E37X351CPN103MEJ1M	76.2 × 181	EJ1	11	25.0	30.0	35.0
	12,000	E37X351CPN123MEM9M	76.2 × 219	EM9	9	30.1	36.1	42.2
	5,600	E37X351CPN562MF92M	89 × 92	F92	19	16.2	19.4	22.7
	6,800	E37X351CPN682MFA5M	89 × 105	FA5	16	18.5	22.2	25.9
	8,200	E37X351CPN822MFB7M	89 × 117	FB7	14	20.7	24.9	29.0
	12,000	E37X351CPN123MFE3M	89 × 143	FE3	11	25.2	30.2	35.2
	12,000	E37X351CPN123MFF5M	89 × 155	FF5	10	27.3	32.8	38.2
15,000	E37X351CPN153MFK0M	89 × 190	FK0	8	33.3	40.0	46.6	
18,000	E37X351CPN183MFM9M	89 × 219	FM9	6	38.2	45.8	53.5	
400 Volts 450 Volts Surge	2,700	E37X401HPN272MCB7M	50 × 117	CB7	41	8.9	10.7	12.5
	2,700	E37X401HPN272MCD0M	50 × 130	CD0	35	9.9	11.9	13.9
	2,700	E37X401CPN272MD92M	63.5 × 92	D92	43	9.0	10.8	12.6
	2,700	E37X401CPN272MDA5M	63.5 × 105	DA5	36	10.3	12.3	14.4
	3,300	E37X401CPN332MDB7M	63.5 × 117	DB7	31	11.6	13.9	16.2
	3,900	E37X401CPN392MDD0M	63.5 × 130	DD0	27	12.8	15.4	18.0
	3,900	E37X401CPN392MDE3M	63.5 × 143	DE3	24	14.1	16.9	19.7
	3,900	E37X401CPN392ME92M	76.2 × 92	E92	30	11.8	14.2	16.5
	4,700	E37X401CPN472MEA5M	76.2 × 105	EA5	25	13.5	16.2	18.9
	5,600	E37X401CPN562MEB7M	76.2 × 117	EB7	22	15.2	18.2	21.2
	6,800	E37X401CPN682MEE3M	76.2 × 143	EE3	17	18.4	22.1	25.8
	8,200	E37X401CPN822MEJ1M	76.2 × 181	EJ1	13	23.3	27.9	32.6
	12,000	E37X401CPN123MEM9M	76.2 × 219	EM9	10	28.0	33.6	39.3
	5,600	E37X401CPN562MF92M	89 × 92	F92	22	15.1	18.1	21.1
	6,800	E37X401CPN682MFA5M	89 × 105	FA5	19	17.2	20.6	24.1
	6,800	E37X401CPN682MFB7M	89 × 117	FB7	16	19.3	23.2	27.0
	10,000	E37X401CPN103MFE3M	89 × 143	FE3	12	23.4	28.1	32.8
	10,000	E37X401CPN103MFF5M	89 × 155	FF5	11	25.4	30.5	35.6
12,000	E37X401CPN123MFK0M	89 × 190	FK0	9	31.0	37.2	43.4	
15,000	E37X401CPN153MFM9M	89 × 219	FM9	7	35.6	42.7	49.8	
420 Volts 470 Volts Surge	2,200	E37X421HPN222MCB7M	50 × 117	CB7	44	8.5	10.2	11.9
	2,700	E37X421HPN272MCD0M	50 × 130	CD0	39	9.4	11.3	13.2
	2,200	E37X421CPN222MD92M	63.5 × 92	D92	47	8.6	10.3	12.0
	2,700	E37X421CPN272MDA5M	63.5 × 105	DA5	39	9.8	11.8	13.8
	3,300	E37X421CPN332MDB7M	63.5 × 117	DB7	33	11.0	13.3	15.5
	3,900	E37X421CPN392MDD0M	63.5 × 130	DD0	29	12.2	14.7	17.1
	3,900	E37X421CPN392MDE3M	63.5 × 143	DE3	26	13.4	16.1	18.8
	3,300	E37X421CPN332ME92M	76.2 × 92	E92	33	11.3	13.5	15.8
	3,900	E37X421CPN392MEA5M	76.2 × 105	EA5	28	12.9	15.5	18.0
	4,700	E37X421CPN472MEB7M	76.2 × 117	EB7	24	14.5	17.4	20.3
	5,600	E37X421CPN562MEE3M	76.2 × 143	EE3	19	17.6	21.1	24.6
	8,200	E37X421CPN822MEJ1M	76.2 × 181	EJ1	14	22.2	26.6	31.1
	10,000	E37X421CPN103MEM9M	76.2 × 219	EM9	11	26.8	32.1	37.5
	4,700	E37X421CPN472MF92M	89 × 92	F92	25	14.4	17.3	20.2
	5,600	E37X421CPN562MFA5M	89 × 105	FA5	21	16.4	19.7	23.0

† For terminal, mounting and construction options, refer to the part numbering system for descriptions and codes.

* Refer to diagram of dimensions for detailed case size specifications.

Return Group Chart



LARGE CAPACITANCE ALUMINUM ELECTROLYTIC CAPACITORS (UNITED CHEMI-CON, INC. Products)

Inverter-use screw terminal, 85°C

U37X Series

Standard Voltage Ratings - Screw Terminals

Rated Voltage (WVDC)	Capacitance (μF)	Global Part Number†	Nominal Case Size* D × L (mm)	Case Size Code	Maximum ESR (mΩ) at +25°C, 120Hz	Rated Ripple Current (A rms) at +85°C		
						120Hz	300Hz	>3kHz
420 Volts 470 Volts Surge	6,800	E37X421CPN682MFB7M	89 × 117	FB7	18	18.4	22.1	25.8
	8,200	E37X421CPN822MFE3M	89 × 143	FE3	14	22.4	26.8	31.3
	10,000	E37X421CPN103MFF5M	89 × 155	FF5	12	24.3	29.1	34.0
	12,000	E37X421CPN123MFK0M	89 × 190	FK0	10	29.6	35.5	41.4
	15,000	E37X421CPN153MFM9M	89 × 219	FM9	8	34.0	40.7	47.5
450 Volts 500 Volts Surge	1,800	E37X451HPN182MCB7M	50 × 117	CB7	51	8.0	9.6	11.2
	2,200	E37X451HPN222MCD0M	50 × 130	CD0	44	8.9	10.6	12.4
	2,200	E37X451CPN222MD92M	63.5 × 92	D92	53	8.1	9.7	11.3
	2,200	E37X451CPN222MDA5M	63.5 × 105	DA5	44	9.2	11.1	12.9
	2,700	E37X451CPN272MDB7M	63.5 × 117	DB7	38	10.4	12.4	14.5
	3,300	E37X451CPN332MDD0M	63.5 × 130	DD0	33	11.5	13.8	16.1
	3,900	E37X451CPN392MDE3M	63.5 × 143	DE3	30	12.6	15.1	17.6
	3,300	E37X451CPN332ME92M	76.2 × 92	E92	38	10.6	12.7	14.8
	3,900	E37X451CPN392MEA5M	76.2 × 105	EA5	32	12.1	14.5	16.9
	3,900	E37X451CPN392MEB7M	76.2 × 117	EB7	27	13.6	16.3	19.0
	5,600	E37X451CPN562MEE3M	76.2 × 143	EE3	21	16.5	19.8	23.1
	6,800	E37X451CPN682MEJ1M	76.2 × 181	EJ1	16	20.8	25.0	29.2
	8,200	E37X451CPN822MEM9M	76.2 × 219	EM9	13	25.1	30.1	35.2
	3,900	E37X451CPN392MF92M	89 × 92	F92	28	13.5	16.2	18.9
	4,700	E37X451CPN472MFA5M	89 × 105	FA5	23	15.4	18.5	21.6
	5,600	E37X451CPN562MFB7M	89 × 117	FB7	20	17.3	20.7	24.2
	8,200	E37X451CPN822MFE3M	89 × 143	FE3	16	21.0	25.2	29.4
	8,200	E37X451CPN822MFF5M	89 × 155	FF5	14	22.8	27.3	31.9
10,000	E37X451CPN103MFK0M	89 × 190	FK0	11	27.8	33.3	38.9	
12,000	E37X451CPN123MFM9M	89 × 219	FM9	9	32.2	38.6	45.0	
500 Volts 550 Volts Surge	1,200	E37X501HPN122MCB7M	50 × 117	CB7	78	6.4	7.7	9.0
	1,500	E37X501HPN152MCD0M	50 × 130	CD0	68	7.2	8.6	10.0
	1,500	E37X501CPN152MD92M	63.5 × 92	D92	67	7.2	8.6	10.1
	1,800	E37X501CPN182MDA5M	63.5 × 105	DA5	56	8.2	9.9	11.5
	2,200	E37X501CPN222MDB7M	63.5 × 117	DB7	48	9.3	11.1	13.0
	2,700	E37X501CPN272MDD0M	63.5 × 130	DD0	42	10.3	12.3	14.4
	2,700	E37X501CPN272MDE3M	63.5 × 143	DE3	37	11.3	13.5	15.8
	2,200	E37X501CPN222ME92M	76.2 × 92	E92	48	9.5	11.3	13.2
	2,700	E37X501CPN272MEA5M	76.2 × 105	EA5	40	10.8	13.0	15.1
	3,300	E37X501CPN332MEB7M	76.2 × 117	EB7	34	12.1	14.6	17.0
	3,900	E37X501CPN392MEE3M	76.2 × 143	EE3	26	14.8	17.7	20.7
	5,600	E37X501CPN562MEJ1M	76.2 × 181	EJ1	20	18.6	22.3	26.1
	6,800	E37X501CPN682MEM9M	76.2 × 219	EM9	16	22.5	26.9	31.4
	3,300	E37X501CPN332MF92M	89 × 92	F92	35	12.1	14.5	16.9
	3,900	E37X501CPN392MFA5M	89 × 105	FA5	29	13.8	16.5	19.3
	4,700	E37X501CPN472MFB7M	89 × 117	FB7	25	15.5	18.5	21.6
	5,600	E37X501CPN562MFE3M	89 × 143	FE3	19	18.8	22.5	26.3
	6,800	E37X501CPN682MFF5M	89 × 155	FF5	18	20.4	24.4	28.5
	8,200	E37X501CPN822MFK0M	89 × 190	FK0	14	24.8	29.8	34.8
	10,000	E37X501CPN103MFM9M	89 × 219	FM9	12	28.5	34.2	39.9

†For terminal, mounting and construction options, refer to the part numbering system for descriptions and codes.

*Refer to diagram of dimensions for detailed case size specifications.



UTOR Series



- Large Can Toroidal Design
- Lowest Thermal Resistance
- Optimum Cooling Capability
- New Lower Profile Sizes
- New Heat-Sink Mounting Kit
- RoHS Compliant (Pb-Free)



The UTOR series now offers higher capacitance and ripple current per case size. The upgrade allows the inverter designer to significantly reduce the size, weight, and cost of the capacitor bank. Toroidal geometry is ideal for cooling by either forced air or by heat-sink with the use of a new mounting kit option. The heat-sink kit option provides optimum thermal transfer while maintaining electrical isolation. These capacitors have an endurance rating of 5,000 hours at 105°C or 20,000 hours at 85°C with the rated ripple current applied. The UTOR series represents the optimum cost per amp of ripple current for a screw terminal mounted electrolytic capacitor.

Summary of Specifications

- Screw terminals, high ripple Metric thread.
- Capacitance range: 680 to 10,000µF.
- Voltage range: 350 to 500VDC.
- Operating temperature range: -40°C to +105°C.
- Leakage current: 0.02CV(µA) or 5mA, whichever is smaller, after 5 minutes at +25°C.
- Standard capacitance tolerance: ±20%
- Nominal case size (D×L): D = 76mm (3.000"); L = 54mm (2.125") to 168mm (6.625").
- Rated lifetime: 5,000 hours at +105°C with rated ripple current applied.

Return Group Chart



LARGE CAPACITANCE ALUMINUM ELECTROLYTIC CAPACITORS (UNITED CHEMI-CON, INC. Products) Inverter-use screw terminal, 105°C

UTOR Series

UTOR Specifications - Screw Terminals

Item	Characteristics																											
Category Temperature Range	-40 to +105°C																											
Rated Voltage Range	350 to 500VDC																											
Capacitance Range	680 to 10,000 μ F at +25°C, 120Hz																											
Capacitance Tolerance	\pm 20% (M) at +25°C, 120Hz																											
Leakage Current	$I = 0.02CV$ (μ A) or 5mA, whichever is smaller, after 5 minutes at +25°C. Where I = Max. leakage current (μ A), C = Nominal capacitance (μ F) and V = Rated voltage (V)																											
Rated Ripple Current Multipliers	<p>Ambient Temperature (°C)</p> <table border="1"> <thead> <tr> <th>+45°C</th> <th>+65°C</th> <th>+85°C</th> <th>+105°C</th> </tr> </thead> <tbody> <tr> <td>2.45</td> <td>2.12</td> <td>1.73</td> <td>1.00</td> </tr> </tbody> </table> <p>Cooling</p> <table border="1"> <thead> <tr> <th rowspan="2">Mounting Type</th> <th colspan="3">Air Velocity</th> </tr> <tr> <th>Static</th> <th>1.0m/s</th> <th>2.0m/s</th> </tr> </thead> <tbody> <tr> <td>Clamp Mount</td> <td>1.00</td> <td>1.20</td> <td>1.30</td> </tr> <tr> <td>Heat-Sink (air cooled)</td> <td>1.20</td> <td>1.45</td> <td>1.55</td> </tr> <tr> <td>Heat-Sink (fluid cooled)</td> <td>1.35</td> <td>1.65</td> <td>1.75</td> </tr> </tbody> </table>	+45°C	+65°C	+85°C	+105°C	2.45	2.12	1.73	1.00	Mounting Type	Air Velocity			Static	1.0m/s	2.0m/s	Clamp Mount	1.00	1.20	1.30	Heat-Sink (air cooled)	1.20	1.45	1.55	Heat-Sink (fluid cooled)	1.35	1.65	1.75
+45°C	+65°C	+85°C	+105°C																									
2.45	2.12	1.73	1.00																									
Mounting Type	Air Velocity																											
	Static	1.0m/s	2.0m/s																									
Clamp Mount	1.00	1.20	1.30																									
Heat-Sink (air cooled)	1.20	1.45	1.55																									
Heat-Sink (fluid cooled)	1.35	1.65	1.75																									
Endurance (Load Life)	<p>The following specifications shall be satisfied when the capacitors are restored to +25°C after subjecting them to DC voltage for 5,000 hours at +105°C with the rated ripple current applied. The sum of the DC voltage and peak AC voltage must not exceed the full rated voltage of the capacitors.</p> <p>Capacitance change: $\leq \pm 20\%$ of initial measured value ESR change : $\leq 200\%$ of initial specified value Leakage current : \leq initial specified value</p>																											
Shelf Test	<p>The following specifications shall be satisfied when the capacitors are restored to +25°C after exposing them for 1,000 hours at +105°C without voltage applied. The rated voltage shall be applied to the capacitors for a minimum of 30 minutes, at least 24 hours and not more than 48 hours before the measurements.</p> <p>Capacitance change: $\leq \pm 20\%$ of initial measured value ESR change : $\leq 200\%$ of initial specified value Leakage current : \leq initial specified value</p>																											
Vibration Rating	10-55Hz, 10g sinusoidal in three axis, 2 hours per axis.																											
Maximum Tightening Torque	<table border="1"> <thead> <tr> <th rowspan="2">Terminal Code</th> <th rowspan="2">Thread Size</th> <th colspan="2">3 Threads Engaged</th> <th colspan="2">6 Threads Engaged</th> </tr> <tr> <th>in-lb</th> <th>N·m</th> <th>in-lb</th> <th>N·m</th> </tr> </thead> <tbody> <tr> <td>CT</td> <td>M5x0.8</td> <td>18.0</td> <td>2.0</td> <td>28.5</td> <td>3.2</td> </tr> </tbody> </table>	Terminal Code	Thread Size	3 Threads Engaged		6 Threads Engaged		in-lb	N·m	in-lb	N·m	CT	M5x0.8	18.0	2.0	28.5	3.2											
Terminal Code	Thread Size			3 Threads Engaged		6 Threads Engaged																						
		in-lb	N·m	in-lb	N·m																							
CT	M5x0.8	18.0	2.0	28.5	3.2																							
Typical Inductance	25nH at 1MHz																											
Custom Designs	Custom CV values per case size may be available upon request. Contact appropriate representative with specific requirements.																											

Screw-Mount

Return Group Chart



LARGE CAPACITANCE ALUMINUM ELECTROLYTIC CAPACITORS (UNITED CHEMI-CON, INC. Products) Inverter-use screw terminal, 105°C

UTOR Series

Diagram of Dimensions - Screw Terminals

Toroidal Large Can/Screw Terminals

Unit: mm and inches

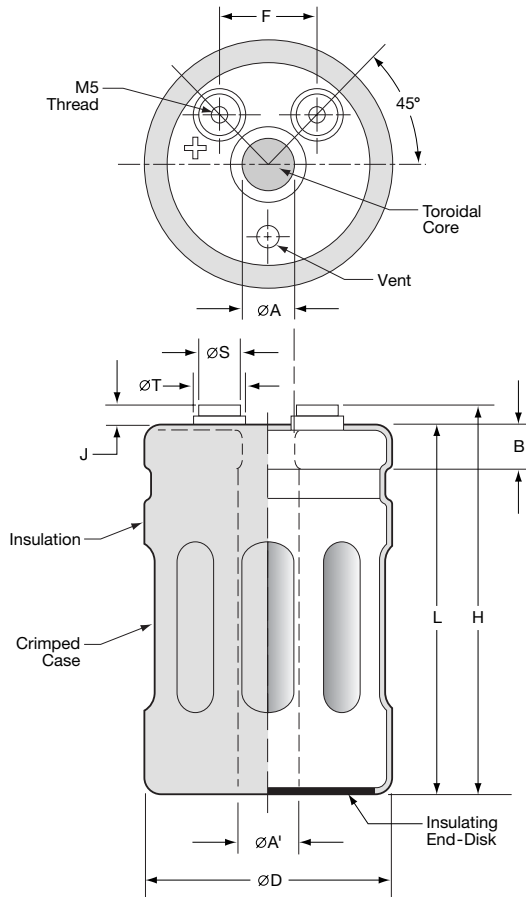

Terminal Specifications in Millimeters

Terminal Code	Thread Size	Minimum Thread Depth	J ±0.50	ØS ±0.25	ØT ±0.25
CT	M5x0.8	10.5	7.0	13.0	18.5

Terminal Specifications in Inches

Terminal Code	Thread Size	Minimum Thread Depth	J ±0.020	ØS ±0.010	ØT ±0.010
CT	M5x0.8	0.413	0.276	0.512	0.728

Case Dimensions in Millimeters

ØA ±0.20	ØA' ±0.30	B ±0.5	F ±0.25
16.3	18.9	9.5	31.8

Case Dimensions in Inches

ØA ±0.008	ØA' ±0.012	B ±0.020	F ±0.010
0.642	0.744	0.374	1.250

Case Size Code	ØD +2.0	L +2.0	H ±1.0
E54	76	54	61
E67	76	67	74
E79	76	79	86
E92	76	92	99
EA5	76	105	112
EB7	76	117	124
ED0	76	130	137
EE3	76	143	150
EF5	76	155	162
EG8	76	168	175

Case Size Code	ØD +0.080	L +0.080	H ±0.040
E54	3.000	2.125	2.402
E67	3.000	2.625	2.913
E79	3.000	3.125	3.386
E92	3.000	3.625	3.898
EA5	3.000	4.125	4.409
EB7	3.000	4.625	4.882
ED0	3.000	5.125	5.394
EE3	3.000	5.625	5.906
EF5	3.000	6.125	6.378
EG8	3.000	6.625	6.890

Return Group Chart



LARGE CAPACITANCE ALUMINUM ELECTROLYTIC CAPACITORS (UNITED CHEMI-CON, INC. Products) Inverter-use screw terminal, 105°C

UTOR Series

Mounting Hardware - Screw Terminals

Type C: Three-Footed Clamp

Unit: mm (inches)

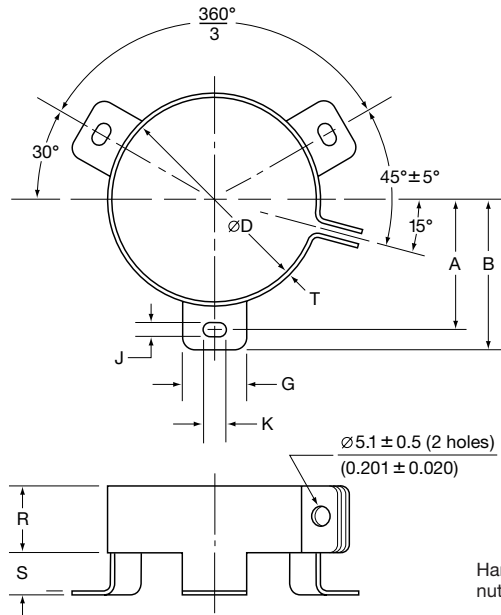

Hardware: Screw, washer and hexagon nut included with each clamp.

Type C: Clamp Specifications

Mounting Code	Case $\varnothing D$	A ± 1.0 (0.040)	B ± 1.0 (0.040)	G ± 1.0 (0.040)	J ± 0.5 (0.020)	K ± 0.5 (0.020)	R ± 1.0 (0.040)	S ± 1.0 (0.040)	T ± 0.5 (0.020)
C	76.2 (3.000)	44.5 (1.750)	49.2 (1.937)	13.3 (0.524)	4.5 (0.177)	7.1 (0.280)	19.1 (0.751)	9.5 (0.374)	1.0 (0.040)

Return Group Chart



LARGE CAPACITANCE ALUMINUM ELECTROLYTIC CAPACITORS (UNITED CHEMI-CON, INC. Products) Inverter-use screw terminal, 105°C

UTOR Series

Mounting Hardware - Screw Terminals

Type H: Heat Sink Mounting Kit

Unit: mm (inches)

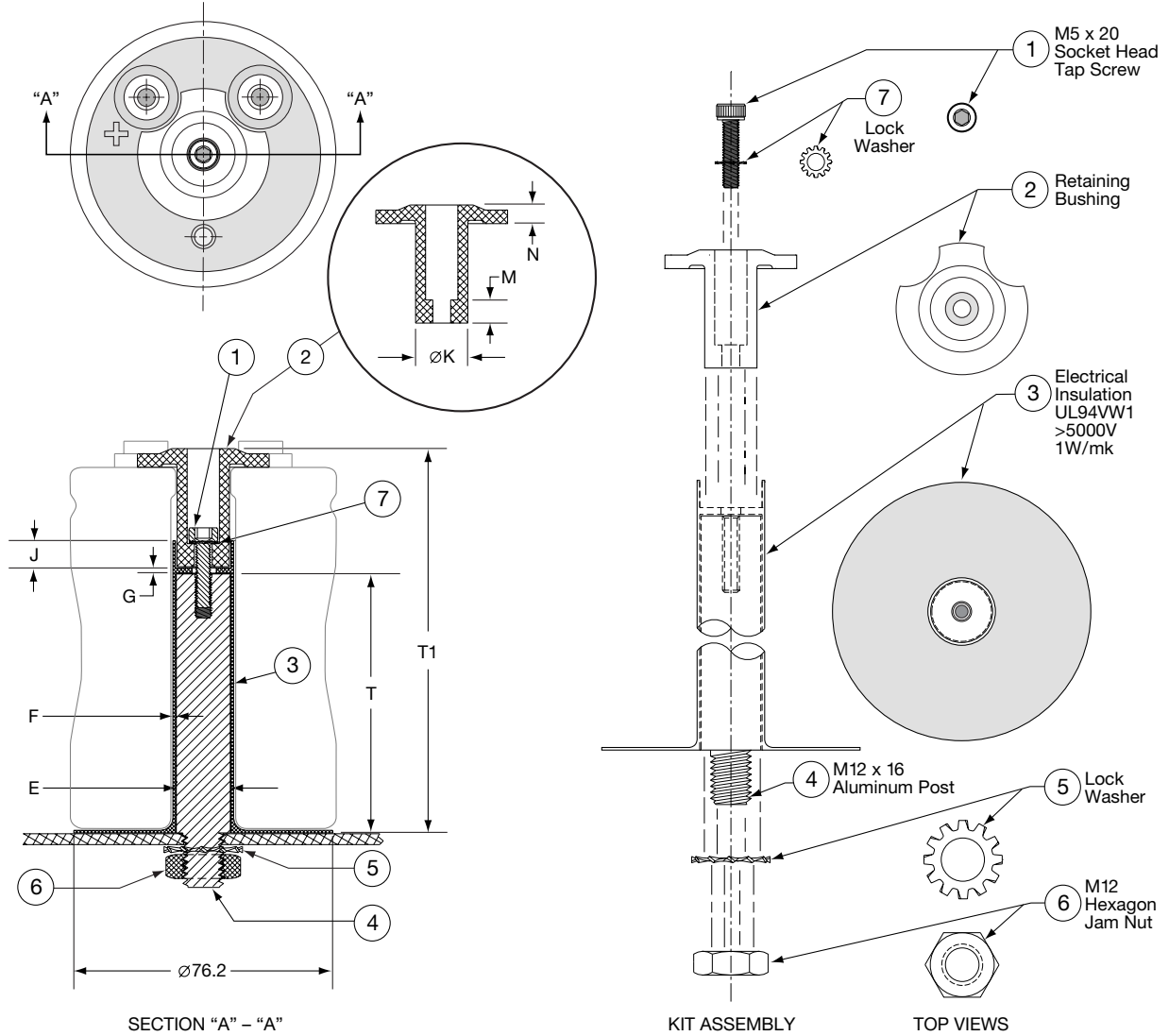

Type H: Heat Sink Mounting Kit Dimensions

Mounting Code	Case Size Code	T ± 0.2 (0.008)	T1 ± 0.5 (0.020)
H	E54	35 (1.378)	58 (2.280)
H	E67	35 (1.378)	71 (2.780)
H	E79	60 (2.362)	83 (3.280)
H	E92	60 (2.362)	96 (3.780)
H	EA5	60 (2.362)	109 (4.280)
H	EB7	60 (2.362)	121 (4.780)
H	ED0	111 (4.370)	134 (5.280)
H	EE3	111 (4.370)	147 (5.780)
H	EF5	111 (4.370)	160 (6.280)
H	EG8	111 (4.370)	172 (6.780)

Dimension	Millimeters	Inches
E	18.6 Max.	0.732 Max.
F	0.56 ± 0.05	0.022 ± 0.002
G	2.00 ± 0.13	0.080 ± 0.005
J	8.00 ± 0.13	0.315 ± 0.005
øK	15.24 ± 0.20	0.600 ± 0.008
M	6.76 ± 0.13	0.266 ± 0.005
N	5.49 ± 0.13	0.216 ± 0.005



UTOR Series

Part Numbering System for UTOR Series When ordering, always specify complete 18-field global part number.

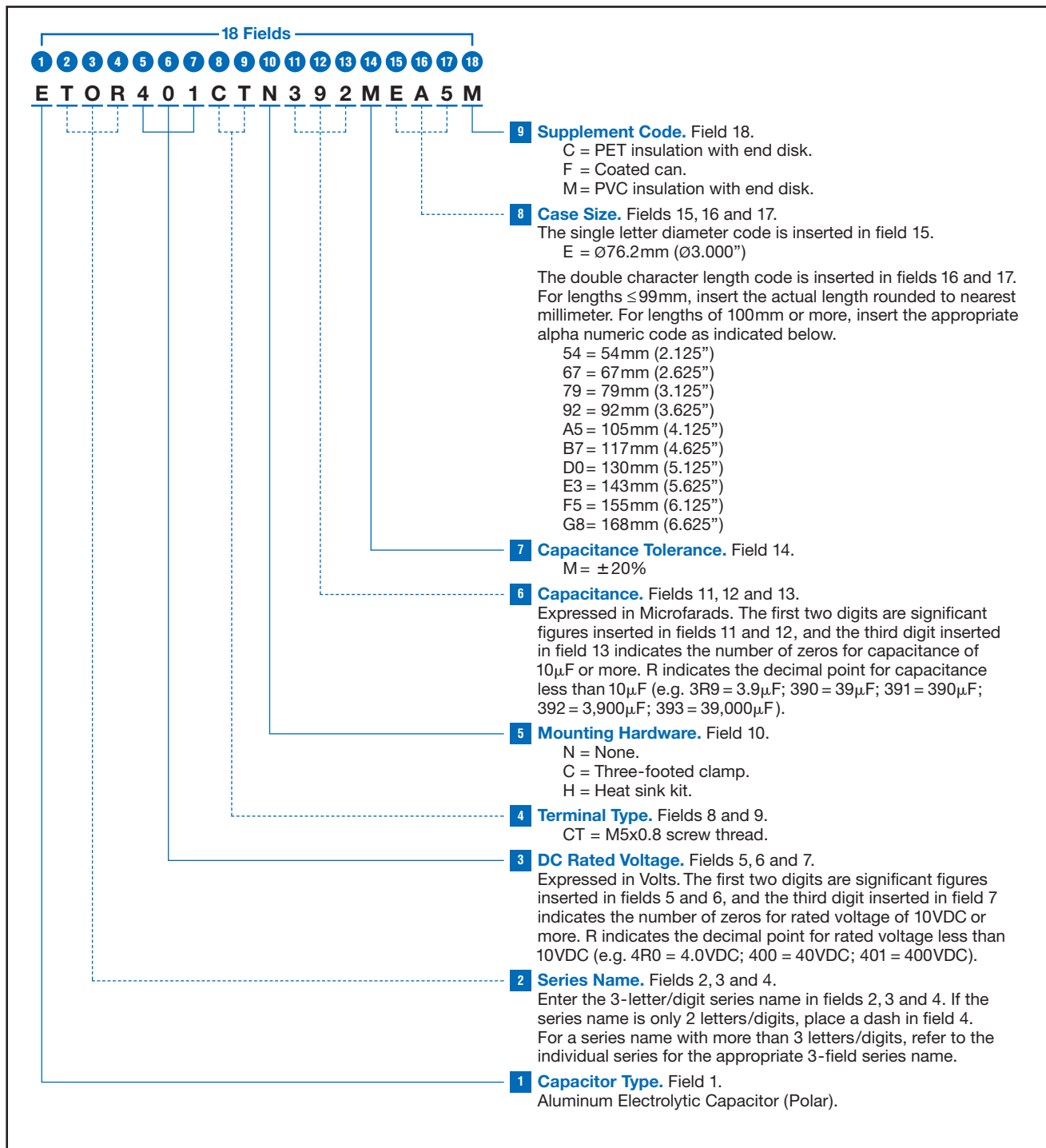

Screw-Mount

Return Group Chart



LARGE CAPACITANCE ALUMINUM ELECTROLYTIC CAPACITORS (UNITED CHEMI-CON, INC. Products) Inverter-use screw terminal, 105°C

UTOR Series

Standard Voltage Ratings - Screw Terminals

Rated Voltage (WVDC)	Capacitance (μF)	Global Part Number†	Nominal Case Size* D × L (mm)	Case Size Code	Maximum ESR (mΩ) at +25°C, 120Hz	Rated Ripple Current (A rms) at +105°C		
						120Hz	300Hz	>3kHz
350 Volts 400 Volts Surge	1,800	ETOR351CTN182ME54M	76 × 54	E54	44	11.8	14.1	16.5
	2,700	ETOR351CTN272ME67M	76 × 67	E67	30	15.4	18.5	21.6
	3,300	ETOR351CTN332ME79M	76 × 79	E79	24	17.1	20.5	23.9
	4,700	ETOR351CTN472ME92M	76 × 92	E92	17	21.6	26.0	30.3
	5,600	ETOR351CTN562MEA5M	76 × 105	EA5	14	24.9	29.9	34.9
	6,800	ETOR351CTN682MED0M	76 × 130	ED0	12	30.2	36.2	42.2
	8,200	ETOR351CTN822MEE3M	76 × 143	EE3	10	34.5	41.4	48.3
	10,000	ETOR351CTN103MEG8M	76 × 168	EG8	8	41.0	49.2	57.4
400 Volts 450 Volts Surge	1,500	ETOR401CTN152ME54M	76 × 54	E54	53	10.7	12.9	15.0
	2,200	ETOR401CTN222ME67M	76 × 67	E67	36	13.9	16.7	19.5
	2,700	ETOR401CTN272ME79M	76 × 79	E79	30	15.4	18.5	21.6
	3,300	ETOR401CTN332ME92M	76 × 92	E92	24	18.1	21.8	25.4
	3,900	ETOR401CTN392MEA5M	76 × 105	EA5	21	20.8	25.0	29.1
	4,700	ETOR401CTN472MEB7M	76 × 117	EB7	17	24.0	28.8	33.6
	5,600	ETOR401CTN562MED0M	76 × 130	ED0	14	27.4	32.9	38.3
	6,800	ETOR401CTN682MEE3M	76 × 143	EE3	12	31.4	37.7	44.0
	8,200	ETOR401CTN822MEG8M	76 × 168	EG8	10	37.1	44.5	52.0
420 Volts 470 Volts Surge	1,200	ETOR421CTN122ME54M	76 × 54	E54	89	9.3	11.1	13.0
	1,800	ETOR421CTN182ME67M	76 × 67	E67	59	12.2	14.6	17.1
	2,200	ETOR421CTN222ME79M	76 × 79	E79	40	14.9	17.9	20.9
	3,300	ETOR421CTN332ME92M	76 × 92	E92	32	17.5	21.0	24.5
	3,900	ETOR421CTN392MEA5M	76 × 105	EA5	27	20.1	24.1	28.2
	4,700	ETOR421CTN472MED0M	76 × 130	ED0	23	24.2	29.1	33.9
	5,600	ETOR421CTN562MEE3M	76 × 143	EE3	19	27.6	33.1	38.6
	6,800	ETOR421CTN682MEG8M	76 × 168	EG8	16	32.7	39.2	45.7
450 Volts 500 Volts Surge	1,000	ETOR451CTN102ME54M	76 × 54	E54	89	9.3	11.1	13.0
	1,500	ETOR451CTN152ME67M	76 × 67	E67	59	12.2	14.6	17.1
	2,200	ETOR451CTN222ME79M	76 × 79	E79	48	13.5	16.2	18.9
	2,700	ETOR451CTN272ME92M	76 × 92	E92	40	15.9	19.0	22.2
	3,300	ETOR451CTN332MEA5M	76 × 105	EA5	32	18.5	22.2	25.9
	3,900	ETOR451CTN392MEB7M	76 × 117	EB7	27	21.1	25.3	29.6
	4,700	ETOR451CTN472MED0M	76 × 130	ED0	23	24.2	29.1	33.9
	5,600	ETOR451CTN562MEF5M	76 × 155	EF5	19	28.6	34.3	40.1
500 Volts 550 Volts Surge	680	ETOR501CTN681ME54M	76 × 54	E54	206	6.5	7.8	9.1
	1,000	ETOR501CTN102ME67M	76 × 67	E67	140	8.4	10.1	11.8
	1,500	ETOR501CTN152ME79M	76 × 79	E79	93	10.3	12.4	14.4
	1,800	ETOR501CTN182ME92M	76 × 92	E92	78	12.0	14.4	16.8
	2,200	ETOR501CTN222MEA5M	76 × 105	EA5	64	14.0	16.8	19.6
	2,700	ETOR501CTN272MEB7M	76 × 117	EB7	52	16.3	19.5	22.8
	3,300	ETOR501CTN332MEE3M	76 × 143	EE3	42	19.6	23.5	27.4
	3,900	ETOR501CTN392MEG8M	76 × 168	EG8	36	22.1	26.5	31.0

†For mounting and construction options, refer to the part numbering system for descriptions and codes.

*Refer to diagram of dimensions for detailed case size specifications.

Return Group Chart



Aluminum Electrolytic Capacitors for Audio

Surface Mount, 85°C

Alchip™-MAR Series

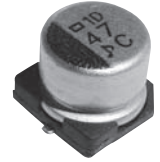

- Suitable for small and low profile product such as the car audio and electronics
- Non solvent resistant type
- RoHS Compliant

◆ SPECIFICATIONS

Items	Characteristics							
Category	-40 to +85°C							
Temperature Range	-40 to +85°C							
Rated Voltage Range	6.3 to 50V _{dc}							
Capacitance Tolerance	±20% (M) (at 20°C, 120Hz)							
Leakage Current	I=0.01CV or 3μA, whichever is greater. Where, I : Max. leakage current (μA), C : Nominal capacitance (μF), V : Rated voltage (V) (at 20°C after 2 minutes)							
Dissipation Factor (tan δ)	Rated voltage (V _{dc})	6.3V	10V	16V	25V	35V	50V	
	tan δ (Max.)	D55 to F55	0.30	0.24	0.20	0.16	0.14	0.12
		H63 to JA0	0.40	0.30	0.26	0.16	0.14	0.12
Low Temperature Characteristics (Max. Impedance Ratio)	Rated voltage (V _{dc})	6.3V	10V	16V	25V	35V	50V	
	Z(-25°C)/Z(+20°C)	4	3	2	2	2	2	
	Z(-40°C)/Z(+20°C)	12	8	6	4	3	3	
		(at 120Hz)						
Endurance	The following specifications shall be satisfied when the capacitors are restored to 20°C after the rated voltage is applied for 2,000 hours at 85°C.							
	Capacitance change	≤ ±20% of the initial value						
	D.F. (tan δ)	≤ 200% of the initial specified value						
	Leakage current	≤ The initial specified value						
Shelf Life	The following specifications shall be satisfied when the capacitors are restored to 20°C after exposing them for 500 hours at 85°C without voltage applied. Before the measurement, the capacitor shall be preconditioned by applying voltage according to Item 4.1 of JIS C 5101-4.							
	Capacitance change	≤ ±20% of the initial value						
	D.F. (tan δ)	≤ 200% of the initial specified value						
	Leakage current	≤ The initial specified value						

◆ DIMENSIONS [mm]

● Terminal Code : A

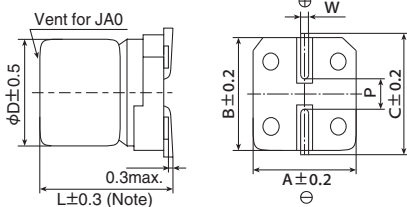

Note : L±0.5 for H63 to JA0

Size code	D	L	A	B	C	W	P
D55	4	5.2	4.3	4.3	5.1	0.5 to 0.8	1.0
E55	5	5.2	5.3	5.3	5.9	0.5 to 0.8	1.4
F55	6.3	5.2	6.6	6.6	7.2	0.5 to 0.8	1.9
H63	8	6.3	8.3	8.3	9.0	0.5 to 0.8	2.3
HA0	8	10.0	8.3	8.3	9.0	0.7 to 1.1	3.1
JA0	10	10.0	10.3	10.3	11.0	0.7 to 1.1	4.5

◆ MARKING

EX) 16V47μF



● Rated voltage symbol

Rated voltage (V _{dc})	Symbol
6.3	j
10	A
16	C
25	E
35	V
50	H

◆ PART NUMBERING SYSTEM

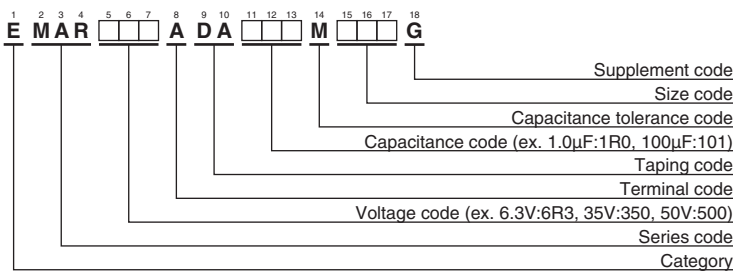

Please refer to "Product code guide (surface mount type)"

Return Group Chart



Aluminum Electrolytic Capacitors for Audio

Surface Mount, 85°C

Alchip™ - **MAR** Series

◆ **STANDARD RATINGS**

WV (V _{dc})	Cap (μF)	Size Code	tan δ	Part No.	WV (V _{dc})	Cap (μF)	Size Code	tan δ	Part No.
6.3	22	D55	0.30	EMAR6R3ADA220MD55G	25	4.7	D55	0.16	EMAR250ADA4R7MD55G
	33	E55	0.30	EMAR6R3ADA330ME55G		10	E55	0.16	EMAR250ADA100ME55G
	47	E55	0.30	EMAR6R3ADA470ME55G		22	F55	0.16	EMAR250ADA220MF55G
	100	F55	0.30	EMAR6R3ADA101MF55G		33	F55	0.16	EMAR250ADA330MF55G
	220	H63	0.40	EMAR6R3ADA221MH63G		47	H63	0.16	EMAR250ADA470MH63G
	330	H63	0.40	EMAR6R3ADA331MH63G		100	H63	0.16	EMAR250ADA101MH63G
	470	HA0	0.40	EMAR6R3ADA471MHA0G		220	HA0	0.16	EMAR250ADA221MHA0G
1,000	JA0	0.40	EMAR6R3ADA102MJA0G	330	JA0	0.16	EMAR250ADA331MJA0G		
10	10	D55	0.24	EMAR100ADA100MD55G	35	3.3	D55	0.14	EMAR350ADA3R3MD55G
	22	E55	0.24	EMAR100ADA220ME55G		4.7	D55	0.14	EMAR350ADA4R7MD55G
	33	E55	0.24	EMAR100ADA330ME55G		10	E55	0.14	EMAR350ADA100ME55G
	47	F55	0.24	EMAR100ADA470MF55G		22	F55	0.14	EMAR350ADA220MF55G
	100	F55	0.24	EMAR100ADA101MF55G		33	H63	0.14	EMAR350ADA330MH63G
	220	H63	0.30	EMAR100ADA221MH63G		47	H63	0.14	EMAR350ADA470MH63G
	330	HA0	0.30	EMAR100ADA331MHA0G		100	HA0	0.14	EMAR350ADA101MHA0G
470	JA0	0.30	EMAR100ADA471MJA0G	220	JA0	0.14	EMAR350ADA221MJA0G		
16	4.7	D55	0.20	EMAR160ADA4R7MD55G	50	1.0	D55	0.12	EMAR500ADA1R0MD55G
	10	D55	0.20	EMAR160ADA100MD55G		2.2	D55	0.12	EMAR500ADA2R2MD55G
	22	E55	0.20	EMAR160ADA220ME55G		3.3	D55	0.12	EMAR500ADA3R3MD55G
	33	F55	0.20	EMAR160ADA330MF55G		4.7	E55	0.12	EMAR500ADA4R7ME55G
	47	F55	0.20	EMAR160ADA470MF55G		10	F55	0.12	EMAR500ADA100MF55G
	100	H63	0.26	EMAR160ADA101MH63G		22	H63	0.12	EMAR500ADA220MH63G
	220	HA0	0.26	EMAR160ADA221MHA0G		33	H63	0.12	EMAR500ADA330MH63G
	330	HA0	0.26	EMAR160ADA331MHA0G		47	HA0	0.12	EMAR500ADA470MHA0G
	470	JA0	0.26	EMAR160ADA471MJA0G		100	JA0	0.12	EMAR500ADA101MJA0G

Return Group Chart



Aluminum Electrolytic Capacitors for Audio

Surface Mount, 105°C

Alchip™-MAK Series

- Suitable for small and low profile product such as the car audio and electronics
- Non solvent resistant type
- RoHS Compliant



◆ SPECIFICATIONS

Items	Characteristics							
Category	-40 to +105°C							
Temperature Range	-40 to +105°C							
Rated Voltage Range	6.3 to 50V _{dc}							
Capacitance Tolerance	±20% (M) (at 20°C, 120Hz)							
Leakage Current	I=0.01CV or 3μA, whichever is greater. Where, I : Max. leakage current (μA), C : Nominal capacitance (μF), V : Rated voltage (V) (at 20°C after 2 minutes)							
Dissipation Factor (tan δ)	Rated voltage (V _{dc})	6.3V	10V	16V	25V	35V	50V	
	tan δ (Max.)	0.30	0.26	0.22	0.16	0.13	0.12	
Low Temperature Characteristics (Max. Impedance Ratio)	Rated voltage (V _{dc})	6.3V	10V	16V	25V	35V	50V	
	Z(-25°C)/Z(+20°C)	4	3	2	2	2	2	
	Z(-40°C)/Z(+20°C)	8	5	4	3	3	3	
Endurance	The following specifications shall be satisfied when the capacitors are restored to 20°C after the rated voltage is applied for 1,000 hours at 105°C.							
	Size code	D55 to F55			H63 to JA0			
	Capacitance change	≤ ±30% of the initial value			≤ ±20% of the initial value			
	D.F. (tan δ)	≤200% of the initial specified value			≤200% of the initial specified value			
	Leakage current	≤The initial specified value			≤The initial specified value			
Shelf Life	The following specifications shall be satisfied when the capacitors are restored to 20°C after exposing them for 1,000 hours at 105°C without voltage applied. Before the measurement, the capacitor shall be preconditioned by applying voltage according to Item 4.1 of JIS C 5101-4.							
	Size code	D55 to F55			H63 to JA0			
	Capacitance change	≤ ±30% of the initial value			≤ ±20% of the initial value			
	D.F. (tan δ)	≤200% of the initial specified value			≤200% of the initial specified value			
	Leakage current	≤The initial specified value			≤The initial specified value			

◆ DIMENSIONS [mm]

- Terminal Code : A

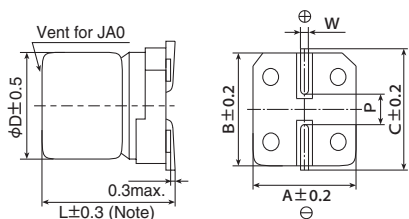

Note : L±0.5 for H63 to JA0

Size code	D	L	A	B	C	W	P
D55	4	5.2	4.3	4.3	5.1	0.5 to 0.8	1.0
E55	5	5.2	5.3	5.3	5.9	0.5 to 0.8	1.4
F55	6.3	5.2	6.6	6.6	7.2	0.5 to 0.8	1.9
H63	8	6.3	8.3	8.3	9.0	0.5 to 0.8	2.3
HA0	8	10.0	8.3	8.3	9.0	0.7 to 1.1	3.1
JA0	10	10.0	10.3	10.3	11.0	0.7 to 1.1	4.5

◆ MARKING

EX) 10V100μF



- Rated voltage symbol

Rated voltage (V _{dc})	Symbol
6.3	j
10	A
16	C
25	E
35	V
50	H

◆ PART NUMBERING SYSTEM

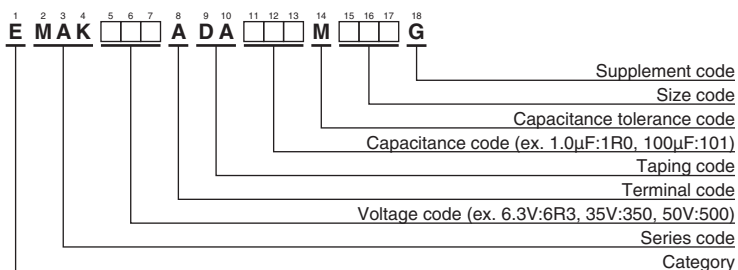

Please refer to "Product code guide (surface mount type)"

Return Group Chart



Aluminum Electrolytic Capacitors for Audio

Surface Mount, 105°C

Alchip™ - **MAK** Series

◆ **STANDARD RATINGS**

WV (V _{dc})	Cap (μF)	Size Code	tan δ	Part No.	WV (V _{dc})	Cap (μF)	Size Code	tan δ	Part No.
6.3	22	D55	0.30	EMAK6R3ADA220MD55G	25	4.7	D55	0.16	EMAK250ADA4R7MD55G
	33	E55	0.30	EMAK6R3ADA330ME55G		10	E55	0.16	EMAK250ADA100ME55G
	47	E55	0.30	EMAK6R3ADA470ME55G		22	F55	0.16	EMAK250ADA220MF55G
	100	F55	0.30	EMAK6R3ADA101MF55G		33	F55	0.16	EMAK250ADA330MF55G
	220	H63	0.30	EMAK6R3ADA221MH63G		47	H63	0.16	EMAK250ADA470MH63G
	330	H63	0.30	EMAK6R3ADA331MH63G		100	HA0	0.16	EMAK250ADA101MHA0G
	470	HA0	0.30	EMAK6R3ADA471MHA0G		330	JA0	0.16	EMAK250ADA331MJA0G
	1,000	JA0	0.30	EMAK6R3ADA102MJA0G		35	4.7	D55	0.13
10	22	E55	0.26	EMAK100ADA220ME55G	10		E55	0.13	EMAK350ADA100ME55G
	33	E55	0.26	EMAK100ADA330ME55G	22		F55	0.13	EMAK350ADA220MF55G
	47	F55	0.26	EMAK100ADA470MF55G	33		H63	0.13	EMAK350ADA330MH63G
	100	F55	0.26	EMAK100ADA101MF55G	47		HA0	0.13	EMAK350ADA470MHA0G
	220	H63	0.26	EMAK100ADA221MH63G	100		JA0	0.13	EMAK350ADA101MJA0G
	330	HA0	0.26	EMAK100ADA331MHA0G	220		JA0	0.13	EMAK350ADA221MJA0G
	470	JA0	0.26	EMAK100ADA471MJA0G	50		1.0	D55	0.12
	16	10	D55	0.22		EMAK160ADA100MD55G	2.2	D55	0.12
22		E55	0.22	EMAK160ADA220ME55G		3.3	D55	0.12	EMAK500ADA3R3MD55G
47		F55	0.22	EMAK160ADA470MF55G		4.7	E55	0.12	EMAK500ADA4R7ME55G
100		H63	0.22	EMAK160ADA101MH63G		10	F55	0.12	EMAK500ADA100MF55G
220		HA0	0.22	EMAK160ADA221MHA0G		22	H63	0.12	EMAK500ADA220MH63G
330		HA0	0.22	EMAK160ADA331MHA0G		33	HA0	0.12	EMAK500ADA330MHA0G
470		JA0	0.22	EMAK160ADA471MJA0G		47	HA0	0.12	EMAK500ADA470MHA0G
						100	JA0	0.12	EMAK500ADA101MJA0G

Return Group Chart



Aluminum Electrolytic Capacitors for Audio

5mm 7mm height, 85°C

ARI Series

- Suitable for small and low profile product such as the car audio and electronics
- Non solvent resistant type
- RoHS Compliant



◆ SPECIFICATIONS

Items	Characteristics							
Category	-40 to +85°C							
Temperature Range	-40 to +85°C							
Rated Voltage Range	6.3 to 50V _{dc}							
Capacitance Tolerance	±20% (M) (at 20°C, 120Hz)							
Leakage Current	I=0.01CV or 3μA, whichever is greater. Where, I : Max. leakage current (μA), C : Nominal capacitance (μF), V : Rated voltage (V) (at 20°C after 2 minutes)							
Dissipation Factor (tan δ)	Rated voltage (V _{dc})	6.3V	10V	16V	25V	35V	50V	
	tan δ (Max.)	5L	0.27	0.23	0.18	0.16	0.14	0.12
		7L	0.35	0.27	0.22	0.20	0.17	0.15
Low Temperature Characteristics (Max. Impedance Ratio)	Rated voltage (V _{dc})	6.3V	10V	16V	25V	35V	50V	
	Z(-25°C)/Z(+20°C)	4	3	2	2	2	2	
	Z(-40°C)/Z(+20°C)	10	8	6	4	3	3	
Endurance	The following specifications shall be satisfied when the capacitors are restored to 20°C after the rated voltage is applied for 1,000 hours at 85°C.							
	Capacitance change	≤ ±20% of the initial value						
	D.F. (tan δ)	≤ 200% of the initial specified value						
	Leakage current	≤ The initial specified value						
Shelf Life	The following specifications shall be satisfied when the capacitors are restored to 20°C after exposing them for 500 hours at 85°C without voltage applied. Before the measurement, the capacitor shall be preconditioned by applying voltage according to Item 4.1 of JIS C 5101-4.							
	Capacitance change	≤ ±20% of the initial value						
	D.F. (tan δ)	≤ 200% of the initial specified value						
	Leakage current	≤ The initial specified value						

◆ DIMENSIONS [mm]

- Terminal Code : E

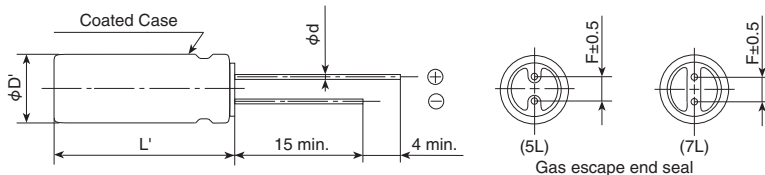

φD (L)	4	5	6.3	8	
				(5L)	(7L)
F	1.5	2.0	2.5	2.5	3.5
φd	0.45	0.45	0.45	0.45	
φD'	φD + 0.5 max.				
L'	L + 1.0 max.				

◆ PART NUMBERING SYSTEM

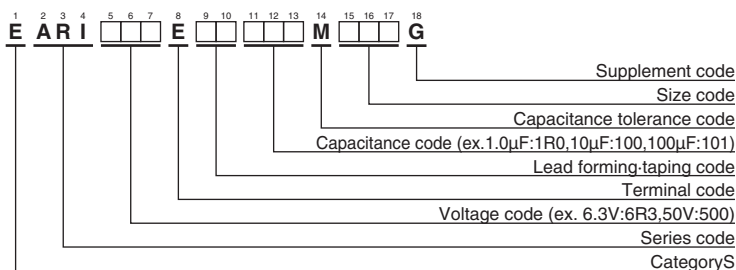

Please refer to "Product code guide (radial lead type)"

◆ MARKING

EX) 16V47μF



● Rated voltage symbol

Rated voltage (V _{dc})	Symbol
6.3	j
10	A
16	C
25	E
35	V
50	H

Return Group Chart



Aluminum Electrolytic Capacitors for Audio

5mm 7mm height, 85°C

ARISeries

◆ **STANDARD RATINGS**

WV (V _{dc})	Cap (μF)	Case size φD×L(mm)	tan δ	Part No.	WV (V _{dc})	Cap (μF)	Case size φD×L(mm)	tan δ	Part No.
6.3	22	4×5	0.27	EARI6R3E□□220MD05G	35	4.7	4×5	0.14	EARI350E□□4R7MD05G
	22	4×7	0.35	EARI6R3E□□220MD07G		4.7	4×7	0.17	EARI350E□□4R7MD07G
	47	5×5	0.27	EARI6R3E□□470ME05G		10	5×5	0.14	EARI350E□□100ME05G
	47	5×7	0.35	EARI6R3E□□470ME07G		10	5×7	0.17	EARI350E□□100ME07G
	220	6.3×7	0.35	EARI6R3E□□221MF07G		22	6.3×5	0.14	EARI350E□□220MF05G
	330	8×5	0.27	EARI6R3E□□331MH05G		22	6.3×7	0.17	EARI350E□□220MF07G
10	33	5×5	0.23	EARI100E□□330ME05G	33	8×5	0.14	EARI350E□□330MH05G	
	33	5×7	0.27	EARI100E□□330ME07G	50	1.0	4×5	0.12	EARI500E□□1R0MD05G
	100	6.3×5	0.23	EARI100E□□101MF05G		1.0	4×7	0.15	EARI500E□□1R0MD07G
	220	8×5	0.23	EARI100E□□221MH05G		2.2	4×5	0.12	EARI500E□□2R2MD05G
16	10	4×5	0.18	EARI160E□□100MD05G		2.2	4×7	0.15	EARI500E□□2R2MD07G
	10	4×7	0.22	EARI160E□□100MD07G		3.3	4×5	0.12	EARI500E□□3R3MD05G
	22	5×5	0.18	EARI160E□□220ME05G		3.3	4×7	0.15	EARI500E□□3R3MD07G
	22	5×7	0.22	EARI160E□□220ME07G		4.7	5×5	0.12	EARI500E□□4R7ME05G
	47	6.3×7	0.22	EARI160E□□470MF07G		4.7	5×7	0.15	EARI500E□□4R7ME07G
	100	6.3×7	0.22	EARI160E□□101MF07G		10	6.3×5	0.12	EARI500E□□100MF05G
25	33	6.3×5	0.16	EARI250E□□330MF05G		10	6.3×7	0.15	EARI500E□□100MF07G
	33	6.3×7	0.20	EARI250E□□330MF07G	22	8×5	0.12	EARI500E□□220MH05G	
	47	6.3×5	0.16	EARI250E□□470MF05G					
	100	8×5	0.16	EARI250E□□101MH05G					

□□ : Enter the appropriate lead forming or taping code.

Return Group Chart



Aluminum Electrolytic Capacitors for Audio

Standard, Downsized, 85°C

ASG Series

- Non solvent resistant type
- RoHS Compliant



◆ SPECIFICATIONS

Items	Characteristics	
Category	-40 to +85°C	
Temperature Range	-40 to +85°C	
Rated Voltage Range	6.3 to 100V _{ac}	
Capacitance Tolerance	±20% (M) (at 20°C, 120Hz)	
Leakage Current	I=0.01CV or 3μA, whichever is greater. Where, I : Max. leakage current (μA), C : Nominal capacitance (μF), V : Rated voltage (V) (at 20°C after 2 minutes)	
Dissipation Factor (tan δ)	Rated voltage (V _{ac})	6.3V 10V 16V 25V 35V 50V 63V 100V
	tan δ (Max.)	0.34 0.24 0.20 0.16 0.14 0.12 0.10 0.08
When nominal capacitance exceeds 1,000μF, add 0.02 to the value above for each 1,000μF increase. (at 20°C, 120Hz)		
Low Temperature Characteristics (Max. Impedance Ratio)	Rated voltage (V _{ac})	6.3V 10V 16V 25V 35V 50V 63V 100V
	Z(-25°C)/Z(+20°C)	5 4 3 2 2 2 2 2
	Z(-40°C)/Z(+20°C)	12 10 8 5 4 3 3 3
(at 120Hz)		
Endurance	The following specifications shall be satisfied when the capacitors are restored to 20°C after the rated voltage is applied for 2,000 hours at 85°C.	
	Capacitance change	≤ ±20% of the initial value
	D.F. (tan δ)	≤ 200% of the initial specified value
	Leakage current	≤ The initial specified value
Shelf Life	The following specifications shall be satisfied when the capacitors are restored to 20°C after exposing them for 500 hours at 85°C without voltage applied. Before the measurement, the capacitor shall be preconditioned by applying voltage according to Item 4.1 of JIS C 5101-4.	
	Capacitance change	≤ ±20% of the initial value
	D.F. (tan δ)	≤ 200% of the initial specified value
	Leakage current	≤ The initial specified value

◆ DIMENSIONS [mm]

- Terminal Code : E

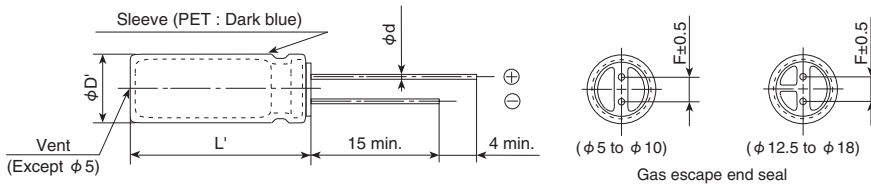

φD	5	6.3	8	10	12.5	16	18
φd	0.5	0.5	0.6	0.6	0.6	0.8	0.8
F	2.0	2.5	3.5	5.0	5.0	7.5	7.5
φD'	φD + 0.5 max.						
L'	L + 1.5 max.						

◆ PART NUMBERING SYSTEM

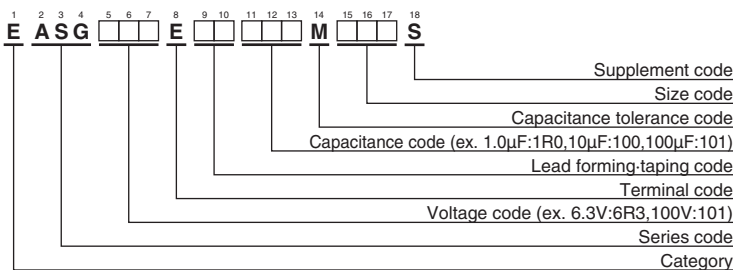

Please refer to "Product code guide (radial lead type)"

Return Group Chart



Aluminum Electrolytic Capacitors for Audio

Standard, Downsized, 85°C

ASG Series

◆ STANDARD RATINGS

WV (V _{dc})	Cap (μF)	Case size φD×L(mm)	tan δ	Part No.	WV (V _{dc})	Cap (μF)	Case size φD×L(mm)	tan δ	Part No.
6.3	330	6.3 × 11	0.34	EASG6R3E□□331MF11S	50	1.0	5 × 11	0.12	EASG500E□□1R0ME11S
	470	6.3 × 11	0.34	EASG6R3E□□471MF11S		2.2	5 × 11	0.12	EASG500E□□2R2ME11S
	1,000	8 × 11.5	0.34	EASG6R3E□□102MHB5S		3.3	5 × 11	0.12	EASG500E□□3R3ME11S
	2,200	10 × 20	0.36	EASG6R3E□□222MJ20S		4.7	5 × 11	0.12	EASG500E□□4R7ME11S
	3,300	10 × 20	0.38	EASG6R3E□□332MJ20S		10	5 × 11	0.12	EASG500E□□100ME11S
	4,700	12.5 × 20	0.40	EASG6R3E□□472MK20S		22	5 × 11	0.12	EASG500E□□220ME11S
	6,800	12.5 × 25	0.44	EASG6R3E□□682MK25S		33	5 × 11	0.12	EASG500E□□330ME11S
	10,000	16 × 25	0.52	EASG6R3E□□103ML25S		47	6.3 × 11	0.12	EASG500E□□470MF11S
	15,000	16 × 35.5	0.62	EASG6R3E□□153MLP1S		100	8 × 11.5	0.12	EASG500E□□101MHB5S
	22,000	18 × 40	0.76	EASG6R3E□□223MM40S		220	10 × 12.5	0.12	EASG500E□□221MJC5S
10	220	5 × 11	0.24	EASG100E□□221ME11S	330	10 × 16	0.12	EASG500E□□331MJ16S	
	330	6.3 × 11	0.24	EASG100E□□331MF11S	470	10 × 20	0.12	EASG500E□□471MJ20S	
	470	6.3 × 11	0.24	EASG100E□□471MF11S	1,000	12.5 × 25	0.12	EASG500E□□102MK25S	
	1,000	10 × 12.5	0.24	EASG100E□□102MJC5S	2,200	16 × 35.5	0.14	EASG500E□□222MLP1S	
	2,200	10 × 20	0.26	EASG100E□□222MJ20S	3,300	18 × 35.5	0.16	EASG500E□□332MMP1S	
	3,300	12.5 × 20	0.28	EASG100E□□332MK20S	63	10	5 × 11	0.10	EASG630E□□100ME11S
	4,700	12.5 × 25	0.30	EASG100E□□472MK25S		22	5 × 11	0.10	EASG630E□□220ME11S
	6,800	16 × 25	0.34	EASG100E□□682ML25S		33	6.3 × 11	0.10	EASG630E□□330MF11S
	10,000	16 × 35.5	0.42	EASG100E□□103MLP1S		47	6.3 × 11	0.10	EASG630E□□470MF11S
	15,000	18 × 35.5	0.52	EASG100E□□153MMP1S		100	10 × 12.5	0.10	EASG630E□□101MJC5S
16	100	5 × 11	0.20	EASG160E□□101ME11S		220	10 × 16	0.10	EASG630E□□221MJ16S
	220	6.3 × 11	0.20	EASG160E□□221MF11S		330	10 × 20	0.10	EASG630E□□331MJ20S
	330	8 × 11.5	0.20	EASG160E□□331MHB5S		470	12.5 × 20	0.10	EASG630E□□471MK20S
	470	8 × 11.5	0.20	EASG160E□□471MHB5S		1,000	16 × 25	0.10	EASG630E□□102ML25S
	1,000	10 × 16	0.20	EASG160E□□102MJ16S		2,200	18 × 35.5	0.12	EASG630E□□222MMP1S
	2,200	12.5 × 20	0.22	EASG160E□□222MK20S	100	1.0	5 × 11	0.08	EASG101E□□1R0ME11S
	3,300	12.5 × 25	0.24	EASG160E□□332MK25S		2.2	5 × 11	0.08	EASG101E□□2R2ME11S
	4,700	16 × 25	0.26	EASG160E□□472ML25S		3.3	5 × 11	0.08	EASG101E□□3R3ME11S
	6,800	16 × 31.5	0.30	EASG160E□□682MLN3S		4.7	5 × 11	0.08	EASG101E□□4R7ME11S
	10,000	18 × 35.5	0.38	EASG160E□□103MMP1S		10	6.3 × 11	0.08	EASG101E□□100MF11S
25	47	5 × 11	0.16	EASG250E□□470ME11S		22	8 × 11.5	0.08	EASG101E□□220MHB5S
	100	6.3 × 11	0.16	EASG250E□□101MF11S		33	8 × 11.5	0.08	EASG101E□□330MHB5S
	220	8 × 11.5	0.16	EASG250E□□221MHB5S		47	10 × 12.5	0.08	EASG101E□□470MJC5S
	330	8 × 11.5	0.16	EASG250E□□331MHB5S		100	10 × 20	0.08	EASG101E□□101MJ20S
	470	10 × 12.5	0.16	EASG250E□□471MJC5S		220	12.5 × 25	0.08	EASG101E□□221MK25S
	1,000	10 × 20	0.16	EASG250E□□102MJ20S	330	12.5 × 25	0.08	EASG101E□□331MK25S	
	2,200	12.5 × 25	0.18	EASG250E□□222MK25S	470	16 × 25	0.08	EASG101E□□471ML25S	
	3,300	16 × 25	0.20	EASG250E□□332ML25S	1,000	18 × 40	0.08	EASG101E□□102MM40S	
	4,700	16 × 31.5	0.22	EASG250E□□472MLN3S					
	6,800	18 × 35.5	0.26	EASG250E□□682MMP1S					
35	47	5 × 11	0.14	EASG350E□□470ME11S					
	100	6.3 × 11	0.14	EASG350E□□101MF11S					
	220	8 × 11.5	0.14	EASG350E□□221MHB5S					
	330	10 × 12.5	0.14	EASG350E□□331MJC5S					
	470	10 × 16	0.14	EASG350E□□471MJ16S					
	1,000	12.5 × 20	0.14	EASG350E□□102MK20S					
	2,200	16 × 25	0.16	EASG350E□□222ML25S					
	3,300	16 × 35.5	0.18	EASG350E□□332MLP1S					
4,700	18 × 35.5	0.20	EASG350E□□472MMP1S						

□□ : Enter the appropriate lead forming or taping code.



ASH Series

- The oxide free copper lead wire and electrolyte on audio purpose are employed
- Non solvent resistant type
- RoHS Compliant

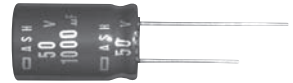

◆ SPECIFICATIONS

Items	Characteristics																											
Category	-40 to +85°C																											
Temperature Range	-40 to +85°C																											
Rated Voltage Range	6.3 to 100V _{dc}																											
Capacitance Tolerance	±20% (M) (at 20°C, 120Hz)																											
Leakage Current	I=0.03CV or 4µA, whichever is greater. (at 20°C after 1 minute) I=0.01CV or 3µA, whichever is greater. (at 20°C after 2 minutes) Where, I : Max. leakage current (µA), C : Nominal capacitance (µF), V : Rated voltage (V)																											
Dissipation Factor (tan δ)	<table border="1" style="width: 100%; border-collapse: collapse; text-align: center;"> <tr> <td>Rated voltage (V_{dc})</td> <td>6.3V</td><td>10V</td><td>16V</td><td>25V</td><td>35V</td><td>50V</td><td>63V</td><td>100V</td> </tr> <tr> <td>tan δ (Max.)</td> <td>0.26</td><td>0.22</td><td>0.18</td><td>0.16</td><td>0.14</td><td>0.12</td><td>0.10</td><td>0.10</td> </tr> </table> <p style="text-align: right; font-size: small;">When nominal capacitance exceeds 1,000µF, add 0.02 to the value above for each 1,000µF increase. (at 20°C, 120Hz)</p>	Rated voltage (V _{dc})	6.3V	10V	16V	25V	35V	50V	63V	100V	tan δ (Max.)	0.26	0.22	0.18	0.16	0.14	0.12	0.10	0.10									
Rated voltage (V _{dc})	6.3V	10V	16V	25V	35V	50V	63V	100V																				
tan δ (Max.)	0.26	0.22	0.18	0.16	0.14	0.12	0.10	0.10																				
Low Temperature Characteristics (Max. Impedance Ratio)	<table border="1" style="width: 100%; border-collapse: collapse; text-align: center;"> <tr> <td>Rated voltage (V_{dc})</td> <td>6.3V</td><td>10V</td><td>16V</td><td>25V</td><td>35V</td><td>50V</td><td>63V</td><td>100V</td> </tr> <tr> <td>Z(-25°C)/Z(+20°C)</td> <td>4</td><td>3</td><td>2</td><td>2</td><td>2</td><td>2</td><td>2</td><td>2</td> </tr> <tr> <td>Z(-40°C)/Z(+20°C)</td> <td>10</td><td>8</td><td>6</td><td>4</td><td>3</td><td>3</td><td>3</td><td>3</td> </tr> </table> <p style="text-align: right; font-size: small;">(at 120Hz)</p>	Rated voltage (V _{dc})	6.3V	10V	16V	25V	35V	50V	63V	100V	Z(-25°C)/Z(+20°C)	4	3	2	2	2	2	2	2	Z(-40°C)/Z(+20°C)	10	8	6	4	3	3	3	3
Rated voltage (V _{dc})	6.3V	10V	16V	25V	35V	50V	63V	100V																				
Z(-25°C)/Z(+20°C)	4	3	2	2	2	2	2	2																				
Z(-40°C)/Z(+20°C)	10	8	6	4	3	3	3	3																				
Endurance	<p>The following specifications shall be satisfied when the capacitors are restored to 20°C after the rated voltage is applied for 1,000 hours at 85°C.</p> <table border="1" style="width: 100%; border-collapse: collapse; text-align: center;"> <tr> <td>Capacitance change</td> <td>≤ ±20% of the initial value</td> </tr> <tr> <td>D.F. (tan δ)</td> <td>≤ 200% of the initial specified value</td> </tr> <tr> <td>Leakage current</td> <td>≤ The initial specified value</td> </tr> </table>	Capacitance change	≤ ±20% of the initial value	D.F. (tan δ)	≤ 200% of the initial specified value	Leakage current	≤ The initial specified value																					
Capacitance change	≤ ±20% of the initial value																											
D.F. (tan δ)	≤ 200% of the initial specified value																											
Leakage current	≤ The initial specified value																											
Shelf Life	<p>The following specifications shall be satisfied when the capacitors are restored to 20°C after exposing them for 500 hours at 85°C without voltage applied. Before the measurement, the capacitor shall be preconditioned by applying voltage according to Item 4.1 of JIS C 5101-4.</p> <table border="1" style="width: 100%; border-collapse: collapse; text-align: center;"> <tr> <td>Capacitance change</td> <td>≤ ±20% of the initial value</td> </tr> <tr> <td>D.F. (tan δ)</td> <td>≤ 200% of the initial specified value</td> </tr> <tr> <td>Leakage current</td> <td>≤ The initial specified value</td> </tr> </table>	Capacitance change	≤ ±20% of the initial value	D.F. (tan δ)	≤ 200% of the initial specified value	Leakage current	≤ The initial specified value																					
Capacitance change	≤ ±20% of the initial value																											
D.F. (tan δ)	≤ 200% of the initial specified value																											
Leakage current	≤ The initial specified value																											

◆ DIMENSIONS [mm]

- Terminal Code : E

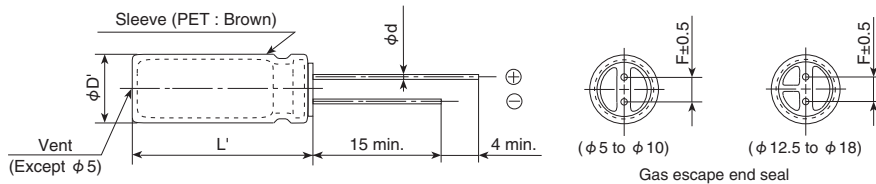

φD	5	6.3	8	10	12.5	16	18	
φd	0.6	0.6	0.6	0.8	0.8	0.8	0.8	
F	2.0	2.5	3.5	5.0	5.0	7.5	7.5	
φD'	φD + 0.5 max.							
L'	L + 1.5 max.					L + 2.0 max.		

◆ PART NUMBERING SYSTEM

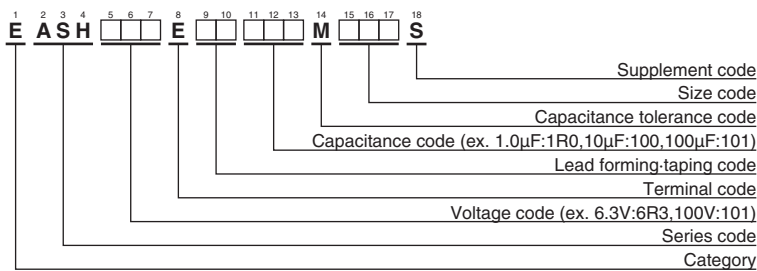

Please refer to "Product code guide (radial lead type)"

Return Group Chart



Aluminum Electrolytic Capacitors for Audio

Standard, 85°C

ASH Series

◆ STANDARD RATINGS

WV (V _{dc})	Cap (μF)	Case size φD×L(mm)	tan δ	Part No.	WV (V _{dc})	Cap (μF)	Case size φD×L(mm)	tan δ	Part No.	
6.3	330	6.3 × 11	0.26	EASH6R3E□□331MF11S	50	1.0	5 × 11	0.12	EASH500E□□1R0ME11S	
	1,000	10 × 12.5	0.26	EASH6R3E□□102MJC5S		2.2	5 × 11	0.12	EASH500E□□2R2ME11S	
	3,300	12.5 × 20	0.30	EASH6R3E□□332MK20S		3.3	5 × 11	0.12	EASH500E□□3R3ME11S	
	6,800	16 × 25	0.36	EASH6R3E□□682ML25S		4.7	5 × 11	0.12	EASH500E□□4R7ME11S	
	10,000	16 × 31.5	0.44	EASH6R3E□□103MLN3S		10	5 × 11	0.12	EASH500E□□100ME11S	
	15,000	18 × 35.5	0.54	EASH6R3E□□153MMP1S		22	5 × 11	0.12	EASH500E□□220ME11S	
10	100	5 × 11	0.22	EASH100E□□101ME11S		33	6.3 × 11	0.12	EASH500E□□330MF11S	
	220	6.3 × 11	0.22	EASH100E□□221MF11S		47	6.3 × 11	0.12	EASH500E□□470MF11S	
	470	8 × 11.5	0.22	EASH100E□□471MHB5S		100	8 × 11.5	0.12	EASH500E□□101MHB5S	
	1,000	10 × 16	0.22	EASH100E□□102MJ16S		220	10 × 16	0.12	EASH500E□□221MJ16S	
	2,200	12.5 × 20	0.24	EASH100E□□222MK20S		330	10 × 20	0.12	EASH500E□□331MJ20S	
	3,300	12.5 × 25	0.26	EASH100E□□332MK25S		470	12.5 × 20	0.12	EASH500E□□471MK20S	
	4,700	16 × 25	0.28	EASH100E□□472ML25S		1,000	16 × 25	0.12	EASH500E□□102ML25S	
	6,800	16 × 31.5	0.32	EASH100E□□682MLN3S		2,200	18 × 35.5	0.14	EASH500E□□222MMP1S	
10,000	18 × 35.5	0.40	EASH100E□□103MMP1S	63		4.7	5 × 11	0.10	EASH630E□□4R7ME11S	
16	330	8 × 11.5	0.18			EASH160E□□331MHB5S	10	5 × 11	0.10	EASH630E□□100ME11S
	470	10 × 12.5	0.18			EASH160E□□471MJC5S	22	6.3 × 11	0.10	EASH630E□□220MF11S
	1,000	10 × 20	0.18			EASH160E□□102MJ20S	33	6.3 × 11	0.10	EASH630E□□330MF11S
	2,200	12.5 × 25	0.20		EASH160E□□222MK25S	47	8 × 11.5	0.10	EASH630E□□470MHB5S	
	3,300	16 × 25	0.22		EASH160E□□332ML25S	100	10 × 12.5	0.10	EASH630E□□101MJC5S	
	4,700	16 × 31.5	0.24		EASH160E□□472MLN3S	220	10 × 20	0.10	EASH630E□□221MJ20S	
6,800	18 × 35.5	0.28	EASH160E□□682MMP1S		330	12.5 × 20	0.10	EASH630E□□331MK20S		
25	47	5 × 11	0.16		EASH250E□□470ME11S	470	12.5 × 25	0.10	EASH630E□□471MK25S	
	100	6.3 × 11	0.16		EASH250E□□101MF11S	1,000	16 × 31.5	0.10	EASH630E□□102MLN3S	
	220	8 × 11.5	0.16	EASH250E□□221MHB5S	100	1.0	5 × 11	0.10	EASH101E□□1R0ME11S	
	330	10 × 12.5	0.16	EASH250E□□331MJC5S		2.2	5 × 11	0.10	EASH101E□□2R2ME11S	
	470	10 × 16	0.16	EASH250E□□471MJ16S		3.3	5 × 11	0.10	EASH101E□□3R3ME11S	
	1,000	12.5 × 20	0.16	EASH250E□□102MK20S		4.7	5 × 11	0.10	EASH101E□□4R7ME11S	
	2,200	16 × 25	0.18	EASH250E□□222ML25S		10	6.3 × 11	0.10	EASH101E□□100MF11S	
	3,300	16 × 31.5	0.20	EASH250E□□332MLN3S		22	8 × 11.5	0.10	EASH101E□□220MHB5S	
4,700	18 × 35.5	0.22	EASH250E□□472MMP1S	33		10 × 12.5	0.10	EASH101E□□330MJC5S		
35	33	5 × 11	0.14	EASH350E□□330ME11S		47	10 × 16	0.10	EASH101E□□470MJ16S	
	220	10 × 12.5	0.14	EASH350E□□221MJC5S		100	12.5 × 20	0.10	EASH101E□□101MK20S	
	330	10 × 16	0.14	EASH350E□□331MJ16S		220	16 × 25	0.10	EASH101E□□221ML25S	
	470	10 × 20	0.14	EASH350E□□471MJ20S		330	16 × 25	0.10	EASH101E□□331ML25S	
	1,000	12.5 × 25	0.14	EASH350E□□102MK25S		470	16 × 31.5	0.10	EASH101E□□471MLN3S	
	2,200	16 × 31.5	0.16	EASH350E□□222MLN3S						
3,300	18 × 35.5	0.18	EASH350E□□332MMP1S							

□□ : Enter the appropriate lead forming or taping code.

Return Group Chart



Aluminum Electrolytic Capacitors for Audio

Standard, 85°C

AVH Series

- The oxide free copper lead wire and electrolyte on audio purpose are employed
- Non solvent resistant type
- RoHS Compliant



◆ SPECIFICATIONS

Items	Characteristics									
Category	-40 to +85°C									
Temperature Range	-40 to +85°C									
Rated Voltage Range	6.3 to 100V _{dc}									
Capacitance Tolerance	±20% (M) (at 20°C, 120Hz)									
Leakage Current	I=0.03CV or 4μA, whichever is greater. (at 20°C after 1 minute) I=0.01CV or 3μA, whichever is greater. (at 20°C after 2 minutes) Where, I : Max. leakage current (μA), C : Nominal capacitance (μF), V : Rated voltage (V)									
Dissipation Factor (tan δ)	Rated voltage (V _{dc})	6.3V	10V	16V	25V	35V	50V	63V	80V	100V
	tan δ (Max.)	0.24	0.20	0.16	0.14	0.12	0.10	0.09	0.08	0.07
	When nominal capacitance exceeds 1,000μF, add 0.02 to the value above for each 1,000μF increase. (at 20°C, 120Hz)									
Low Temperature Characteristics (Max. Impedance Ratio)	Rated voltage (V _{dc})	6.3V	10V	16V	25V	35V	50V	63V	80V	100V
	Z(-25°C)/Z(+20°C)	4	3	2	2	2	2	2	2	2
	Z(-40°C)/Z(+20°C)	10	8	6	4	3	3	3	3	3
(at 120Hz)										
Endurance	The following specifications shall be satisfied when the capacitors are restored to 20°C after the rated voltage is applied for 1,000 hours at 85°C.									
	Capacitance change	≤ ±20% of the initial value								
	D.F. (tan δ)	≤ 150% of the initial specified value								
	Leakage current	≤ The initial specified value								
Shelf Life	The following specifications shall be satisfied when the capacitors are restored to 20°C after exposing them for 500 hours at 85°C without voltage applied. Before the measurement, the capacitor shall be preconditioned by applying voltage according to Item 4.1 of JIS C 5101-4.									
	Capacitance change	≤ ±20% of the initial value								
	D.F. (tan δ)	≤ 150% of the initial specified value								
	Leakage current	≤ The initial specified value								

◆ DIMENSIONS [mm]

- Terminal Code : E

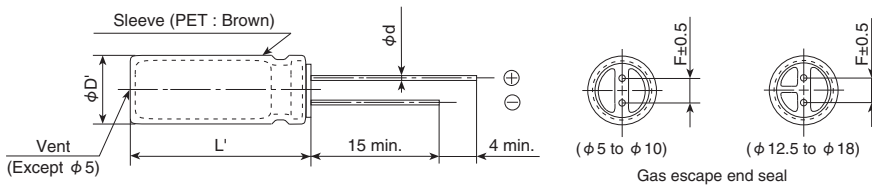

φ D	5	6.3	8	10	12.5	16	18
φ d	0.6	0.6	0.6	0.8	0.8	0.8	0.8
F	2.0	2.5	3.5	5.0	5.0	7.5	7.5
φ D'	φ D + 0.5 max.						
L'	L + 1.5 max.					L + 2.0 max.	

◆ PART NUMBERING SYSTEM

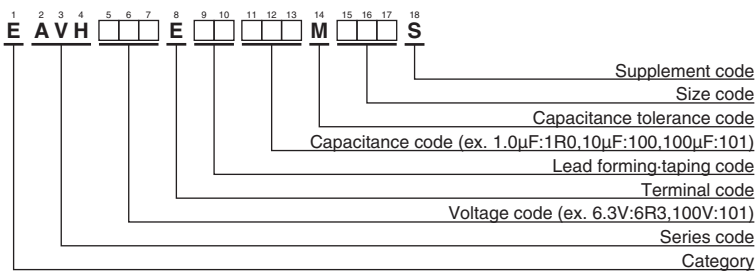

Please refer to "Product code guide (radial lead type)"

Return Group Chart



Aluminum Electrolytic Capacitors for Audio

Standard, 85°C

AVH Series

◆STANDARD RATINGS

WV (V _{dc})	Cap (μF)	Case size φD×L(mm)	tan δ	Part No.	WV (V _{dc})	Cap (μF)	Case size φD×L(mm)	tan δ	Part No.
6.3	470	10 × 12.5	0.24	EAVH6R3E□□471MJC5S	50	1.0	5 × 11	0.10	EAVH500E□□1R0ME11S
	1,000	10 × 20	0.24	EAVH6R3E□□102MJ20S		2.2	5 × 11	0.10	EAVH500E□□2R2ME11S
	2,200	12.5 × 25	0.26	EAVH6R3E□□222MK25S		3.3	5 × 11	0.10	EAVH500E□□3R3ME11S
	3,300	16 × 25	0.28	EAVH6R3E□□332ML25S		4.7	5 × 11	0.10	EAVH500E□□4R7ME11S
	4,700	16 × 31.5	0.30	EAVH6R3E□□472MLN3S		10	5 × 11	0.10	EAVH500E□□100ME11S
	6,800	16 × 35.5	0.34	EAVH6R3E□□682MLP1S		22	6.3 × 11	0.10	EAVH500E□□220MF11S
	10,000	18 × 40	0.42	EAVH6R3E□□103MM40S		33	8 × 11.5	0.10	EAVH500E□□330MHB5S
10	47	5 × 11	0.20	EAVH100E□□470ME11S		47	8 × 11.5	0.10	EAVH500E□□470MHB5S
	100	6.3 × 11	0.20	EAVH100E□□101MF11S		100	10 × 16	0.10	EAVH500E□□101MJ16S
	220	8 × 11.5	0.20	EAVH100E□□221MHB5S		220	12.5 × 20	0.10	EAVH500E□□221MK20S
	330	10 × 12.5	0.20	EAVH100E□□331MJC5S		330	12.5 × 20	0.10	EAVH500E□□331MK20S
	470	10 × 16	0.20	EAVH100E□□471MJ16S		470	16 × 25	0.10	EAVH500E□□471ML25S
	1,000	12.5 × 20	0.20	EAVH100E□□102MK20S		1,000	16 × 31.5	0.10	EAVH500E□□102MLN3S
	2,200	16 × 25	0.22	EAVH100E□□222ML25S		63	2.2	5 × 11	0.09
	3,300	16 × 31.5	0.24	EAVH100E□□332MLN3S	3.3		5 × 11	0.09	EAVH630E□□3R3ME11S
	4,700	16 × 35.5	0.26	EAVH100E□□472MLP1S	4.7		5 × 11	0.09	EAVH630E□□4R7ME11S
6,800	18 × 40	0.30	EAVH100E□□682MM40S	10	6.3 × 11		0.09	EAVH630E□□100MF11S	
16	33	5 × 11	0.16	EAVH160E□□330ME11S	22		8 × 11.5	0.09	EAVH630E□□220MHB5S
	100	8 × 11.5	0.16	EAVH160E□□101MHB5S	33		8 × 11.5	0.09	EAVH630E□□330MHB5S
	220	10 × 12.5	0.16	EAVH160E□□221MJC5S	47		10 × 12.5	0.09	EAVH630E□□470MJC5S
	330	10 × 16	0.16	EAVH160E□□331MJ16S	100		10 × 20	0.09	EAVH630E□□101MJ20S
	470	10 × 20	0.16	EAVH160E□□471MJ20S	220		12.5 × 20	0.09	EAVH630E□□221MK20S
	1,000	12.5 × 25	0.16	EAVH160E□□102MK25S	330		12.5 × 25	0.09	EAVH630E□□331MK25S
	2,200	16 × 25	0.18	EAVH160E□□222ML25S	470	16 × 25	0.09	EAVH630E□□471ML25S	
	3,300	16 × 35.5	0.20	EAVH160E□□332MLP1S	1,000	18 × 35.5	0.09	EAVH630E□□102MMP1S	
	4,700	18 × 35.5	0.22	EAVH160E□□472MMP1S	80	47	10 × 16	0.08	EAVH800E□□470MJ16S
25	22	5 × 11	0.14	EAVH250E□□220ME11S		220	12.5 × 25	0.08	EAVH800E□□221MK25S
	47	6.3 × 11	0.14	EAVH250E□□470MF11S		330	16 × 31.5	0.08	EAVH800E□□331MLN3S
	100	8 × 11.5	0.14	EAVH250E□□101MHB5S		470	16 × 35.5	0.08	EAVH800E□□471MLP1S
	220	10 × 16	0.14	EAVH250E□□221MJ16S	100	1.0	5 × 11	0.07	EAVH101E□□1R0ME11S
	330	10 × 20	0.14	EAVH250E□□331MJ20S		2.2	5 × 11	0.07	EAVH101E□□2R2ME11S
	470	12.5 × 20	0.14	EAVH250E□□471MK20S		3.3	5 × 11	0.07	EAVH101E□□3R3ME11S
	1,000	16 × 25	0.14	EAVH250E□□102ML25S		4.7	6.3 × 11	0.07	EAVH101E□□4R7MF11S
	2,200	16 × 35.5	0.16	EAVH250E□□222MLP1S		10	8 × 11.5	0.07	EAVH101E□□100MHB5S
	3,300	18 × 40	0.18	EAVH250E□□332MM40S		22	10 × 12.5	0.07	EAVH101E□□220MJC5S
35	33	6.3 × 11	0.12	EAVH350E□□330MF11S		33	10 × 16	0.07	EAVH101E□□330MJ16S
	100	10 × 12.5	0.12	EAVH350E□□101MJC5S		47	10 × 20	0.07	EAVH101E□□470MJ20S
	220	10 × 20	0.12	EAVH350E□□221MJ20S		100	12.5 × 20	0.07	EAVH101E□□101MK20S
	470	12.5 × 25	0.12	EAVH350E□□471MK25S		220	16 × 25	0.07	EAVH101E□□221ML25S
	1,000	16 × 25	0.12	EAVH350E□□102ML25S		330	16 × 31.5	0.07	EAVH101E□□331MLN3S
	2,200	18 × 35.5	0.14	EAVH350E□□222MMP1S		470	18 × 35.5	0.07	EAVH101E□□471MMP1S

□□ : Enter the appropriate lead forming or taping code.

Return Group Chart



Aluminum Electrolytic Capacitors for Audio

High grade, 85°C

AWJ Series

- Please consult with us when you need "Bi-polar" type
- Non solvent resistant type
- RoHS Compliant



◆ SPECIFICATIONS

Items	Characteristics
Category	-40 to +85°C
Temperature Range	-40 to +85°C
Rated Voltage Range	16 to 100V _{dc}
Capacitance Tolerance	±20% (M) (at 20°C, 120Hz)
Leakage Current	I = 0.01CV or 3μA, whichever is greater. Where, I : Max. leakage current (μA), C : Nominal capacitance (μF), V : Rated voltage (V) (at 20°C after 2 minutes)
Dissipation Factor (tan δ)	Rated voltage (V _{dc})
	tan δ (Max.)
Low Temperature Characteristics (Max. Impedance Ratio)	Rated voltage (V _{dc})
	Z(-25°C)/Z(+20°C)
	Z(-40°C)/Z(+20°C)
Endurance	The following specifications shall be satisfied when the capacitors are restored to 20°C after the rated voltage is applied for 1,000 hours at 85°C.
Shelf Life	The following specifications shall be satisfied when the capacitors are restored to 20°C after exposing them for 500 hours at 85°C without voltage applied. Before the measurement, the capacitor shall be preconditioned by applying voltage according to Item 4.1 of JIS C 5101-4.
	Capacitance change
	D.F. (tan δ)
	Leakage current

◆ DIMENSIONS [mm]

- Terminal Code : E

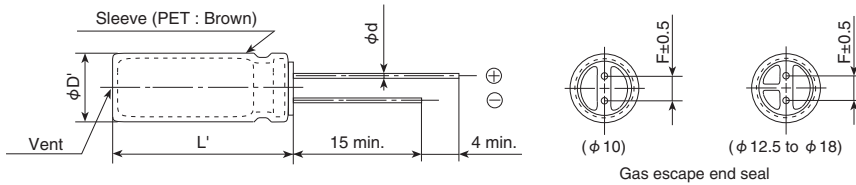

φD	10	12.5	16	18
φd	0.8	0.8	0.8	0.8
F	5.0		7.5	
φD'	φD + 0.5 max.			
L'	L + 1.5 max.		L + 2.0 max.	

◆ PART NUMBERING SYSTEM

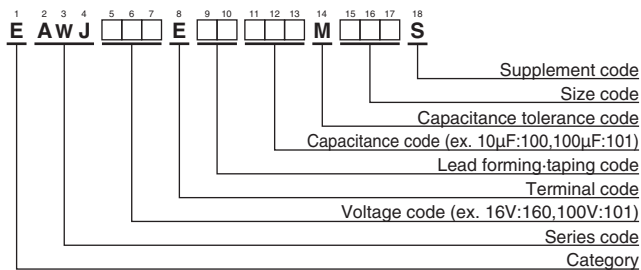

Please refer to "Product code guide (radial lead type)"

Return Group Chart



Aluminum Electrolytic Capacitors for Audio

High grade, 85°C

AWJ Series

◆STANDARD RATINGS

WV (V _{dc})	Cap (μF)	Case size φD×L(mm)	tan δ	Part No.	WV (V _{dc})	Cap (μF)	Case size φD×L(mm)	tan δ	Part No.
16	220	10 × 20	0.16	EAWJ160E□□221MJ20S	80	22	10 × 16	0.08	EAWJ800E□□220MJ16S
	330	12.5 × 20	0.16	EAWJ160E□□331MK20S		33	10 × 20	0.08	EAWJ800E□□330MJ20S
	470	12.5 × 25	0.16	EAWJ160E□□471MK25S		47	10 × 20	0.08	EAWJ800E□□470MJ20S
	1,000	16 × 31.5	0.16	EAWJ160E□□102MLN3S		100	12.5 × 25	0.08	EAWJ800E□□101MK25S
25	100	10 × 16	0.14	EAWJ250E□□101MJ16S		220	16 × 31.5	0.08	EAWJ800E□□221MLN3S
	220	12.5 × 20	0.14	EAWJ250E□□221MK20S		330	16 × 35.5	0.08	EAWJ800E□□331MLP1S
	330	12.5 × 25	0.14	EAWJ250E□□331MK25S		470	18 × 40	0.08	EAWJ800E□□471MM40S
	470	16 × 25	0.14	EAWJ250E□□471ML25S		100	10	10 × 16	0.07
	1,000	16 × 35.5	0.14	EAWJ250E□□102MLP1S	22		10 × 20	0.07	EAWJ101E□□220MJ20S
50	22	10 × 16	0.10	EAWJ500E□□220MJ16S	33		12.5 × 20	0.07	EAWJ101E□□330MK20S
	33	10 × 16	0.10	EAWJ500E□□330MJ16S	47		12.5 × 25	0.07	EAWJ101E□□470MK25S
	47	10 × 16	0.10	EAWJ500E□□470MJ16S	100		16 × 25	0.07	EAWJ101E□□101ML25S
	100	12.5 × 20	0.10	EAWJ500E□□101MK20S	220		18 × 35.5	0.07	EAWJ101E□□221MMP1S
	220	16 × 25	0.10	EAWJ500E□□221ML25S	330		18 × 45	0.07	EAWJ101E□□331MM45S
	330	16 × 31.5	0.10	EAWJ500E□□331MLN3S					
	470	16 × 35.5	0.10	EAWJ500E□□471MLP1S					
1,000	18 × 45	0.10	EAWJ500E□□102MM45S						

□□ : Enter the appropriate lead forming or taping code.

Return Group Chart



Aluminum Electrolytic Capacitors for Audio

For Speaker Network, 85°C

SNX-BP Series

- Standard product for the speaker network which downsized conventional products
- Suitable for high-output speaker network
- Nominal capacitance range : 1 to 56μF, Rated voltage range : 63V
- Non solvent resistant type
- RoHS Compliant



SPECIFICATIONS

Items	Characteristics						
Category Temperature Range	-40 to +85°C						
Rated Voltage Range	63V _{ac}						
Rated Capacitance Range	1.0 to 56μF (at 20°C, 1kHz)						
Capacitance Tolerance	± 10% (K) (at 20°C, 1kHz)						
Leakage Current	I=0.01CV or 3μA, whichever is greater. Where, I : Max. leakage current (μA), C : Nominal capacitance (μF), V : Rated voltage (V) (at 20°C after 2 minutes)						
Dissipation Factor (tan δ)	0.11 max. (at 20°C, 1kHz)						
Low Temperature Characteristics (Max. Impedance Ratio)	Z(-25°C)/Z(+20°C) ≤ 2 Z(-40°C)/Z(+20°C) ≤ 4 (at 120Hz)						
Endurance	The following specifications shall be satisfied when the capacitors are restored to 20°C after the rated voltage is applied for 1,000 hours at 85°C, however the polarization shall be reversed every 250 hours. <table border="1"> <tr> <td>Capacitance change</td> <td>≤ ± 15% of the initial value</td> </tr> <tr> <td>D.F. (tan δ)</td> <td>≤ 150% of the initial specified value</td> </tr> <tr> <td>Leakage current</td> <td>≤ The initial specified value (at 20°C, 1kHz)</td> </tr> </table>	Capacitance change	≤ ± 15% of the initial value	D.F. (tan δ)	≤ 150% of the initial specified value	Leakage current	≤ The initial specified value (at 20°C, 1kHz)
Capacitance change	≤ ± 15% of the initial value						
D.F. (tan δ)	≤ 150% of the initial specified value						
Leakage current	≤ The initial specified value (at 20°C, 1kHz)						
Shelf Life	The following specifications shall be satisfied when the capacitors are restored to 20°C after exposing them for 500 hours at 85°C without voltage applied. Before the measurement, the capacitor shall be preconditioned by applying voltage according to Item 4.1 of JIS C 5101-4. <table border="1"> <tr> <td>Capacitance change</td> <td>≤ ± 15% of the initial value</td> </tr> <tr> <td>D.F. (tan δ)</td> <td>≤ 150% of the initial specified value</td> </tr> <tr> <td>Leakage current</td> <td>≤ The initial specified value (at 20°C, 1kHz)</td> </tr> </table>	Capacitance change	≤ ± 15% of the initial value	D.F. (tan δ)	≤ 150% of the initial specified value	Leakage current	≤ The initial specified value (at 20°C, 1kHz)
Capacitance change	≤ ± 15% of the initial value						
D.F. (tan δ)	≤ 150% of the initial specified value						
Leakage current	≤ The initial specified value (at 20°C, 1kHz)						

DIMENSIONS[mm]

- Terminal Code : E

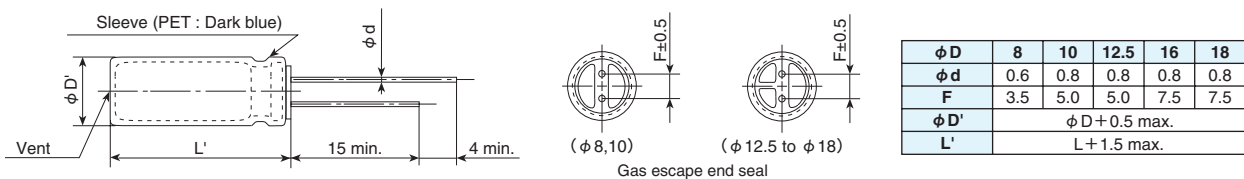

PART NUMBERING SYSTEM

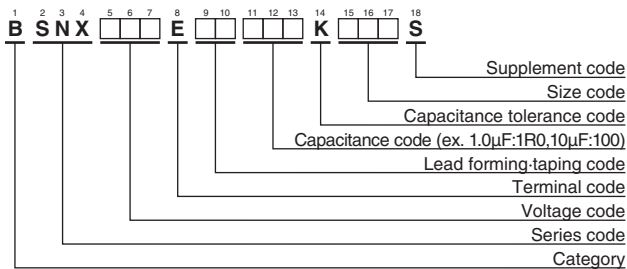

Please refer to "Product code guide (radial lead type)"

STANDARD RATINGS

WV (V _{ac})	Cap (μF)	Case size φD×L(mm)	tan δ	Rated ripple current (mArms/85°C, 1kHz)	Part No.	WV (V _{ac})	Cap (μF)	Case size φD×L(mm)	tan δ	Rated ripple current (mArms/85°C, 1kHz)	Part No.
63	1.0	8 × 11.5	0.11	44	BSNX630E□□1R0KHB5S	63	8.2	12.5 × 20	0.11	197	BSNX630E□□8R2KK20S
	1.2	8 × 11.5	0.11	48	BSNX630E□□1R2KHB5S		10	12.5 × 25	0.11	236	BSNX630E□□100KK25S
	1.5	8 × 11.5	0.11	54	BSNX630E□□1R5KHB5S		12	12.5 × 25	0.11	259	BSNX630E□□120KK25S
	1.8	8 × 11.5	0.11	59	BSNX630E□□1R8KHB5S		15	12.5 × 25	0.11	290	BSNX630E□□150KK25S
	2.2	8 × 11.5	0.11	65	BSNX630E□□2R2KHB5S		18	16 × 25	0.11	351	BSNX630E□□180KL25S
	2.7	8 × 11.5	0.11	72	BSNX630E□□2R7KHB5S		22	16 × 25	0.11	388	BSNX630E□□220KL25S
	3.3	10 × 16	0.11	104	BSNX630E□□3R3KJ16S		27	16 × 35.5	0.11	474	BSNX630E□□270KLP1S
	3.9	10 × 16	0.11	113	BSNX630E□□3R9KJ16S		33	16 × 35.5	0.11	524	BSNX630E□□330KLP1S
	4.7	10 × 16	0.11	124	BSNX630E□□4R7KJ16S		39	18 × 35.5	0.11	594	BSNX630E□□390KMP1S
	5.6	10 × 20	0.11	146	BSNX630E□□5R6KJ20S		47	18 × 35.5	0.11	652	BSNX630E□□470KMP1S
6.8	10 × 20	0.11	161	BSNX630E□□6R8KJ20S	56	18 × 40	0.11	723	BSNX630E□□560KM40S		

□□ : Enter the appropriate lead forming or taping code.

Product specifications in this catalog are subject to change without notice. Request our product specifications before purchase and/or use. Please use our products based on the information contained in this catalog and product specifications.



AJ Series



- The high-quality sound design that realized relaxed rich representation
- Suitable for AV receiver/Amplifier for the home theater use.
- Non solvent resistant type
- RoHS Compliant

◆ SPECIFICATIONS

Items	Characteristics			
Category	-40 to +85°C			
Temperature Range	-40 to +85°C			
Rated Voltage Range	25 to 125V _{dc}			
Capacitance Tolerance	±20% (M) (at 20°C, 120Hz)			
Leakage Current	I=0.02CV or 3mA, whichever is smaller. Where, I : Max. leakage current (μA), C : Nominal capacitance (μF), V : Rated voltage (V) (at 20°C after 5 minutes)			
Dissipation Factor (tan δ)	Rated voltage (V _{dc})	25V	35 to 63V	71 to 125V
	tan δ (Max.)	0.35	0.30	0.25
Low Temperature Characteristics (Max. Impedance Ratio)	Rated voltage (V _{dc})	25V	35 to 63V	71 to 125V
	Z(-25°C)/Z(+20°C)	4	3	4
	Z(-40°C)/Z(+20°C)	15	10	15
		(at 120Hz)		
Endurance	The following specifications shall be satisfied when the capacitors are restored to 20°C after the rated voltage is applied for 1,000 hours at 85°C.			
	Capacitance change	≤ ±20% of the initial value		
	D.F. (tan δ)	≤ 200% of the initial specified value		
	Leakage current	≤ The initial specified value		
Shelf Life	The following specifications shall be satisfied when the capacitors are restored to 20°C after exposing them for 500 hours at 85°C without voltage applied. Before the measurement, the capacitor shall be preconditioned by applying voltage according to Item 4.1 of JIS C 5101-4.			
	Capacitance change	≤ ±20% of the initial value		
	D.F. (tan δ)	≤ 200% of the initial specified value		
	Leakage current	≤ The initial specified value		

◆ DIMENSIONS[mm]

● Terminal Code : VS (φ 22 to φ 35) : Standard

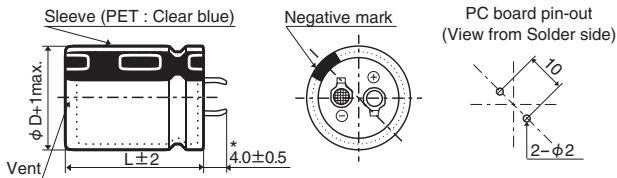

● Terminal Code : LI (φ 35)

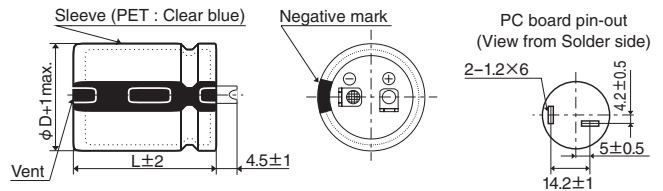

* φD=35mm : 3.5±0.5mm

The standard design has no plastic disc.

◆ PART NUMBERING SYSTEM

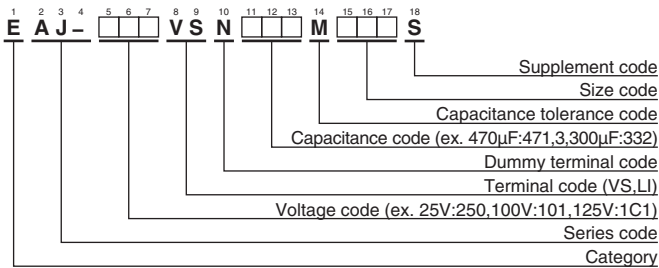

Please refer to "Product code guide (snap-in type)"

Return Group Chart



Aluminum Electrolytic Capacitors for Audio

Snap-ins, 85°C

AJ Series

◆ **STANDARD RATINGS**

WV (V _{dc})	Cap (μF)	Case size φD×L(mm)	tan δ	Part No.	WV (V _{dc})	Cap (μF)	Case size φD×L(mm)	tan δ	Part No.
25	3,300	22 × 25	0.35	EAJ-250VSN332MP25S	42	4,700	22 × 45	0.30	EAJ-420VSN472MP45S
	3,900	22 × 25	0.35	EAJ-250VSN392MP25S		4,700	25.4 × 35	0.30	EAJ-420VSN472MQ35S
	4,700	22 × 30	0.35	EAJ-250VSN472MP30S		4,700	30 × 30	0.30	EAJ-420VSN472MR30S
	5,600	22 × 30	0.35	EAJ-250VSN562MP30S		4,700	35 × 25	0.30	EAJ-420VSN472MA25S
	6,800	22 × 35	0.35	EAJ-250VSN682MP35S		5,600	22 × 50	0.30	EAJ-420VSN562MP50S
	6,800	25.4 × 30	0.35	EAJ-250VSN682MQ30S		5,600	25.4 × 40	0.30	EAJ-420VSN562MQ40S
	6,800	30 × 25	0.35	EAJ-250VSN682MP25S		5,600	30 × 35	0.30	EAJ-420VSN562MR35S
	8,200	22 × 40	0.35	EAJ-250VSN822MP40S		5,600	35 × 25	0.30	EAJ-420VSN562MA25S
	8,200	25.4 × 35	0.35	EAJ-250VSN822MQ35S		6,800	25.4 × 50	0.30	EAJ-420VSN682MQ50S
	8,200	30 × 30	0.35	EAJ-250VSN822MR30S		6,800	30 × 40	0.30	EAJ-420VSN682MR40S
	10,000	22 × 45	0.35	EAJ-250VSN103MP45S		6,800	35 × 30	0.30	EAJ-420VSN682MA30S
	10,000	25.4 × 40	0.35	EAJ-250VSN103MQ40S		8,200	25.4 × 60	0.30	EAJ-420VSN822MQ60S
	10,000	30 × 30	0.35	EAJ-250VSN103MR30S		8,200	30 × 45	0.30	EAJ-420VSN822MP45S
	10,000	35 × 25	0.35	EAJ-250VSN103MA25S		8,200	35 × 35	0.30	EAJ-420VSN822MA35S
	12,000	22 × 50	0.35	EAJ-250VSN123MP50S		10,000	30 × 50	0.30	EAJ-420VSN103MA50S
	12,000	25.4 × 45	0.35	EAJ-250VSN123MQ45S		10,000	35 × 40	0.30	EAJ-420VSN103MA40S
	12,000	30 × 35	0.35	EAJ-250VSN123MR35S		12,000	30 × 50	0.30	EAJ-420VSN123MP50S
	12,000	35 × 30	0.35	EAJ-250VSN123MA30S		12,000	35 × 45	0.30	EAJ-420VSN123MA45S
	15,000	25.4 × 50	0.35	EAJ-250VSN153MQ50S		15,000	35 × 50	0.30	EAJ-420VSN153MA50S
	15,000	30 × 40	0.35	EAJ-250VSN153MR40S		18,000	35 × 60	0.30	EAJ-420VSN183MA60S
15,000	35 × 35	0.35	EAJ-250VSN153MA35S	56	1,000	22 × 25	0.30	EAJ-560VSN102MP25S	
18,000	25.4 × 60	0.35	EAJ-250VSN183MQ60S		1,200	22 × 30	0.30	EAJ-560VSN122MP30S	
18,000	30 × 45	0.35	EAJ-250VSN183MR45S		1,500	22 × 30	0.30	EAJ-560VSN152MP30S	
18,000	35 × 35	0.35	EAJ-250VSN183MA35S		1,800	22 × 35	0.30	EAJ-560VSN182MP35S	
22,000	30 × 50	0.35	EAJ-250VSN223MR50S		2,200	22 × 35	0.30	EAJ-560VSN222MP35S	
22,000	35 × 40	0.35	EAJ-250VSN223MA40S		2,200	25.4 × 30	0.30	EAJ-560VSN222MQ30S	
27,000	30 × 55	0.35	EAJ-250VSN273MR55S		2,700	22 × 40	0.30	EAJ-560VSN272MP40S	
27,000	35 × 50	0.35	EAJ-250VSN273MA50S		2,700	25.4 × 35	0.30	EAJ-560VSN272MQ35S	
33,000	35 × 55	0.35	EAJ-250VSN333MA55S		3,300	22 × 45	0.30	EAJ-560VSN332MP45S	
39,000	35 × 60	0.35	EAJ-250VSN393MA60S		3,300	25.4 × 40	0.30	EAJ-560VSN332MQ40S	
35	2,200	22 × 25	0.30		EAJ-350VSN222MP25S	3,300	30 × 30	0.30	EAJ-560VSN332MR30S
	2,700	22 × 25	0.30		EAJ-350VSN272MP25S	3,900	22 × 50	0.30	EAJ-560VSN392MP50S
	3,300	22 × 30	0.30		EAJ-350VSN332MP30S	3,900	25.4 × 40	0.30	EAJ-560VSN392MQ40S
	3,300	25.4 × 25	0.30		EAJ-350VSN332MQ25S	3,900	30 × 35	0.30	EAJ-560VSN392MR35S
	3,900	22 × 35	0.30		EAJ-350VSN392MP35S	3,900	35 × 30	0.30	EAJ-560VSN392MA30S
	3,900	25.4 × 25	0.30		EAJ-350VSN392MQ25S	4,700	25.4 × 45	0.30	EAJ-560VSN472MQ45S
	4,700	22 × 35	0.30		EAJ-350VSN472MP35S	4,700	30 × 40	0.30	EAJ-560VSN472MR40S
	4,700	25.4 × 30	0.30		EAJ-350VSN472MQ30S	4,700	35 × 30	0.30	EAJ-560VSN472MA30S
	5,600	22 × 40	0.30		EAJ-350VSN562MP40S	5,600	25.4 × 55	0.30	EAJ-560VSN562MQ55S
	5,600	25.4 × 35	0.30		EAJ-350VSN562MP35S	5,600	30 × 45	0.30	EAJ-560VSN562MR45S
	5,600	30 × 30	0.30	EAJ-350VSN562MR30S	5,600	35 × 35	0.30	EAJ-560VSN562MA35S	
	6,800	22 × 45	0.30	EAJ-350VSN682MP45S	6,800	25.4 × 60	0.30	EAJ-560VSN682MQ60S	
	6,800	25.4 × 40	0.30	EAJ-350VSN682MQ40S	6,800	30 × 50	0.30	EAJ-560VSN682MR50S	
	6,800	30 × 30	0.30	EAJ-350VSN682MR30S	6,800	35 × 40	0.30	EAJ-560VSN682MA40S	
	8,200	25.4 × 45	0.30	EAJ-350VSN822MQ45S	8,200	30 × 55	0.30	EAJ-560VSN822MR55S	
	8,200	30 × 35	0.30	EAJ-350VSN822MR35S	8,200	35 × 45	0.30	EAJ-560VSN822MA45S	
	8,200	35 × 30	0.30	EAJ-350VSN822MA30S	10,000	30 × 60	0.30	EAJ-560VSN103MR60S	
	10,000	25.4 × 50	0.30	EAJ-350VSN103MQ50S	10,000	35 × 50	0.30	EAJ-560VSN103MA50S	
	10,000	30 × 40	0.30	EAJ-350VSN103MR40S	12,000	30 × 60	0.30	EAJ-560VSN123MR60S	
	10,000	35 × 35	0.30	EAJ-350VSN103MA35S	12,000	35 × 55	0.30	EAJ-560VSN123MA55S	
12,000	25.4 × 55	0.30	EAJ-350VSN123MQ55S	15,000	35 × 60	0.30	EAJ-560VSN153MA60S		
12,000	30 × 45	0.30	EAJ-350VSN123MR45S	63	1,000	22 × 25	0.30	EAJ-630VSN102MP25S	
12,000	35 × 35	0.30	EAJ-350VSN123MA35S		1,200	22 × 30	0.30	EAJ-630VSN122MP30S	
15,000	30 × 50	0.30	EAJ-350VSN153MR50S		1,500	22 × 30	0.30	EAJ-630VSN152MP30S	
15,000	35 × 40	0.30	EAJ-350VSN153MA40S		1,800	22 × 35	0.30	EAJ-630VSN182MP35S	
18,000	30 × 55	0.30	EAJ-350VSN183MR55S		1,800	25.4 × 30	0.30	EAJ-630VSN182MQ30S	
18,000	35 × 45	0.30	EAJ-350VSN183MA45S		2,200	22 × 40	0.30	EAJ-630VSN222MP40S	
22,000	35 × 55	0.30	EAJ-350VSN223MA55S		2,200	25.4 × 35	0.30	EAJ-630VSN222MQ35S	
42	1,800	22 × 25	0.30		EAJ-420VSN182MP25S	2,200	30 × 30	0.30	EAJ-630VSN222MR30S
	2,200	22 × 25	0.30		EAJ-420VSN222MP25S	2,700	22 × 45	0.30	EAJ-630VSN272MP45S
	2,700	22 × 30	0.30		EAJ-420VSN272MP30S	2,700	25.4 × 40	0.30	EAJ-630VSN272MQ40S
	2,700	25.4 × 25	0.30		EAJ-420VSN272MQ25S	2,700	30 × 30	0.30	EAJ-630VSN272MR30S
	3,300	22 × 35	0.30		EAJ-420VSN332MP35S	3,300	25.4 × 45	0.30	EAJ-630VSN332MQ45S
	3,300	25.4 × 30	0.30		EAJ-420VSN332MQ30S	3,300	30 × 35	0.30	EAJ-630VSN332MR35S
	3,900	22 × 40	0.30		EAJ-420VSN392MP40S	3,300	35 × 30	0.30	EAJ-630VSN332MA30S
	3,900	25.4 × 30	0.30		EAJ-420VSN392MQ30S	3,900	25.4 × 50	0.30	EAJ-630VSN392MQ50S
	3,900	30 × 25	0.30		EAJ-420VSN392MR25S	3,900	30 × 40	0.30	EAJ-630VSN392MR40S

Product specifications in this catalog are subject to change without notice. Request our product specifications before purchase and/or use. Please use our products based on the information contained in this catalog and product specifications.

Return Group Chart



Aluminum Electrolytic Capacitors for Audio

Snap-ins, 85°C

AJ Series

◆STANDARD RATINGS

WV (V _{dc})	Cap (μF)	Case size φD×L(mm)	tan δ	Part No.	WV (V _{dc})	Cap (μF)	Case size φD×L(mm)	tan δ	Part No.
63	3,900	35 × 30	0.30	EAJ-630VSN392MA30S	80	3,300	25.4 × 55	0.25	EAJ-800VSN332MQ55S
	4,700	25.4 × 55	0.30	EAJ-630VSN472MQ55S		3,300	30 × 45	0.25	EAJ-800VSN332MR45S
	4,700	30 × 45	0.30	EAJ-630VSN472MR45S		3,300	35 × 35	0.25	EAJ-800VSN332MA35S
	4,700	35 × 35	0.30	EAJ-630VSN472MA35S		3,900	25.4 × 55	0.25	EAJ-800VSN392MQ55S
	5,600	25.4 × 60	0.30	EAJ-630VSN562MQ60S		3,900	30 × 50	0.25	EAJ-800VSN392MR50S
	5,600	30 × 50	0.30	EAJ-630VSN562MR50S		3,900	35 × 40	0.25	EAJ-800VSN392MA40S
	5,600	35 × 40	0.30	EAJ-630VSN562MA40S		4,700	30 × 55	0.25	EAJ-800VSN472MR55S
	6,800	25.4 × 60	0.30	EAJ-630VSN682MQ60S		4,700	35 × 45	0.25	EAJ-800VSN472MA45S
	6,800	30 × 55	0.30	EAJ-630VSN682MR55S		5,600	30 × 60	0.25	EAJ-800VSN562MR60S
	6,800	35 × 45	0.30	EAJ-630VSN682MA45S		5,600	35 × 50	0.25	EAJ-800VSN562MA50S
	8,200	30 × 60	0.30	EAJ-630VSN822MR60S		6,800	35 × 55	0.25	EAJ-800VSN682MA55S
	8,200	35 × 50	0.30	EAJ-630VSN822MA50S		8,200	35 × 60	0.25	EAJ-800VSN822MA60S
71	1,000	22 × 30	0.25	EAJ-710VSN102MP30S	100	470	22 × 25	0.25	EAJ-101VSN471MP25S
	1,200	22 × 30	0.25	EAJ-710VSN122MP30S		560	22 × 30	0.25	EAJ-101VSN561MP30S
	1,500	22 × 35	0.25	EAJ-710VSN152MP35S		820	22 × 35	0.25	EAJ-101VSN821MP35S
	1,500	25.4 × 30	0.25	EAJ-710VSN152MQ30S		820	25.4 × 30	0.25	EAJ-101VSN821MQ30S
	1,800	22 × 40	0.25	EAJ-710VSN182MP40S		1,000	22 × 40	0.25	EAJ-101VSN102MP40S
	1,800	25.4 × 35	0.25	EAJ-710VSN182MQ35S		1,000	25.4 × 35	0.25	EAJ-101VSN102MQ35S
	1,800	30 × 30	0.25	EAJ-710VSN182MR30S		1,200	22 × 45	0.25	EAJ-101VSN122MP45S
	2,200	22 × 45	0.25	EAJ-710VSN222MP45S		1,200	25.4 × 40	0.25	EAJ-101VSN122MQ40S
	2,200	25.4 × 40	0.25	EAJ-710VSN222MQ40S		1,200	30 × 30	0.25	EAJ-101VSN122MR30S
	2,200	30 × 30	0.25	EAJ-710VSN222MR30S		1,500	22 × 50	0.25	EAJ-101VSN152MP50S
	2,700	25.4 × 45	0.25	EAJ-710VSN272MQ45S		1,500	25.4 × 45	0.25	EAJ-101VSN152MQ45S
	2,700	30 × 35	0.25	EAJ-710VSN272MR35S		1,500	30 × 35	0.25	EAJ-101VSN152MR35S
80	2,700	35 × 30	0.25	EAJ-710VSN272MA30S	1,500	35 × 30	0.25	EAJ-101VSN152MA30S	
	3,300	25.4 × 50	0.25	EAJ-710VSN332MQ50S	1,800	25.4 × 50	0.25	EAJ-101VSN182MQ50S	
	3,300	30 × 40	0.25	EAJ-710VSN332MR40S	1,800	30 × 40	0.25	EAJ-101VSN182MR40S	
	3,300	35 × 30	0.25	EAJ-710VSN332MA30S	1,800	35 × 30	0.25	EAJ-101VSN182MA30S	
	3,900	25.4 × 55	0.25	EAJ-710VSN392MQ55S	2,200	25.4 × 55	0.25	EAJ-101VSN222MQ55S	
	3,900	30 × 45	0.25	EAJ-710VSN392MR45S	2,200	30 × 45	0.25	EAJ-101VSN222MR45S	
	3,900	35 × 35	0.25	EAJ-710VSN392MA35S	2,200	35 × 35	0.25	EAJ-101VSN222MA35S	
	4,700	25.4 × 60	0.25	EAJ-710VSN472MQ60S	2,700	25.4 × 60	0.25	EAJ-101VSN272MQ60S	
	4,700	30 × 50	0.25	EAJ-710VSN472MR50S	2,700	30 × 50	0.25	EAJ-101VSN272MR50S	
	4,700	35 × 40	0.25	EAJ-710VSN472MA40S	2,700	35 × 40	0.25	EAJ-101VSN272MA40S	
	5,600	25.4 × 60	0.25	EAJ-710VSN562MQ60S	3,300	30 × 55	0.25	EAJ-101VSN332MR55S	
	5,600	30 × 55	0.25	EAJ-710VSN562MR55S	3,300	35 × 45	0.25	EAJ-101VSN332MA45S	
5,600	35 × 45	0.25	EAJ-710VSN562MA45S	3,900	35 × 50	0.25	EAJ-101VSN392MA50S		
6,800	30 × 60	0.25	EAJ-710VSN682MR60S	4,700	35 × 55	0.25	EAJ-101VSN472MA55S		
6,800	35 × 50	0.25	EAJ-710VSN682MA50S	5,600	35 × 60	0.25	EAJ-101VSN562MA60S		
8,200	35 × 55	0.25	EAJ-710VSN822MA55S	125	470	22 × 30	0.25	EAJ-1C1VSN471MP30S	
10,000	35 × 60	0.25	EAJ-710VSN103MA60S		560	22 × 35	0.25	EAJ-1C1VSN561MP35S	
820	22 × 30	0.25	EAJ-800VSN821MP30S		820	22 × 40	0.25	EAJ-1C1VSN821MP40S	
1,000	22 × 30	0.25	EAJ-800VSN102MP30S		820	25.4 × 35	0.25	EAJ-1C1VSN821MQ35S	
1,200	22 × 35	0.25	EAJ-800VSN122MP35S		1,000	22 × 45	0.25	EAJ-1C1VSN102MP45S	
1,200	25.4 × 30	0.25	EAJ-800VSN122MQ30S		1,000	25.4 × 40	0.25	EAJ-1C1VSN102MQ40S	
1,500	22 × 40	0.25	EAJ-800VSN152MP40S		1,000	30 × 30	0.25	EAJ-1C1VSN102MR30S	
1,500	25.4 × 35	0.25	EAJ-800VSN152MQ35S		1,200	25.4 × 45	0.25	EAJ-1C1VSN122MQ45S	
1,500	30 × 25	0.25	EAJ-800VSN152MR25S		1,200	30 × 35	0.25	EAJ-1C1VSN122MR35S	
1,800	22 × 45	0.25	EAJ-800VSN182MP45S		1,500	25.4 × 50	0.25	EAJ-1C1VSN152MQ50S	
1,800	25.4 × 35	0.25	EAJ-800VSN182MQ35S		1,500	30 × 40	0.25	EAJ-1C1VSN152MR40S	
1,800	30 × 30	0.25	EAJ-800VSN182MR30S		1,500	35 × 35	0.25	EAJ-1C1VSN152MA35S	
2,200	22 × 50	0.25	EAJ-800VSN222MP50S	1,800	25.4 × 55	0.25	EAJ-1C1VSN182MQ55S		
2,200	25.4 × 40	0.25	EAJ-800VSN222MQ40S	1,800	30 × 45	0.25	EAJ-1C1VSN182MR45S		
2,200	30 × 35	0.25	EAJ-800VSN222MR35S	1,800	35 × 35	0.25	EAJ-1C1VSN182MA35S		
2,200	35 × 30	0.25	EAJ-800VSN222MA30S	2,200	30 × 50	0.25	EAJ-1C1VSN222MR50S		
2,700	25.4 × 50	0.25	EAJ-800VSN272MQ50S	2,200	35 × 40	0.25	EAJ-1C1VSN222MA40S		
2,700	30 × 40	0.25	EAJ-800VSN272MR40S	2,700	30 × 60	0.25	EAJ-1C1VSN272MR60S		
2,700	35 × 30	0.25	EAJ-800VSN272MA30S	2,700	35 × 50	0.25	EAJ-1C1VSN272MA50S		
				3,300	35 × 55	0.25	EAJ-1C1VSN332MA55S		
				3,900	35 × 60	0.25	EAJ-1C1VSN392MA60S		

Product specifications in this catalog are subject to change without notice. Request our product specifications before purchase and/or use. Please use our products based on the information contained in this catalog and product specifications.

Technical Note

Judicious Use of Aluminum Electrolytic Capacitors

Contents

1. Overview of Aluminum Electrolytic Capacitors

- 1 – 1 Basic Model of Aluminum Electrolytic Capacitors
- 1 – 2 Basic Structure of Aluminum Electrolytic Capacitors
- 1 – 3 Features of Capacitor Materials
- 1 – 4 Manufacturing process

2. Basic Performance

- 2 – 1 Basic Electrical Characteristics (capacitance, $\tan \delta$ and leakage current)
- 2 – 2 Frequency Characteristics of Impedance

3. Reliability

4. Failure Modes

5. Lifetime of Aluminum Electrolytic Capacitors

- 5 – 1 Ambient Temperature Effect on Lifetime
- 5 – 2 Applying Voltage Effect on Lifetime
- 5 – 3 Ripple Current Effect on Lifetime
- 5 – 4 Charge and Discharge Operation Effect on Lifetime
- 5 – 5 Inrush Current
- 5 – 6 Abnormal Voltage Effect on Lifetime

6. Effect of Halogens

- 6 – 1 Effect of Flux
- 6 – 2 Cleaning Agents
- 6 – 3 Adhesive and Coating Materials
- 6 – 4 Effect of Fumigation

7. Recovery Voltage Phenomena

8. Storage

9. Tips for Selecting Capacitors Appropriate for Individual Applications

- 9 – 1 Input Filtering Capacitors for Switching Mode Power Supplies
- 9 – 2 Output Filtering Capacitors for Switching Mode Power Supplies
- 9 – 3 Filtering Capacitors for Inverter Main Circuits
- 9 – 4 Capacitors for Control Circuits
- 9 – 5 Photoflash Capacitors



1. Overview of Aluminum Electrolytic Capacitors

1-1 Basic Model of Aluminum Electrolytic Capacitors

Capacitors are passive components. Among the various kinds of capacitors, aluminum electrolytic capacitors offer larger CV product per case size and lower cost than the others.

In principles of capacitor, its fundamental model is shown in Fig. 1 and its capacitance (C) is expressed by Equation (1) below:

$$C = 8.854 \times 10^{-12} \frac{\epsilon S}{d} \text{ (F)} \dots\dots\dots (1)$$

- ϵ : Dielectric constant
- S : Surface area of dielectric (m²)
- d : Thickness of dielectric (m)

Equation (1) shows that the capacitance (C) increases as the dielectric constant (ϵ) and/or its surface area (S) increases and/or the dielectric thickness (d) decreases.

An aluminum electrolytic capacitor comprises a dielectric layer of aluminum oxide (Al₂O₃), the dielectric constant (ϵ) of which is 8 to 10. This value is not significantly larger than those of other types of capacitors.

However, by extending the surface area (S) of the aluminum foil electrode by means of etching, and by electrochemically forming a thinner but highly voltage-withstandable layer of oxide layer dielectric, the aluminum electrolytic capacitor can offer a larger CV product per case size than other types of capacitors.

A basic model of aluminum electrolytic capacitor is shown in Fig. 2. An aluminum electrolytic capacitor comprises:

- Anode ...Aluminum foil
- Dielectric...Electrochemically formed oxide layer (Al₂O₃) on the anode
- Cathode ...A true cathode is electrolytic solution (electrolyte).

Other component materials include a paper separator that holds electrolyte in place and another aluminum foil that functions as a draw-out electrode coming into contact with the true cathode (electrolyte).

In general, an aluminum electrolytic capacitor is asymmetrical in structure and polarized. The other capacitor type known as a bi-polar (non-polar) comprises the anodic aluminum foils for both electrodes.

1-2 Structure of Aluminum Electrolytic Capacitor

The aluminum electrolytic capacitor has, as shown in Fig. 3, a roll of anode foil, paper separator, cathode foil and electrode terminals (internal and external terminals) with the electrolyte impregnated, which is sealed in an aluminum can case with a sealing material.

The terminal draw-out structure, sealing material and structure differ depending on the type of the capacitor.

Figure 4 shows typical examples.

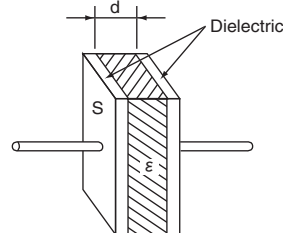
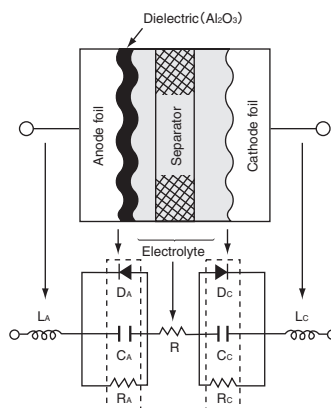

Fig-1 Basic model of capacitor



- C_A, C_C : Capacitance due to anode and cathodes foils
- D_A, D_C : Diode effects due to oxide layer on anode and cathode foils
- L_A, L_C : Inductance due to anode and cathode terminals
- R : Resistance of electrolyte and separator
- R_A, R_C : Internal resistance of oxide layer on anode and cathode foils

Fig-2 Basic model and equivalent circuit of aluminum electrolytic capacitor

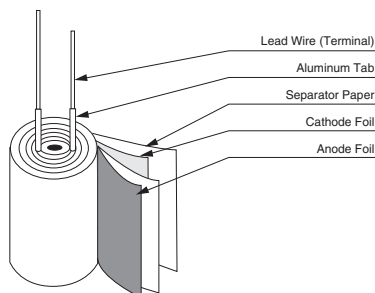

Fig-3 Basic model of element

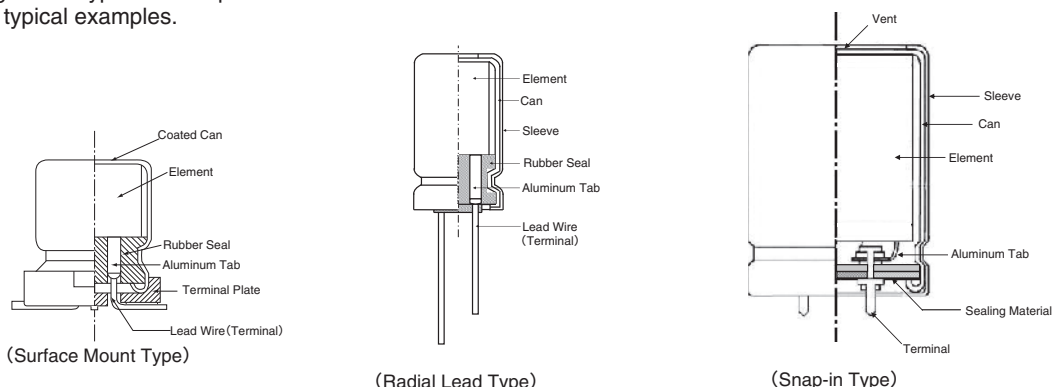

Fig-4 Construction of Aluminum Electrolytic Capacitors

1-3 Features of Capacitor Materials

Aluminum, which is main material in an aluminum electrolytic capacitor, forms an oxide layer (Al_2O_3) on its surface when the aluminum is set as anode and charged with electricity in electrolyte.

The aluminum foil with an oxide layer formed thereon, as shown in Fig. 5, is capable of rectifying electric current in electrolyte. Such a metal is called a valve metal.

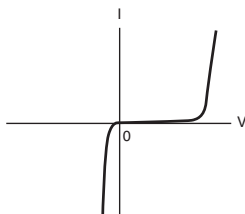

Fig-5 V-I characteristics of aluminum oxide

<Anode aluminum foil>

First, the foil material is electromechanically etched in a chloride solution to extend the surface area of the foil.

Secondly, for the foil to form an aluminum oxide layer (Al_2O_3) as a dielectric, more than the rated voltage is applied to the foil in a solution such as ammonium borate. This dielectric layer is as dense and thin as 1.1 - 1.5 nm/volt and showing a high insulation resistance ($10^8 - 10^9 \Omega/\text{m}$).

The thickness of the oxide layer determines the withstand voltage according to their direct proportional relationship. For the etching pits to be shaped to the intended thickness of the oxide layer, the pit patterns have been designed to have efficient surface area extension depending on the intended withstand voltage (see Fig. 6)

<Cathode aluminum foil>

An etching process is performed to the cathode aluminum foil as well as the anode foil. However, the formation process for oxide layer is generally not performed. Therefore, the surface of the cathode foil only has an oxide layer (Al_2O_3) that has spontaneously formed, which gives a withstand voltage of about 0.5 volt.

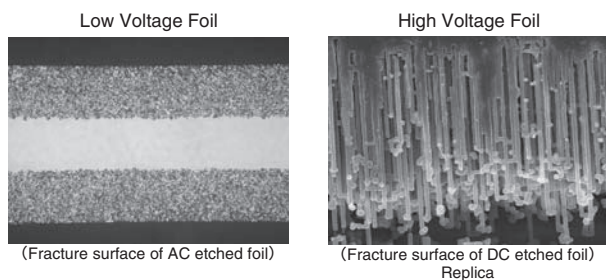

Fig-6 Cross section of aluminum etched foil (SEM)

<Electrolyte>

The electrolyte, an ion-conductive liquid functions as a true cathode coming into contact with the dielectric layer on the surface of the anode foil. The cathode foil serves as a collector electrode to connect the true cathode with the external circuit. Electrolyte is an essential material that controls the performance of the capacitor (temperature characteristics, frequency characteristics, service life, etc.).

<Paper separator >

The separator maintains uniform distribution of the electrolyte and keeps the anode-to-cathode foil distance unchanged.

<Can case and sealing materials>

An aluminum can case and seal materials mainly consisting of rubber are used for the purpose of keeping airtightness.

1-4 Manufacturing Process

① Etching (for extending the surface area)

This etching process serves to extend the surface area of the aluminum foil. This is an AC or DC current-employed electrochemical process for etching the foil surface in a chloride solution.

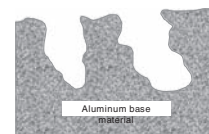

Etching Model

② Formation (for forming a dielectric)

This is a process for forming a dielectric layer (Al_2O_3), which is normally performed on the anode aluminum foil.

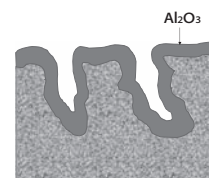

Forming Model

③ Slitting

This is a process for slitting aluminum foils (both the anode and cathode) and paper separators to the specified product size.

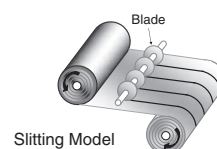

Slitting Model

④ Winding

This is a process for rolling a set of anode and cathode foils into a cylindrical form with a paper separator inserted between them. During this process, an inner terminal (called a tab) is attached to each of the aluminum foils. The roll made at this process is called a capacitor element.

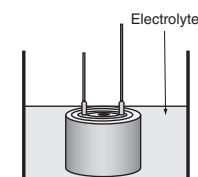
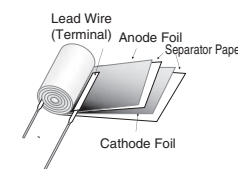

Impregnation

⑤ Impregnation

This is a process for impregnating the element with electrolyte as a true cathode. The electrolyte also functions to repair the dielectric layer.

⑥ Sealing

This process seals the element using the aluminum can case and sealing materials (rubber, rubber-lined cover, etc.) for keeping the case airtight.

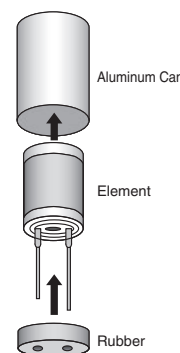

⑦ Aging (reforming)

The process of applying voltage to a post-sealed capacitor at high temperature is called "aging". This serves to repair defective dielectrics that have been made on the foil during the slitting or winding process.

⑧ 100% inspection and packaging

After the aging, all products shall undergo testing for checking their electrical characteristics with chip termination, lead reforming, taping etc. finished, and then be packaged.

⑨ Outgoing inspections

Outgoing inspections are performed as per standard inspection procedures.

⑩ Shipment



2. Basic Performance

2-1 Basic Electrical Characteristics

2-1-1 Capacitance

The larger the surface area of an electrode is, the higher the capacitance (capacity for storing electricity) is. For aluminum electrolytic capacitors, the capacitance is measured under the standard measuring conditions of 20°C and a 120Hz AC signal of about 0.5V. Generally, as the temperature rises, the capacitance increases; as the temperature decreases, the capacitance decreases (Fig. 7). With a higher frequency, the capacitance is smaller; with a lower frequency, the capacitance is larger (Fig. 8).

2-1-2 $\tan \delta$ (also called tangent of loss angle or dissipation factor)

(Fig. 9) is a simplified model of the equivalent circuit shown in (Fig. 2). For an ideal capacitor with an equivalent series resistance of $R = 0$, the $\tan \delta$ shown in (Fig. 10) is zero. For an aluminum electrolytic capacitor, the equivalent series resistance (R) is not zero due to the presence of resistance of the electrolyte and paper separator and other contact resistances. $1/\omega C$ and R are correlated as shown in (Fig. 10) and Equation (2).

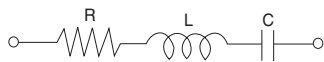

Fig-9 Simplified equivalent circuit

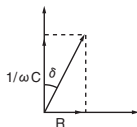

Fig-10 Dissipation Factor ($\tan \delta$)

$$\tan \delta = \frac{R}{1/\omega C} = \omega CR \dots\dots\dots (2)$$

$\omega : 2\pi f$
 $\pi = \text{Circular constant, } f : \text{Frequency (} f = 120\text{Hz)}$

2-1-3 Leakage Current (LC)

As a feature of an aluminum electrolytic capacitor, when DC voltage is applied to it, the oxide layer that acts as a dielectric in the electrolyte allows a small amount of electric current to flow in it. The small amount of current is called a leakage current (LC). An ideal capacitor does not allow the leakage current to flow (this is not the case for charging current).

The leakage current (LC) changes with time as shown in (Fig. 12). Note that LC, decreasing with time, will reach a steady-state value. Therefore, the specifications of LC are defined as a value measured several minutes after the beginning of the application of the rated voltage at 20°C. As the temperature rises, the LC increases; as the temperature decreases, the LC decreases (Fig.13). As the applied voltage decreases, the LC decreases.

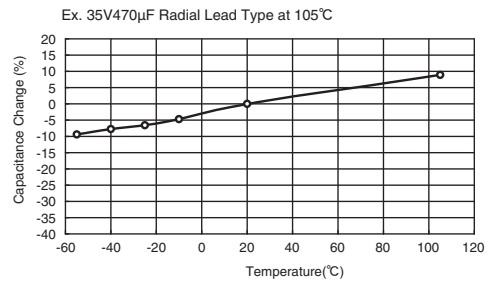

Fig-7 Temperature Characteristics of Capacitance

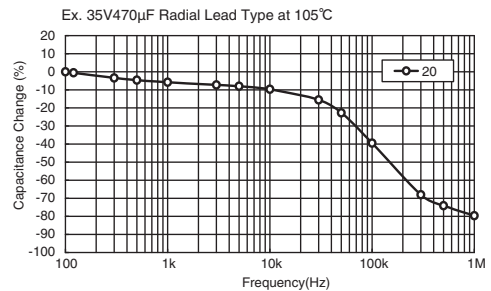

Fig-8 Frequency Characteristics of Capacitance

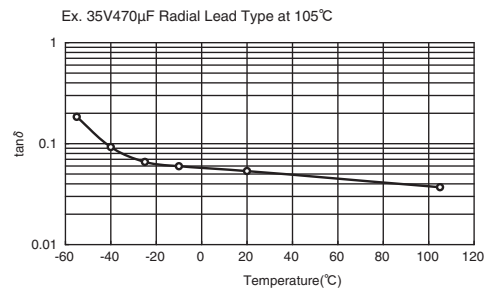

Fig-11 Temperature Characteristics of $\tan \delta$

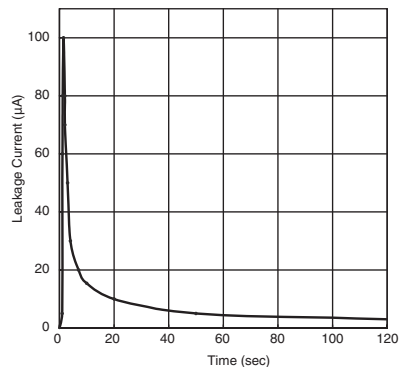

Fig-12 Leakage Current vs. Time

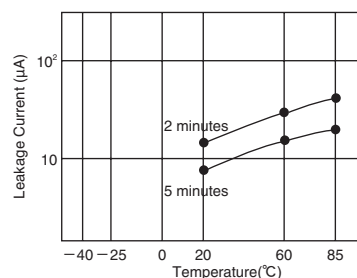

Fig-13 Temperature Characteristics of Leakage Current



2-2 Frequency Characteristics of Impedance (Z)

When a capacitor is applied with a voltage with the frequency changed, the impedance (Z), a factor of preventing the AC current changes as shown in (Fig. 14). This is the impedance-frequency characteristics of the capacitor.

(Fig. 9) is a simplified model of an equivalent circuit of an aluminum electrolyte capacitor. (Fig. 14) shows dotted lines representing a breakdown of the impedance-frequency characteristic curve into components (C, R and L). As can be seen in this figure, the impedance-frequency characteristics are a composition of C, R and L frequency characteristics.

The value $1/\omega C$ shows the pure capacitive reactance graphically presented by a straight line going downward at an angle of 45° , and ωL shows the pure inductive reactance graphically presented by a straight line going upward at 45° . R shows the equivalent series resistance (ESR). At a range of lower frequencies, the R curve goes downward due to the dielectric loss frequency-dependence. At a range of higher frequencies, the R curve tends to be almost flat since resistance of electrolyte and paper separator is dominant and independent on frequency. Equation (3) shows this tendency.

$$Z = \sqrt{R^2 + \left(\omega L - \frac{1}{\omega C}\right)^2} \dots\dots\dots (3)$$

Because the impedance characteristics of an aluminum electrolyte capacitor depend on resistance of the electrolyte and paper separator, the Z value at the self-resonant frequency tends to be relatively higher, as shown by the solid line in (Fig. 15). The resistance of the electrolyte varies depending on temperature: as the temperature rises, the impedance decreases; and as the temperature decreases, the impedance increases, as shown in (Fig. 16).

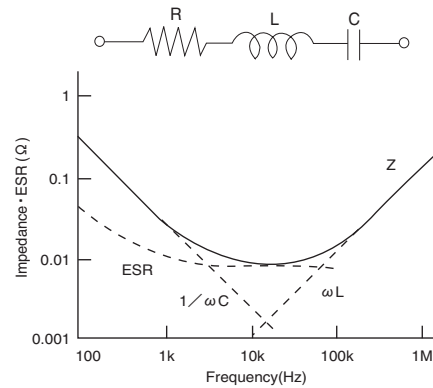

Fig-14 Factor of Impedance Frequency

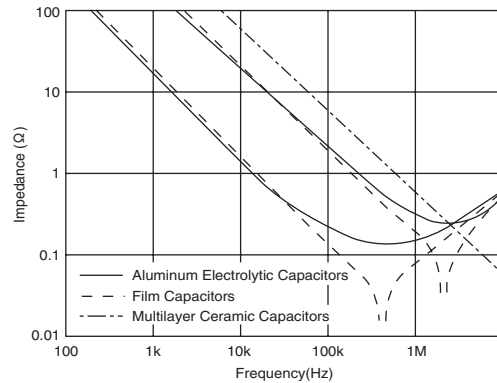

Fig-15 Frequency Characteristics of each Capacitors Impedance

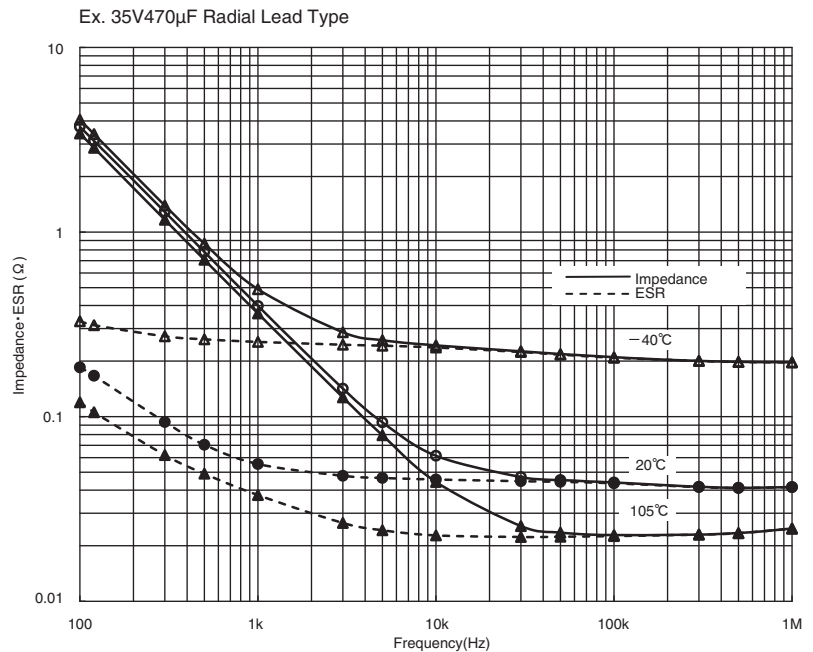

Fig-16 Temperature and Frequency Characteristics of Impedance · ESR



3. Reliability

For designing the device with aluminum electrolytic capacitors, a failure rate and useful life are necessary to be considered for their reliability. The failure rate of aluminum electrolytic capacitors is approximated by the bathtub curve shown in (Fig.17).

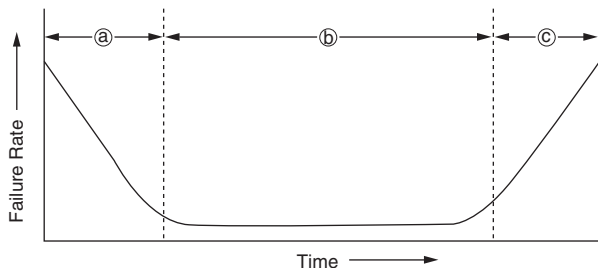

Fig-17 Bathtub curve

- (a) Early failure period**
At the comparatively early periods of use, devices/components fail by deficiencies in design or manufacturing process or incompatibility with operation conditions. For aluminum electrolytic capacitors, these defectives are removed by debugging at one of manufacturing processes before shipments.
- (b) Random failure period**
Failure is stable low in occurrence and appears unrelated to their served term. Aluminum electrolytic capacitors are low in catastrophic failures in this period compared with semi-conductors and solid tantalum capacitors.
- (c) Wear-out failure period**
In this period, the failure rate increases with the served time. For aluminum electrolytic capacitors, since they were completed in manufacturing, the electrolyte impregnated has gradually evaporated and diffused out of the capacitors through the rubber seal materials with time, which leads to decrease in the capacitance and/or increase $\tan\delta$. When any of these values changes beyond the allowable range of specifications, the capacitors are defined as "fell into the wear-out failure". The served term until the capacitors fall into the wear-out failure period is called a useful life.

Aluminum electrolytic capacitors have two categories of failures: catastrophic failure and wear-out failure.

<Catastrophic failure>

This is a failure mode that completely destroys the function of the capacitor such as short circuit and open circuit failure.

<Wear-out failure>

This is a failure mode where the electrical parameters of the capacitor gradually deteriorate and fail. The criteria for determining if this failure has occurred depend on the purpose of a device. For each series of capacitors, the following electrical parameters have been defined as criteria in the specifications of Endurance in the catalogs or product specifications:

- Change in capacitance
- $\tan\delta$
- Leakage current

Failure rates are often measured in units of % per 1000 hours ($10^{-5}/\text{hour}$). For higher reliability devices designed with a smaller failure rate, units of Failure In Time (FIT) ($10^{-9}/\text{hour}$) is used.

Aluminum electrolytic capacitors are considered as components of wear-out failure mode, the electrical characteristics of which gradually deteriorate and their failure rate increases with time. In general, the failure rate in FIT is determined by total component-hours (product of the number of tested components and test hours).

Due to the definition of FIT, the same FIT rate can be calculated in both cases of testing on the large number of tested components and also testing for long test periods of time. However, these cases mean differently for aluminum electrolytic capacitors. Using the failure rate is not suited to express the reliability of aluminum electrolytic capacitors, but the electrical characteristics based lifetime in hour should be considered to express the reliability.

Also, there are MTBF (Mean Time Between Failures) and MTTF (Mean Time To Failure) to express reliability. The latter is applicable for aluminum electrolytic capacitors because they are categorized into a group of non-repairable systems, equipment and devices for which MTTF is applicable.

4. Failure Modes

Failure modes depend on the application conditions that lead to fail. (Fig. 18).

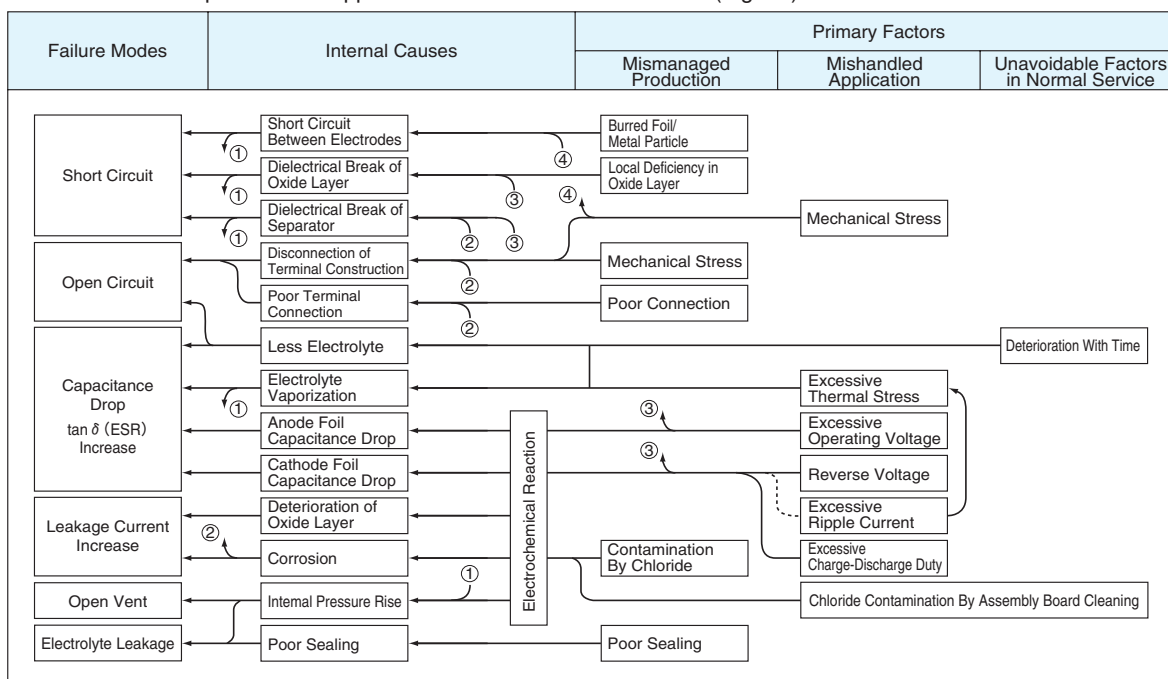

Fig-18 Failure Modes



5. Lifetime

The lifetime of aluminum electrolytic capacitors is largely dependent on the application conditions. Environmental factors include temperature, humidity, atmospheric pressure and vibrations. Electrical factors include operating voltage, ripple current and charge-discharge. Where the capacitors are used in a normal filtering circuit, ambient temperature and heating due to the ripple current are crucial factors for determining the lifetime of the capacitors. These factors are included to the lifetime specifications titled "Endurance" on the catalogs or product specifications. For applications subject to high humidity and/or continuous vibrations, or subject to frequent charge and discharge operations, the endurance of individual conditions should be considered.

5-1 Ambient Temperature Effect on Lifetime

The lifetime of aluminum electrolytic capacitors is affected mainly by the loss of electrolyte as the result of diffusion through the rubber seal materials, which leads to a decrease in capacitance and increase in $\tan \delta$.

The relationship of temperature to the diffusion of electrolyte follows the Arrhenius' Law (Equations (4) and (5)):

$$k = Ae^{\frac{-E}{RT}} \dots\dots\dots (4)$$

$$\ln k = \left(\frac{-E}{RT} \right) + \ln A \dots\dots\dots (5)$$

- k : Reaction rate constant
- A : Frequency factor
- E : Activation energy
- R : Gas constant (8.31J/deg)
- T : Absolute temperature (K)

Applying Equation (5) to the lifetime of the capacitors brings Equation (6), which is converted to Equation (7):

$$\log \left(\frac{L_x}{L_o} \right) = \frac{E}{2.303R} \left(\frac{1}{T_x} - \frac{1}{T_o} \right) \dots\dots\dots (6)$$

$$\log L_x = \frac{E}{2.303R} \left(\frac{1}{T_x} - \frac{1}{T_o} \right) + \log L_o \dots\dots\dots (7)$$

Practical estimation of the lifetime has been using Equation (8) as an approximation:

$$L_x = L_o \cdot Bt^{(T_o - T_x)/10} \dots\dots\dots (8)$$

- L_o : Specified lifetime (hour) with the rated voltage applied (or the rated ripple current superimposed to a DC voltage) at the upper limit of the category temperature. Refer to the lifetime specifications of individual products.
- L_x : Estimated life on actual usage (hour)
- T_o : Maximum Category Temperature ($^{\circ}C$)
- T_x : Actual Ambient Temperature ($^{\circ}C$)
- Bt : Temperature acceleration factor

Where, the temperature acceleration factor (BT) is approximately 2 over an ambient temperature range from $60^{\circ}C$ to $95^{\circ}C$, which means that the lifetime is approximately halved for every $10^{\circ}C$ rise in ambient temperature. However, according to the Arrhenius Equation (6), the reciprocal of T is directly proportional to the logarithm of lifetime, which means that, strictly speaking, there is the temperature range where the theory of lifetime reducing by half at every $10^{\circ}C$ rise is not applied. (Fig. 19).

Especially for capacitors whose maximum operating temperature is a $105^{\circ}C$ or higher, the temperature acceleration factor (BT) needs to be modified depending on temperature ranges of the lifetime estimation. For details, please consult us.

For lifetime estimation at a lower-temperature range, evaluation test data have not been obtained, and for evaluating long term endurance, it is necessary to take into account some additional factors such as deterioration of the rubber seal materials as well as the diffusion of electrolyte. Accordingly, in Equation (8), T_x should be $40^{\circ}C$ at the lowest for the lifetime calculation purpose, and also the estimated lifetime (L_x) should be 15 years at the longest.

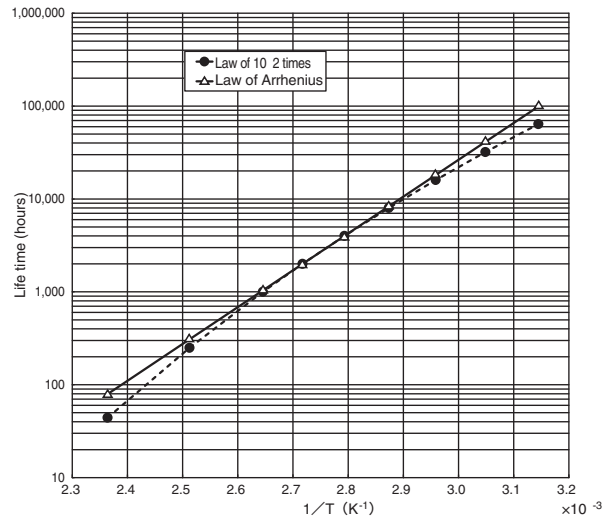

Fig-19 Estimated result by Law of $10^{\circ}C$ 2 times and Law of Arrhenius

5-2 Applying Voltage Effect on Lifetime

Where a capacitor is used at lower than the rated voltage, the lifetime may not be adversely affected, which means that the effect of the applying voltage is negligibly small, while the effect of the ambient temperature and heat generation due to ripple current is significant.

(Fig-20)

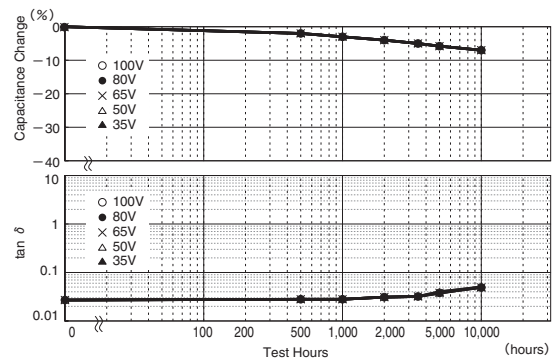

Fig-20 Endurance (measured by each apply voltage, result curves are overlapped)
Note: Due to the very small effect of the applying voltages, the plots cannot be distinguished from one another.

However, for capacitors of larger size and higher rated voltage contain a larger volume of electrolyte, difference in applying voltages can affect degradation of the oxide layer, other than the diffusion of electrolyte.

Therefore, for screw mount terminal type capacitors with the rated voltage of 350Vdc or higher, the lifetime estimation includes the effect of applying a lower voltage than the rated voltage (derating voltage).



5-3 Ripple Current Effect on Lifetime

Since an aluminum electrolytic capacitor has a larger $\tan\delta$ than other types of capacitors, the capacitor produces more internal heat when a ripple current flows through it. The temperature rise due to this heat may significantly affect the lifetime of the capacitor. This is the reason why ripple current ratings are specified for capacitors.

5-3-1 Heat Generation due to Ripple Current

Power consumption by the ripple current can be expressed as follows:

$$W = I_R^2 R + V I_L \dots\dots\dots (9)$$

- W : Internal power dissipation
- I_R : Ripple Current
- R : Internal Resistance (Equivalent Series Resistance)
- V : Applied voltage
- I_L : Leakage Current

Leakage current I_L at the maximum operating temperature can be 5 to 10 times higher than the values measured at 20°C. However, considering $I_R \gg I_L$, the above equation can be simplified as Equation (10).

$$W \approx I_R^2 R \dots\dots\dots (10)$$

To obtain the temperature at which equilibrium is achieved between heat generation and dissipation, derive Equation (11).

$$I_R^2 R = \beta A \Delta T \dots\dots\dots (11)$$

- β : Radiation Constant
- A : Surface area of can case (m^2)
- ΔT : Temperature-rise due to the Ripple Current ($^{\circ}C$)
- $A = \frac{\pi}{4} D (D + 4L)$
- D : Can Diameter (m)
- L : Can Length (m)

From the above equation, the internal temperature rise (ΔT) is given by Equation (12):

$$\Delta T = \frac{I_R^2 R}{\beta A} \dots\dots\dots (12)$$

Also, for a ripple frequency of 120Hz, Equation (12) for calculating ΔT is rewritten as Equation (13):

$$\Delta T = \frac{I_R^2 R}{\beta A} = \frac{I_R^2 \tan \delta}{\beta A \omega C} \dots\dots\dots (13)$$

Where $R = \frac{\tan \delta}{\omega C}$

- $\tan \delta$: Dissipation Factor at 120Hz
- ω : $2 \pi f$ ($f = 120\text{Hz}$)
- C : Capacitance at 120Hz (F)

An approximate value of ripple current-caused ΔT can be calculated using Equation (14):

$$\Delta T = (I_x / I_o)^2 \times \Delta T_o \dots\dots\dots (14)$$

- I_o : Rated ripple current (Arms), frequency compensated, at the upper limit of the category temperature range
- I_x : Operating ripple current (Arms) actually flowing in the capacitor
- ΔT_o : Rise in internal temperature due to the rated ripple current ($^{\circ}C$): different for each product series. Please consult us.

There are some product families that can accept a higher ripple current than the rated value providing that ambient temperature T_x is lower than the upper limit of the category temperature range. However, in this case, remember that the lifetime decreases due to the higher ΔT due to the ripple current. Be sure that ΔT does not exceed the specified limit that has been determined as a function of ambient temperature. Note that the core temperature limit of the element is shown by $[T_x + \Delta T \text{ limit}]$.

Examples of ΔT limits at some ambient temperatures are shown below.

Ambient Temp T_x	85°C less or equal	105°C
Limit value of ΔT	15°C	5°C

Each product family has a different ΔT limit. For details, consult us.

5-3-2 Ripple Current and Frequency

The ripple current rating is specified normally by the effective value (r.m.s value) of 120Hz or 100kHz sine wave. However, since the equivalent series resistance

(ESR) of a capacitor is frequency-dependent, the allowable ripple current depends on the frequency. Where the operating ripple current consists of a mains power frequency element and switching frequency element(s) like switching mode power supplies do, the internal power loss is expressed by Equation (15):

$$W = I_{r1}^2 R_{r1} + I_{r2}^2 R_{r2} + \dots\dots I_{rn}^2 R_{rn} \dots\dots\dots (15)$$

- W : Power consumption
- $I_{r1}, I_{r2}, \dots, I_{rn}$: Ripple current (Arms) at frequency $f1 \dots fn$
- $R_{r1}, R_{r2}, \dots, R_{rn}$: ESR (Ω) at $f1 \dots fn$

Given a frequency compensation factor (Frequency Multiplier) = F_{in} and reference frequency for the ripple current = f_o , $R_{rn} = R_{fo} / F_{in}^2$ is obtained. Therefore, the ripple current at any frequency can be converted into its r.m.s. value at the reference frequency (I_{fo}) using Equation (16):

$$I_{fo} = \sqrt{(I_{r1}/F_{f1})^2 + (I_{r2}/F_{f2})^2 + \dots\dots (I_{rn}/F_{fn})^2} \dots\dots\dots (16)$$

- I_{fo} : Reference ripple current (Arms), i.e., that at the reference frequency
- $F_{f1}, F_{f2}, \dots, F_{fn}$: Frequency compensation factor (Frequency Multiplier) at frequency $f1 \dots fn$ (Refer to the catalogs)

Note that the ESR depends on the temperature and the value of β depends on the installation conditions of the capacitor on the board. To determine more accurate values of ΔT , they can be actually measured using a thermocouple.

5-3-3 Lifetime Estimation

Equations (17) through (19) can be used for estimating the lifetime of a non-solid aluminum electrolytic capacitor based on the ambient temperature, the rise of internal temperature due to ripple current, and operating voltage applied.

For a capacitor whose Endurance specifications are defined by only "the DC rated voltage".

$$L_x = L_o \times 2^{\frac{T_o - T_x}{10}} \times 2^{\frac{-\Delta T}{5}} \dots\dots\dots (17)$$

For a capacitor whose Endurance specifications are defined by "the rated ripple current with a DC voltage superimposed".

$$L_x = L_r \times 2^{\frac{T_o - T_x}{10}} \times 2^{\frac{\Delta T_o - \Delta T}{5}} \dots\dots\dots (18)$$

For a screw terminal type capacitor with the rated voltage of 350Vdc or higher

$$L_x = L_r \times 2^{\frac{T_o + 5 - T_x - 25}{10}} \times 2^{\frac{25 - \Delta T}{A}} \times K_v \dots\dots\dots (19)$$

- L_o : Specified lifetime (hour) at the upper limit of the category temperature range and at the rated voltage
- L_r : Specified lifetime (hour) at the upper limit of the category temperature range and at the rated ripple current superimposed to a DC voltage
- L_x : Estimation of actual lifetime (hour)
- T_o : Upper limit of the category temperature range ($^{\circ}C$)
- T_x : Actual ambient temperature of the capacitor ($^{\circ}C$)
Use 40°C if the actual ambient temperature is below it.
- ΔT : Rise of internal temperature due to actual ripple current ($^{\circ}C$)
- * ΔT_o : Rise of internal temperature due to the rated ripple current ($^{\circ}C$)
- * A : This factor depends on the ripple frequency and internal temperature rise.
- K_v : Derating voltage factor

For the values marked with * , consult us.

Please consult us about lifetime equations for the series of the category temperature 125°C or more.

Subject series : MVH, MHL, MHB, MHJ, MHK, GPA, GVA, GXF, GXE, GXL, GPD, GVD.

Note that the calculation results above are not considered as a guaranteed value. When designing the lifetime of a device, please select a capacitor that has an extra margin against the device lifetime requirements. Also, where the estimation result calculated exceeds 15 years, please consider 15 years to be a maximum. If 15 years or more may be required as an expected lifetime, please consult us.



5-4 Charge and Discharge Operation Effect on Lifetime

Applying a voltage to an aluminum electrolytic capacitor makes the electric charges accumulate on the anode foil dielectric. Discharging the electricity through a discharging resistance makes the electric charges move to the cathode foil and cause chemical reactions between the cathode aluminum and electrolyte, thereby forming a dielectric oxide layer.

When this charge and discharge is repeatedly operated, the chemical reactions proceed to further form the oxide layer on the cathode foil, causing the capacitance of the cathode foil to reduce and thereby reducing the capacitance of the capacitor. Moreover, the chemical reactions bring heat and gases. Depending on the charge and discharge conditions, the internal pressure may increase, the pressure relief vent may open or the capacitor may have destructive failures. Consult us for using a capacitor with the following applications:

- Frequently repeating power on/off.
- Repeating rapid charge and discharge operations at a short interval cycle.
- Repeating charge and discharge operations with a large voltage drop.

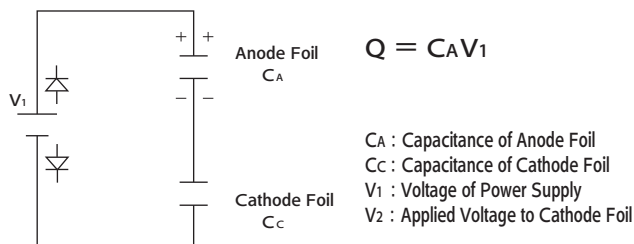

Fig-21 Charge Condition at Charge

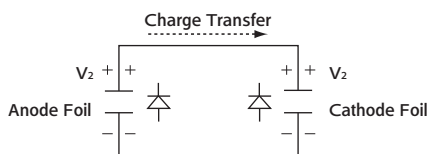

Fig-22 Charge Condition at Discharge (Disconnect V1 and Discharged condition)

$$Q = C_A V_2 + C_C V_2$$

then $C_A V_1 = C_A V_2 + C_C V_2$

$$V_2 = \frac{C_A V_1}{C_A + C_C} \dots\dots\dots (20)$$

Figures 23 through 25 show some test data of special-design capacitors for charge and discharge application, compared with general-purpose capacitors.

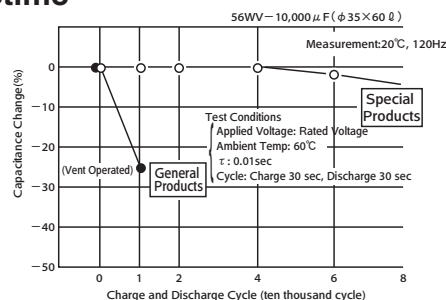

Fig-23 Rapid charge and discharge characteristics (Effects of Frequency)

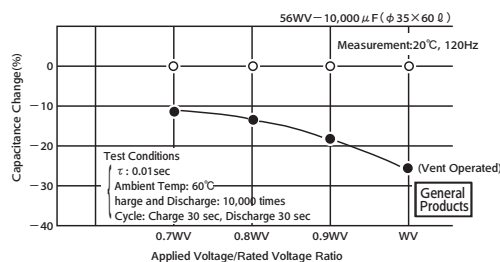

Fig-24 Rapid charge and discharge characteristics (Effects of Applied Voltage)

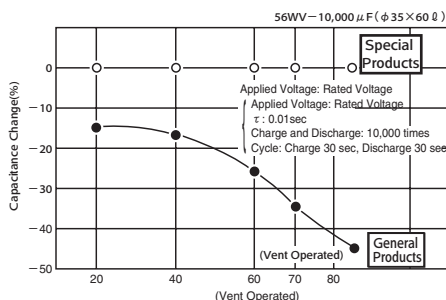

Fig-25 Rapid charge and discharge characteristics (Effects of Ambient Temperature)

5-5 Inrush Current

For the power supply inrush current that can occur on the start-up of a power supply or on the charge of a welding machine lasts only milliseconds, but its magnitude may reach 10 to 1,000 times more than the normal current. Usually, a single, non-repeated inrush current produces a negligibly small amount of heat, so it does not matter.

However, frequently repeating inrush currents may heat up the element inside a capacitor more than the allowable limit and/or overheat the external terminal connections or the connections between the internal lead and foil electrode.



5-6 Abnormal Voltage Effect on Lifetime

Applying abnormal voltage can increase the internal pressure with heat and gases produced, causing the pressure relief vent to open or the capacitor to have destructive failures.

5-6-1 Overvoltage

Applying a voltage higher than the rated voltage will cause chemical reactions (formation of dielectric) to occur on the anode foil with the leakage current rapidly increasing, which produces heat and gases and thereby increases the internal pressure.

The reactions are accelerated by the voltage, current density and ambient temperature, causing the pressure relief vent to open or the capacitor to have destructive failures. It may also accompany a reduction in capacitance and an increase in $\tan \delta$ as well as an increase in the leakage current, which can lead to internal short-circuiting failure. An example of capacitor overvoltage characteristics is shown in Fig. 26.

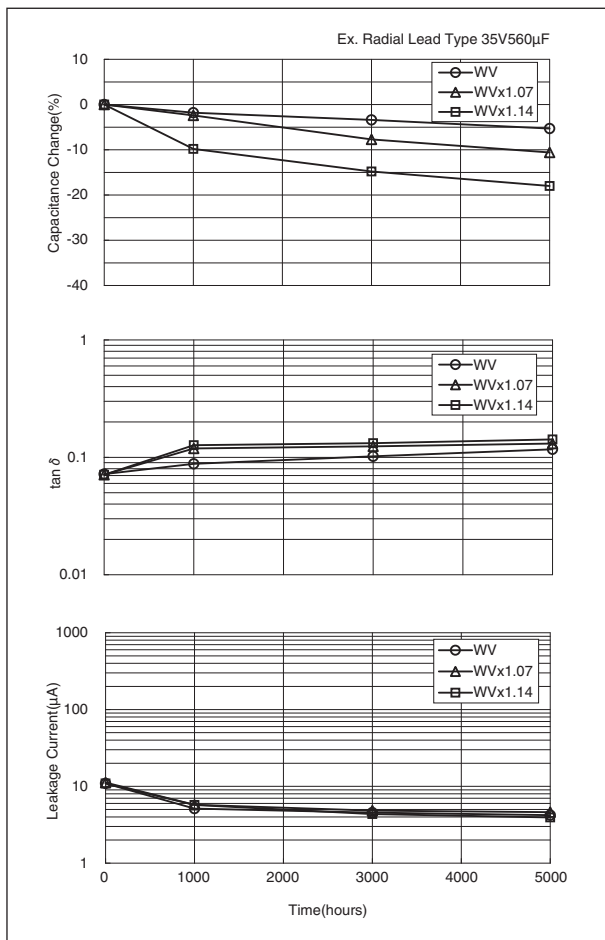

Fig-26 Applied overvoltage characteristic at 105°C

5-6-2 Reverse Voltage

Applying a reverse voltage will cause chemical reactions (formation of dielectric) to occur on the cathode foil, and, as is the case with overvoltage, the leakage current will rapidly increase with heat and gases generating and thus the internal pressure increases.

The reactions are accelerated by the voltage, current density and ambient temperature. It may also accompany a reduction in capacitance and an increase in $\tan \delta$ as well as an increase in the leakage current. An example of capacitor reverse-voltage characteristics is shown in Fig. 27.

A reverse voltage of as small as 1V can cause the capacitance to decrease. A reverse voltage of 2 to 3V can shorten lifetime due to a reduction in capacitance, increase in $\tan \delta$, and/or increase in leakage current. A reverse voltage of even higher value can open the pressure relief vent or lead to destructive failures (Fig. 27).

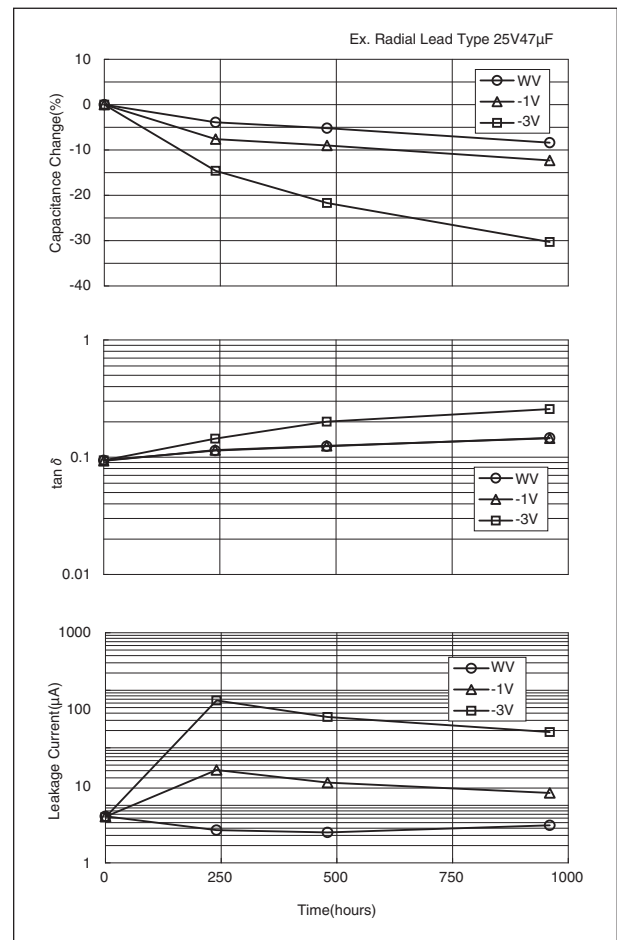

Fig-27 Applied Reverse voltage characteristic at 105°C

5-6-3 Do not Use Aluminum Electrolytic Capacitors in an AC Circuit

Using an aluminum electrolytic capacitor in an AC circuit will result in the same situation as that with a positive potential being applied to the cathode (like a reverse voltage) and with an excessively large ripple current flowing in the capacitor, which may increase the internal pressure due to the generation of heat and gases, open the pressure relief vent, leak the electrolyte with the rubber seal bung expelled or cause the capacitor to blow up or catch fire in the worst case. If the capacitor blows up, it may scatter flammable materials such as electrolyte and element-supporting wax materials, which can lead to short-circuiting of the device. Therefore, do not use aluminum electrolytic capacitors in any of the AC circuits.



6. Effect of Halogens

Aluminum electrolytic capacitors are sensitive to contamination of halogen ions (especially to chlorine and bromine ions) though the degree of the effect depends on the properties of the electrolyte and/or sealing materials used in the capacitors. For using a halide-containing flux, solvent (cleaning agent, adhesive or coating materials) or fumigant, the halide may penetrate into the capacitor through the rubber seal materials and cause the following corrosion reactions to occur. These reactions can lead to an increase in leakage current, opening of the pressure relief vent, and/or open-circuit failure in the capacitor. The reactions are accelerated as the voltage and/or temperature rises.

[Corrosion reactions]

a) Decomposition of halides



b) Corrosion reactions

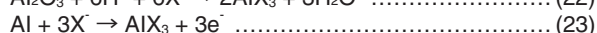
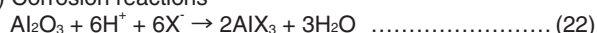

RX : Halogenated compound

X⁻ : Halogen ions (Cl⁻, F⁻, Br⁻)

Halides that penetrated the element inside a capacitor make contact with the electrolyte, by which the halides are hydrolyzed and release halogen ions as shown on Reaction (21). The halogen ions then attack aluminum by anodic half-cell reaction, producing AlX₃ (Reaction 22 and 23).

AlX₃ is then hydrolyzed, which is decomposed to aluminum hydroxide and the halogen ions (Reaction (24)). The halogen ions reproduced are repeatedly used and reproduced by the reactions of (22) ~ (24), and then the corrosion develops endlessly.

Shown below are precautions for use of flux, cleaning agents, adhesive, coating materials and fumigant.

6-1 Effect of Flux

Usually flux products contain an activator of ionic halide system, which has been associated with the corrosion issues of capacitors, and nowadays non-ionic halide system type flux products have been increasingly available on the market. Some of the latter flux type have been classified into the so called "non-halogen flux" or "halogen-free flux", and parts of the "non-halogen" or "halogen-free" flux products may contain a large amount of non-ionic halides, which can also adversely affect the capacitors.

Flux types whose halogen ion concentrations are so low that the capacitor may not be adversely affected include:

- AHQ3100K (Asahi)
- POZ6 (Senjyu)

6-2 Cleaning Agents

6-2-1 Alcohol Cleaning Agents

- ① Fatty-alcohol cleaning agents (New type of solvent)
Pine Alpha ST-100S (Arakawa Chemical)
Clean Through 750H, 750K, 750L, and 710M (Kao)
Technocare FRW-14 through 17 (GE Toshiba Silicones)
- ② IPA (Isopropyl alcohol)

[Compatible capacitor products]

Terminal Shape	Subject Series
Surface Mount Type	All Series
Radial Lead Type	All Series
Snap-in Type	All Series (Less and equal 100V _{dc})

[Cleaning conditions]

Either of Immersion or ultrasonic cleaning, for a maximum of 10 minutes at a maximum liquid temperature of 60°C.

[Precautions]

- a. Make sure that the markings on a capacitor are not rubbed against any other component or the PC board during cleaning. Note that shower cleaning can cause the markings on the capacitor to be washed off.
- b. Depending on the cleaning method, the markings may be erased or blur.
- c. A drying process following a water cleaning or rinsing process may cause the outer sleeve materials of a capacitor to swell or shrink.
- d. After using a weak-alkaline cleaning agent (e.g. Clean Through 750H), rinse with water to make sure that no alkaline residue is left on the capacitor.
- e. Control a flux concentration in a cleaning agent within 2 wt%.
- f. IPS (Isopropyl Alcohol), if containing xylene or other solvent to improve its cleanability, may swell the rubber seal materials.
- g. Depending on the type of cleaning agent or conditions, note that the outer sleeve of a capacitor may lose a gloss or whiten in appearance.

6-2-2 HCFC (Freon-225), as Alternative CFCs

AK225AES (Asahi Glass)

[Cleaning conditions]

Solvent resistant type capacitors, which were originally developed to intend to resist Freon TE or Freon TES, are also capable of withstanding either of immersion or ultrasonic cleaning, for a maximum of 5 minutes (or 2 minutes for KRE and KRE-BP series capacitors or 3 minutes for SRM series). However, in view of global environmental issues, HCFCs has not been recommended.

[Compatible capacitor products]

Terminal Shape	Subject Series
Surface Mount Type	MVA(~63V _{dc}), MVE(~63V _{dc}), MZR, MZJ, MZA, MVY(6.3 ~ 63V _{dc}), MZF, MZE, MZK, MLA, MLF, MLE, MLK, MVL, MVJ, MVH(~50V _{dc}), MHL, MHB, MHJ, MHK, MV-BP, MVK-BP
Radial Lead Type	SRM, KRE, KMA, SRG, KRG, KMQ(~100V _{dc}), SMG(~250V _{dc}), KMG(~250V _{dc}), SME-BP, KME-BP, LZA, LXZ, LXY, LXV, LE, FL, GPA, GVA, GXF, GXE(~50V _{dc}), GXL, GPD, GVD, LBK, LBG, LLA

When a capacitor is mounted closely flush on the PC board, a residual cleaning agent may be left in the gap between the body of the capacitor and PC board surface. Dry out the residue with a forced hot air of 50 to 85°C for 10 minutes or more.

6-2-3 Other Solvents

To avoid capacitor failures, do not use the following cleaning agents:

- Halogenated system: causes capacitor failures due to corrosion.
- Alkali system: corrodes (dissolves) the aluminum can case.
- Terpene and petroleum system: deteriorates the rubber seal materials.
- Xylene: deteriorates the rubber seal materials as well.
- Acetone: erases the markings printed on a capacitor.

6-3 Adhesive and Coating Material

To use adhesives and/or coating materials for aluminum electrolytic capacitors, make sure of the following conditions:

- a. Do not use any of adhesive or coating materials containing halogenated solvents.
- b. No flux residue nor stain is left between the rubber seal of a capacitor and PC board.
- c. Dry the capacitor to remove residual cleaning agents before applying adhesive and coating materials. Do not cover up the entire surface of the rubber seal of the capacitor with adhesive and coating materials.
- d. Improper heating and/or curing conditions for adhesives and coating materials may cause the sleeve to swell or shrink. Please consult us for proper conditions.

- e. For a non-solid aluminum electrolytic capacitor, covering up the entire surface of the rubber seal with resin mold materials will obstruct the normal diffusion of internal hydrogen gas from the capacitor and result in serious failures. Also, where the adhesive and coating materials contain a large amount of halogen ions, the halogen ions will contaminate the inside of the capacitor through the rubber seal materials, which cause the capacitor to become a failure.
- f. The outer sleeve of a capacitor may lose a gloss or whiten in appearance depending on solvent materials that the adhesive or coating materials contains.
- g. Some adhesives or coating materials contain organic solvent such as Xylene. Xylene can deteriorate the rubber seal materials, which cause the flux ingredients to penetrate into the capacitor.

7. Recovery Voltage

When a capacitor is once charged and discharged with both of the terminals short-circuiting and then left the terminals open for a while, a voltage across the capacitor spontaneously increases again. This is called "recovery voltage phenomenon". The mechanism for this phenomenon can be interpreted as follows:

When charged with a voltage, the dielectric produces some electrical changes within, and then the inside of the dielectric is electrified with the opposite polarities (dielectric polarization). The dielectric polarization occurs in both ways of proceeding rapidly and slowly. When a charged capacitor was discharged until the voltage across the capacitor disappears, and then being left the terminals open, the slow polarization will discharge within the capacitor and appear as recovery voltage. (Fig. 28).

The recovery voltage changes with time as shown in Fig. 29. Its peak will appear 10 to 20 days after the terminals are opened, with gradual weakening thereafter. Larger sized capacitors (screw terminal type and snap-in type) may produce larger recovery voltage.

With a recovery voltage residing in a capacitor, carelessly short-circuiting the terminals can cause sparks to occur, which may scare workers and/or damage low-voltage operating components such as CPU's and memories in the device circuit. To avoid this trouble, discharge the capacitor through 100 - 1kΩ resistors before use. Also, Nippon Chemi-Con may provide some solutions with some packaging method for it. Please consult us.

6-4 Effect of Fumigation

In exporting or importing electronic devices, they may be exposed to fumigation with halide such as methyl bromide. Where aluminum electrolytic capacitors exposed to halide such as methyl bromide, the capacitors will be damaged with the corrosion reaction with the halogen ions.

For the export and import, Nippon Chemi-Con considers using some packaging method and so forth that the fumigation is not required to. For customers to export or import electronic devices, semi-assembly products or capacitor components, confirm if they will be exposed to fumigation and also consider final condition of packaging. (Note that either cardboard or vinyl package has a risk of fumigation gas penetration.)

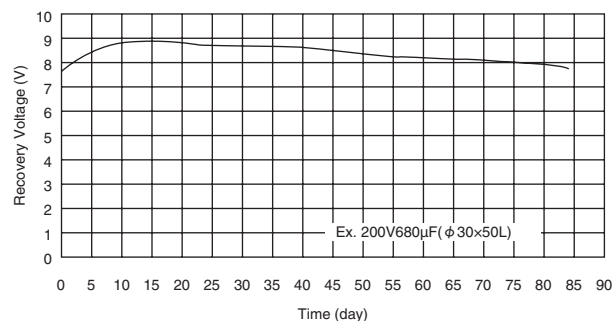
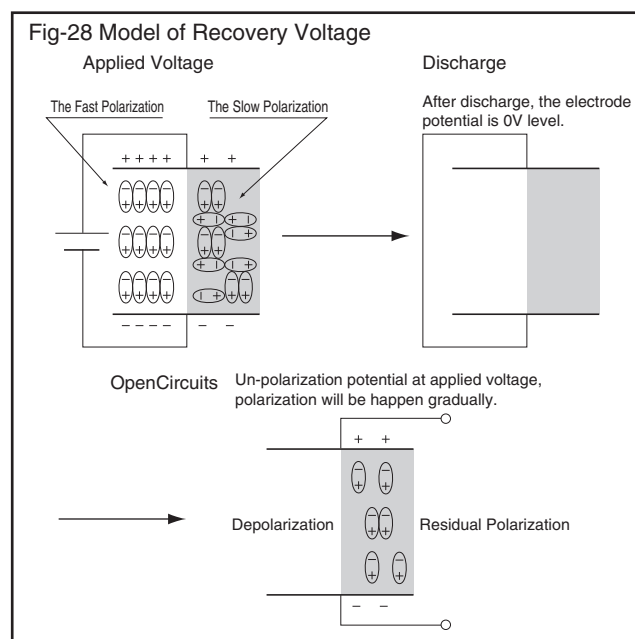

Fig-29 Change of Recovery Voltage



8. Storage

Some characteristics of an aluminum electrolytic capacitor are temperature-dependent. The higher the temperature is, the more deteriorated the capacitor will be. An increase in temperature accelerates the increase in leakage current and $\tan\delta$ and the decrease in capacitance. Leaving a capacitor exposed to high humidity for long hours may lead to discoloration of the lead wires and terminals, and poor solderability. To store aluminum electrolytic capacitors, keep them at normal temperature and humidity without exposure to direct sunlight.

Leaving them exposed to high temperatures (higher than the normal ambient temperature) for long periods of time may lead to chemical reactions between the anode oxide layer and electrolyte, which drop the withstanding voltage and increase leakage current. If this is the case, applying the rated voltage to the capacitor will lead to dielectric breakdown due to the heat produced with the large leakage current, which finally causes the pressure relief vent to open.

Capacitors that have been stored for long periods of time should be subjected to a voltage treatment process (see Note 1) which will reform the dielectric (Al_2O_3) by electrolyte and return the leakage current to the initial level. Leakage current increase during storage will vary with the withstanding voltage of a capacitor. In general, the higher the rated voltage, the larger increased the leakage current tends to be. Also, since storing for long period of time may shorten the lifetime of the capacitors, consider storage conditions according to the requirements of device life expectancy.

(Note 1) In the voltage treatment process, connecting resistor (around $1k\Omega$) in series with the capacitor, applied the rated voltage and then be kept the rated voltage for 30 to 60 minutes.

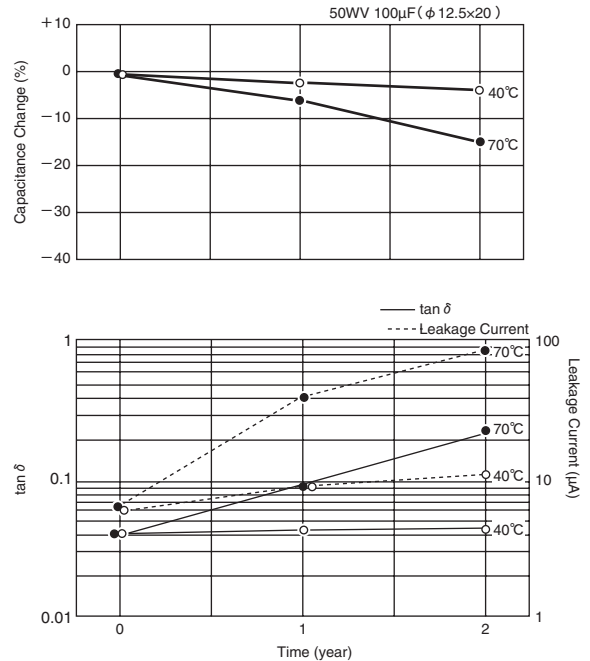

Fig-30 Temperature Characteristics of Storage



9. Tips for Selecting Capacitors Appropriate for Individual Applications

Aluminum electrolytic capacitors are used mainly for the filtering application of power supplies. Select appropriate capacitors for the specific requirements of each application, referring to the following examples for typical applications:

9-1 Input Filtering Capacitors for Switching Mode Power Supplies

An input filtering capacitor functions to smooth 50-120 Hz waveforms that come from a rectifying circuit, the waveforms of which are superimposed with the ripples with the switching frequency from the switching stage where the capacitor supplies the electric power. Therefore, the capacitor must be capable of managing both ripple currents with each frequency. The ESR of a capacitor is frequency-dependent, so that a ripple current of different frequency produces a different thermal energy in the capacitor.

For PFC power supplies or lighting ballasts, capacitors are subjected to ripple current whose frequency is several dozens of kHz to 100kHz. Therefore, to select capacitors, take their impedance characteristics into consideration.

● Recommended input filtering capacitors for SMPS

Characteristics Type	85°C		105°C		
	Standard	Longer Life	Standard	Compact	Longer Life
Radial Lead	—	—	KMQ	PAG	KXJ
Snap-in	SMQ	SMM	KMQ	KMS,KMR	LXS,LXM

9-2 Output Filtering Capacitors for Switching Mode Power Supplies

In the output filtering, a capacitor must be capable of managing a ripple current with the frequency as high as around 100 kHz. Therefore, Nippon Chemi-Con provides excellent product line-ups with low impedance characteristic at high frequencies, including high temperature and long-life versions, which can be chosen according to the application purpose.

The 125°C maximum temperature series capacitors have a shorter lifetime than the "Long Life" series of 105°C max. temperature though the electrical characteristics are highly stable. The "wide temperature range" series has two subseries that differ by the applicable temperature range: -55 to 105°C and -40 to 125°C. The "Long Life" series capacitors have been designed for specializing lower impedance and also longer lifetime. Compared to the "wide temperature range" series, the Long Life series can serve longer with the lower impedance, though the maximum operating temperature is limited to 105°C and the electrical characteristics are large in change over the temperature range.

● Recommended output filtering capacitors for SMPS

Characteristics Type	105°C		125°C
	Standard	Low Z	High Temp
Wide Temp Range	LXY	LXZ	GXE
Longer Life	KY	KZM,KZN	—

9-3 Filtering Capacitors for Inverter Main Circuits

These capacitors are used in a similar way to those for the input of the switching mode power supplies. Additionally, please understand the following precautions:

For the filtering circuit for 400Vac line, two capacitors of each a rated voltage 350 to 400Vdc can be used with being connected in series. In the series connection, voltages across the individual capacitors during charging depend on their individual capacitance values. After completion of the charging, the voltages come to depend on their leakage current values as the voltage distribution to the individual capacitors inversely corresponds to their leakage current values. For the voltage not to exceed the rated value after the charging is completed, balancing resistors should be connected in parallel with each capacitor. For guidance on choosing balancing resistors, please consult us.

Where capacitors connected in series are frequently charged and discharged, individual charging voltages depend on the variations in their capacitance values. Therefore, keeping the voltage balance will be difficult even if balancing resistors are employed. For servo amplifiers and other application where the voltage fluctuates frequently due to regeneration, use capacitor families that have been especially designed for intensive charge and discharge operations, or consult us for individual designs.

● Recommended capacitors for inverter main circuits

Characteristics Type	85°C		105°C	
	Standard	Longer Life	Standard	Longer Life
Snap-in	SMQ	SMM	KMQ	LXS,LXM
Screw Mount	RWE	RWF,RWG,RWH	KMH	LXA,LXR

● Recommended capacitors for servo amplifiers

Characteristics Type	85°C	105°C
	Standard	High Temp
Snap-in	—	KMV
Screw Mount	RWV	—

9-4 Capacitors for Control Circuits

These capacitors are relatively small in capacitance, and therefore the case size is also small. However, the smaller the case size, the shorter the lifetime of a capacitor. Moreover, if a capacitor is located near a heat source, the capacitor's lifetime may be shortened. Consider selecting an adequate capacitor in lifetime balancing with other capacitors.

● Recommended capacitors for control circuits

Characteristics Type	105°C	
	5L, 7L	11L
Radial Lead	FL	KY,KYB,LE

9-5 Photoflash Capacitors

These capacitors are specially designed so that much higher energy-volumetric efficiency can be obtained. Therefore, these capacitors are limited in application. Note that they cannot substitute filtering capacitors. Detailed specifications of these capacitors should be determined specifically for each photoflash application through discussions with a customer.

Reliability Test Data



MVL Series

MVH Series

●105°C Endurance

- MVL 6.3V 22 μ F D60
- △ MVL 50V 4.7 μ F E60
- × MVL 16V 47 μ F E60

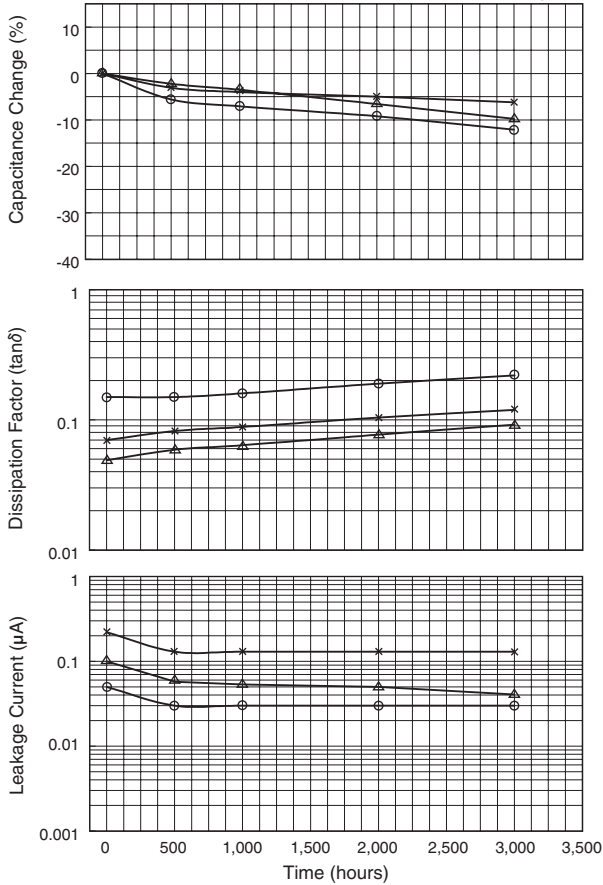

●125°C Endurance

- MVH 10V 220 μ F HA0
- △ MVH 35V 47 μ F HA0
- × MVH 50V 33 μ F HA0

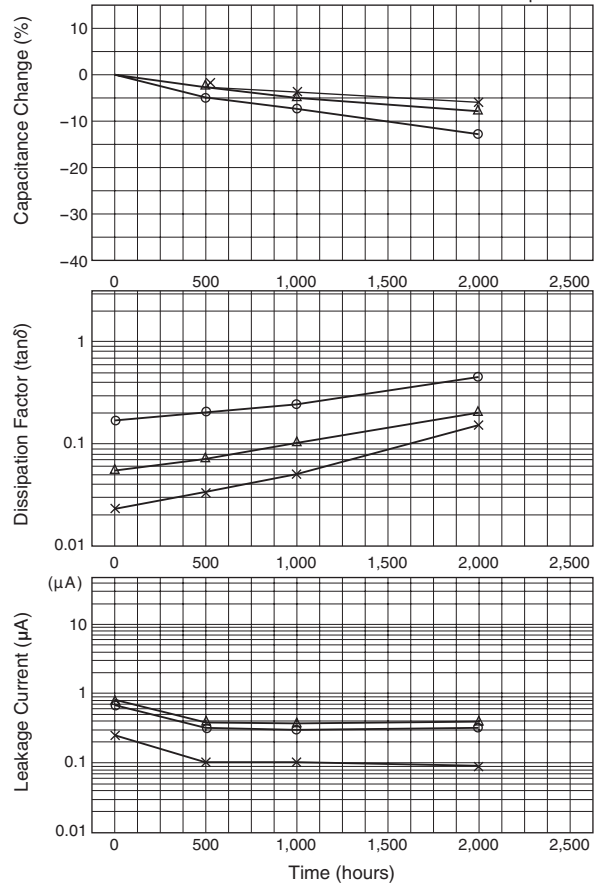

MVY Series

●Impedance/ESR vs Frequency

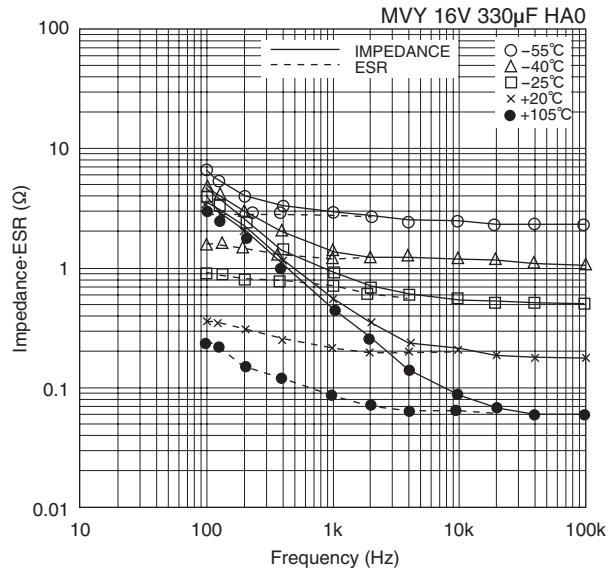
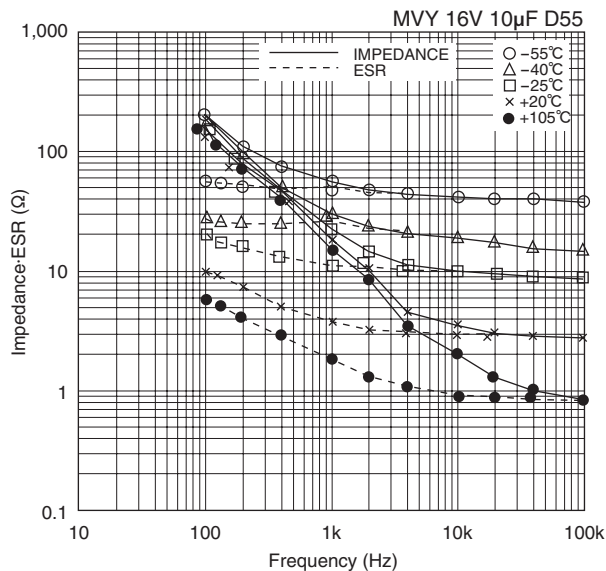



●105°C Endurance with Rated Ripple Current

○KZE 10V 220 μ F ϕ 6.3 \times 11L
 △KZE 16V 680 μ F ϕ 10 \times 16L
 □KZE 50V 470 μ F ϕ 12.5 \times 20L

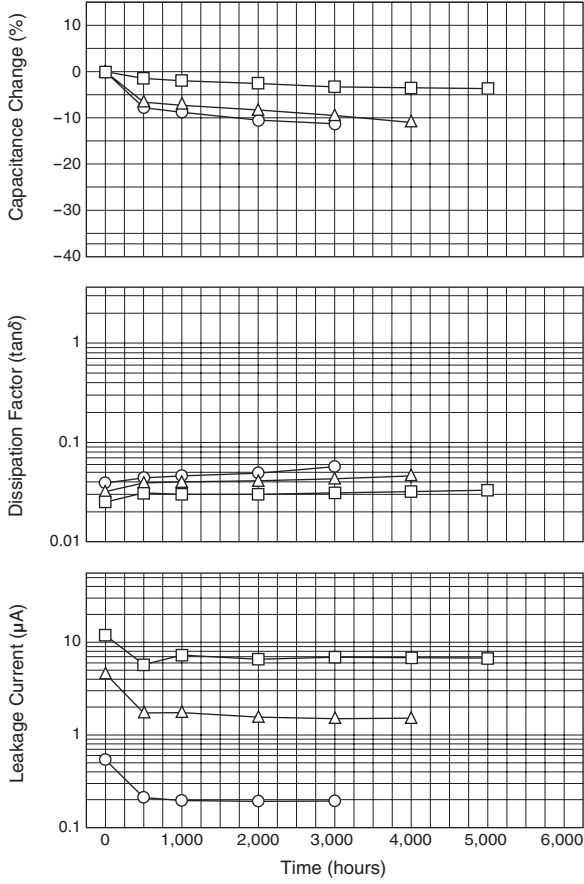

●105°C Shelf Life

○KZE 10V 220 μ F ϕ 6.3 \times 11L
 △KZE 16V 680 μ F ϕ 10 \times 16L
 □KZE 50V 470 μ F ϕ 12.5 \times 20L

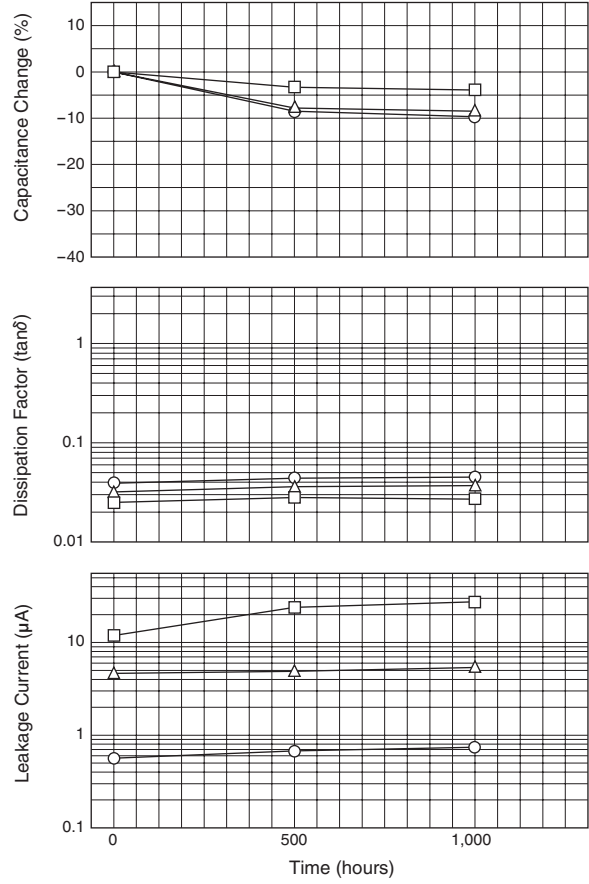

●Impedance-Frequency Characteristics

○KZE 10V 220 μ F ϕ 6.3 \times 11L
 △KZE 16V 680 μ F ϕ 10 \times 16L
 □KZE 50V 470 μ F ϕ 12.5 \times 20L at 20°C

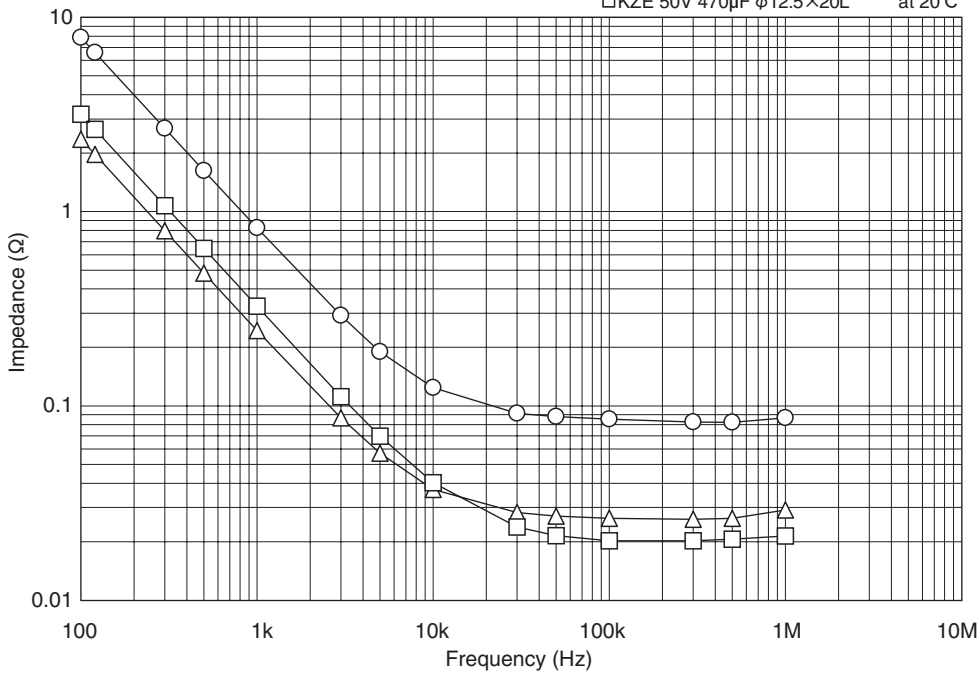



LXZ Series

LXY Series

●105°C Endurance with Rated Ripple Current

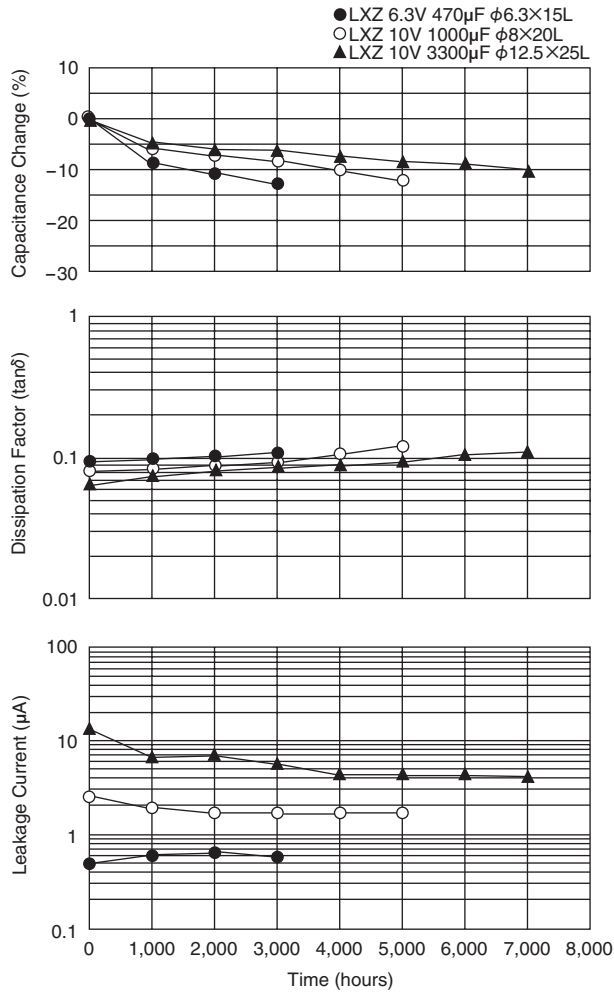

●105°C Endurance with Rated Ripple Current

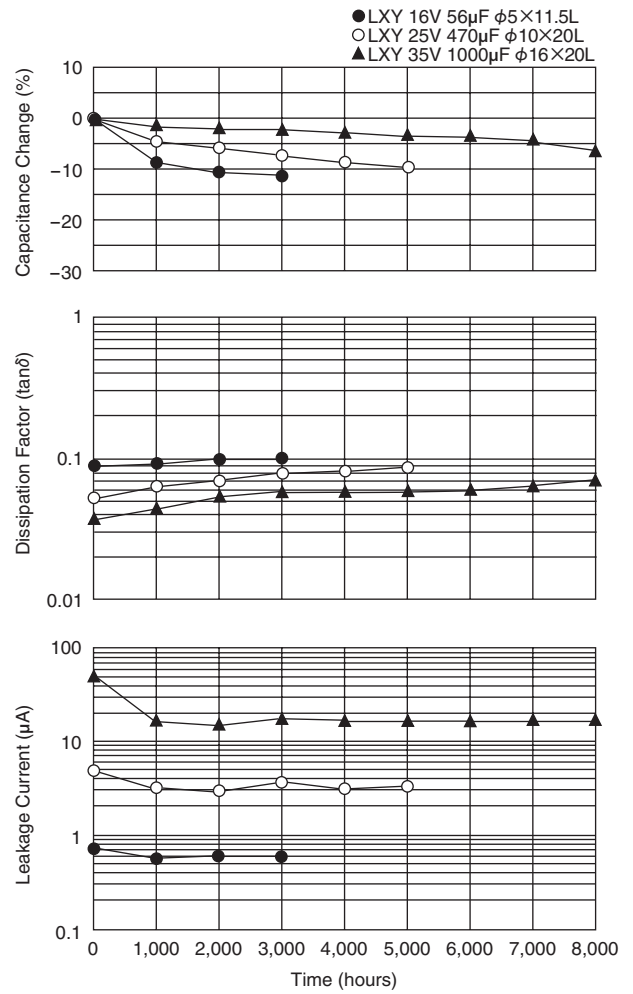

●Impedance-Frequency Characteristics

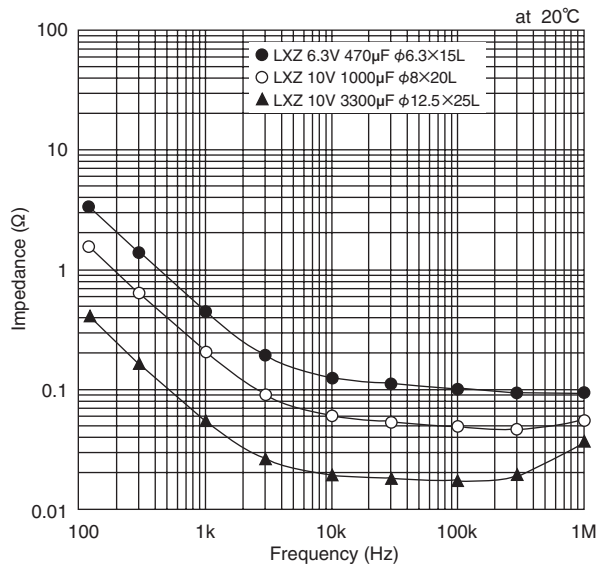

●Impedance-Frequency Characteristics

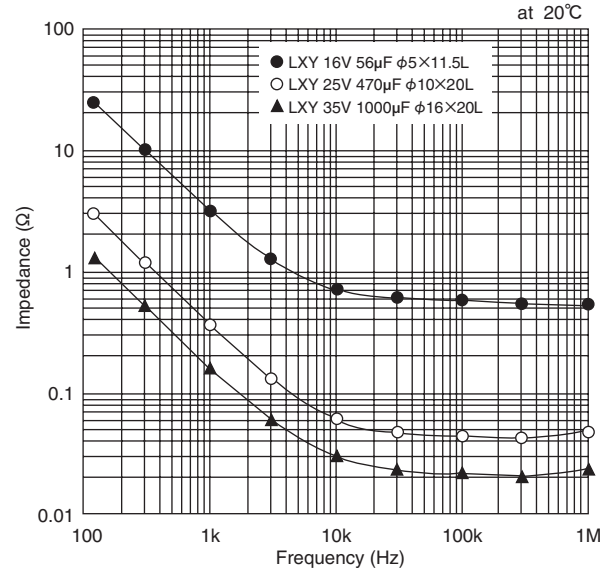



LXV Series

- LXV 10V 820μF φ5×11.5L
- LXV 25V 220μF φ8×15L
- ▲ LXV 35V 560μF φ12.5×20L

●105°C Endurance with Rated Ripple Current

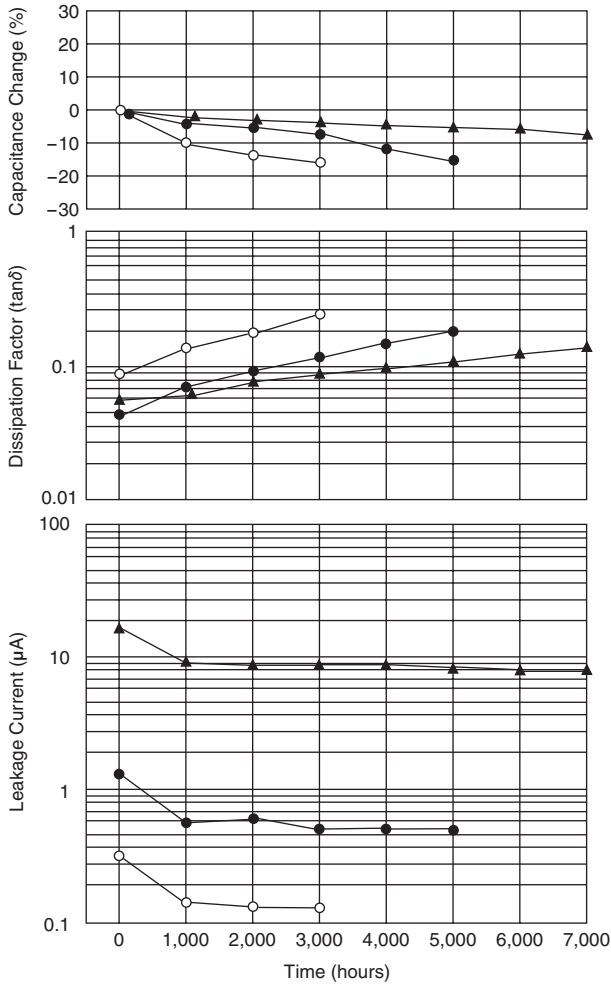

●105°C Shelf Life

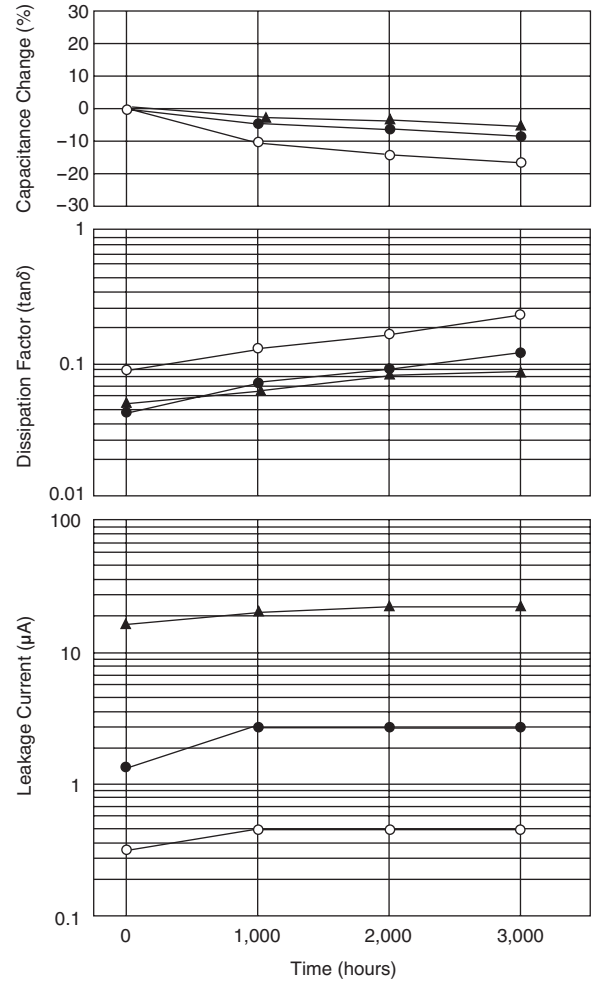

●Temperature Characteristics

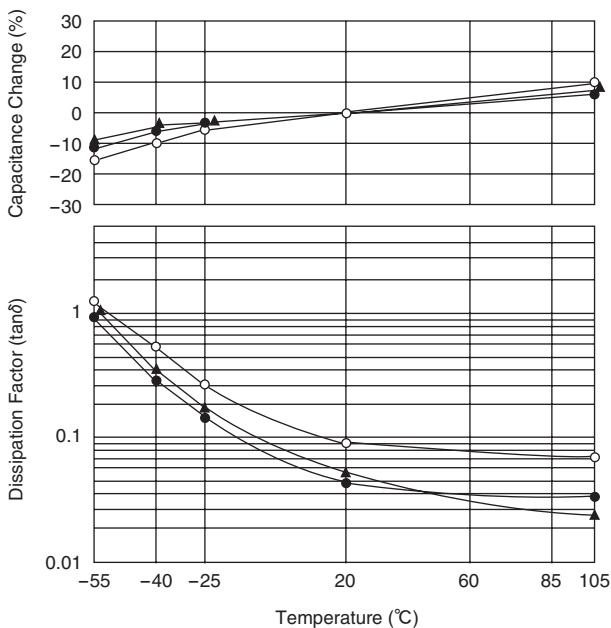

●Impedance-Frequency Characteristics

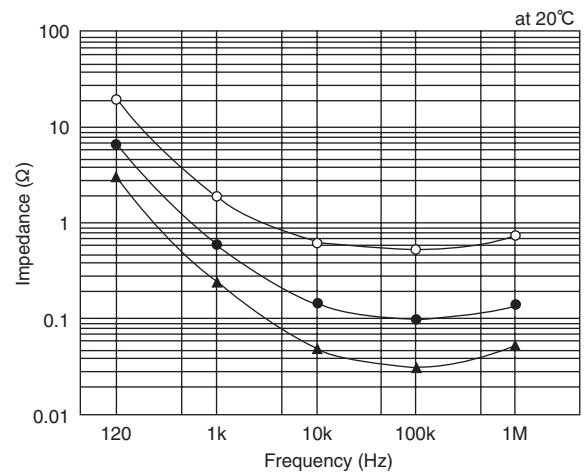



● 125°C Endurance with Rated Ripple Current

- GXE 35V 100μF φ8×12L
- △ GXE 50V 100μF φ10×12.5L
- GXE 10V 3300μF φ16×25L

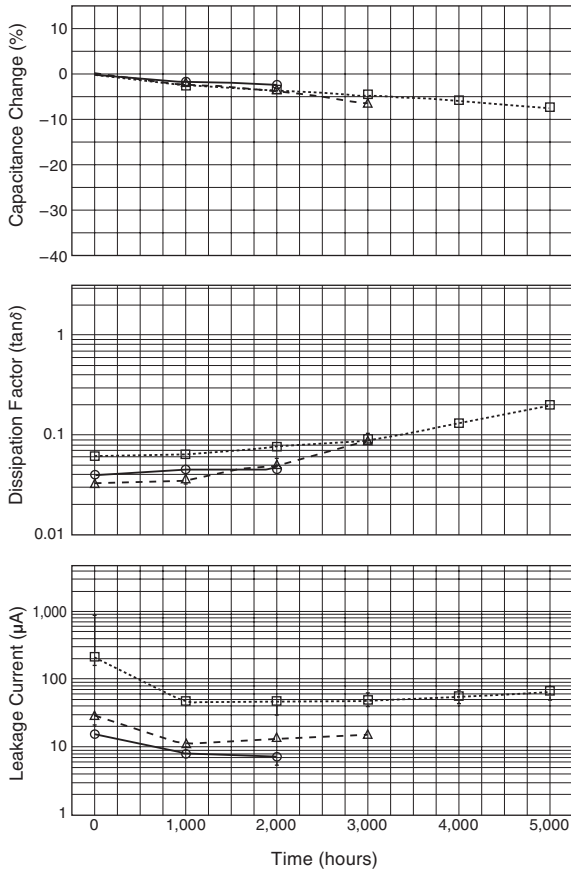

● Impedance-Frequency Characteristics

- GXE 35V 100μF φ8×12L
- △ GXE 50V 100μF φ10×12.5L
- GXE 10V 3300μF φ16×25L at 20°C

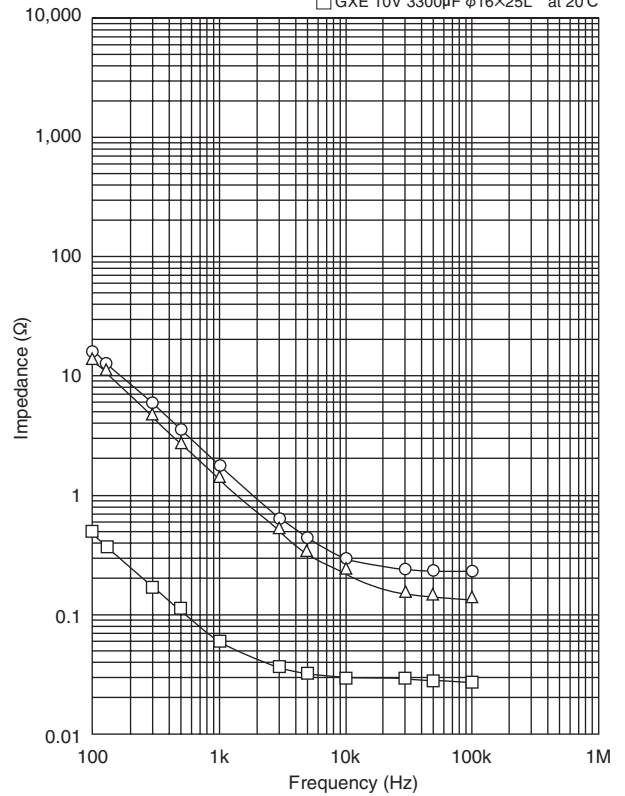



SMM Series

●85°C Endurance with Rated Ripple Current

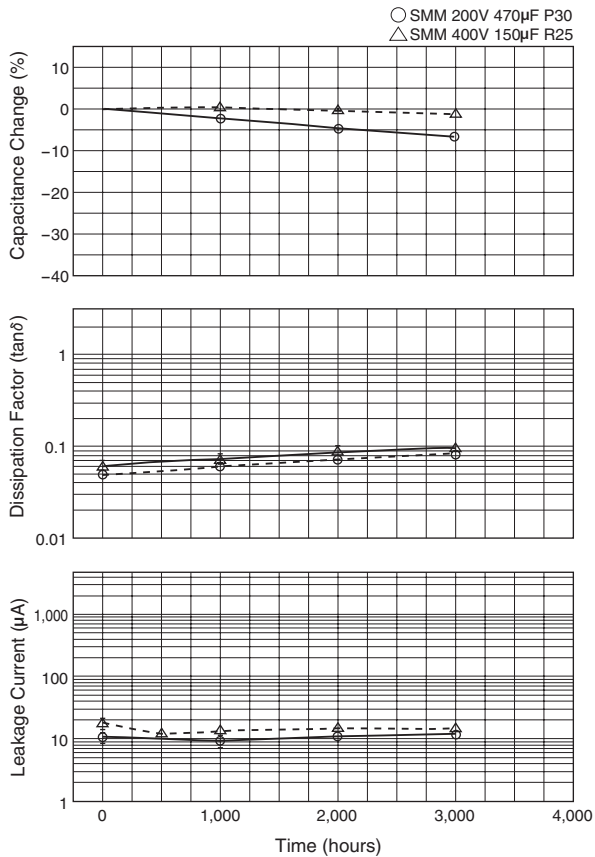

KMM Series

●105°C Endurance with Rated Ripple Current

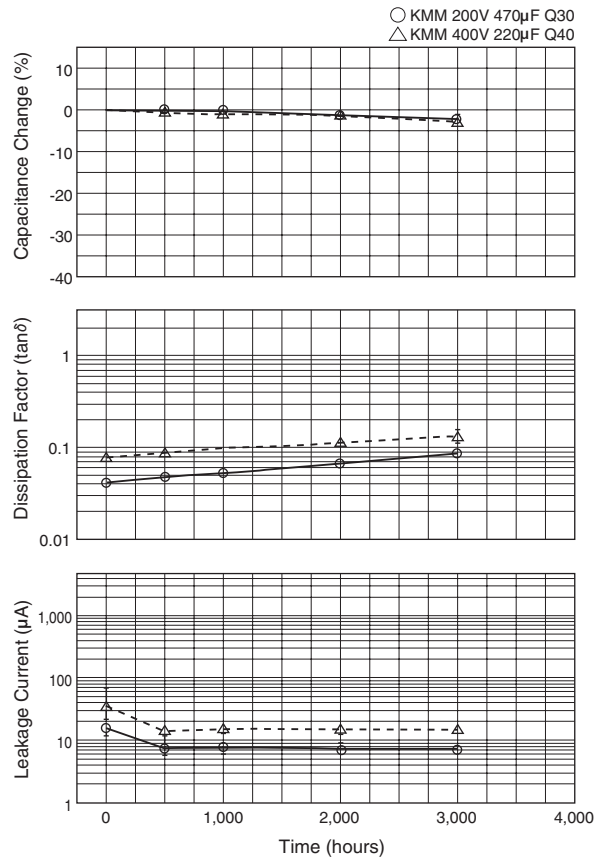

LXG Series

●105°C Endurance with Rated Ripple Current

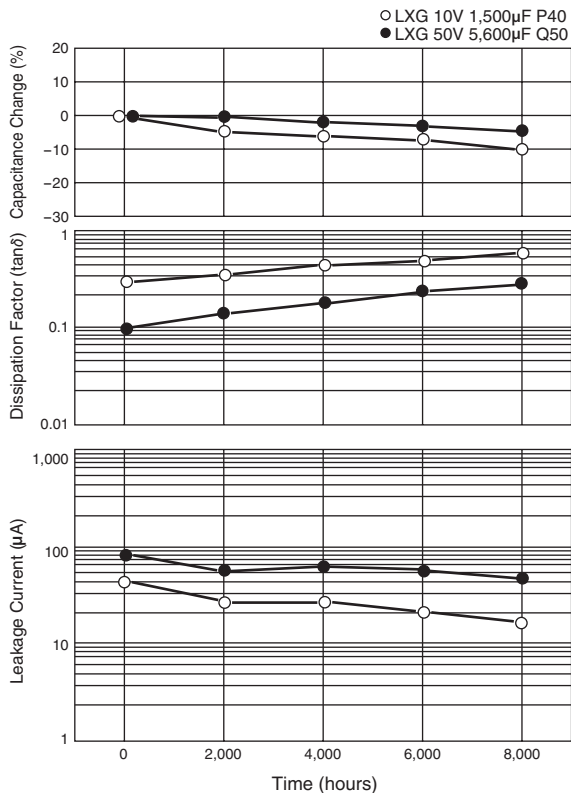

LXH Series

●105°C Endurance with Rated Ripple Current

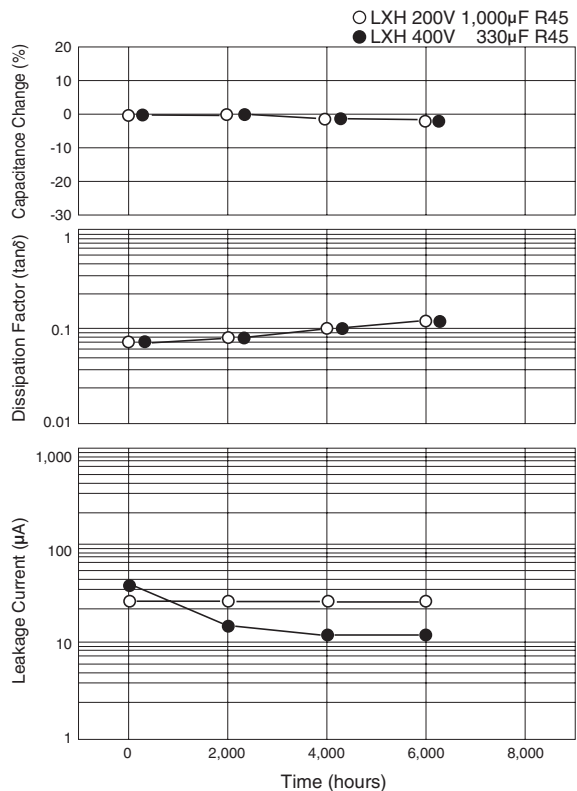



RWE/RWF/RWL Series

RWE/RWF series

●85°C Endurance with Rated Ripple Current

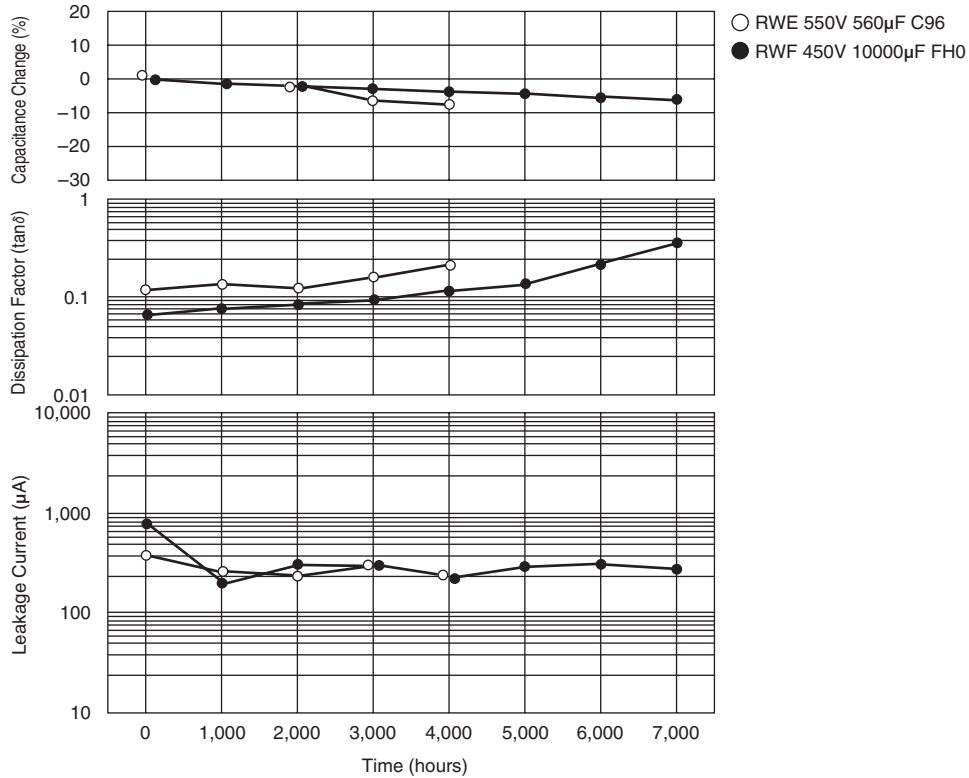

RWL series

●85°C Endurance with Rated Ripple Current

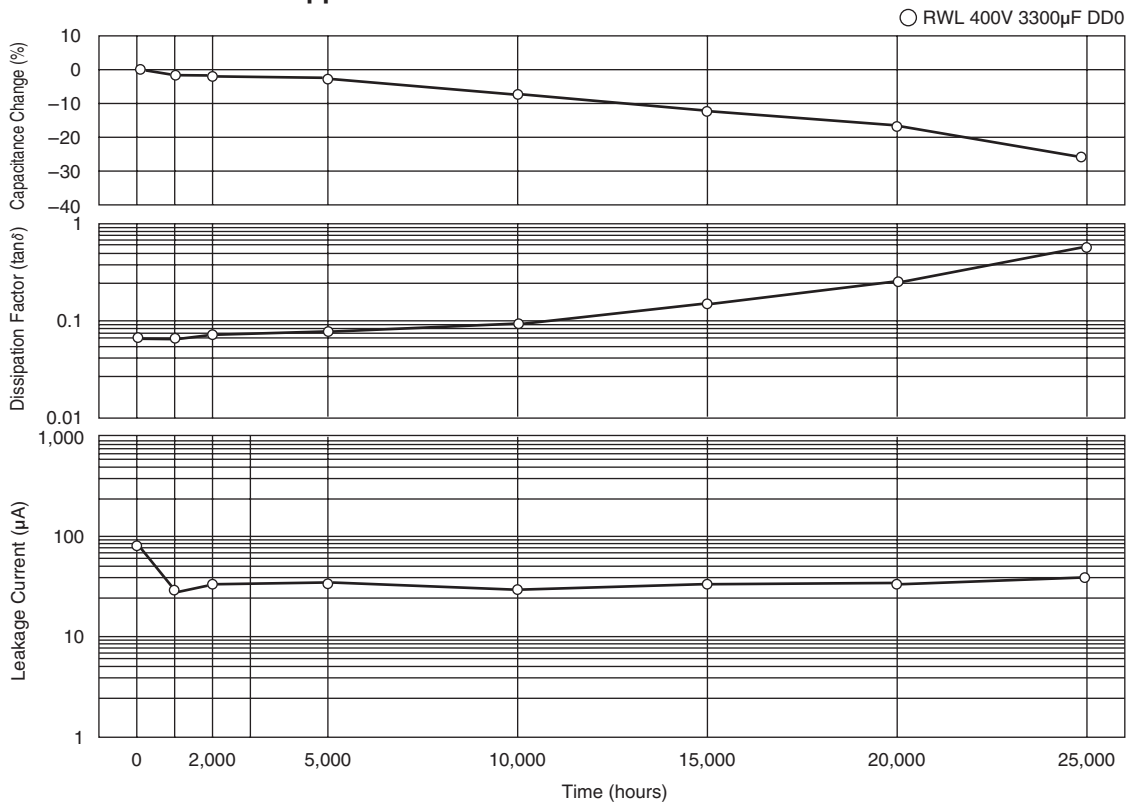

Appendix



PART NUMBERING SYSTEM

Appendix (Part number)

◆ Capacitance code

* How to use the table

2nd	1st Cap. Value
-----	-------------------

Capacitance value part

2nd	1st								
	1	2	3	4	5	6	7	8	9
0	10.0	20.0	30.0	40.0	50.0	60.0	70.0	80.0	90.0
A	10.5	20.5	30.5	40.5	50.5	60.5	70.5	80.5	90.5
1	11.0	21.0	31.0	41.0	51.0	61.0	71.0	81.0	91.0
B	11.5	21.5	31.5	41.5	51.5	61.5	71.5	81.5	91.5
2	12.0	22.0	32.0	42.0	52.0	62.0	72.0	82.0	92.0
C	12.5	22.5	32.5	42.5	52.5	62.5	72.5	82.5	92.5
3	13.0	23.0	33.0	43.0	53.0	63.0	73.0	83.0	93.0
D	13.5	23.5	33.5	43.5	53.5	63.5	73.5	83.5	93.5
4	14.0	24.0	34.0	44.0	54.0	64.0	74.0	84.0	94.0
E	14.5	24.5	34.5	44.5	54.5	64.5	74.5	84.5	94.5
5	15.0	25.0	35.0	45.0	55.0	65.0	75.0	85.0	95.0
F	15.5	25.5	35.5	45.5	55.5	65.5	75.5	85.5	95.5
6	16.0	26.0	36.0	46.0	56.0	66.0	76.0	86.0	96.0
G	16.5	26.5	36.5	46.5	56.5	66.5	76.5	86.5	96.5
7	17.0	27.0	37.0	47.0	57.0	67.0	77.0	87.0	97.0
H	17.5	27.5	37.5	47.5	57.5	67.5	77.5	87.5	97.5
8	18.0	28.0	38.0	48.0	58.0	68.0	78.0	88.0	98.0
J	18.5	28.5	38.5	48.5	58.5	68.5	78.5	88.5	98.5
9	19.0	29.0	39.0	49.0	59.0	69.0	79.0	89.0	99.0
K	19.5	29.5	39.5	49.5	59.5	69.5	79.5	89.5	99.5



For less than 10μF, a decimal point position is displayed with R.

For 10μF or more, capacitance code is set to the first 2 digits and index (1 digit).

Treatment of fraction (Refer to the table)

Example of conversion

Real cap.	The first 2 digits	Treatment of fraction	Code		
			11th	12th	13th
10.0μF →	10.0 →	10.0 →	1	0	0
10.1μF →	10.1 →	10.0 →	1	0	0
10.2μF →	10.2 →	10.0 →	1	0	0
10.3μF →	10.3 →	10.5 →	1	A	0
10.4μF →	10.4 →	10.5 →	1	A	0
10.5μF →	10.5 →	10.5 →	1	A	0
10.6μF →	10.6 →	10.5 →	1	A	0
10.7μF →	10.7 →	10.5 →	1	A	0
10.8μF →	10.8 →	11.0 →	1	1	0
10.9μF →	10.9 →	11.0 →	1	1	0
11.0μF →	11.0 →	11.0 →	1	1	0
132μF →	13.2 →	13.0 →	1	3	1
133μF →	13.3 →	13.5 →	1	D	1
167μF →	16.7 →	16.5 →	1	G	1
168μF →	16.8 →	17.0 →	1	7	1
1110μF →	11.1 →	11.0 →	1	1	2
1340μF →	13.4 →	13.5 →	1	D	2
13200μF →	13.2 →	13.0 →	1	3	3
13600μF →	13.6 →	13.5 →	1	D	3
270000μF →	27.0 →	27.0 →	2	7	4

◆ Case length (Radial lead type)

Case length [mm]	16th	17th	Case length [mm]	16th	17th	Case length [mm]	16th	17th	Case length [mm]	16th	17th	Case length [mm]	16th	17th
0.0	—	—	1.0	0	1	2.0	0	2	3.0	0	3	4.0	0	4
0.1	0	B	1.1	1	B	2.1	2	B	3.1	3	B	4.1	4	B
0.2	0	C	1.2	1	C	2.2	2	C	3.2	3	C	4.2	4	C
0.3	0	D	1.3	1	D	2.3	2	D	3.3	3	D	4.3	4	D
0.4	0	E	1.4	1	E	2.4	2	E	3.4	3	E	4.4	4	E
0.5	0	F	1.5	1	F	2.5	2	F	3.5	3	F	4.5	4	F
0.6	0	G	1.6	1	G	2.6	2	G	3.6	3	G	4.6	4	G
0.7	0	H	1.7	1	H	2.7	2	H	3.7	3	H	4.7	4	H
0.8	0	J	1.8	1	J	2.8	2	J	3.8	3	J	4.8	4	J
0.9	0	K	1.9	1	K	2.9	2	K	3.9	3	K	4.9	4	K
5.0	0	5	6.0	0	6	7.0	0	7	8.0	0	8	9.0	0	9
5.1	5	B	6.1	6	B	7.1	7	B	8.1	8	B	9.1	9	B
5.2	5	C	6.2	6	C	7.2	7	C	8.2	8	C	9.2	9	C
5.3	5	D	6.3	6	D	7.3	7	D	8.3	8	D	9.3	9	D
5.4	5	E	6.4	6	E	7.4	7	E	8.4	8	E	9.4	9	E
5.5	5	F	6.5	6	F	7.5	7	F	8.5	8	F	9.5	9	F
5.6	5	G	6.6	6	G	7.6	7	G	8.6	8	G	9.6	9	G
5.7	5	H	6.7	6	H	7.7	7	H	8.7	8	H	9.7	9	H
5.8	5	J	6.8	6	J	7.8	7	J	8.8	8	J	9.8	9	J
5.9	5	K	6.9	6	K	7.9	7	K	8.9	8	K	9.9	9	K
10.0	1	0	11.0	1	1	12.0	1	2	13.0	1	3	14.0	1	4
10.1	A	1	11.1	B	1	12.1	C	1	13.1	D	1	14.1	E	1
10.2	A	2	11.2	B	2	12.2	C	2	13.2	D	2	14.2	E	2
10.3	A	3	11.3	B	3	12.3	C	3	13.3	D	3	14.3	E	3
10.4	A	4	11.4	B	4	12.4	C	4	13.4	D	4	14.4	E	4
10.5	A	5	11.5	B	5	12.5	C	5	13.5	D	5	14.5	E	5
10.6	A	6	11.6	B	6	12.6	C	6	13.6	D	6	14.6	E	6
10.7	A	7	11.7	B	7	12.7	C	7	13.7	D	7	14.7	E	7
10.8	A	8	11.8	B	8	12.8	C	8	13.8	D	8	14.8	E	8
10.9	A	9	11.9	B	9	12.9	C	9	13.9	D	9	14.9	E	9

Return Group Chart



PART NUMBERING SYSTEM

Case length [mm]	16th	17th
15.0	1	5
15.1	F	1
15.2	F	2
15.3	F	3
15.4	F	4
15.5	F	5
15.6	F	6
15.7	F	7
15.8	F	8
15.9	F	9

Case length [mm]	16th	17th
16.0	1	6
16.1	G	1
16.2	G	2
16.3	G	3
16.4	G	4
16.5	G	5
16.6	G	6
16.7	G	7
16.8	G	8
16.9	G	9

Case length [mm]	16th	17th
17.0	1	7
17.1	H	1
17.2	H	2
17.3	H	3
17.4	H	4
17.5	H	5
17.6	H	6
17.7	H	7
17.8	H	8
17.9	H	9

Case length [mm]	16th	17th
18.0	1	8
18.1	J	1
18.2	J	2
18.3	J	3
18.4	J	4
18.5	J	5
18.6	J	6
18.7	J	7
18.8	J	8
18.9	J	9

Case length [mm]	16th	17th
19.0	1	9
19.1	K	1
19.2	K	2
19.3	K	3
19.4	K	4
19.5	K	5
19.6	K	6
19.7	K	7
19.8	K	8
19.9	K	9

Case length [mm]	16th	17th
20.0	2	0
20.5	L	1
21.0	2	1
21.5	L	3
22.0	2	2
22.5	L	5
23.0	2	3
23.5	L	7
24.0	2	4
24.5	L	9
25.0	2	5
25.5	M	1
26.0	2	6
26.5	M	3
27.0	2	7
27.5	M	5
28.0	2	8
28.5	M	7
29.0	2	9
29.5	M	9

Case length [mm]	16th	17th
30.0	3	0
30.5	N	1
31.0	3	1
31.5	N	3
32.0	3	2
32.5	N	5
33.0	3	3
33.5	N	7
34.0	3	4
34.5	N	9
35.0	3	5
35.5	P	1
36.0	3	6
36.5	P	3
37.0	3	7
37.5	P	5
38.0	3	8
38.5	P	7
39.0	3	9
39.5	P	9

Case length [mm]	16th	17th
40.0	4	0
40.5	Q	1
41.0	4	1
41.5	Q	3
42.0	4	2
42.5	Q	5
43.0	4	3
43.5	Q	7
44.0	4	4
44.5	Q	9
45.0	4	5
45.5	R	1
46.0	4	6
46.5	R	3
47.0	4	7
47.5	R	5
48.0	4	8
48.5	R	7
49.0	4	9
49.5	R	9

Case length [mm]	16th	17th
50.0	5	0
50.5	S	1
51.0	5	1
51.5	S	3
52.0	5	2
52.5	S	5
53.0	5	3
53.5	S	7
54.0	5	4
54.5	S	9
55.0	5	5
55.5	T	1
56.0	5	6
56.5	T	3
57.0	5	7
57.5	T	5
58.0	5	8
58.5	T	7
59.0	5	9
59.5	T	9

Case length [mm]	16th	17th
60.0	6	0
60.5	U	1
61.0	6	1
61.5	U	3
62.0	6	2
62.5	U	5
63.0	6	3
63.5	U	7
64.0	6	4
64.5	U	9
65.0	6	5
65.5	V	1
66.0	6	6
66.5	V	3
67.0	6	7
67.5	V	5
68.0	6	8
68.5	V	7
69.0	6	9
69.5	V	9

Case length [mm]	16th	17th
70.0	7	0
70.5	W	1
71.0	7	1
71.5	W	3
72.0	7	2
72.5	W	5
73.0	7	3
73.5	W	7
74.0	7	4
74.5	W	9
75.0	7	5
75.5	X	1
76.0	7	6
76.5	X	3
77.0	7	7
77.5	X	5
78.0	7	8
78.5	X	7
79.0	7	9
79.5	X	9

Case length [mm]	16th	17th
80.0	8	0
80.5	Y	1
81.0	8	1
81.5	Y	3
82.0	8	2
82.5	Y	5
83.0	8	3
83.5	Y	7
84.0	8	4
84.5	Y	9
85.0	8	5
85.5	Z	1
86.0	8	6
86.5	Z	3
87.0	8	7
87.5	Z	5
88.0	8	8
88.5	Z	7
89.0	8	9
89.5	Z	9



PART NUMBERING SYSTEM

◆ Case length (Snap-in type / Screw mount terminal type)

Case length [mm]	16th	17th	Case length [mm]	16th	17th	Case length [mm]	16th	17th	Case length [mm]	16th	17th	Case length [mm]	16th	17th
20	2	0	30	3	0	40	4	0	50	5	0	60	6	0
21	2	1	31	3	1	41	4	1	51	5	1	61	6	1
22	2	2	32	3	2	42	4	2	52	5	2	62	6	2
23	2	3	33	3	3	43	4	3	53	5	3	63	6	3
24	2	4	34	3	4	44	4	4	54	5	4	64	6	4
25	2	5	35	3	5	45	4	5	55	5	5	65	6	5
26	2	6	36	3	6	46	4	6	56	5	6	66	6	6
27	2	7	37	3	7	47	4	7	57	5	7	67	6	7
28	2	8	38	3	8	48	4	8	58	5	8	68	6	8
29	2	9	39	3	9	49	4	9	59	5	9	69	6	9
Case length [mm]	16th	17th	Case length [mm]	16th	17th	Case length [mm]	16th	17th	Case length [mm]	16th	17th	Case length [mm]	16th	17th
70	7	0	80	8	0	90	9	0	100	A	0	110	B	0
71	7	1	81	8	1	91	9	1	101	A	1	111	B	1
72	7	2	82	8	2	92	9	2	102	A	2	112	B	2
73	7	3	83	8	3	93	9	3	103	A	3	113	B	3
74	7	4	84	8	4	94	9	4	104	A	4	114	B	4
75	7	5	85	8	5	95	9	5	105	A	5	115	B	5
76	7	6	86	8	6	96	9	6	106	A	6	116	B	6
77	7	7	87	8	7	97	9	7	107	A	7	117	B	7
78	7	8	88	8	8	98	9	8	108	A	8	118	B	8
79	7	9	89	8	9	99	9	9	109	A	9	119	B	9
Case length [mm]	16th	17th	Case length [mm]	16th	17th	Case length [mm]	16th	17th	Case length [mm]	16th	17th	Case length [mm]	16th	17th
120	C	0	130	D	0	140	E	0	150	F	0	160	G	0
121	C	1	131	D	1	141	E	1	151	F	1	161	G	1
122	C	2	132	D	2	142	E	2	152	F	2	162	G	2
123	C	3	133	D	3	143	E	3	153	F	3	163	G	3
124	C	4	134	D	4	144	E	4	154	F	4	164	G	4
125	C	5	135	D	5	145	E	5	155	F	5	165	G	5
126	C	6	136	D	6	146	E	6	156	F	6	166	G	6
127	C	7	137	D	7	147	E	7	157	F	7	167	G	7
128	C	8	138	D	8	148	E	8	158	F	8	168	G	8
129	C	9	139	D	9	149	E	9	159	F	9	169	G	9
Case length [mm]	16th	17th	Case length [mm]	16th	17th	Case length [mm]	16th	17th	Case length [mm]	16th	17th	Case length [mm]	16th	17th
170	H	0	180	J	0	190	K	0	200	L	0	210	M	0
171	H	1	181	J	1	191	K	1	201	L	1	211	M	1
172	H	2	182	J	2	192	K	2	202	L	2	212	M	2
173	H	3	183	J	3	193	K	3	203	L	3	213	M	3
174	H	4	184	J	4	194	K	4	204	L	4	214	M	4
175	H	5	185	J	5	195	K	5	205	L	5	215	M	5
176	H	6	186	J	6	196	K	6	206	L	6	216	M	6
177	H	7	187	J	7	197	K	7	207	L	7	217	M	7
178	H	8	188	J	8	198	K	8	208	L	8	218	M	8
179	H	9	189	J	9	199	K	9	209	L	9	219	M	9
Case length [mm]	16th	17th	Case length [mm]	16th	17th	Case length [mm]	16th	17th	Case length [mm]	16th	17th			
220	N	0	230	P	0	240	Q	0	250	R	0			
221	N	1	231	P	1	241	Q	1	251	R	1			
222	N	2	232	P	2	242	Q	2	252	R	2			
223	N	3	233	P	3	243	Q	3	253	R	3			
224	N	4	234	P	4	244	Q	4	254	R	4			
225	N	5	235	P	5	245	Q	5	255	R	5			
226	N	6	236	P	6	246	Q	6	256	R	6			
227	N	7	237	P	7	247	Q	7	257	R	7			
228	N	8	238	P	8	248	Q	8	258	R	8			
229	N	9	239	P	9	249	Q	9	259	R	9			



◆ Supplement code

Conductive polymer Chip and Radial lead type / Electrolytic Chip type

	Terminal plating material	
	Sn	Sn-Bi
Coating case	S	G

Radial lead type / Snap-in type

		Terminal plating material	
		Sn	Sn-Bi
Outer sleeve	PET	S	D
	Coating case	H	G
	Polyolefin	L	-
	Pb-free PVC	M	-

* Standard design of "environmental friendly" snap-in are not equipped with a plastic disk on the top of the can case.
 We also produce snap-in type with "Plastic disk, PVC sleeve and Sn terminal plating".
 In this case, supplement code (the 18th digit) is "T".

Screw mount terminal type

	Screw terminal
Pb-free PVC	M
Polyolefin	S
PET	C

ELECTRONIC COMPONENTS & DEVICES

PRODUCTS

	CAT.No.
Aluminum Electrolytic Capacitors	1001
Multilayer Ceramic Capacitors	1002
Film Capacitors	1003
Metal Oxide Varistors TNR™	1006
Amorphous / Dust Choke Coils	1008
Electric Double Layer Capacitors	1009
Electro-Mechanical Products	

Notes on Safety



- Always read "Notes on Use" before using the product in order to enable you to use the product correctly and prevent any faults and accidents from occurring.
- Request the Product Specification on the product of NIPPON CHEMI-CON CORPORATION to refer to it as well as this brochure prior to the order of the products. Some specific notes on use of the ordered product may be described in the specifications.

The electronic components described in this catalogue were designed and developed for use in general electronic equipment, such as ; general household appliances, office and AV equipment, information and communication equipment, etc.

We ask you, therefore, to appraise, examine and judge the suitability of these electronic components very carefully, or contact us, for designs that require higher levels of safety and reliability, such as ; medical or aerospace equipment, equipment related to nuclear power, safety devices for automotive products, or disaster prevention equipment.

When using these components for circuits in general electronic equipment that also require higher levels of safety and reliability, we recommend that you carry out a thorough appraisal of the component's intended use in the application and add any necessary protection networks during the design phase.

NIPPON CHEMI-CON CORPORATION

<http://www.chemi-con.co.jp/e/>



Distributed or Represented by